

# CW-C4000 Series

## Technical Reference Guide

---

### **Product Overview**

Describes features for the product.

### **Setup**

Describes setup and installation of the product.

### **Handling**

Describes how to handle the product.

### **Information for Application Development**

Describes how to control the printer and necessary information when you develop applications.

### **Appendix**

Describes specifications of the product.

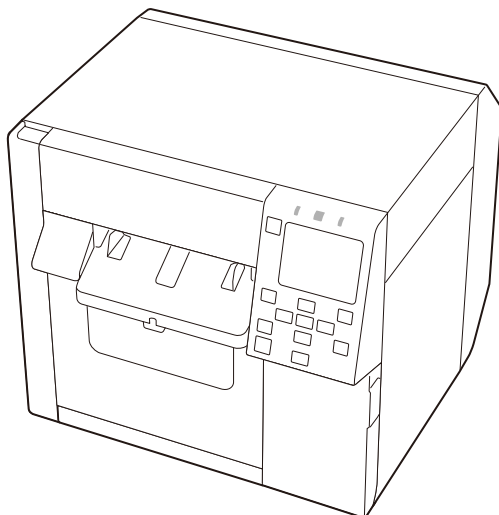

## Cautions

- All rights reserved. No part of this publication may be reproduced, stored in a retrieval system, or transmitted in any form or by any means, electronic, mechanical, photocopying, recording, or otherwise, without the prior written permission of Seiko Epson Corporation.
- The content of this manual is subject to change without notice. Please contact us for the latest information.
- While every precaution has been taken in the preparation of this manual, Seiko Epson Corporation assumes no responsibility for errors or omissions.
- Neither is any liability assumed for damages resulting from the use of the information contained herein.
- Neither Seiko Epson Corporation nor its affiliates shall be liable to the purchaser of this product or third parties for damages, losses, costs, or expenses incurred by purchaser or third parties as a result of: accident, misuse, or abuse of this product or unauthorized modifications, repairs, or alterations to this product, or (excluding the U.S.) failure to strictly comply with Seiko Epson Corporation's operating and maintenance instructions.
- Seiko Epson Corporation shall not be liable for any damages or problems arising from the use of any options or any consumable products other than those designated as Genuine Epson Products or Epson Approved Products by Seiko Epson Corporation.

## Trademarks

Microsoft® and Windows® are registered trademarks of Microsoft Corporation in the United States and/or other countries.

Mac, mac OS, OS X, and ColorSync are trademarks of Apple Inc., registered in the U.S. and other countries.

Zebra Technologies Corporation and ZPL II are the registered trademarks or trademarks of Zebra Technologies Corporation.

Pentium® is a trademark of Intel Corporation in the U.S. and/or other countries.

Adobe, the Adobe logo, Acrobat, Photoshop, PostScript and Reader are either registered trademarks or trademarks of Adobe in the United States and/or other countries.

IOS is a trademark or registered trademark of Cisco in the U.S. and other countries and is used under license.

Android™ is a trademark of Google LLC.

QR Code is a registered trademark of DENSO WAVE INCORPORATED in Japan and other countries.

BarTender® is registered trademark of Seagull Scientific, Inc. in the United States and other countries.

NiceLabel® and NiceLabel Cloud are registered trademarks or trademarks of Loftware.

CODESOFT is registered trademarks or trademarks of TEKLYNX International.

All other trademarks are the property of their respective owners and used for identification purpose only.

©Seiko Epson Corporation 2021–2023

# Before Use

This chapter describes information you should know before using the product.

## Manuals for This Product

### Paper manual

### Start Here



Guides you through basic setup steps from unpacking to loading paper.

---

### Manual viewable with PC

### User's Guide



Describes details about the functions and operating procedures of the product, maintenance information, and troubleshooting. Download this guide from the web site or, depending on the country or region, this is included in the supplied CD.

---

### Manual viewable with PC

### CW-C4000 Series Technical Reference Guide (This manual)



Provides information necessary for installing the product, performing daily tasks, and developing a system using the product.

---

### Manual viewable with PC

### Online Video Manual



Provides videos that show you operating procedures and troubleshooting information. Access the videos from the following URL.

<[https://support.epson.net/p\\_doc/968/](https://support.epson.net/p_doc/968/)>

The contents of videos are subject to change without notice.

---

## Downloading the Latest Version

The latest versions of the printer driver, utilities, and manuals can be downloaded from the following URLs.

For customers in North America, go to the following web site:

[https://support.epson.net/p\\_doc/96a/](https://support.epson.net/p_doc/96a/)

For customers in other countries and regions, go to the following web site:

<https://www.epson-biz.com/>



## Symbols Used in This Guide

The following symbols are used in this guide to indicate important information.

---



### Symbols for Safety

The symbols shown below are used in this manual in order to ensure safety and proper use of this product and to prevent danger to you and other persons, and property damage. Be sure that you completely understand their meanings before reading this manual.

 <b>WARNING</b>	Handling the product improperly by ignoring this symbol can lead to death or serious injury.
 <b>CAUTION</b>	Handling the product improperly by ignoring this symbol can lead to injury and property damage.

---

### Symbols for General Information

 <b>IMPORTANT</b>	Indicates information with which you must comply when using the product. Mishandling due to ignoring this information may cause the product to fail or malfunction.
	Indicates supplementary explanations and information you should know.

## Safety Precautions

To ensure safe use of the product, be sure to read this manual and the other instruction manuals supplied with the product before use. Store this manual in a safe place so that you can resolve any unclear points regarding the product at any time.

## Cautions on Installation



### WARNING

Do not cover the product with a cloth or install it in a poorly-ventilated location. Furthermore, ensure there is the installation space specified in the manual.



### CAUTION

- Do not install/store the product in an unstable location or in a location subject to vibration from other devices. The product may fall or collapse, causing breakage and possible injury.
- Do not install the product in a location exposed to oily smoke or dust, or in a humid location. Doing so may cause electric shock or fire.
- When lifting the product, perform the work with the correct posture. Lifting the product with an inappropriate posture may cause injury.
- Do not put a heavy object (of 10 kg or more) or an object that vibrates on the printer. If put a heavy object on the printer, please check the operation by yourself.

## Cautions on Handling



### WARNING

- Do not use the product in a location with volatile substances such as alcohol or paint thinner present, or near fire. Doing so may cause electric shock or fire.
- Shut down the product immediately if it produces smoke, a strange odor, or unusual noise. If you go on using the product, it may result in electric shock or fire. If an abnormality occurs, immediately turn off the power and remove the plug from the outlet, and then contact qualified service personnel for advice.
- Shut down the product immediately if a foreign object or water or other liquid gets inside the product. If you go on using the product, it may result in electric shock or fire. Immediately turn off the power and remove the plug from the outlet, and then contact qualified service personnel for advice.
- Do not disassemble the areas other than those mentioned in this manual.
- Never attempt to repair the product yourself as doing so is dangerous.
- Do not use the product in a location where inflammable gas, explosive gas, etc. is present in the atmosphere. Furthermore, do not use aerosol sprayers containing flammable gas inside or around the product. Doing so may cause fire.
- Do not connect cables in ways other than those mentioned in this manual. Doing so may cause fire. It may also damage the other connected devices.
- Do not touch the areas inside the product other than those mentioned in this manual. Doing so may cause electric shock or burns.
- Do not insert metal or flammable materials, or allow them to fall into the product. Doing so may cause electric shock or fire.
- If the screen of the printer is damaged, handle the liquid crystal inside it very carefully. Should any of the following situations arise, take emergency measures.
  - \* When any part gets onto your skin, wipe off the deposit, and wash the area properly with soap and water.
  - \* When any part gets into your eyes, flush them with clean water for at least 15 minutes, and thereafter, consult with a doctor.
  - \* When a part gets into your mouth, immediately consult with a doctor.



### CAUTION

- Do not allow anyone to stand or place heavy objects on top of the product. In particular, be careful in the case of a household with children. The product may fall or collapse, causing breakage and possible injury.
- Install the cables and optional products in the proper direction according to the proper procedures. If they are installed improperly, it may result in fire or injury. Follow the instructions in this manual to install them properly.
- Before moving the product, shut down and unplug the product, and make sure that all the cables are disconnected. Failure to do so may damage a cable, causing electric shock or fire.
- Do not subject the product to vibration or shock while the power is on. Doing so may cause printing malfunction.
- Do not store or transport the product while it is tilted, standing, or upside down. Doing so may cause the ink to leak.
- Store the cutter in a place out of reach of children. There is a risk of injury from the cutter blade. When replacing the cutter, handle it with care.

## Cautions on Power Supply



### WARNING

- Be sure to use the specified AC adapter (AC ADAPTER,K1 (Model: M248B)) only. In addition, do not use the specified adapter with another device. Otherwise electric shock or fire may occur.
- Observe the following points when handling the AC adapter. Otherwise electric shock or fire may occur.
  - \* Do not use in a location where rain or water will get on the AC adapter.
  - \* Do not suspend the product by the power cord.
  - \* Do not allow a clip or other metal object to touch the connectors.
  - \* Do not cover with bedding.
- Do not allow dust or other foreign material to adhere to the power plug. Doing so may cause electric shock or fire.
- Insert the power plug securely all the way into the outlet. Otherwise electric shock or fire may occur.
- Do not use a power cord other than that supplied with the product. In addition, do not use the supplied power cord with another device. Doing so may cause electric shock or fire.
- Do not use a damaged power cord. Doing so may cause electric shock or fire. Contact qualified service personnel for advice if the power cord is damaged. Furthermore, observe the following points so as not to damage the power cord.
  - \* Do not modify the power cord.
  - \* Do not place heavy objects on the power cord.
  - \* Do not forcibly bend, twist, or pull the power cord.
  - \* Do not lay the power cord near a heating appliance.
- Do not insert or remove the power plug with a wet hand. Doing so may cause electric shock.
- Do not connect many power cords to one outlet. Doing so may cause fire. Supply power directly from a power outlet.
- Regularly disconnect the power plug from the outlet and clean the base of the prongs and between the prongs. Leaving the power plug connected to the outlet for a long period of time may cause dust to accumulate on the base of the power plug prongs, resulting in a short and fire.
- Hold the plug and do not pull the cord when disconnecting the power plug from the outlet. Pulling the cord may damage the cord or deform the plug, causing electric shock or fire.
- Do not remove and insert the power plug from/to the outlet while the printer is powered on. Doing so may cause electric shock.





### CAUTION

To ensure safety, unplug the product before leaving it unused for an extended period.

## Cautions on Ink Cartridges



### CAUTION

- The ink cartridges that can be used differ depending on the model number of the product. Use ink cartridges suitable for the model number of your printer. ("[Ink Cartridges](#)" on page 361)
- Shake new ink cartridges well before installing them.
- Do not touch the IC chip on an ink cartridge. Doing so may result in normal operation and printing becoming no longer possible.
- The product uses ink cartridges equipped with IC chips to manage the amount of ink used and other information so ink cartridges are usable even if they are removed and reinstalled. However, if an ink cartridge with not much ink remaining is removed and reinstalled, it may not be usable. Some ink is consumed each time cartridges are installed because the product automatically checks their reliability.
- When replacing the black ink cartridge, make sure to replace with a cartridge of the same type of black ink. The printer does not work if you install a cartridge of different type of black ink.
- Install ink cartridges of all colors. Printing is not possible if even only one ink cartridge is missing.
- Since ink cartridges are designed to stop the operation before ink runs out completely to maintain the quality of the print head, some ink remains in the used ink cartridges.
- All the ink colors are consumed also for the maintenance operations when an ink cartridge is replaced and for print head cleaning.
- Do not turn off the power or open the ink cartridge cover during ink charging (while the  (power) LED lamp is flashing). Opening the cover may cause the ink to be recharged, resulting in more ink being consumed. Also, it may result in normal printing becoming no longer possible.
- Even for monochrome printing, all the ink colors are used in an operation designed to maintain the printing and print head quality.
- Do not disassemble an ink cartridge. Doing so may cause ink to get into eyes or onto skin.
- Do not disassemble or modify an ink cartridge. Doing so may cause printing malfunction.
- Use of old ink cartridges may result in reduced print quality. Use ink cartridges up within six months after opening the packages. The usage period for ink cartridges is printed on the packaging of the individual ink cartridges.
- If ink contacts your skin, eyes, or mouth, take the following actions.
  - \* When ink gets onto your skin, immediately wash the area with soap and water.
  - \* When ink gets into your eyes, immediately flush them with water. Leaving the ink as is may result in bloodshot eyes or mild inflammation. If something is wrong, immediately consult with a doctor.
  - \* When ink gets into your mouth, immediately spit it out and consult with a doctor.
- There may be some ink around the ink supply port on a removed ink cartridge. Take care so that it does not stain the desk or other surface.
- Do not open an ink cartridge package until you are ready to install the ink cartridge in the product.
- Do not shake an ink cartridge too hard. The ink cartridge may leak if you shake it around too much or push the sides strongly.
- Do not allow foreign objects to fall into the cartridge installation section. Doing so may result in normal printing becoming no longer possible. Remove any object that falls into the installation section, taking care not to damage the section.
- When ink is charged the first time (right after purchase), ink is consumed for filling the print head nozzles (ink discharge holes) to get ready for printing. Therefore, the number of the sheets that can be printed may be fewer than for cartridges installed later.
- When the printer is powered off with the  (power) button, the print head is automatically capped to prevent the ink from drying. When you will not use the printer after installing the ink cartridges, be sure to turn the power off with the  (power) button. Do not pull out the power plug or turn off the breaker while the power is on.





- Printing on water-repellent paper such as art paper, which is slow-drying, may cause print stains. Also, if you print on glossy paper, fingerprints may get on the paper or ink may adhere to your fingers when you touch the print surface. Select and use paper that will not cause print stains.
- Store the ink cartridges in a place out of reach of children.
- Epson recommends storing ink cartridges in a cool and dark place.
- If you wish to use ink cartridges that have been stored in a cold place for a long period of time, leave them for at least 3 hours in a place that is at room temperature before use.
- Do not remove the ink cartridges from the product when storing or transporting the product.

## Cautions on the Maintenance Box



- Store in a place out of reach of children. Do not drink any adhered ink.
- Do not disassemble or modify the maintenance box. Doing so may cause ink to get into eyes or onto skin.
- Do not touch the IC chip on the maintenance box.
- If a maintenance box that can still be used has been removed and left detached for a long period of time, do not reuse it.
- Do not peel off the film from the top surface of the maintenance box.
- If ink contacts your skin, eyes, or mouth, take the following actions.
  - \* When ink gets onto your skin, immediately wash the area with soap and water.
  - \* When ink gets into your eyes, immediately flush them with water. Leaving the ink as is may result in bloodshot eyes or mild inflammation. If something is wrong, immediately consult with a doctor.
  - \* When ink gets into your mouth, immediately spit it out and consult with a doctor.
- Do not shake a used maintenance box too hard. The ink may leak from the maintenance box if you swing or shake it too hard.
- Avoid storing the maintenance box under high temperatures or in a frozen state.
- Keep it away from direct sunlight.

## Caution Label

The labels affixed to the product indicate the following cautions.



- Do not touch the blade of the auto cutter with a hand. Doing so may cause injury.

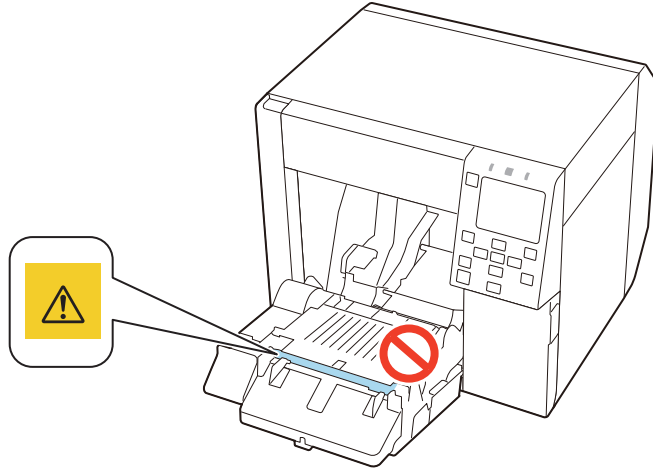

- Do not touch the movable blade of the auto cutter with a hand. Doing so may cause injury. As the label is affixed to the back of the auto cutter unit, it can be checked when the unit is removed.

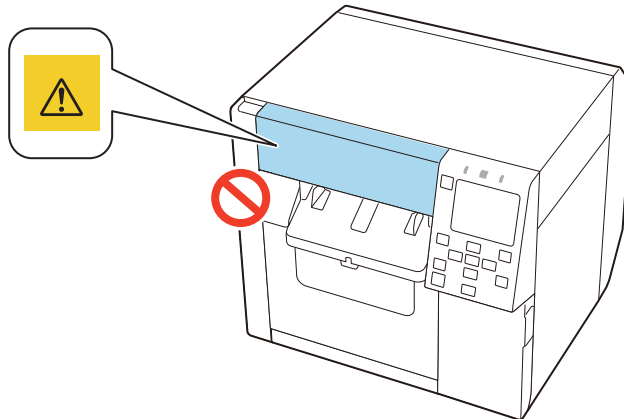

- To prevent fingers from being trapped, the lock mechanism is activated to stop the cover closing if the unit is raised up from the installation surface. When using the product, install it on a level surface.

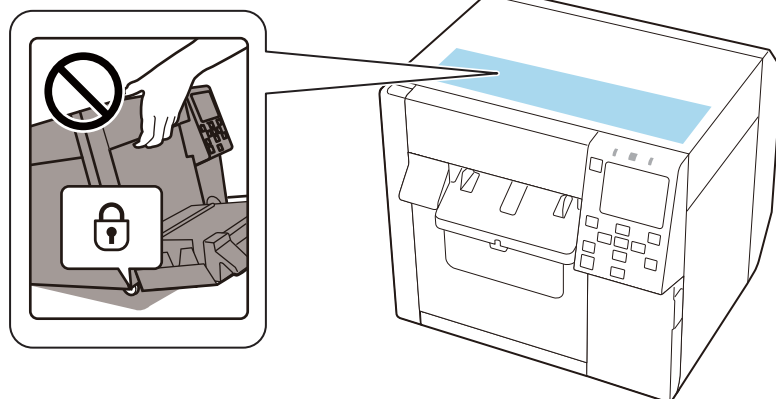

## Restriction of Use

When this product is used for applications requiring high reliability/safety such as transportation devices related to aviation, rail, marine, automotive etc.; medical equipment; disaster prevention devices; various safety devices etc.; or functional/precision devices etc., you should use this product only after giving consideration to including fail safes and redundancies into your design to maintain safety and total system reliability. This product is not intended for use in applications requiring an extremely high level of reliability and safety, such as in aerospace instruments, main communication equipment, nuclear power control equipment, etc. Please make your own judgment on this product's suitability after a full evaluation.

## About This Manual

### Aim of the Manual

This manual is intended to provide information required for developing, designing, and installing a system, and for developing and designing printer applications for developers.

### Manual Content

This manual consists of the following chapters.

- Chapter 1     [Product Overview](#)
- Chapter 2     [Setup](#)
- Chapter 3     [Handling](#)
- Chapter 4     [Information for Application Development](#)
- Appendix     [Appendix](#)

### Screenshots

Unless otherwise noted, Windows 10 screenshots are used in this manual. Depending on the printer model and OS version that you use, the screenshots may differ from actual Windows screens.

Depending on version of the printer driver and utility you are using, screens shown in this manual may slightly differ from actual screens.

# Contents

■ <b>Before Use</b> .....	<b>3</b>
Manuals for This Product.....	3
Symbols Used in This Guide.....	4
Safety Precautions.....	5
Cautions on Installation.....	5
Cautions on Handling.....	6
Cautions on Power Supply.....	7
Cautions on Ink Cartridges.....	8
Cautions on the Maintenance Box.....	9
Caution Label.....	10
■ <b>Restriction of Use</b> .....	<b>11</b>
■ <b>About This Manual</b> .....	<b>11</b>
Aim of the Manual.....	11
Manual Content.....	11
Screenshots.....	11
■ <b>Contents</b> .....	<b>12</b>

---

## ***Product Overview***..... **17**

■ <b>About Models of this Product</b> .....	<b>17</b>
Gloss Black Ink/Matte Black Ink.....	17
Product Firmware and Driver Versions.....	17
■ <b>Part Names and Functions</b> .....	<b>18</b>
Front.....	18
Inside.....	19
Rear.....	20
Connectors.....	21
Operation Panel.....	23
■ <b>Auto Nozzle Check System</b> .....	<b>26</b>
Auto Nozzle Check Settings.....	26
Complementing Missing Dots due to Clogged Nozzles (Nozzle Verification Technology).....	29
■ <b>Periodic Auto Cleaning</b> .....	<b>30</b>
Setting Time to Start the Periodic Auto Cleaning.....	30
Execution of the Periodic Auto Cleaning.....	30
Examples of the Time Setting to Avoid Interrupting Printing Operation.....	31
■ <b>Checking the Printer Status</b> .....	<b>32</b>
Checking the Paper Information.....	32
Checking the Status of Consumables.....	33
Printing Nozzle Check Patterns.....	33
Printing Status Sheet.....	34
Checking Network Connection and Settings.....	36

<b>Setup .....</b>	<b>38</b>
■ <b>Unpacking .....</b>	<b>38</b>
■ <b>Removing the Protective Materials .....</b>	<b>39</b>
■ <b>Installing the Printer .....</b>	<b>40</b>
■ <b>Connecting the Power Cable .....</b>	<b>41</b>
■ <b>Turning On/Off .....</b>	<b>42</b>
Turning the Power On .....	42
Turning the Power Off .....	42
■ <b>Setting Language and Date/Time .....</b>	<b>43</b>
■ <b>Selecting Black Ink Type .....</b>	<b>43</b>
■ <b>Installing the Ink Cartridges .....</b>	<b>44</b>
Replacing the Ink Cartridges .....	45
Replacing the Maintenance Box .....	48
■ <b>Installing the Printer Driver and Connecting to a Computer .....</b>	<b>51</b>
Setup using Install Navi .....	51
Setup without using Install Navi .....	52
■ <b>Media Settings .....</b>	<b>65</b>
■ <b>Loading Paper .....</b>	<b>66</b>
Loading Roll Paper .....	67
Loading Fanfold Paper .....	73
Adjusting the Shutters .....	78
How to Remove Paper .....	80
■ <b>Test Print .....</b>	<b>82</b>
Self-Test Printing .....	83
<b>Handling .....</b>	<b>84</b>
■ <b>Printer Driver for Windows .....</b>	<b>84</b>
Printer Driver .....	84
Printer Driver Screen Configuration .....	85
Media Settings .....	86
Paper Source and Paper Detection Settings .....	91
User-Defined Paper .....	93
Banner Printing .....	98
Printing Barcodes .....	100
Printing 2D Symbols .....	111
Printing Barcodes / 2D Symbols on .NET Environment .....	119
Favorite Settings .....	121
User Defined Information .....	124
Exporting/Importing Printer Driver Settings .....	124
Starting PrinterSetting from the Printer Driver .....	129
Speeding Up Printing using High Speed Batch Label Printing Function .....	130
Sharing the Printer Driver .....	137

Setting EPSON Status Monitor 3.....	161
Restrictions on Using the Printer Driver.....	167
Isolating the Printer Driver.....	168
<b>■ Printer Driver for Mac .....</b>	<b>170</b>
Basic Procedure for Printing.....	170
Customizing the Printer Driver.....	176
Epson Label Printer Utility.....	178
<b>■ Printer Driver for Linux .....</b>	<b>180</b>
Getting the Package (epson-inkjet-printer-cw-c4000).....	181
Installing the Printer Driver .....	181
Installing Input/Output Modules .....	181
Adding the Printer to the CUPS .....	181
Installing Epson Label Printer Utility for Linux .....	183
Starting Epson Label Printer Utility for Linux.....	183
Exiting Epson Label Printer Utility for Linux.....	184
Uninstalling Printer Driver, Epson Label Printer Utility for Linux.....	184
<b>■ Printing from SAP System .....</b>	<b>186</b>
Methods of Printing from SAP System .....	186
Indirect Printing.....	188
High Volume Printing .....	188
<b>■ PrinterSetting (Windows).....</b>	<b>189</b>
How to Start PrinterSetting .....	190
How to Apply Settings .....	191
Media settings.....	192
Layout settings.....	193
Position adjustment.....	195
Print results adjustment.....	197
Store data in the printer.....	198
Background image settings .....	202
Print head maintenance .....	206
Printer settings.....	207
Print Head Alignment.....	208
Panel settings .....	214
Operating Time Settings.....	215
Nozzle check settings .....	216
Advanced settings .....	217
Initialize printer.....	225
Printer information .....	226
Settings save and restore .....	228
Option .....	229
<b>■ Operation Panel Settings.....</b>	<b>230</b>
<b>■ WebConfig.....</b>	<b>242</b>
<b>■ Epson Device Admin.....</b>	<b>244</b>
<b>■ Software NiceLabel Cloud .....</b>	<b>245</b>
Registering a Printer (WebConfig) .....	245
Registering a Printer (Epson Device Admin) .....	251

■ <b>Spot Color Settings</b> .....	257
Creating Spot Color Setting File.....	257
Printing using the Spot Color Setting File.....	262
■ <b>Color Correction</b> .....	263
Relationship Between Driver Settings, Color Correction Methods, and Spot Color Settings.....	263
Setting on the Printer .....	265
Setting using OS.....	267
No composite .....	277
■ <b>Processing Paper to Avoid Unprinted Labels</b> .....	278
Printing from the 1st Label .....	278
Printing on the Last Label .....	280
■ <b>Adjusting Sensitivity of the Detectors and Threshold for Detecting Labels</b> .....	282
■ <b>Detecting Differences in Paper Size Using Label Command</b> .....	282
■ <b>Restricting Operation of the Operation Panel (Lock Setting function)</b> .....	283
Checking the Initial Value for the Administrator Password .....	283
Enabling the [Lock Setting] Function .....	284
Changing the Administrator Password .....	284
Resetting the Administrator Password.....	285
■ <b>Cleaning the Printer</b> .....	286
Cleaning the Exterior .....	286
Cleaning the Platen .....	287
Cleaning the Auto Cutter .....	289
Cleaning the Inside of the Printer (when Paper is fed from the Inside).....	290
Cleaning the Inside of the Printer (when Paper is fed from the Outside) .....	291
Cleaning the Print Head.....	292
■ <b>Storing the Printer After Ink is Charged</b> .....	296
Storing the Printer for Long Periods.....	296
Transporting or Storing the Printer at -10°C (With Matte Black Ink Installed) .....	297
For Using the Printer after Long Storage.....	297
■ <b>For Transporting the Printer</b> .....	298
■ <b>Troubleshooting</b> .....	299
A message is displayed on the operation panel. ....	299
Print Quality Problems .....	303
Cannot Print .....	306
Network Connection Check Errors.....	307
Unable to Connect to the Network .....	310
A message is displayed on the computer screen .....	311
Printing from a computer is impossible or becomes suddenly impossible.....	312
Print Job is Canceled on PC but "Printing" Message on Printer Does Not Disappear.....	314
Error Beep Sound Does Not Stop .....	314
Paper Jam.....	315
<hr/>	
<b><i>Information for Application Development</i></b> .....	<b>319</b>
■ <b>How to Control the Printer</b> .....	<b>319</b>

■ Using the Epson Inkjet Label Printer SDK .....	320
Operating Environment.....	320
How to Get Software.....	320
■ Using the iOS SDK/Android SDK/Web Application SDK .....	321
How to Get.....	321
■ Using the ESC/Label Commands.....	321
■ Replacing from ZPL II Compatible Monochrome Printer .....	322
Changing from Two-Step Printing to One-Step Printing.....	322
Utilizing Templates .....	339
■ Software and Manuals .....	340

---

**Appendix..... 342**

■ Product Specifications .....	342
Operating Environment.....	343
Paper Specifications .....	344
Paper detection method .....	357
Electrical Specifications .....	357
Reliability.....	358
Environmental Specifications.....	359
Overall Dimensions .....	360
■ Consumables Specifications .....	361
Ink Cartridges .....	361
Maintenance Box.....	361
■ Optional Products.....	362
OT-PT40.....	362
OT-CU40.....	364
■ Downloading Printer Driver, Utilities, and Manuals.....	365
■ Label Print Applications.....	365
How to Get Software.....	365
■ For Inquiries .....	366



# Product Overview

This chapter describes features of the product.

## About Models of this Product

### Gloss Black Ink/Matte Black Ink

You can select either gloss black (BK) or matte black (MK) for the type of black ink you want to use. The printer prompts you to select it when you turn on the printer for the first time.



#### IMPORTANT

You cannot change the black ink type once you select the black ink type and let the printer charge the ink.

### Product Firmware and Software Versions

Use the product with a combination of latest versions of the product firmware, printer driver, and utility. You can check the version of your printer firmware by using one of the following methods.

- Printing the status sheet ("[Printing Status Sheet](#)" on page 34)
- Checking on the operation panel ("[Operation Panel Settings](#)" on page 230)

To get the latest version of the printer driver and utility, see "[Downloading Printer Driver, Utilities, and Manuals](#)" on page 365.

Some Epson software is available in different versions depending on the firmware version of the printer. Check the table below and use the printer and the software in the "Available" combination.

If you use them in the "Not available" combination, they may not work properly, or some functions may not be available.

Printer firmware version	Software Version	
	EpsonNet Config SE Ver.1.4.0 or earlier Epson Device Admin Ver.4.20.1 or earlier	EpsonNet Config SE Ver.1.7.0 or later Epson Device Admin Ver.4.20.2 or later
TG31N8, TG06N7 TG19N5, TG31N3 TG09N2, TG08MB TG26M5, TG10M2	Available	Available
Versions higher than those listed above	Not available	Available

## Part Names and Functions

This section describes the main operation parts.

### Front

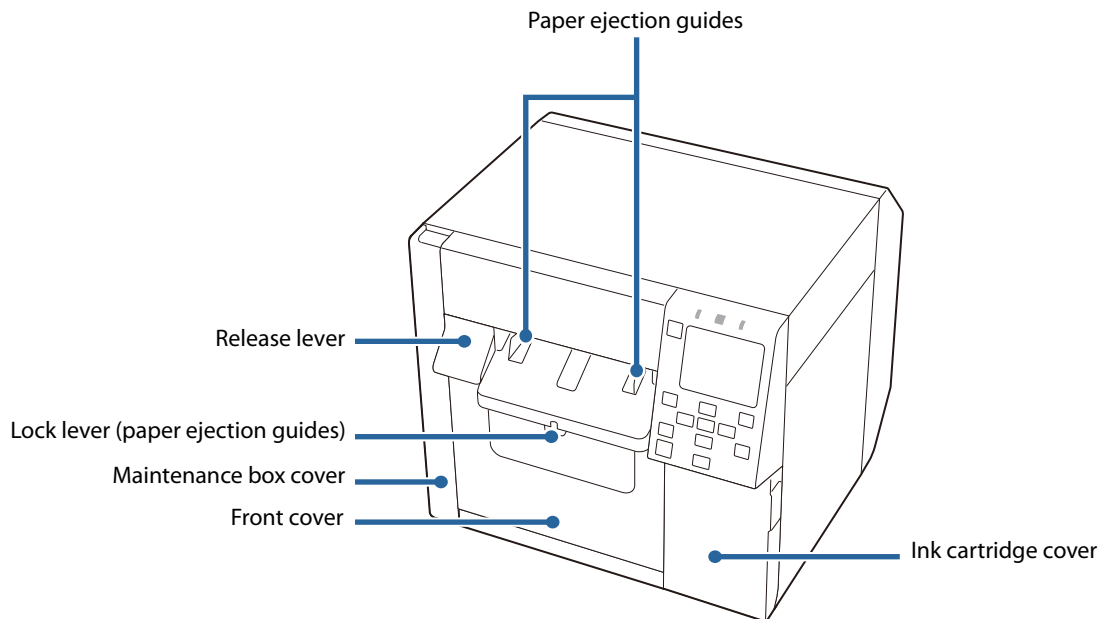

Name	Description
Release lever	Pull this lever towards you to open the front cover.
Lock lever (paper ejection guides)	Press down this lever to enable adjustment of the paper ejection guides. Pull up this lever until it clicks into place to lock the paper ejection guides.
Maintenance box cover	Open this cover to install/replace the maintenance box. ( <a href="#">"Replacing the Maintenance Box" on page 48</a> )
Front cover	Open this cover to load or replace paper.
Ink cartridge cover	Open this cover to install/replace the ink cartridge. ( <a href="#">"Replacing the Ink Cartridges" on page 45</a> )
Paper ejection guides	These guides are for preventing the paper from getting out of position when ejected. Adjust them to match the paper width.

## Inside

Roll paper guides    Lock lever (roll paper guides)

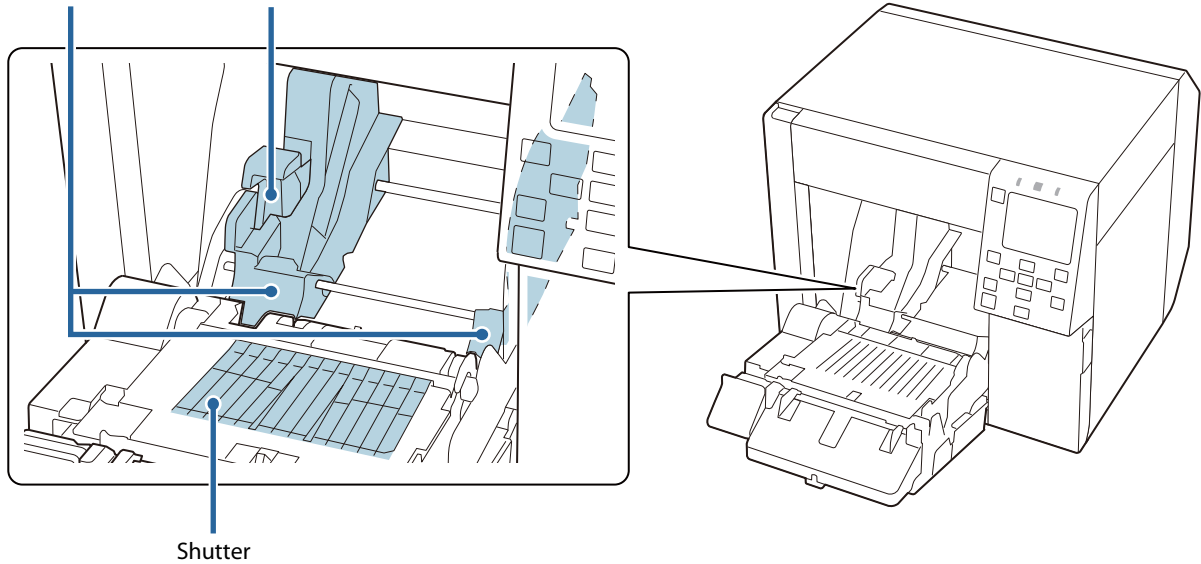

Name	Description
Lock lever (roll paper guides)	Pull up this lever to enable adjustment of the roll paper guides. Push down this lever to lock the roll paper guides.
Roll paper guides	These guides are for fixing the roll paper in place. Adjust them to match the paper width.
Shutter	Adjust this to match the paper width. ("Adjusting the Shutters" on page 78)

## Rear

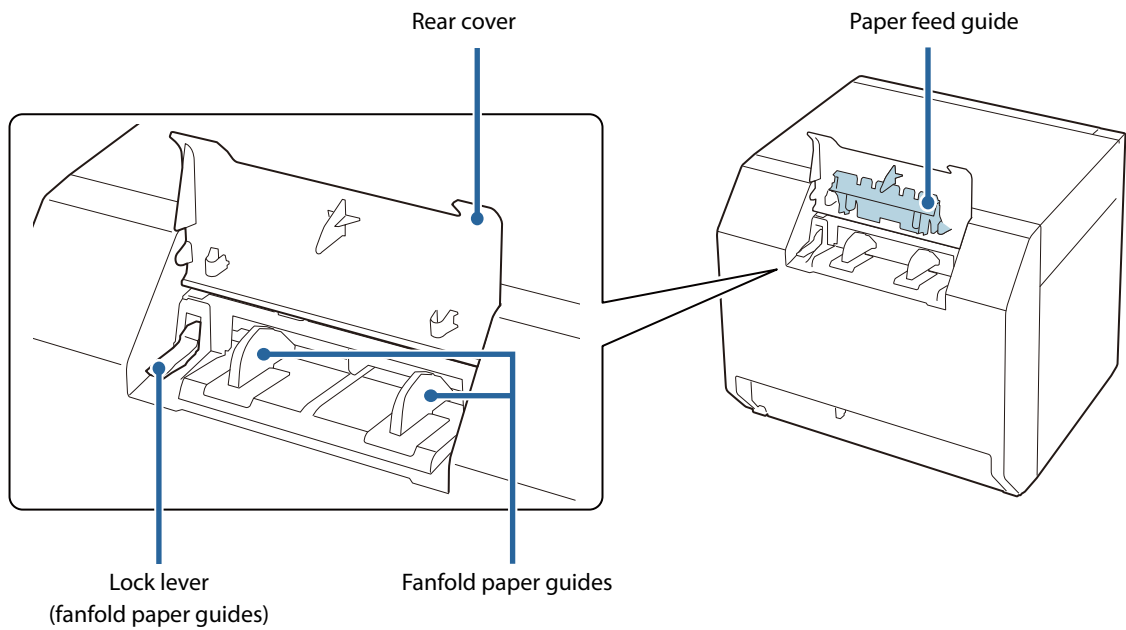

Name	Description
Lock lever (fanfold paper guides)	Pull up this lever to enable adjustment of the fanfold paper guides. Pull down this lever to lock the fanfold paper guides.
Fanfold paper guides	These guides are for preventing the paper from getting out of position when fed into the printer. Adjust them to match the paper width.
Paper feed guide	Attach this guide inside the front cover when using fanfold paper.
Rear cover	Open this cover to load or replace the fanfold paper. ( <a href="#">"Loading Fanfold Paper" on page 73</a> )

# Connectors

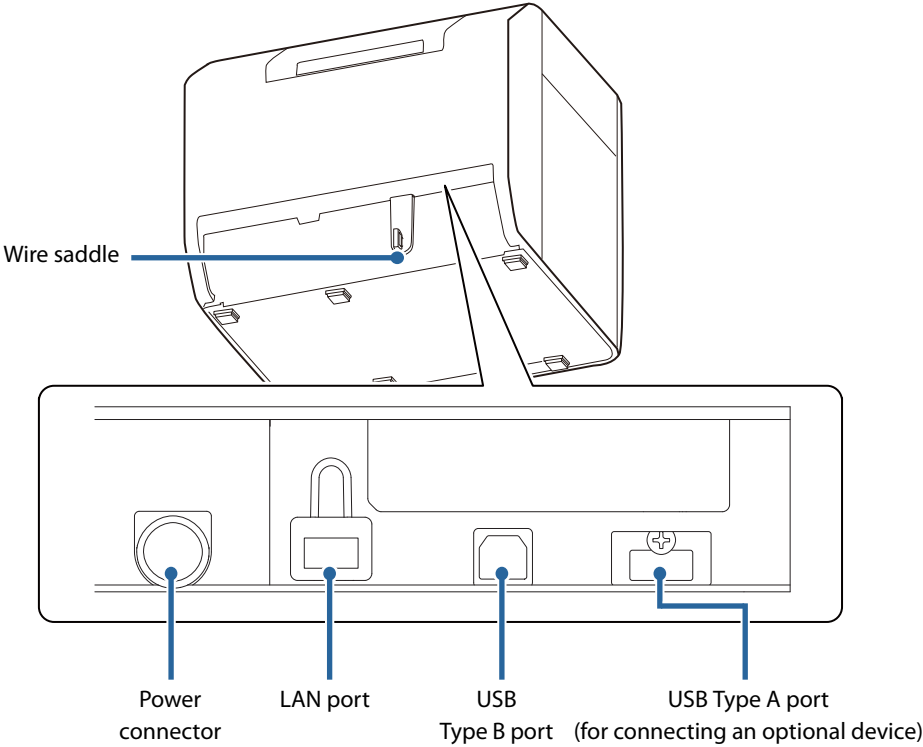



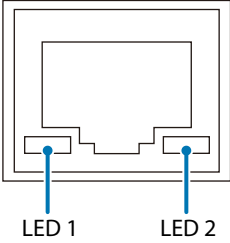

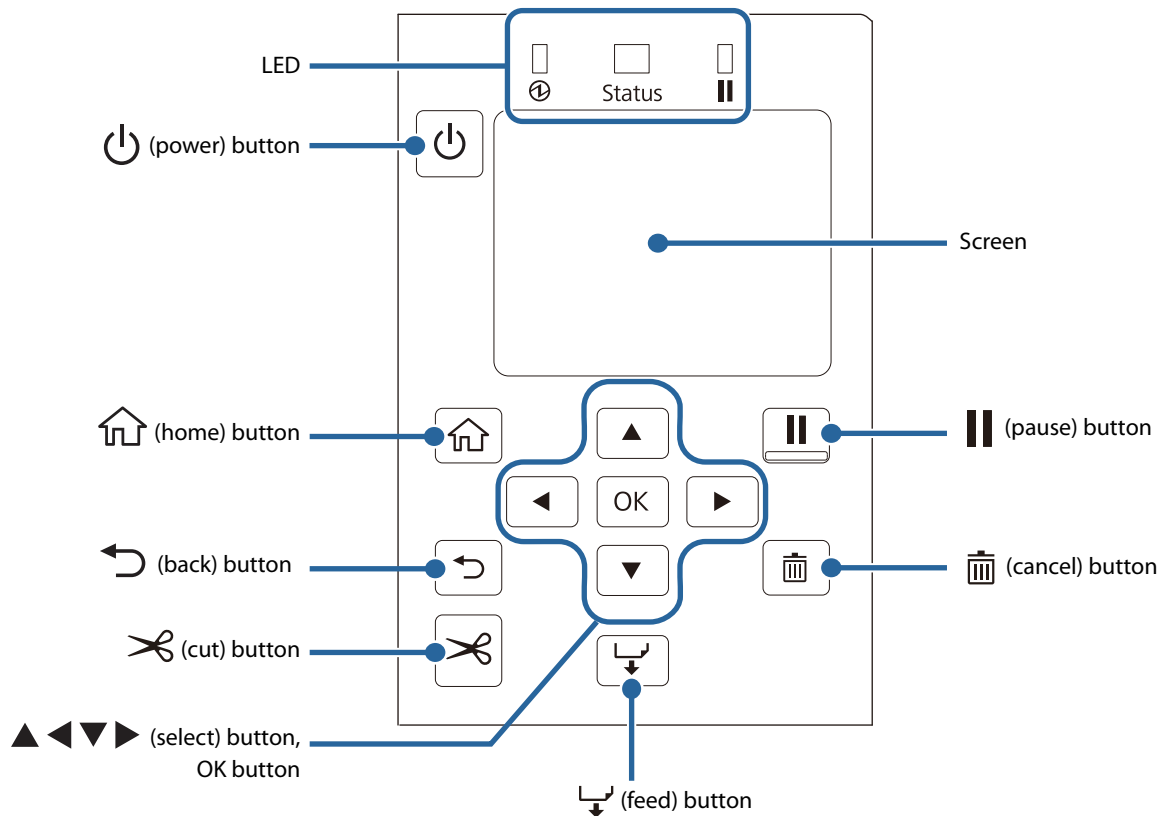

Name	Description
Wire saddle	Pass the USB cable through this saddle to prevent disconnection of the cable.
Power connector	Connect the power cable.

Name	Description																	
LAN port	<p>Connect a LAN cable.</p> <p><b>LED Status Indication</b></p>  <table border="1" data-bbox="485 654 1437 1048"> <thead> <tr> <th>LED</th> <th>LED status</th> <th>Description</th> </tr> </thead> <tbody> <tr> <td rowspan="3">LED1</td> <td>Lit yellow</td> <td>Connecting at one of the speeds</td> </tr> <tr> <td>Blinking yellow</td> <td>Sending/receiving data</td> </tr> <tr> <td>Off</td> <td>Not connected</td> </tr> <tr> <td rowspan="3">LED2</td> <td>Lit green</td> <td>Connecting using 1000BASE-T</td> </tr> <tr> <td>Lit orange</td> <td>Connecting using 100BASE-TX</td> </tr> <tr> <td>Off</td> <td>Connecting using 10BASE-T, or not connected</td> </tr> </tbody> </table>	LED	LED status	Description	LED1	Lit yellow	Connecting at one of the speeds	Blinking yellow	Sending/receiving data	Off	Not connected	LED2	Lit green	Connecting using 1000BASE-T	Lit orange	Connecting using 100BASE-TX	Off	Connecting using 10BASE-T, or not connected
LED	LED status	Description																
LED1	Lit yellow	Connecting at one of the speeds																
	Blinking yellow	Sending/receiving data																
	Off	Not connected																
LED2	Lit green	Connecting using 1000BASE-T																
	Lit orange	Connecting using 100BASE-TX																
	Off	Connecting using 10BASE-T, or not connected																
USB Type B port	Connect a USB Type B cable.																	
USB Type A port (for connecting an optional device)	<p>Connect the optional Wireless LAN Unit (OT-WL06).</p> <p>In some countries and regions, the wireless LAN unit option is not sold. Please contact qualified service personnel for details.</p>																	

## Operation Panel



Name	Description
LED	<p>The status of the printer can be checked from the flashing of the LEDs.</p> <ul style="list-style-type: none"> <li>⏻ (power) LED Stays on while the printer is on. Flashes during printing or charging ink.</li> <li>Status LED Stays on or flashes while an error or problem is occurring.</li> <li>⏸ (Pause) LED Stays on or flashes while the printer is paused.</li> </ul>
⏻ (power) button	Turns on/off the printer.
🏠 (home) button	Displays the Home screen.
↶ (back) button	Use to return to the previous screen.
✂ (cut) button	Use to cut paper.
▲◀▶▼ (select) button, OK button	Use the ▲◀▶▼ keys to select a menu item, and then press the OK button to activate the selected menu or setting.
📄 (feed) button	Press this briefly to feed paper by one page. Hold down to feed paper continuously.
🗑 (cancel) button	Cancels printing. Press the 🗑 (cancel) button while the printer is paused, and select [Next label format] or [All label formats] on the [Cancel Selection] screen to cancel printing.

Name	Description
 (pause) button	<ul style="list-style-type: none"> <li>If pressed while printing is in progress When the printer finishes printing the page being printed, it pauses and the  (pause) LED lights up. Press again to resume printing and the  (pause) LED will turn off.</li> <li>If pressed while the printer is ready to print The printer goes into a pause state and the  (pause) LED lights up. Press again to return the printer to the standby state and the  (pause) LED will turn off.</li> <li>If pressed while the printer is paused due to an error The printer is released from pause and the  (pause) LED turns off.</li> </ul>
Screen	Status of the printer, menus, and error messages are displayed.

## Home Screen

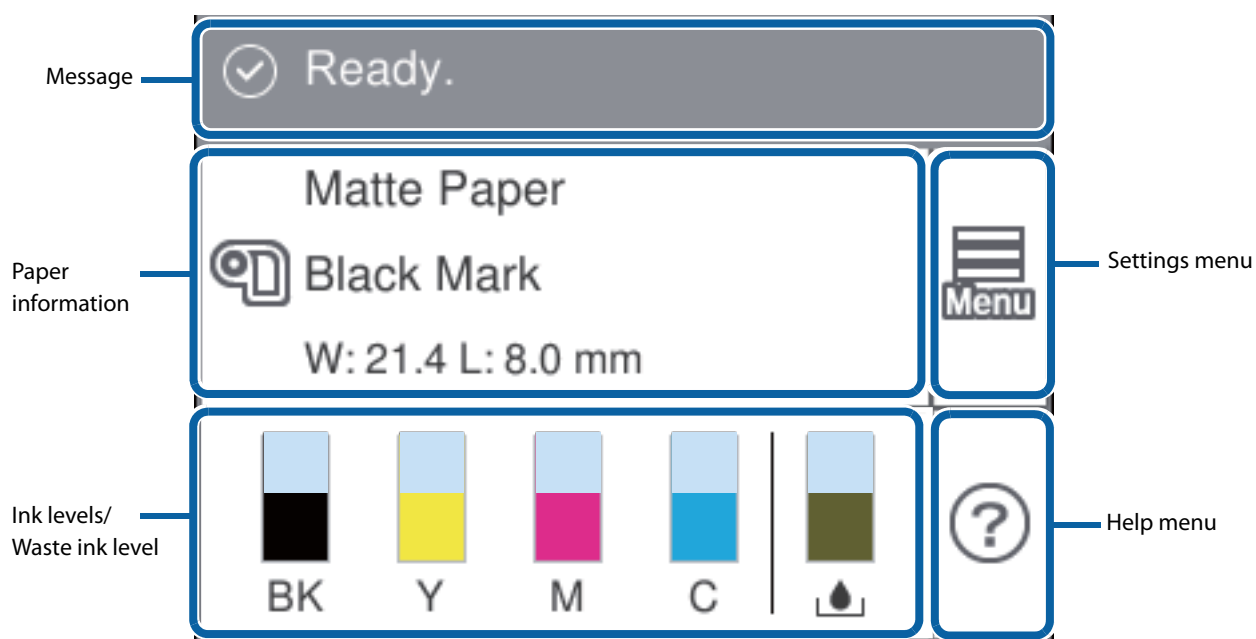

Name	Description
Message	A printer status or an error message is displayed. ( <a href="#">"A message is displayed on the operation panel."</a> on page 299)
Paper information	The current paper settings are displayed. Select this area to directly access the [Paper Settings] menus.
Ink levels/Waste ink level	The length of the bars indicate how much ink of each color is remaining, and how much space in the maintenance box is remaining. The shorter the bars are, the lower the ink levels and remaining space are. A [!] mark will appear when the ink cartridge or the maintenance box needs to be replaced soon. A [x] mark will appear when the ink cartridge or the maintenance box needs to be replaced. Matte black ink is displayed as "MK".



Name	Description
Help menu button	You can see troubleshooting information and basic operating procedures.
Settings button	Allows you to access the maintenance menus, various printer settings, and network settings. Throughout this manual, this button is indicated as [Menu]. All the settings available from this button are listed in the link below. <a href="#">("Operation Panel Settings" on page 230)</a>

## Auto Nozzle Check System

This printer is equipped with the automatic nozzle check function.

Depending on required print quality, you can change the following settings.

- Switch On or Off the nozzle check function
- How often to run the nozzle check
- Threshold for the nozzle check
- Whether to run a cleaning after the check

In addition to the above settings, if nozzle clogging is not cleared by the cleaning, the printer carries out supplemental printing using nozzles adjacent to the clogged nozzles.

By using these functions, you can prevent sharp decline in the print quality and barcode quality.

### Auto Nozzle Check Settings

The auto nozzle check is run at the following times.

- When the printer is turned on
- When the front cover is closed after a paper jam
- Just before running a regularly scheduled cleaning  
(["Periodic Auto Cleaning" on page 30](#))

If "Nozzle check settings" is set to "On", auto nozzle check is run at the time of the following cases.

- When the number of printouts has reached the number specified as the interval of the nozzle check.

If "Cleaning After Nozzle Check" has been set to "On", and the result of nozzle check exceeds the specified threshold, a head cleaning is run automatically to clear the nozzle clogging. After the cleaning, the nozzle check is run again. If the result of the check still exceeds the threshold, auto cleaning is also run again.



#### IMPORTANT

- This function does not completely prevent nozzle clogging. The printer cannot perfectly detect missing dots and skewed ink drops on printouts.
- To prevent misreading of characters that are partially missing due to nozzle clogging, it is recommended to use the printer with its default nozzle check settings. For information about the default settings, see [Maintenance] - [Nozzle check settings] in ["Operation Panel Settings" on page 230](#).
- If extremely high reliability is required for printouts, it is recommended to use fonts whose height is 3-dots or more.



- The cleaning cleans the entire print head. It does not clean the print head partially for cleaning only the clogged nozzles.
- A small amount of ink is consumed for the auto nozzle check system.
- The print head cleaning is run automatically after the nozzle check when set to do so. Ink is consumed for the head cleaning.

---

## Nozzle Check Settings (Auto nozzle check during printing)

You can turn on or off the auto nozzle check during printing.

The factory default is “On”.

### How to Set

Set using the operation panel of the printer, or using PrinterSetting.

See ["Operation Panel Settings" on page 230](#) or ["PrinterSetting \(Windows\)" on page 189](#).

---

## Nozzle Check Interval (Setting interval between checks)

Specify the number of printouts to let the printer run the nozzle check when reached the number. The printer will stop while running the check.

### How to Set

Set using the operation panel of the printer, or using PrinterSetting.

You can set the number of printouts in the range of 1 to 9999 in units of one sheet.

See ["Operation Panel Settings" on page 230](#) or ["PrinterSetting \(Windows\)" on page 189](#).



- The count of printouts is reset when the specified number is reached and nozzle check is performed, or when the printer is turned off.
- The factory default is “100”.

---

## Operation At Clogged Nozzle

You can set the action to be taken after the number of detected clogged nozzles exceeds the set "Threshold of Clogged Nozzles".

### How to Set

Set using the operation panel of the printer, or using PrinterSetting.

- Notify

After performing the operation set by [Cleaning After Nozzle Check], the printer stops and enters in standby mode (pause). Press the pause button to resume printing.

Continue Printing

After performing the operation set by [Cleaning After Nozzle Check], the printer continues printing without stopping.

See ["Operation Panel Settings" on page 230](#) or ["PrinterSetting \(Windows\)" on page 189](#).

---

## Setting Threshold of Clogged Nozzles

Specify the threshold of clogged nozzles used when running the auto nozzle check system. If the number of clogged nozzles exceed the threshold, a message is displayed on the printer’s screen, and the printer performs the operation set by [Cleaning After Nozzle Check]. If the number of clogged nozzles is below the threshold, you can use the supplemental printing function.

### How to Set

Set using the operation panel of the printer, or using PrinterSetting.

Specify the number in the range of 0 to 16 nozzles.

See ["Operation Panel Settings" on page 230](#) or ["PrinterSetting \(Windows\)" on page 189](#).



- The number of nozzles is the total of four color (BK (MK), C, M, Y) nozzles.
- The factory default is "2".

---

## Setting Cleaning After Nozzle Check

You can set to run an auto head cleaning when the number of detected clogged nozzles exceeds the threshold.

### How to Set

Set using the operation panel of the printer, or using PrinterSetting.

- On  
When the number of clogged nozzles exceeds the threshold, a message is displayed on the printer's screen and the cleaning is run automatically.
- Off  
When the number of clogged nozzles exceeds the threshold, a message is displayed on the printer's screen, but the cleaning is not run.

The factory default is "On".

See ["Operation Panel Settings" on page 230](#) or ["PrinterSetting \(Windows\)" on page 189](#).

---

## Clearing All Nozzle Check Settings

You can restore the nozzle check settings to the state at the time of purchase (default value).

### How to Set

Set using the operation panel of the printer, or using PrinterSetting.

See ["Operation Panel Settings" on page 230](#) or ["PrinterSetting \(Windows\)" on page 189](#).

## Complementing Missing Dots due to Clogged Nozzles (Nozzle Verification Technology)

The “Nozzle Verification Technology” function automatically complements missing dots caused by clogged nozzles with dots generated by nozzles adjacent to the clogged nozzles. The number of nozzles that can be complemented is up to 16 nozzles. However, if the clogged nozzles are located next to each other, the complement function does not work well. If the number of clogged nozzles exceeds 16, complementing 16 nozzles is performed without stopping the printing operation.

You cannot use this function if you have disabled the auto nozzle check function. Enable the “Nozzle check settings” to use this function.



- This function cannot perfectly complement missing dots, so drop in print quality or barcode quality can occur even if this function is used.
- Since the complement is performed according to information of clogged nozzles that has been acquired when starting printing, nozzles that get clogged during printing are not complemented.

### How to Set

Set using the operation panel of the printer, or using PrinterSetting.

The factory default is “Enable”.

See ["Operation Panel Settings" on page 230](#) or ["PrinterSetting \(Windows\)" on page 189](#).

## Periodic Auto Cleaning

To maintain the print head in good condition, the printer may run a cleaning automatically. The cleaning takes 3 to 14 minutes, and printing is disabled during the cleaning. To prevent the cleaning from running when you want to print, set the time to start the periodic auto cleaning.

The cleaning will start at the specified time. However, the cleaning is not run if the printer determines that the print head does not need to be cleaned.

Setting the cleaning start time allows you to clean the print head without interrupting printing operation. The default time is "0:00".

### Setting Time to Start the Periodic Auto Cleaning

Set using the operation panel of the printer, or using PrinterSetting.

During the cleaning, printing is disabled. Specify a time when the printer is on but not in use. The time can be set in one-minute increments.

For the setting procedure, see "[Operation Panel Settings](#)" on page 230 or "[PrinterSetting \(Windows\)](#)" on page 189.



- The cleaning takes 3 to 14 minutes.
- If you set a time within less than 10 minutes from the current time, the cleaning is run at the set time 24 hours later.

### Execution of the Periodic Auto Cleaning

At the set time, the cleaning is automatically run if the printer is on and it determines that the cleaning is necessary.



- If the printer has been left unused without being powered on for a long time, the cleaning may be run when the printer is turned on.
- In the following cases, the cleaning is not run at the set time. It is run next time the printer is turned on.
  - The printer is not powered on.
  - The ink level is too low to run the cleaning, or some ink cartridge(s) needs to be replaced.
  - The remaining amount of space in the maintenance box is too low to run the cleaning, or the box needs to be replaced.

## Examples of the Time Setting to Avoid Interrupting Printing Operation

The followings are examples of the cleaning start time setting to reduce the likelihood of unintended cleaning during printing.

### **In the case that the printer is always powered on**

Set the time to a time that printing work is not performed, such as midnight.

### **In the case that the printer is powered on and off every day**

- Set the time to a time that the printer is off, such as midnight, to let the printer run the cleaning right after it is powered on.
- If printing work is not performed during lunch break, set the time to a time such as 12:00 in order to let the printer run the cleaning during the lunch break.

## Checking the Printer Status

The status of the printer can be checked from the lighting/flashing of the LEDs, and from the printer screen. Also, by printing the status sheet, you can check the printer settings and condition of the nozzles.

["Printing Status Sheet" on page 34](#)

### Checking the Paper Information

Information of currently loaded paper; paper type and paper source setting is displayed on the home screen.

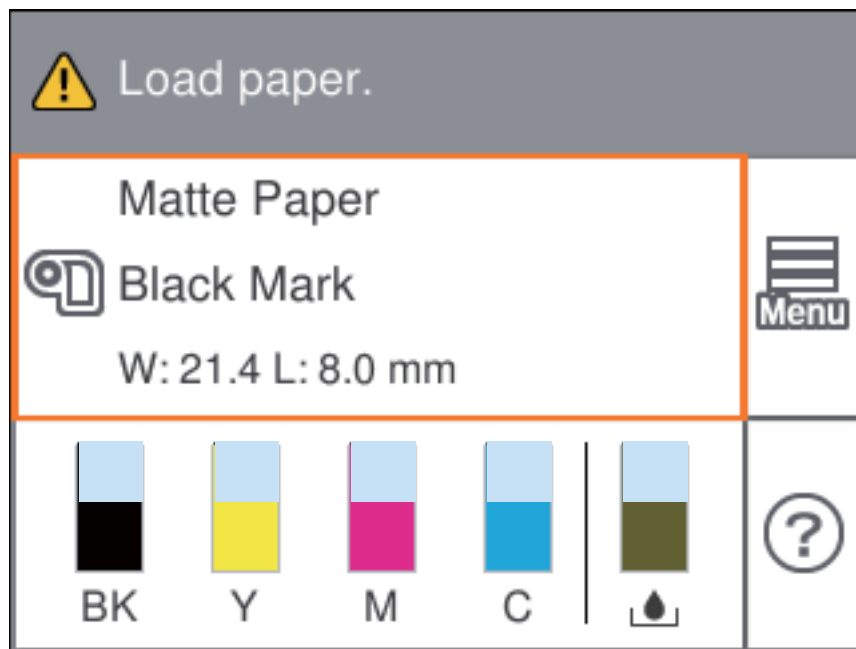

Select this area to directly access the [Paper Settings] menus.  
You can also make the paper settings using the printer driver.

["Paper Source and Paper Detection Settings" on page 91](#)

If the settings differ between the operation panel and the printer driver, the settings of the printer driver are applied.



## Checking the Status of Consumables

On the home screen of the printer, you can check the following information; the status of the ink cartridges and the maintenance box, paper settings (paper type, detection method, width, length). ("[Home Screen](#)" on page 24)

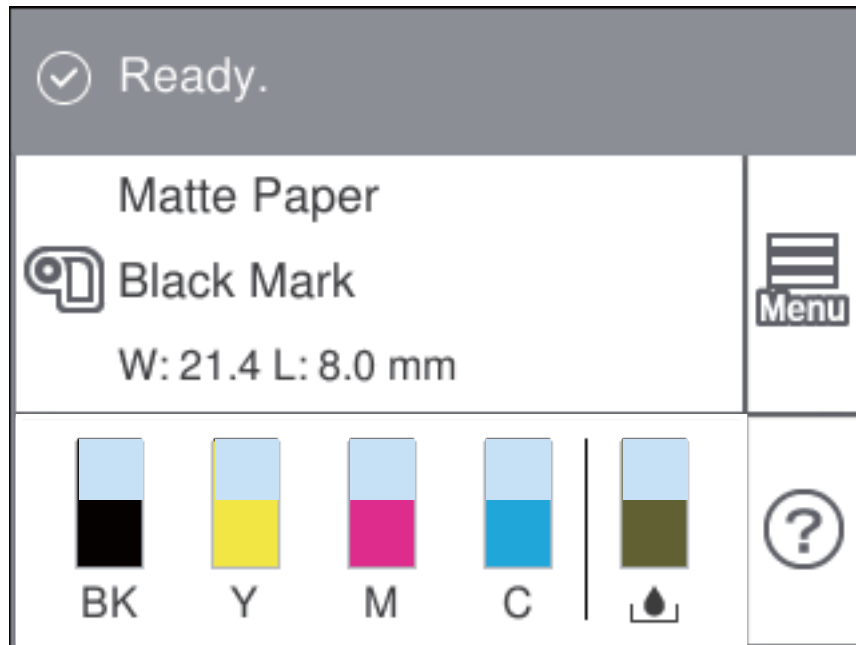

## Printing Nozzle Check Patterns

By printing the nozzle check patterns, you can check the print head nozzles for clogging. To print the check patterns, select the menu as described below.

### Using the Operation Panel

[Menu] - [Maintenance] - [Print Head Nozzle Check]

### Using the Printer Driver

Click [Nozzle Check] on the [Printer Utilities] window.

### Using the WebConfig

Select [Print Nozzle Check Pattern] on the [Maintenance] window, and then click [Start].

## Printing Status Sheet

By printing the status sheet, you can check the firmware version and the current printer settings, such as print mode and media detection settings.

On the operation panel, select the menu in the order shown below to print the report.

[Menu] - [General Settings] - [Network Settings] - [Network Status] - [Print Status Sheet]



### IMPORTANT

- When printing the status sheet, load paper that is 101.6 mm (4.00 inches) wide or larger.
- When printing the status sheet (Network settings), load paper that is 96.6 mm (3.80 inches) wide or more and 84.7 mm (3.33 inches) long or more.

## Amount of Remaining Paper Required to Print a Status Sheet

### Continuous paper / continuous label

If the paper width is 101.6 mm (4.00 inches) or more: 415.5 mm (16.36 inches)



Printing a status sheet with black mark detection still enabled may increase the amount of remaining paper required. We recommend using settings where black marks are not detected, even for paper with black marks, when printing.

### Die-cut label (included roll paper)

For the included roll paper, the status sheet can be printed with three labels.

Included roll paper: paper width 108.0 mm (4.25 inches), paper length 174.8 mm (6.88 inches), gap between pages 3.0 mm (0.12 inches)



When printing the status sheet with die-cut labels, the amount of remaining paper required depends on the paper width, paper length, and gap between pages. Since some combinations require paper lengths of up to 1,544 mm (60.8 inches), we recommend using continuous paper, continuous labels, or the included roll paper.

## Amount of Remaining Paper Required to Print a Status Sheet (Network Settings)

### Continuous paper / continuous label

If the paper width is 96.6 mm (3.80 inches) or more: 315.1 mm (12.41 inches)



Printing a status sheet (Network settings) with black mark detection still enabled may increase the amount of remaining paper required. We recommend using settings where black marks are not detected, even for paper with black marks, when printing.

### Die-cut label (included roll paper)

For the included roll paper, the status sheet (Network settings) can be printed with three labels.

Included roll paper: paper width 108.0 mm (4.25 inches), paper length 174.8 mm (6.88 inches), gap between pages 3.0 mm (0.12 inches)



We recommend using continuous paper, continuous labels, or the included roll paper. The recommended length for printing the status sheet (Network settings) on die-cut labels is 84.7 mm (3.33 inches) or more.

Status Sheet Example	Status Sheet (Network Settings) Example
<pre> &lt;Printer Status Sheet&gt; Sheet Output Time   YYYY.MM.DD hh:mm  &lt;Basic Information&gt; Model   XX-XXXX BK Serial Number   XXXXXXXXXX Main Firmware Version   XXXXXXXX MAC Address   XX:XX:XX:XX:XX:XX IP Address Setting   Auto/Manual IP Address   XXX.XXX.XXX.XXX Subnet Mask   XXX.XXX.XXX.XXX Gateway Address   XXX.XXX.XXX.XXX Head ID   XXXXXXXXXXXXXXXXXXXXXXXXXXXXXXXXXXXX   ... 03  xxxx      yyyy/mm/dd hh:mm 04  xxxx      yyyy/mm/dd hh:mm 05  xxxx      yyyy/mm/dd hh:mm 06  xxxx      yyyy/mm/dd hh:mm 07  xxxx      yyyy/mm/dd hh:mm 08  xxxx      yyyy/mm/dd hh:mm 09  xxxx      yyyy/mm/dd hh:mm 10  xxxx      yyyy/mm/dd hh:mm           </pre>	<pre> HHH NetWork Status Sheet HHH &lt;General Info&gt; MAC Address          xx:xx:xx:xx:xx:xx Firmware             xxxxxxxx &lt;Ethernet&gt; Network Status      Auto(Disconnected) &lt;TCP/IP IPv4&gt; Obtain IP Address   Manual IP Address          xxx.xxx.xxx.xxx Subnet Mask         xxx.xxx.xxx.xxx Default Gateway     xxx.xxx.xxx.xxx  HHHHHHHHHHH 1/1 HHHHHHHHHHH           </pre>



- You can also print a list of registered fonts, barcode fonts, images or templates.
- If the Wireless LAN Unit has been connected to the printer, wireless network status and settings are printed on the Network Settings section of the status sheet.

## Checking Network Connection and Settings

By printing the network connection check report, you can check the network connection status and the network settings.

On the operation panel, select the menu in the order shown below to print the report.

[Menu] - [General Settings] - [Network Settings] - [Connection Check]



### IMPORTANT

When printing the network connection check report, load paper that is 101.6 mm (4.00 inches) wide or more and 136.2 mm (5.36 inches) long or more.

## Amount of Remaining Paper Required to Print a Network Connection Check Report

### Continuous paper / continuous label

If the paper width is 101.6 mm (4.00 inches) or more: 280.6 mm (11.05 inches)



We recommend using continuous paper, continuous labels, or the included roll paper. The recommended length for printing the network connection check report on die-cut labels is 136.2 mm (5.36 inches) or more.

### Die-cut label (included roll paper)

For the included roll paper, the network connection check report can be printed with two labels.

Included roll paper: paper width 108.0 mm (4.25 inches), paper length 174.8 mm (6.88 inches), gap between pages 3.0 mm (0.12 inches)



When printing the network connection check report with die-cut labels, the amount of remaining paper required depends on the paper width, paper length, and gap between pages. Since some combinations require paper lengths of up to 531 mm (20.9 inches), we recommend using continuous paper, continuous labels, or the included roll paper.

### Network Connection Check Report Example

---

#### Check Network Connection

---

Check Result	Pass
--------------	------

---

Network is working correctly.

If your problems persist,  
see your documentation for help and networking tips.

---

#### Checked Items

---

Ethernet cable Connection Check	Pass
IP Address Check	Pass
Detailed IP Setup Check	Pass

---

#### Network Status

---

Printer Name	XX-XXXXX
Printer Model	XXXXXXXXXX
IP Address	XXX.XXX.XXX.XXX
Subnet Mask	XXX.XXX.XXX.XXX
Default Gateway	XXX.XXX.XXX.XXX
Mac Address	XX:XX:XX:XX:XX

# Setup

This chapter describes procedures for installing and setting up the printer that are required before using the printer.

## Unpacking

After unpacking, make sure that all the printer and the accessories are included and they have no damages. The included items are as follows.

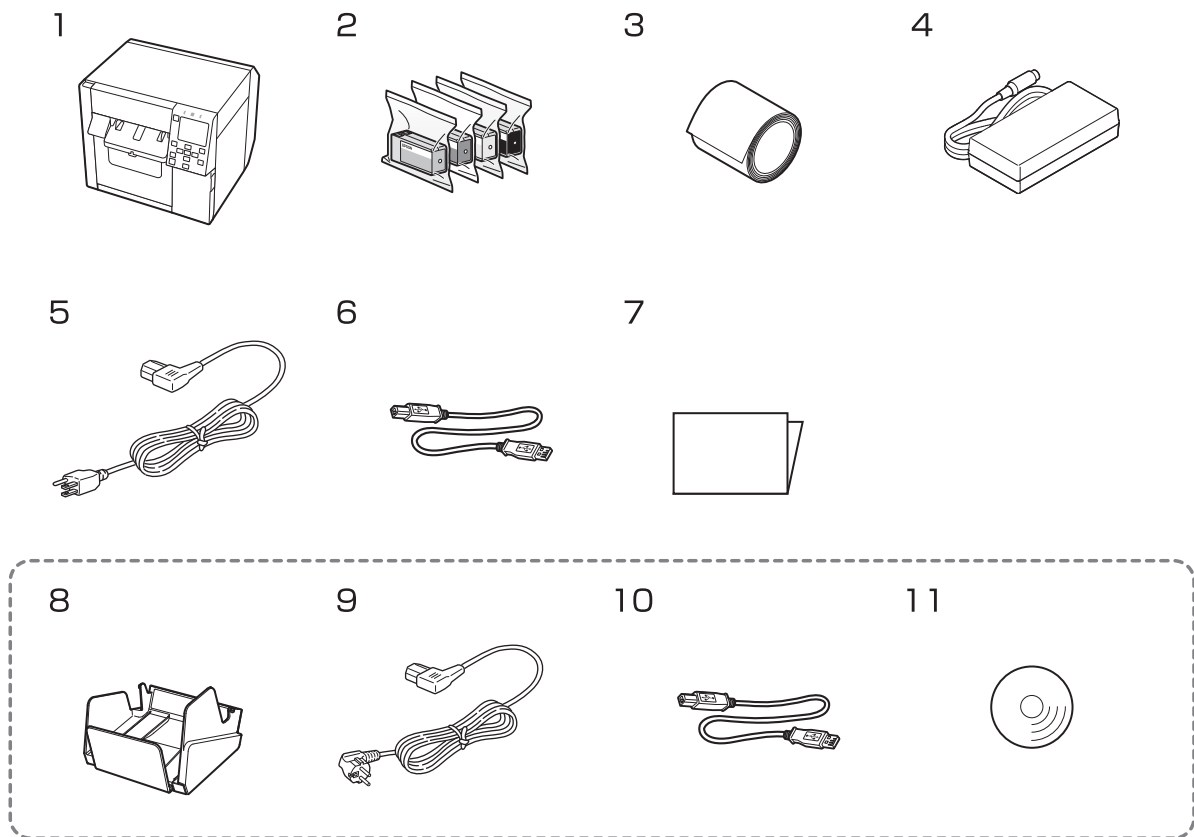

1	Printer (CW-C4000 Series)	2	Ink Cartridges C, M, Y, BK (MK)* (For initial ink charging) * Either one of a BK (gloss black) cartridge or MK (matte black) cartridge is included.
3	Roll paper (for initial operation check)	4	AC adapter
5	Power cable	6	USB cable
7	Manual	8*	OT-PT40 (paper tray)
9*	Power cable	10*	USB cable
11*	CD-ROM		

\* The item may not be included depending on the country or region.

## Removing the Protective Materials

Remove the all protective materials such as pieces of tape and cushion materials. Open the cover to remove some protective materials inside the printer.

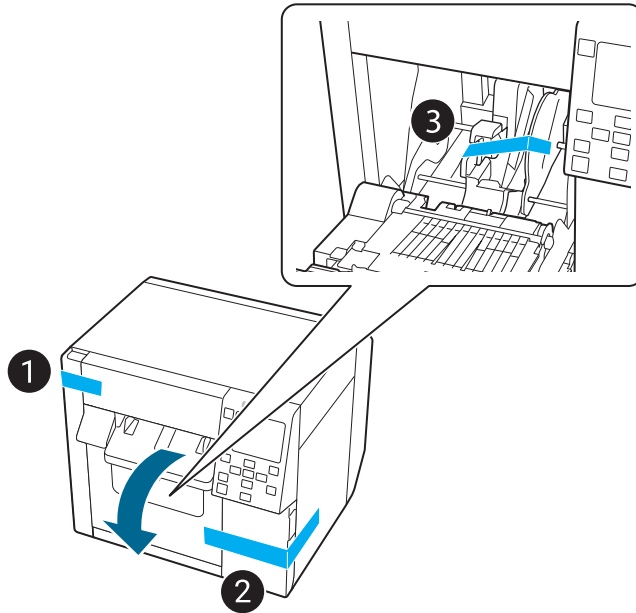

## Installing the Printer

Allow sufficient space for the printer. Make sure that the installation location meets the following requirements.

- On a level and stable surface with sufficient strength to support the weight of the printer (approx. 13.0 kg [28.66 lb]).
- On an area larger than the bottom surface of the printer.
- A location that is not subject to vibrations and impacts.
- A location where a dedicated power outlet is available.
- A location where you can load and remove paper without difficulty.
- A location with sufficient space around the printer to allow for installation of accessories, replacement of consumable products, and daily cleaning.
- A location that meets the following environmental requirements.

For details, see ["Environmental Specifications" on page 359](#).

		Temperature	Humidity
Printing		5 to 35°C	20 to 80% RH, No condensation
Storage	Gloss black ink	-15 to 40°C	5 to 85% RH, No condensation (without being unpacked)
	Matte black ink	-10 to 40°C	



If the printer has charged matte black ink and is more likely to be exposed to a temperature of -10 or lower degrees C, make sure to discharge ink before turning the printer off. Otherwise, the print head may be damaged due to freezing. For details, see ["Storing the Printer After Ink is Charged" on page 296](#).



## Connecting the Power Cable

Follow the procedure below to connect the power cable.



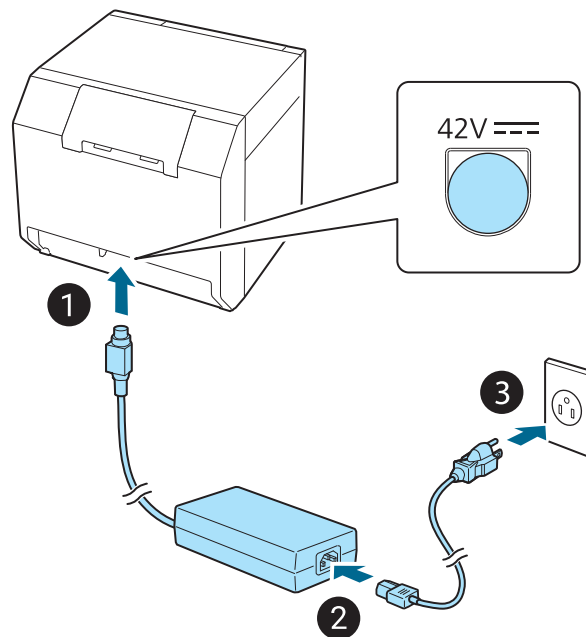

- Do not use other than the specified AC adapter (AC ADAPTER, K1 model number: M248B).
- Install the printer near a wall outlet so that you can disconnect the plug from the outlet immediately in the event of an emergency.

- 1** Insert the DC connector of the AC adapter all the way into the power connector of the printer.
- 2** Insert the connector of the power cable all the way into the AC inlet of the AC adapter.
- 3** Insert the power plug firmly all the way into an outlet with a ground.





## Turning On/Off

### Turning the Power On

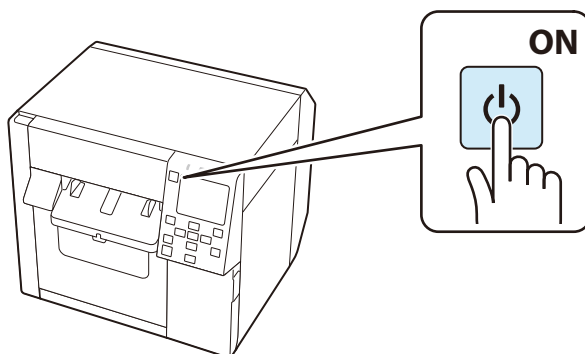
Hold down the  (power) button until the  (power) LED lights up.



### Turning the Power Off

Press the  (power) button. Then select [Yes] on the confirmation screen. The  (power) LED goes out and the printer is turned off.

## Setting Language and Date/Time

Follow the on-screen instructions to set language, the date and time.

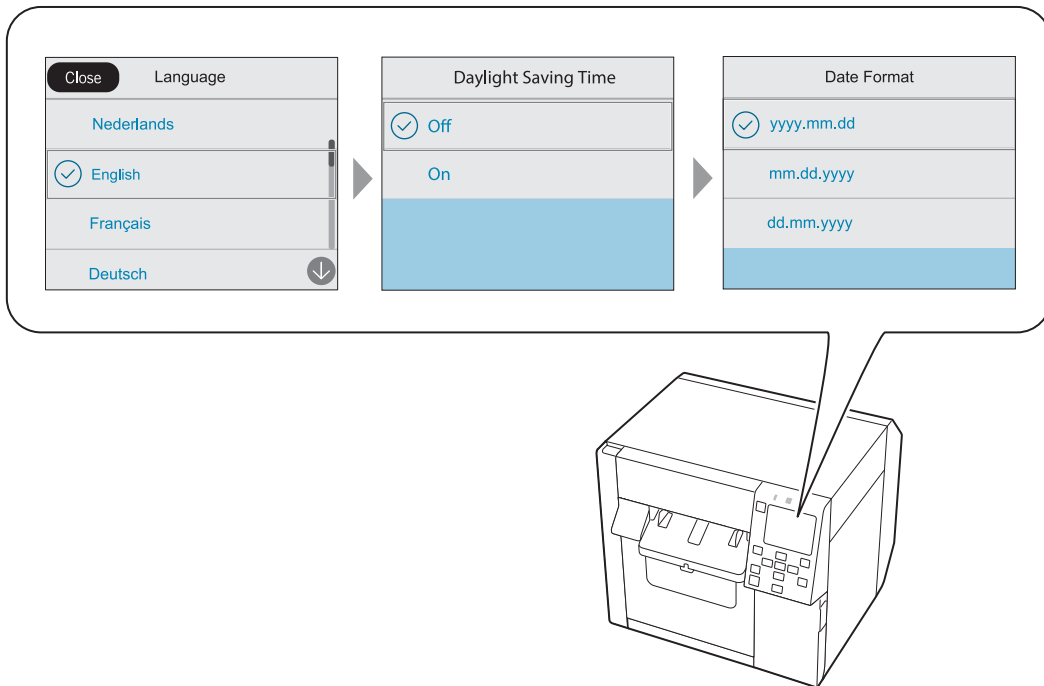

## Selecting Black Ink Type

Follow the on-screen instructions to select which type of black ink you use.

On the black ink type confirmation screen, select [Done].

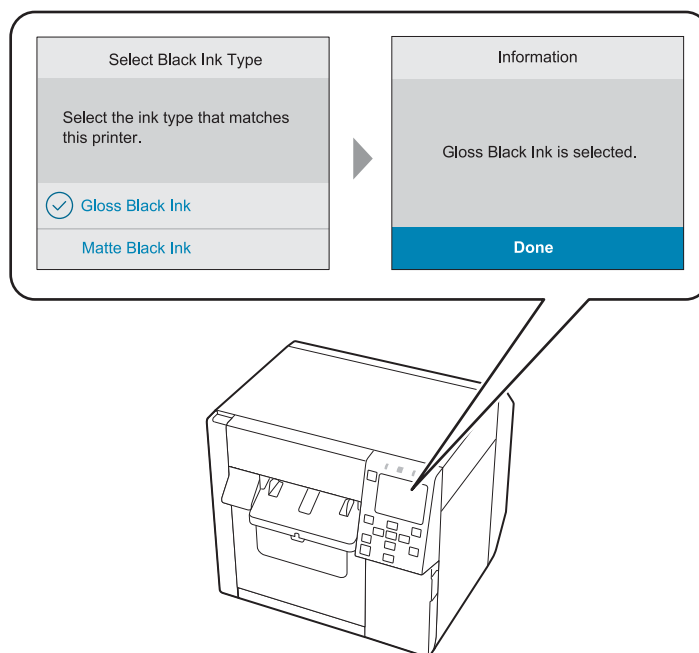

## Installing the Ink Cartridges

Shake and then install the ink cartridges following the on-screen instructions.

When you close the cover, a message that confirms whether to start initial ink charging is displayed. Select [Yes] to start the initial ink charging. When you see a message saying that the initial ink charging is finished, select [OK].

It takes about 19 minutes for the initial ink charging. The time differs according to circumstances.



**CAUTION**

Before installing the ink cartridges, make sure to read the cautions on handling the ink cartridges.

 ["Cautions on Ink Cartridges" on page 8](#)

Never open any cover of the printer or turn off the printer during ink charging.

Doing so will consume a large amount of ink, which may result in the need to replace the ink cartridges or the maintenance box before the completion of charging.

Once you start the initial ink charging, you cannot change the black ink type.

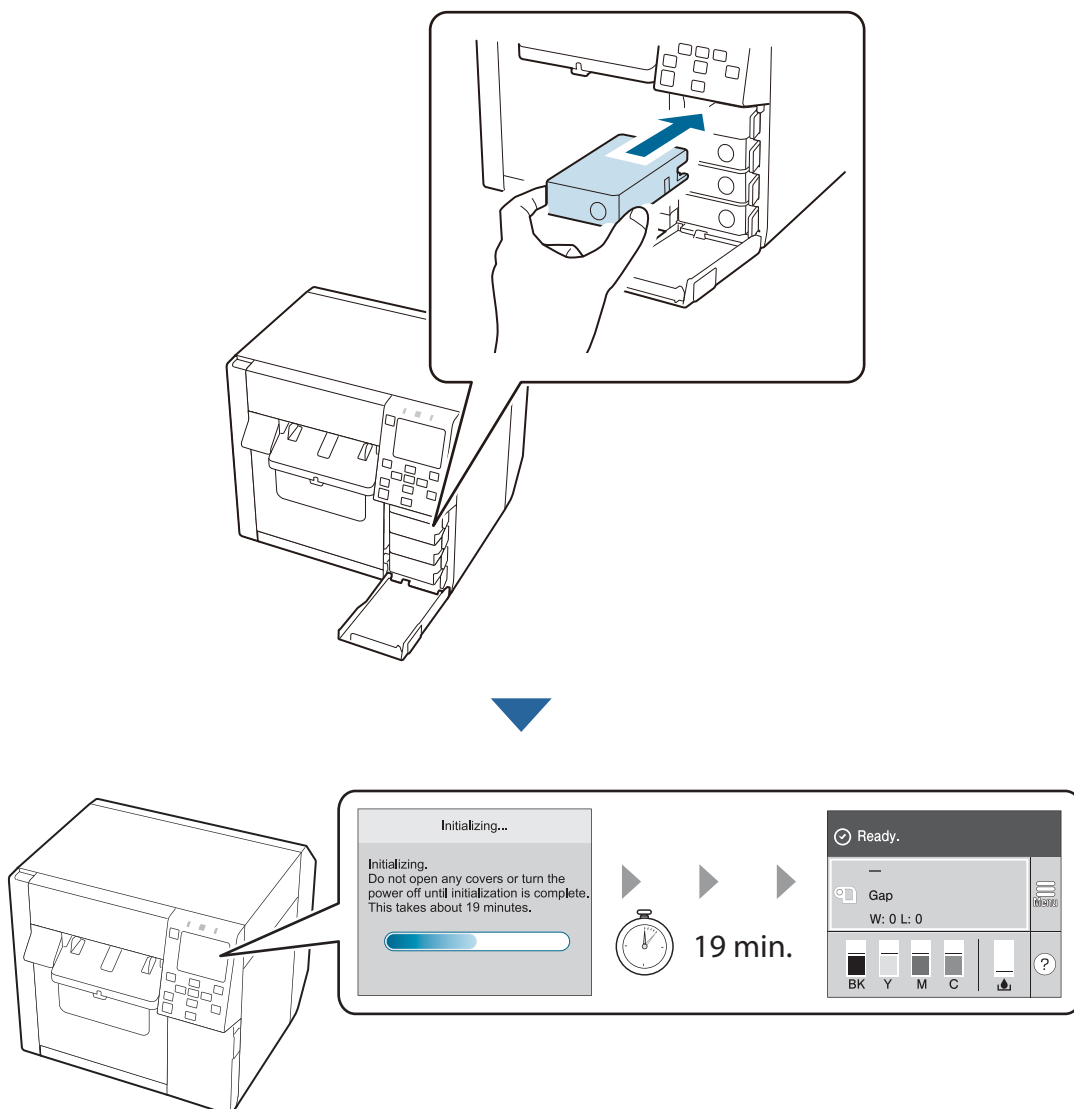

## Replacing the Ink Cartridges

### Checking Amount of Ink Remaining

You can check approximate remaining amount of ink on the operation panel or a computer.



Even when the printer is low on ink, you can print until you are prompted to replace the ink cartridge. Replace the ink cartridge as necessary.

### How to Replace the Ink Cartridges

The procedure below is for replacing the BK cartridge. Follow the same procedure for replacing the other color cartridges.



#### IMPORTANT

- When replacing the black ink cartridge, make sure to replace with a cartridge of the same type of black ink. The printer does not work if you install a cartridge of different type of black ink.
- Shake new ink cartridges well before installing them.

#### 1 Open the ink cartridge cover.

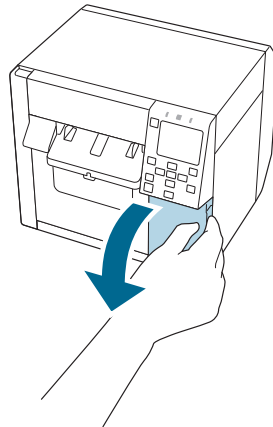

#### 2 Press the lever down to remove the used ink cartridge.

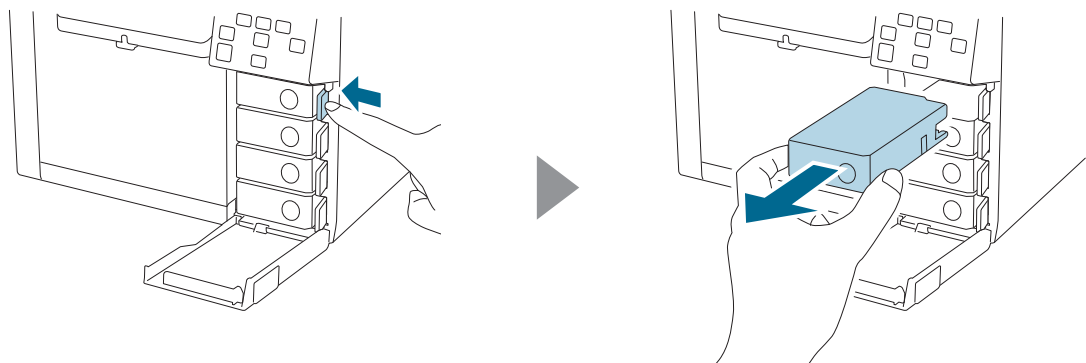

### 3 Shake the ink cartridge.

As shown in the figure below, shake the cartridge horizontally. Move the cartridge by about 5 cm to both directions, and repeat it about 15 times for about 5 seconds.

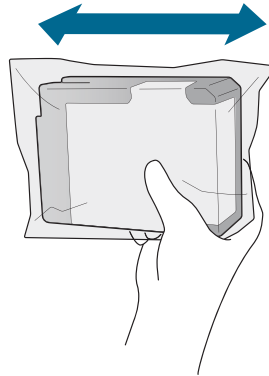

### 4 Take out the new ink cartridge from the bag.

 ["Cautions on Ink Cartridges" on page 8](#)

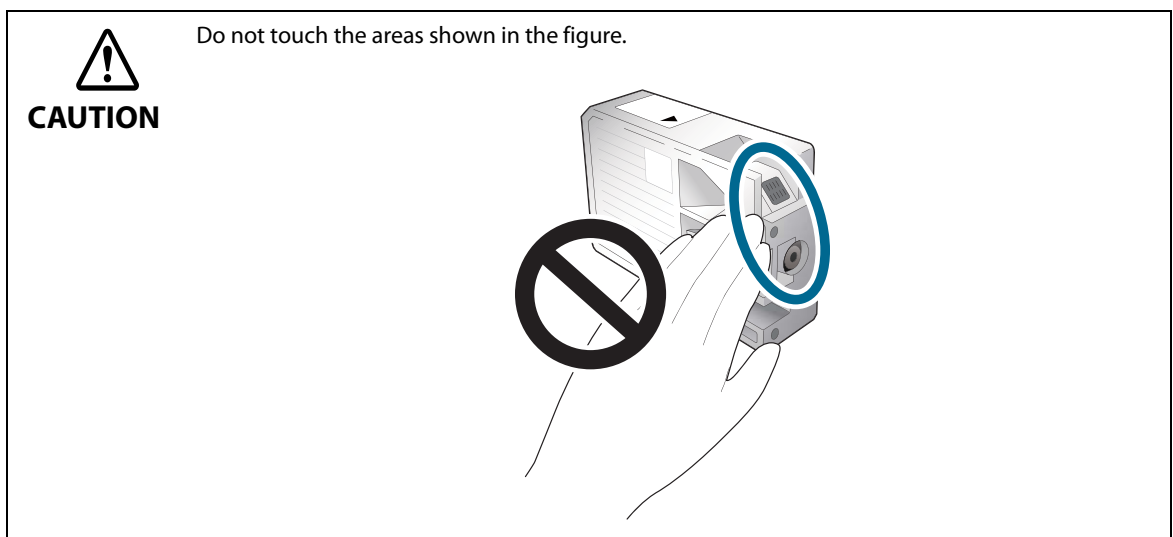
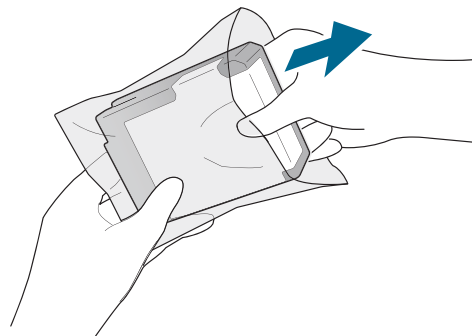

**5 Install the ink cartridge.**

Press the Push mark on the ink cartridge with your fingertip until it clicks into place.

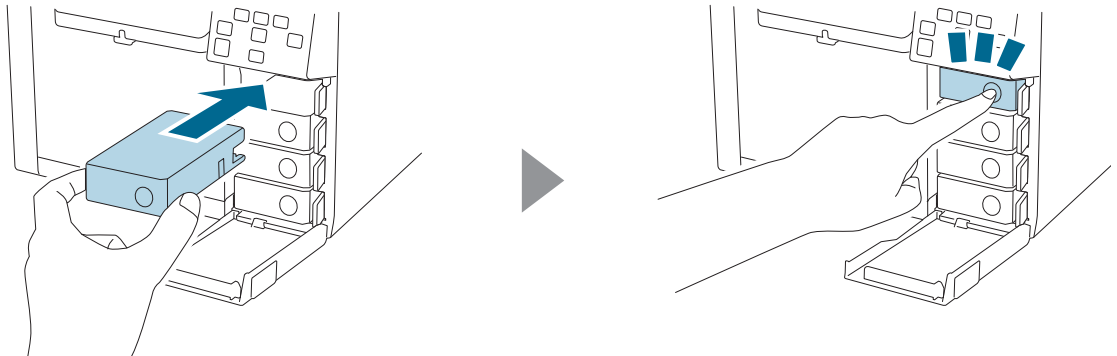
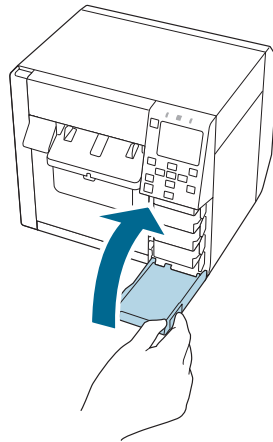
**6 Close the ink cartridge cover.**

## Replacing the Maintenance Box

This section describes how to replace the maintenance box.



Before handling the maintenance box, make sure to read the cautions on handling the maintenance box.

 ["Cautions on the Maintenance Box" on page 9](#)

## Checking the Amount of Empty Space in the Maintenance Box

You can check approximate amount of empty space in the maintenance box on the operation panel or a computer.



Even if the maintenance box is running low on space, you can still print until you are prompted to replace it. Replace the maintenance box with a new one as necessary.

## How to Replace the Maintenance Box

- 1 Open the maintenance box cover.

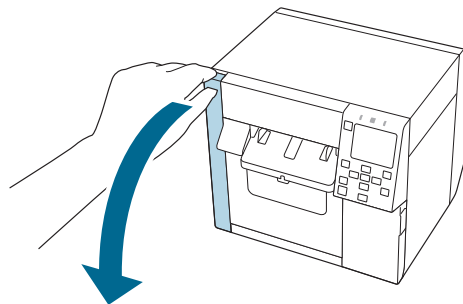

- 2 Take out the maintenance box.

When disposing of the used maintenance box, put it in a plastic bag that came with the new maintenance box.

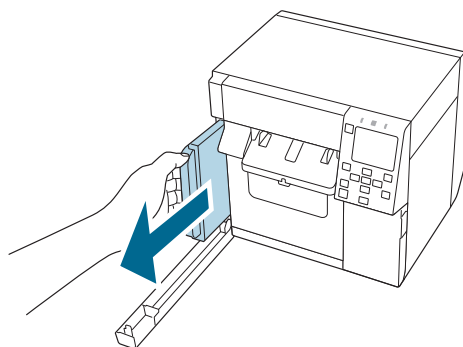



- 3** Take out a new maintenance box from the bag.  
📖 "Cautions on the Maintenance Box" on page 9

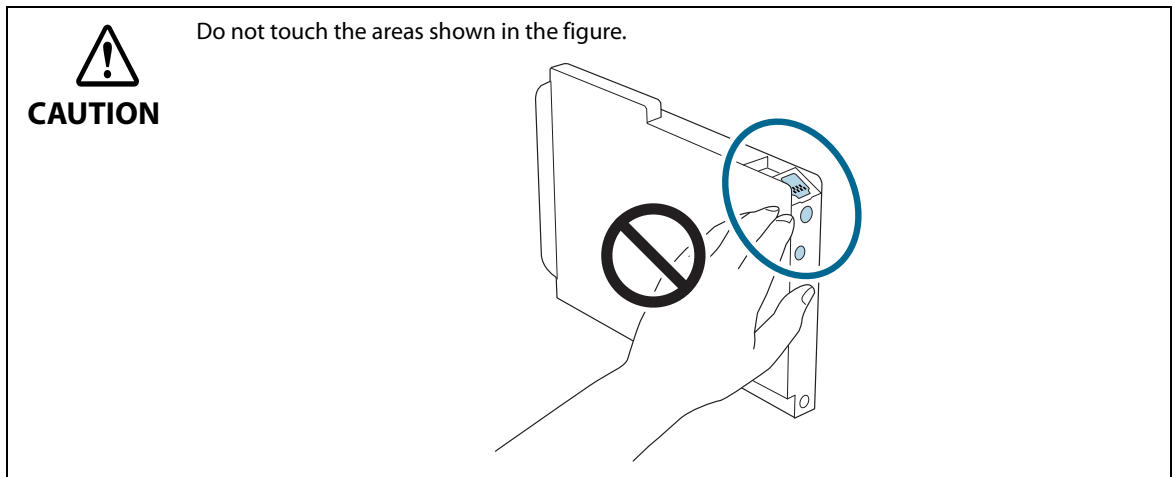
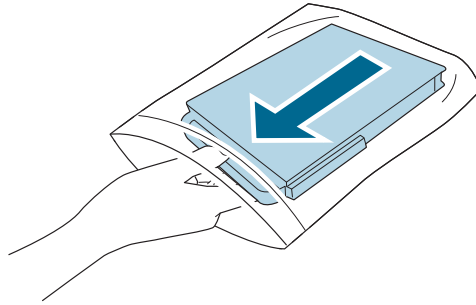

- 4** Insert the new maintenance box all the way in.

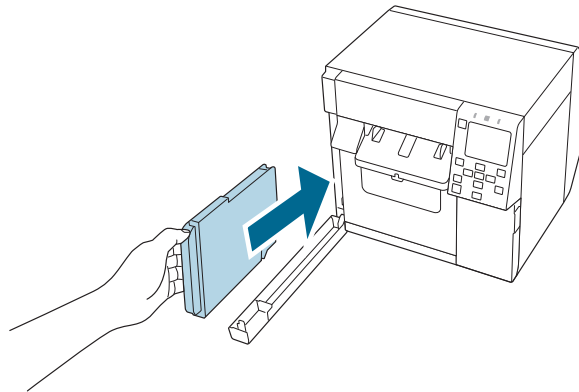

## 5 Close the maintenance box cover.

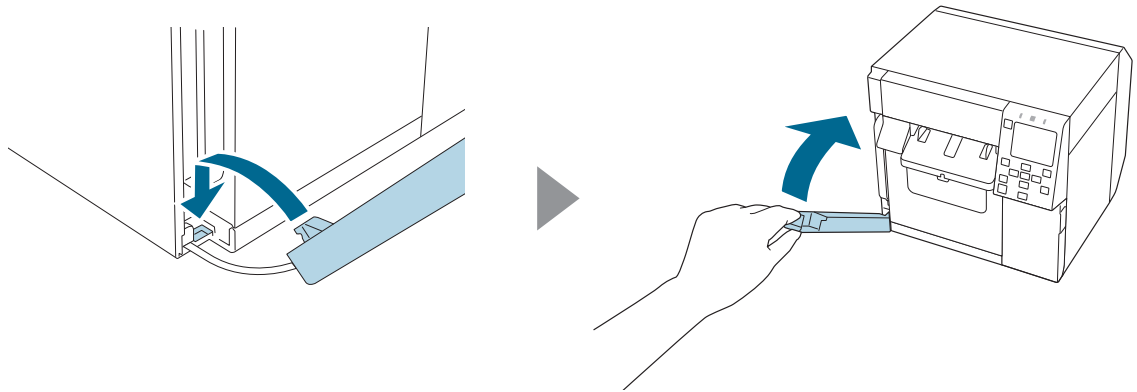

## 6 Press the **||** (Pause) button.

Check that the printer is ready for printing by checking the home screen.

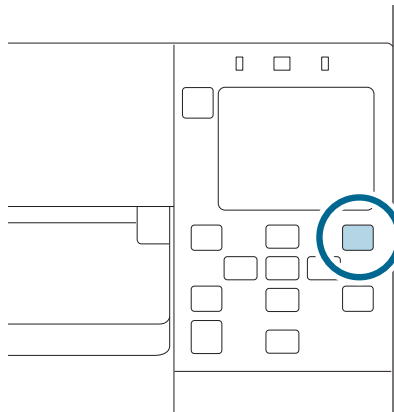

It is recommended to clean the platen at the same time you replace the maintenance box.

 ["Cleaning the Platen" on page 287](#)

The non-woven cloth and cotton swabs used for cleaning are included in the replacement maintenance box.

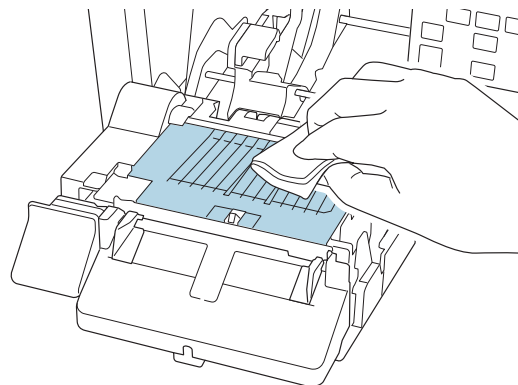

## Installing the Printer Driver and Connecting to a Computer

There are the following two methods to install the printer driver on a computer and connect the printer to the computer.

- Setup using Install Navi
- Setup without using Install Navi

### Setup using Install Navi

Just by following the on-screen instructions of Install Navi, you can install the printer driver and connect the printer to the computer.

Follow the procedure below to set up using Install Navi.

- 1 Turn on the computer.**
- 2 Check that the printer is powered on.**
- 3 Download Install Navi from the website shown in "Downloading Printer Driver, Utilities, and Manuals" on page 365, then start it.**  
If a CD-ROM is included in the package, set it on your computer. Install Navi will start automatically. If Install Navi does not start automatically, double-click InstallNavi.exe.
- 4 The screen below appears when Install Navi starts. Read and accept the software licensing agreement, and then click [Next]. For the subsequent steps, follow the on-screen instructions.**

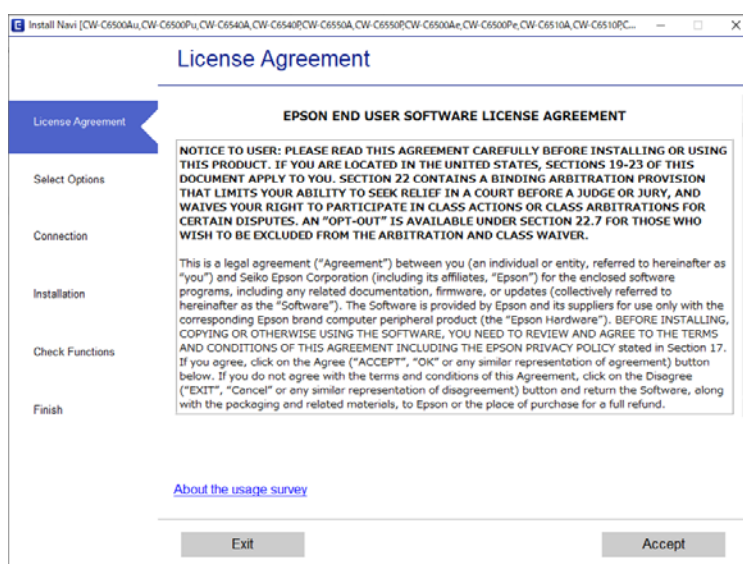

Install Navi will guide you to install the printer driver, PrinterSettings, and other software. The setup can be completed even if you skip the installation of software. In that case, you can install the software later.

Installing the printer driver and connecting to a computer are now complete.

## Setup without using Install Navi

### How to Get the Software

You can get the software from the following website.

For customers in North America, go to the following web site: [https://support.epson.net/p\\_doc/96a/](https://support.epson.net/p_doc/96a/)

For customers in other countries and regions, go to the following web site: <https://www.epson-biz.com/>

### How to Connect to a Computer or Smart Device

- When connecting via USB or Wired LAN  
Connect the interface cable to be used to the connector on the back of the printer.
- When connecting via Wireless LAN  
Connect the optional Wireless LAN Unit (OT-WL06) to the connector on the back of the printer.

#### Connecting to Wired LAN

Connect to the network with a LAN cable and check the connection.

- 1 Connect the printer and a hub (or LAN switch) with a LAN cable.**
- 2 Select [Menu] on the home screen.**
- 3 Select [General Settings] - [Network Settings] - [Connection Check].**  
The result of the check is displayed. Check that the printer is connected the network successfully.

#### Connecting to Wireless LAN (Wi-Fi)

By connecting the optional Wireless LAN Unit (OT-WL06) to the printer, the printer can communicate over a wireless LAN. There are several ways to connect the printer to a wireless LAN (Wi-Fi). Select the connection method that best suits your environment and conditions.

For information (SSID, password) of the wireless LAN router (access point), please check your router or if inaccessible then contact your network administrator.

- "Wi-Fi Setup Wizard" on page 53
- "Push Button Setup (WPS)" on page 57



By using Wi-Fi Direct, you can connect directly to the printer via wireless LAN without using a wireless LAN access point.

- "Connecting to an iOS Device via Wi-Fi Direct" on page 59
- "Connecting to Other Devices via Wi-Fi Direct" on page 61



- If  is not displayed on the home screen, check that the optional Wireless LAN Unit is properly connected, and turn the printer off and then back on.
- When Wi-Fi Direct is enabled, the printer acts as an access point and can be connected to up to eight devices.

## Wi-Fi Setup Wizard

- 1 Connect the optional Wireless LAN Unit to the printer, and turn the printer on.
- 2 Press   to select  on the printer's home screen, and then press the OK button.

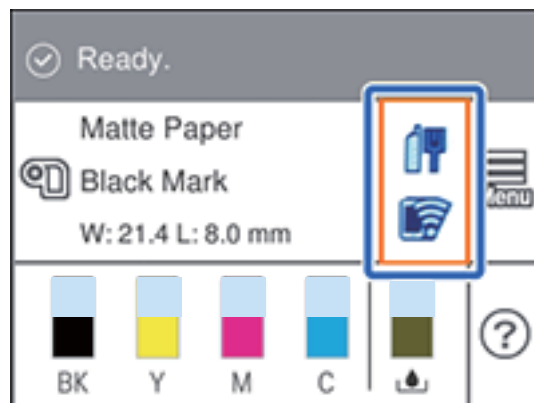

- 3 Select [Router], and then press the OK button.

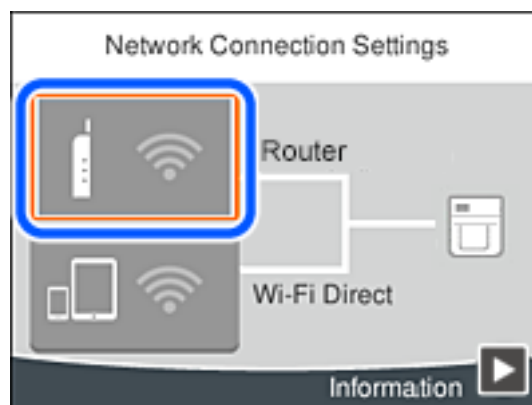

- 4 Press the OK button.



- 5 Select [Wi-Fi Setup Wizard], and then press the OK button.



- 6 On the printer's control panel, select the network name (SSID) for the wireless router that you want to connect to.



- 7 Select the [Enter Password] on the [Enter Manually] screen, and then press the OK button.

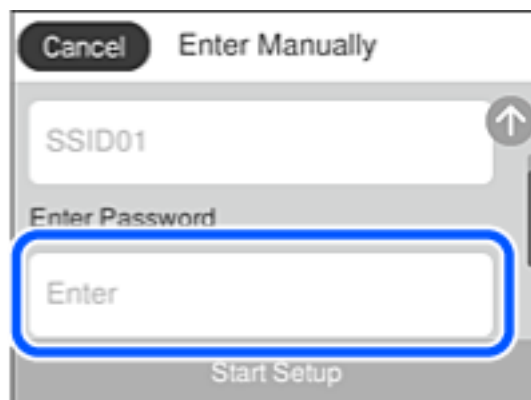

If you enter the SSID manually, set [Password] to [Available], select [Enter Password], and then press the OK button.

## 8 Enter the Wi-Fi password.



- The password is case-sensitive.
- If you do not know the password, check if the information is written on the label of the wireless router. On the label, the password may be identified as a "Network Key," "Wireless Password", and so on. If you are using the wireless router at its default settings, use the password written on the label.

## 9 When you have finished, select [OK], and then press the OK button.



## 10 Check the settings, select [Start Setup], and then press the OK button.



## 11 Press the OK button.



The screen automatically proceeds after a specific length of time if you do not press OK button.



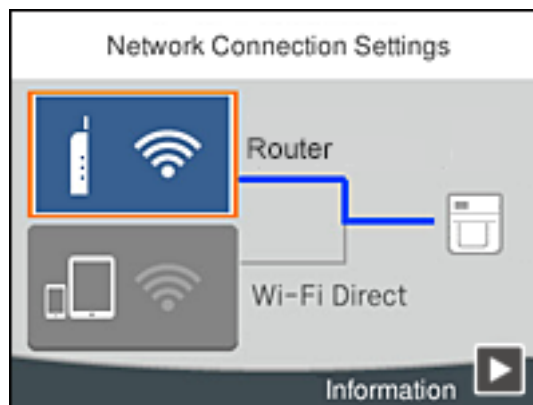

If you fail to connect, make sure paper is loaded, and then print a connection report. Select [Print Check Report], and then press the OK button.

## 12 Press the button.





### Push Button Setup (WPS)

- 1 Connect the optional Wireless LAN Unit to the printer, and turn the printer on.
- 2 Press   to select  on the printer's home screen, and then press the OK button.

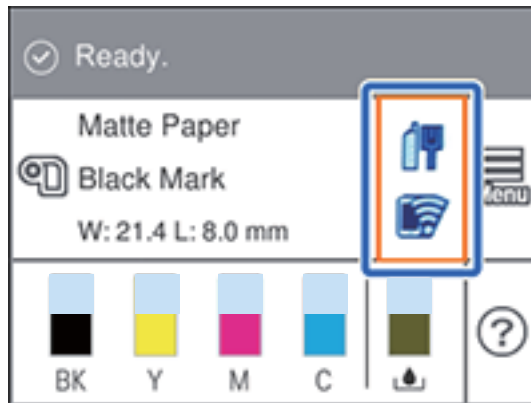

- 3 Select [Router], and then press the OK button.

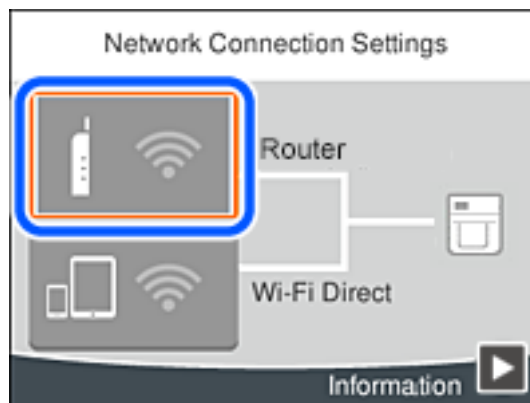

- 4 Press the OK button.



- 5** Select [Push Button Setup (WPS)], and then press the OK button.



- 6** Hold down the [WPS] button on the wireless router until the security light flashes. If you do not know where the [WPS] button is, or there are no buttons on the wireless router, see the documentation provided with your wireless router for details.

- 7** Press the OK button on the printer's control panel.



- 8** Press the OK button.



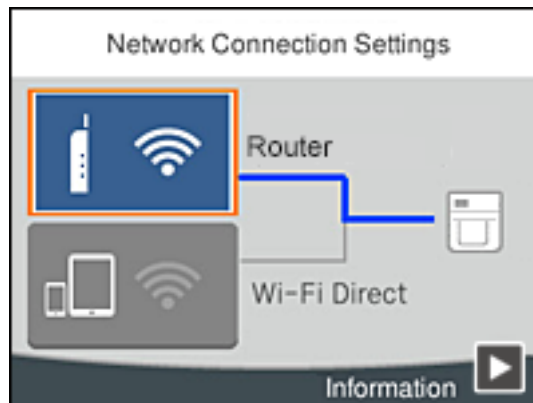

The screen automatically proceeds after a specific length of time if you do not press the OK button.

- 9 Press the  button.



### Connecting to an iOS Device via Wi-Fi Direct

- 1 Connect the optional Wireless LAN Unit to the printer, and turn the printer on.
- 2 Press   to select  on the printer's home screen, and then press the OK button.

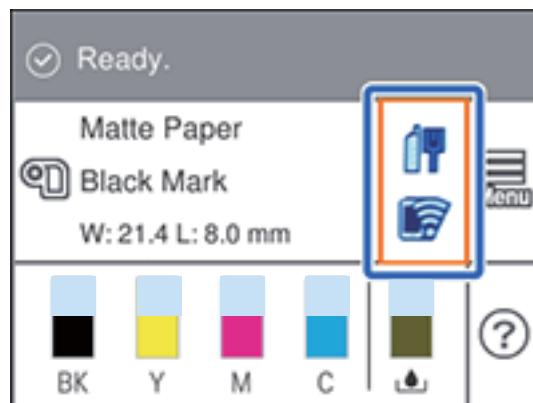

- 3 Select [Wi-Fi Direct], and then press the OK button.

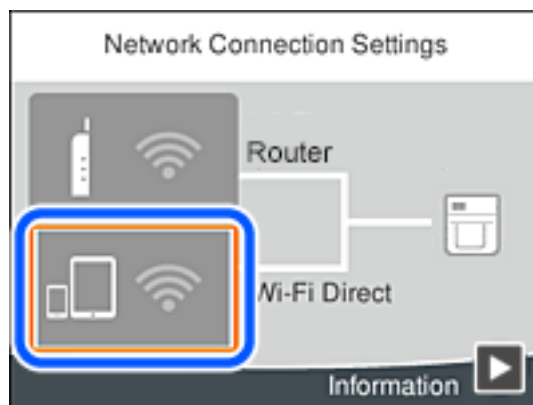

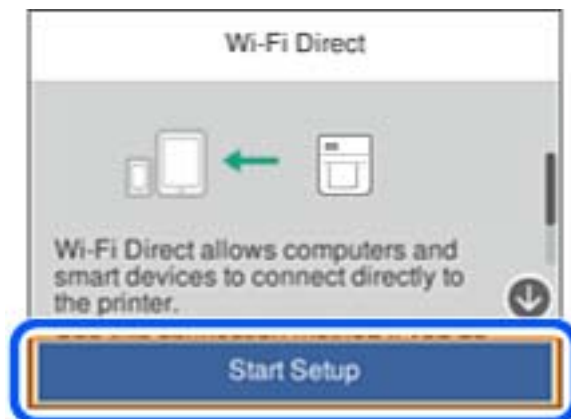
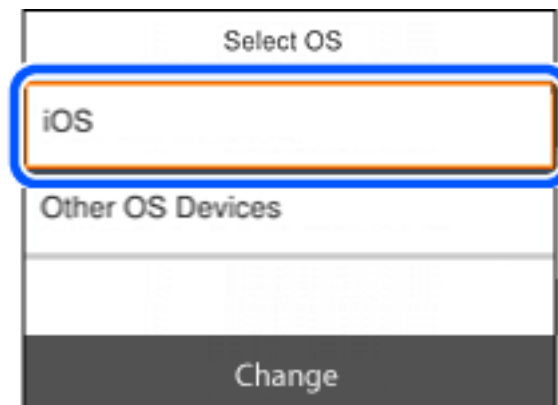
**4** Press the OK button.**5** Select [iOS], and then press the OK button.

A QR code is displayed on the printer screen.

**6** Open the OS-standard camera app.

This does not work with code reading apps.

**7** Scan the QR code in Photo mode and tap the notification that appears to connect to the printer.

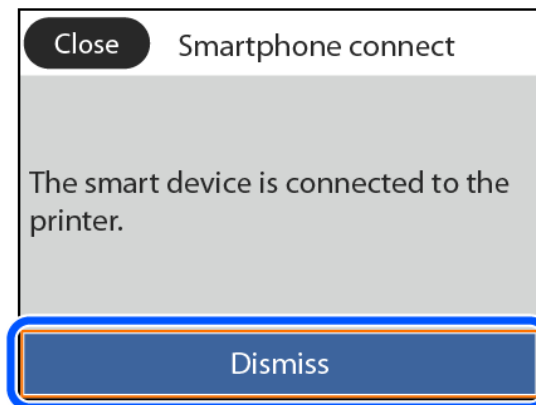

- 8 Press the OK button.

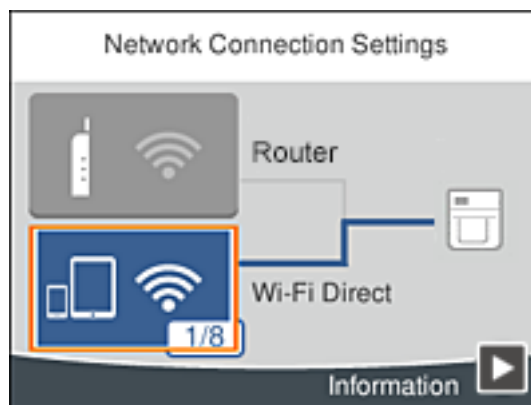

- 9 Press the  button.



### Connecting to Other Devices via Wi-Fi Direct

- 1 Connect the optional Wireless LAN Unit to the printer, and turn the printer on.
- 2 Press   to select  on the printer's home screen, and then press the OK button.

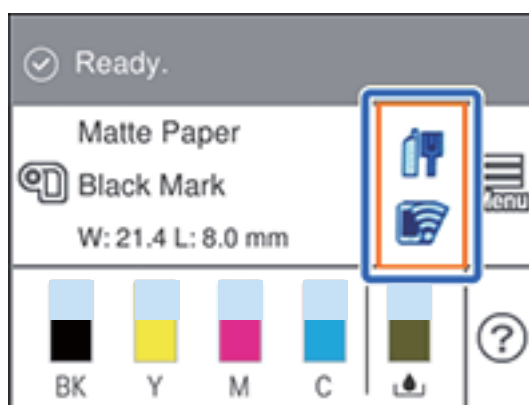

- 3** Select [Wi-Fi Direct], and then press the OK button.

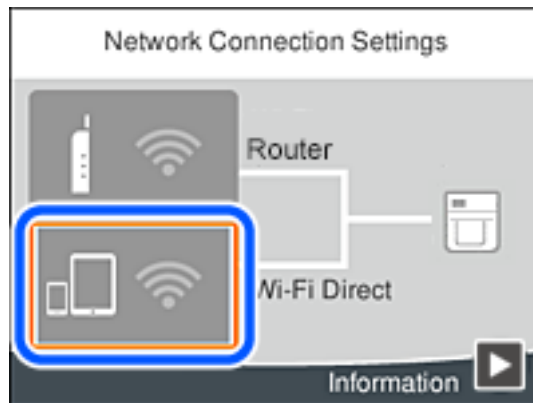

- 4** Press the OK button.

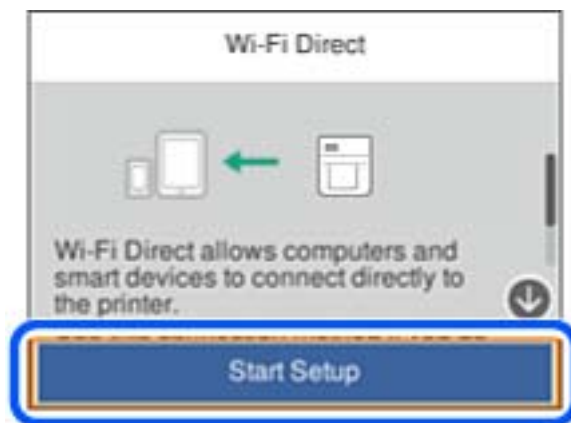

- 5** Select [Other OS Devices], and then press the OK button.

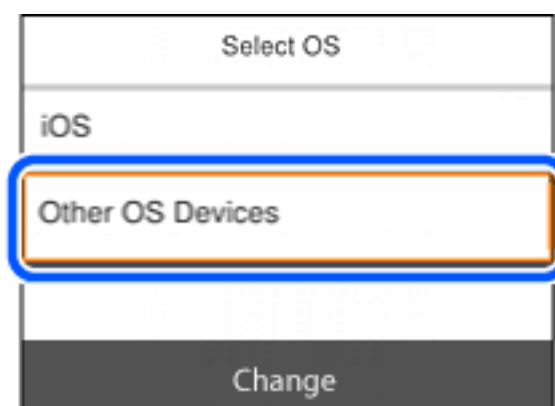

- 6 Perform this step on your computer. On the computer's network connection screen, select the SSID displayed on the printer's control panel.

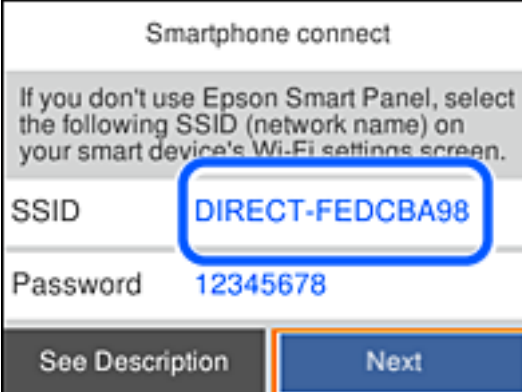

Smartphone connect

If you don't use Epson Smart Panel, select the following SSID (network name) on your smart device's Wi-Fi settings screen.

SSID **DIRECT-FEDCBA98**

Password 12345678

See Description Next

- 7 Enter the password displayed on the printer's control panel on the computer to connect to the printer.

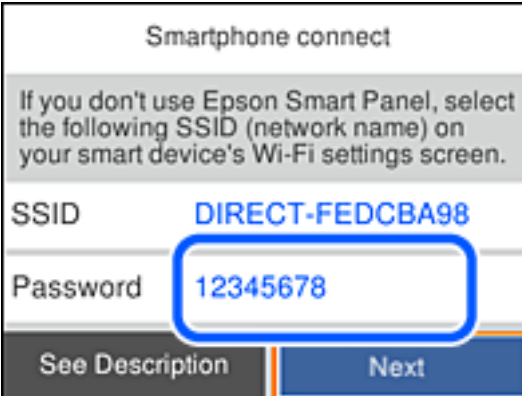

Smartphone connect

If you don't use Epson Smart Panel, select the following SSID (network name) on your smart device's Wi-Fi settings screen.

SSID **DIRECT-FEDCBA98**

Password **12345678**

See Description Next

- 8 After the connection is established, select [Next], and then press the OK button.



Close Smartphone connect

If you don't use Epson Smart Panel, select the following SSID (network name) on your smart device's Wi-Fi settings screen.

SSID **DIRECT-FEDCBA98**

Password 12345678

See Description **Next**

- 9 Press the  button.

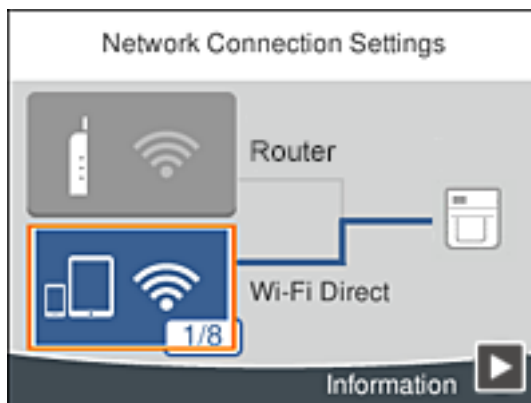

---

## How to Configure the Network Settings

Follow the procedure below to set up the IP address of the printer.

- 1 Select [Menu] on the home screen.
- 2 Select [General Settings] - [Network Settings] - [Advanced] - [TCP/IP].
- 3 Select [TCP/IP Setting Method] and then select [Auto] or [Manual].  
When you select [Auto], the network setting is complete.  
When you select [Manual], proceed to step 4.
- 4 Enter the IP address and the subnet mask.  
Select a setting to change and then press the [OK] button to enter the information.
- 5 Select [Start Setup].

The network setting is now complete.



## Media Settings

Configure the media source to use, and type, shape, detecting method of media to use.

- Setting using the printer driver

- [Printer Driver for Windows](#)

- [Printer Driver for Mac](#)

- [Printer Driver for Linux](#)

- Changing the settings on the printer

- [PrinterSetting \(Windows\)](#)

- [Epson Label Printer Utility](#)

- [Epson Label Printer Utility for Linux](#)

- [WebConfig](#)

- [Operation Panel](#)



- If the settings on the printer (settable using the operation panel, PrinterSettings, or WebConfig) differ from the printer driver settings, printing is performed by applying the printer driver settings.
- For media that can be used with this product, refer to "[Paper Specifications](#)" on page 344.

## Loading Paper

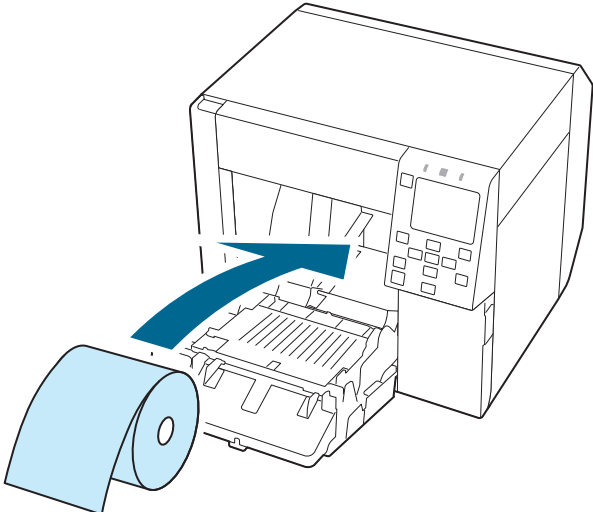
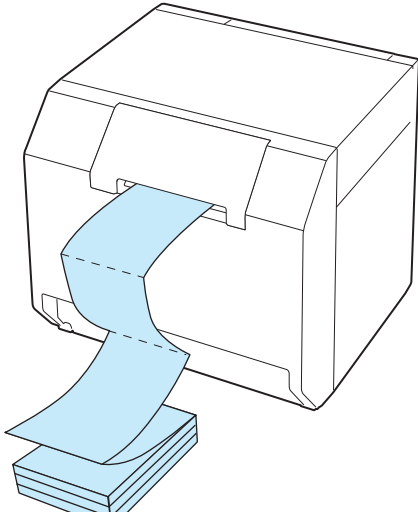

This section describes how to load and replace paper. The procedure for replacing paper differs depending on whether to supply paper from inside or outside the printer. Videos that show the procedure are also available. Click the URL below to view the videos.

[https://support.epson.net/p\\_doc/968/](https://support.epson.net/p_doc/968/)

Supply from Inside (Internal)	Supply from Outside (Rear Feed)
<p>Paper is supplied from inside the printer. Set roll paper into the printer.</p> 	<p>Paper is supplied from outside the printer. Place roll paper or fanfold paper behind the printer.</p> 



### IMPORTANT

- To supply roll paper from outside the printer, prepare an external paper feeder and paper rewriter by yourself. For more details, contact qualified service personnel for advice.
- When replacing paper with a different shape, form, or type of paper, change the paper settings either from the operation panel or on the printer driver before loading the paper.
  -  ["Operation Panel Settings" on page 230](#)
  -  ["Paper Source and Paper Detection Settings" on page 91](#)
  -  ["User-Defined Paper" on page 93](#)

## Loading Roll Paper



After turning on the printer, wait until the home screen is displayed, and then open the front cover. If you open the cover before the home screen is displayed, the printer may fail to load the paper correctly.

- 1** Turn the printer on.
- 2** Open the front cover.

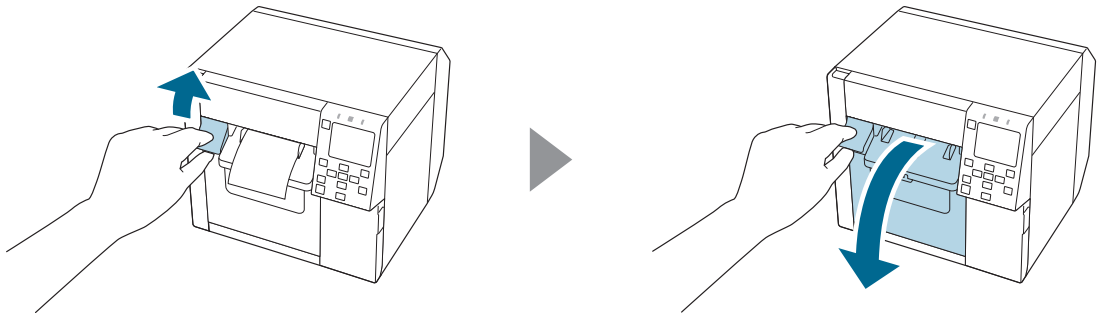

- 3** If the paper feed guide has been attached, remove it.

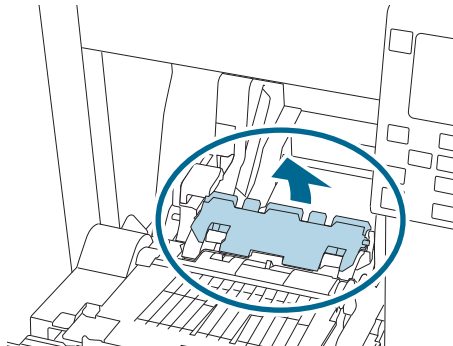

- 4** Raise the lock lever of the roll paper guides.

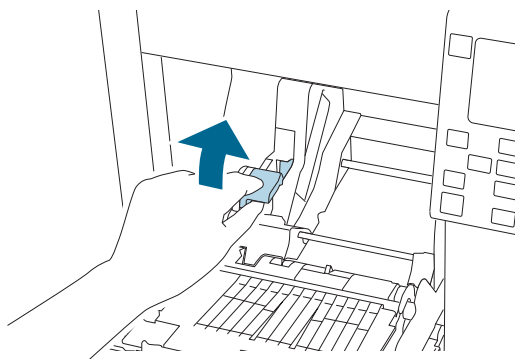

- 5** Slide the roll paper guides outward as far as they go.

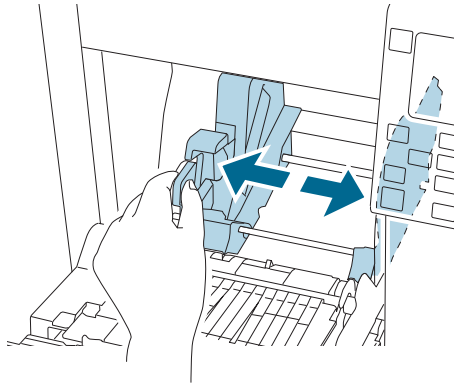

- 6** Lower the lock lever of the roll paper guides.

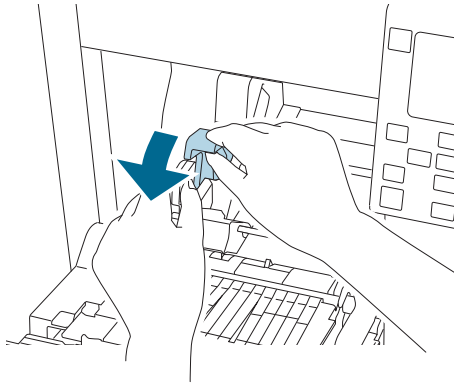

- 7** Insert paper with the printable side face up.

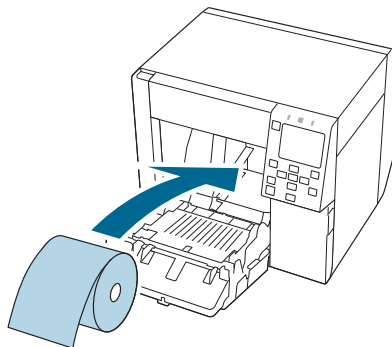

- 8** Raise the lock lever of the roll paper guides.

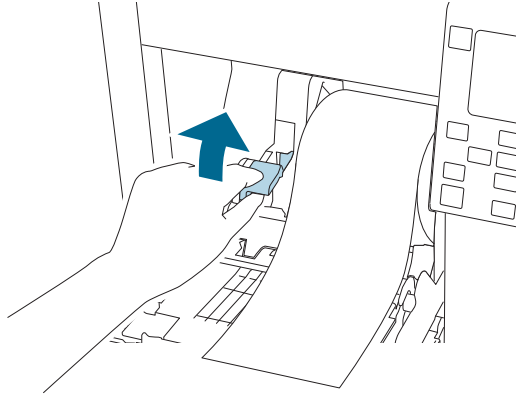

- 9** Slide the roll paper guides against the paper.

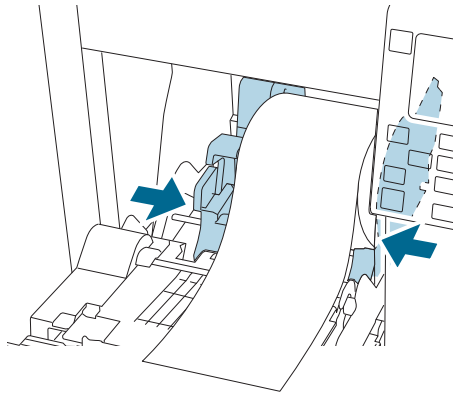

- 10** Lower the lock lever of the roll paper guides.

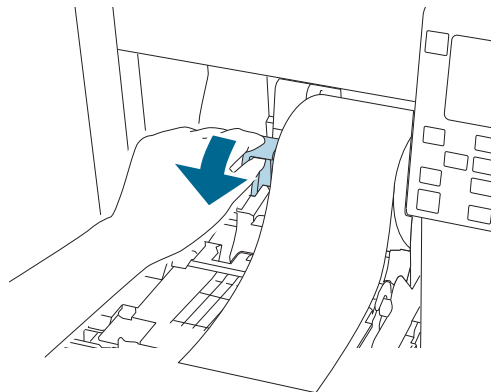

- 11** According to the paper width, open and/or close the platen shutters following the instructions on the label attached to the top surface of the printer.

 "Adjusting the Shutters" on page 78

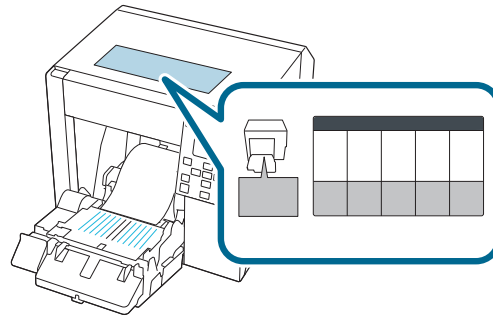

- 12** Lower the lock lever of the paper ejection guides.

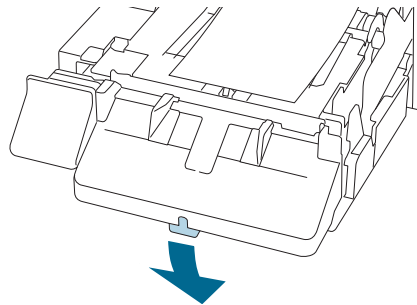

- 13** Slide the paper ejection guides outward.

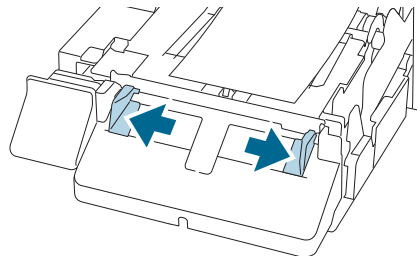

- 14** Pull out the paper as shown.

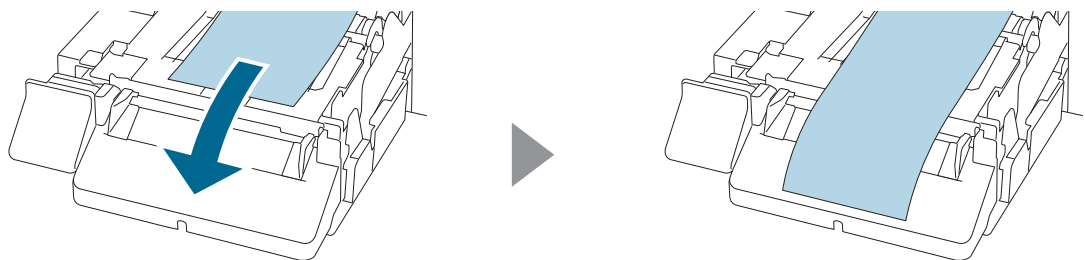

- 15** Hold down the paper by hand, and slide the paper ejection guides against the paper.

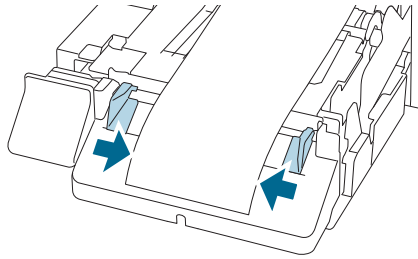

- 16** Raise the lock lever of the paper ejection guides until it clicks into place.

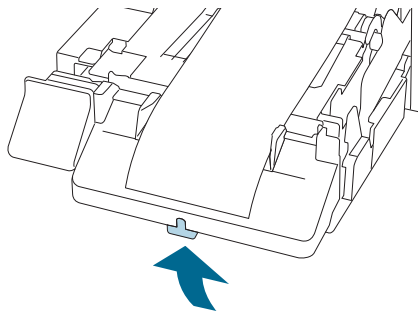

- 17** Pull out the leading edge of the roll paper, and then close the front cover.

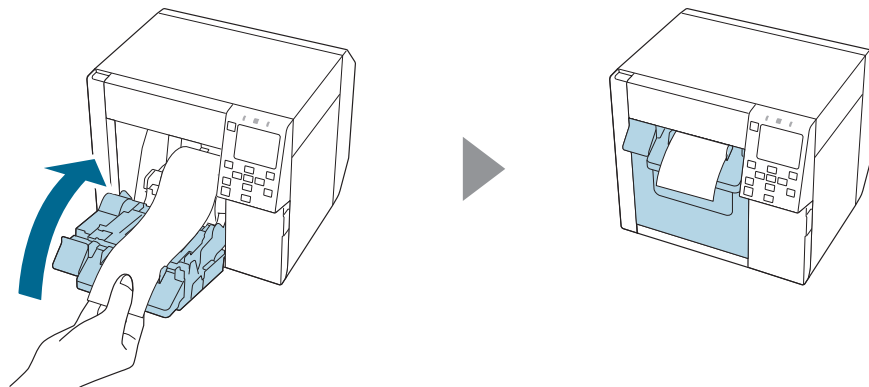

**18** Press the **||** (Pause) button.

Check that the printer is ready for printing by checking the home screen.

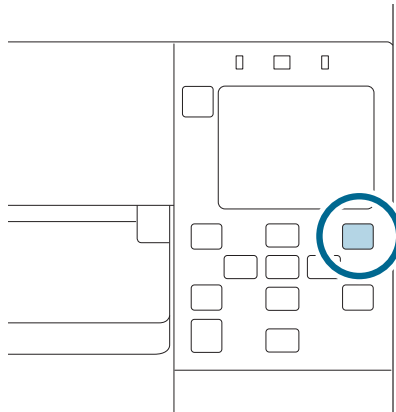



## Loading Fanfold Paper



After turning on the printer, wait until the home screen is displayed, and then open the front cover. If you open the cover before the home screen is displayed, the printer may fail to load the paper correctly.

**1** Turn the printer on.

**2** Open the front cover.

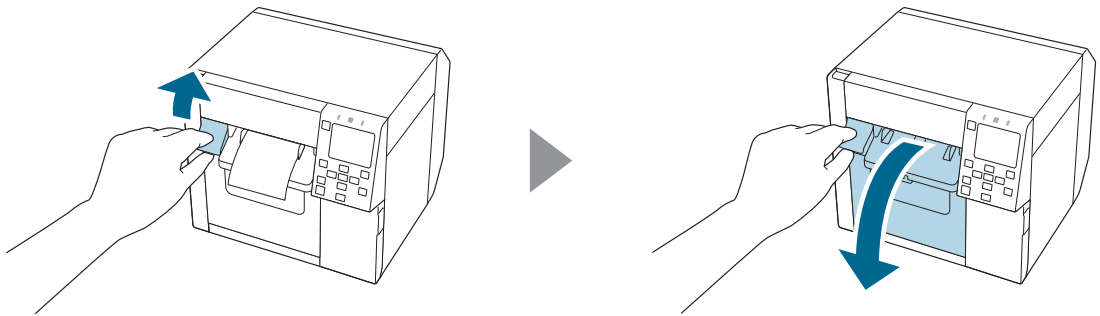

**3** Open the rear cover.

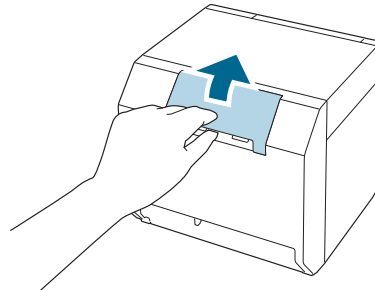

**4** Remove the paper feed guide, and then close the rear cover.

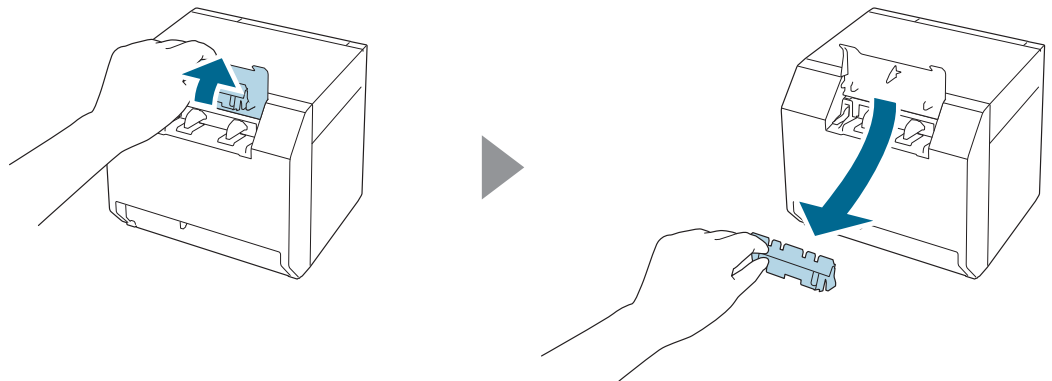

## 5 Attach the paper feed guide.

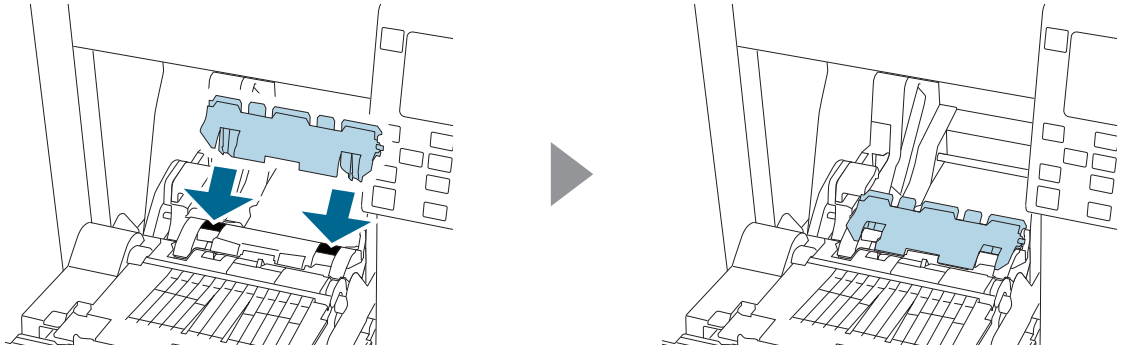

## 6 According to the paper width, open and/or close the platen shutters following the instructions on the label attached to the top surface of the printer.

 ["Adjusting the Shutters" on page 78](#)

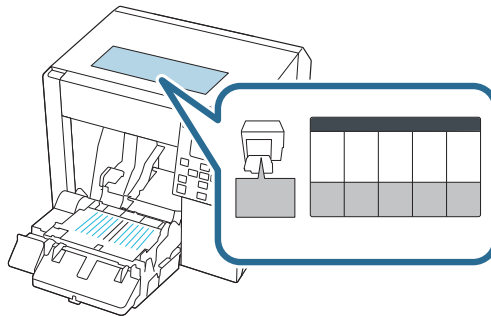

## 7 Lower the lock lever of the paper ejection guides.

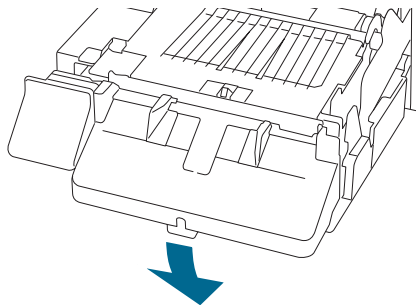

## 8 Slide the paper ejection guides outward as far as they go.

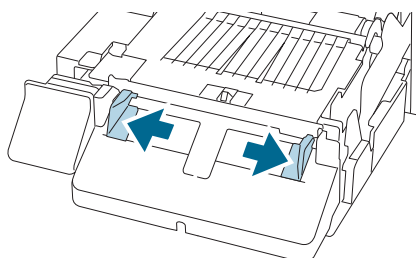

- 9** Raise the lock lever of the paper ejection guides until it clicks into place.

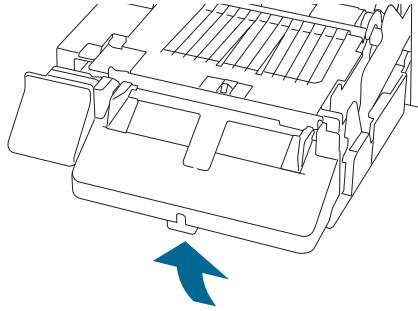

- 10** Close the front cover.

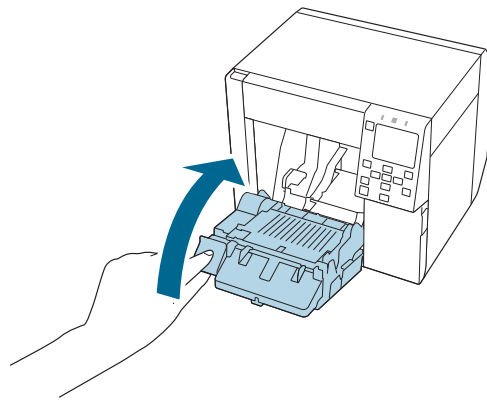

- 11** Open the rear cover.

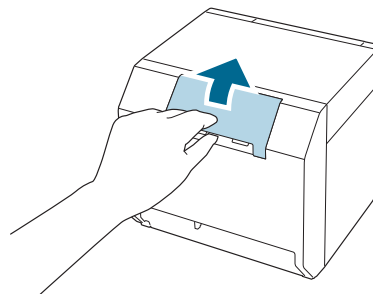

- 12** Raise the lock lever of the fanfold paper guides.

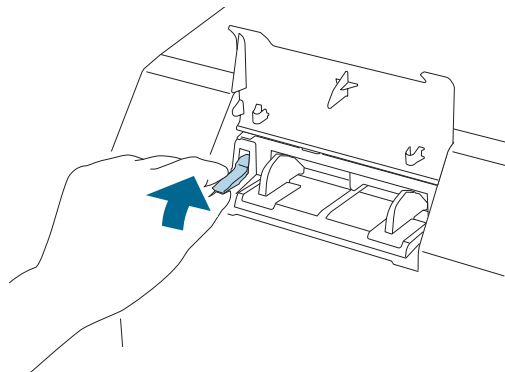

### 13 Place the fanfold paper behind the printer.

- Place the fanfold paper at least 40 mm away from the printer.
- Make sure the paper is vertical in relation to the paper feed slot.

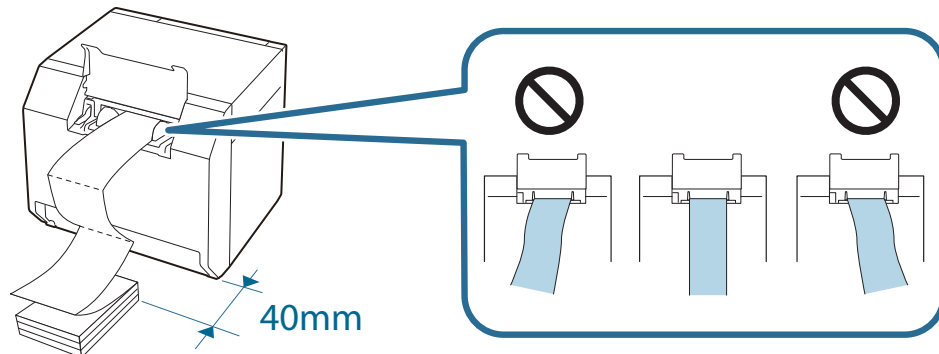

### 14 Slide the fanfold paper guides against the paper.

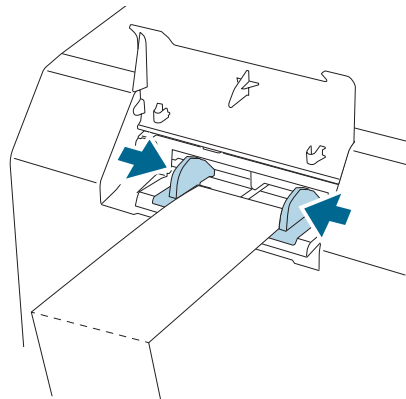

### 15 Lower the lock lever of the fanfold paper guides.

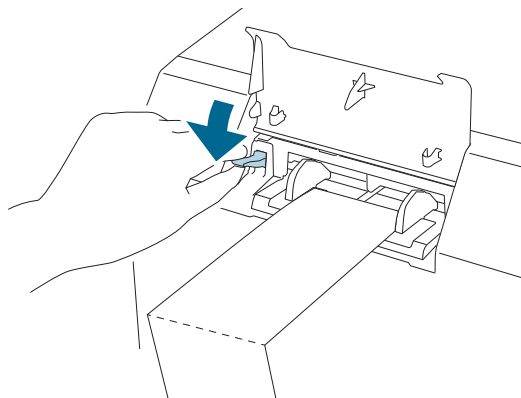

- 16** Insert the leading edge of the paper with the printable side face up.  
When you insert about 100 mm of the paper, the paper is automatically fed further into the printer.

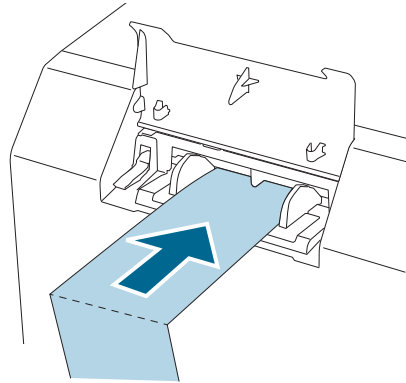

- 17** Close the rear cover.

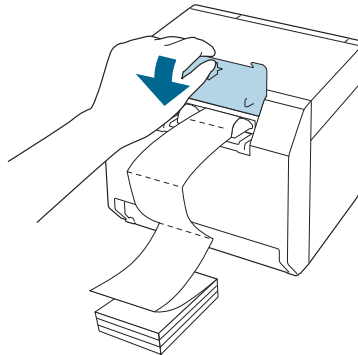

- 18** Press the **||** (Pause) button.  
Check that the printer is ready for printing by checking the home screen.

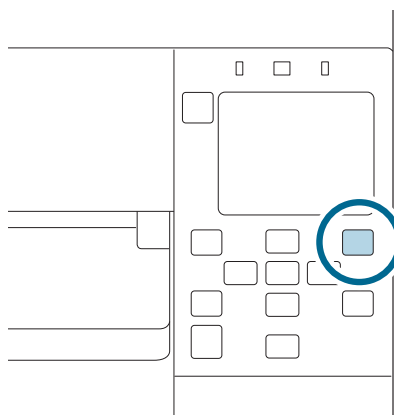

## Adjusting the Shutters

Inside the front cover, there are shutters for adjusting paper suction for during printing.

The shutters need to be correctly opened/closed to match the paper width used. To open/close them, move them with a finger. Furthermore, the paper width can be checked on the label at the top of the main unit.

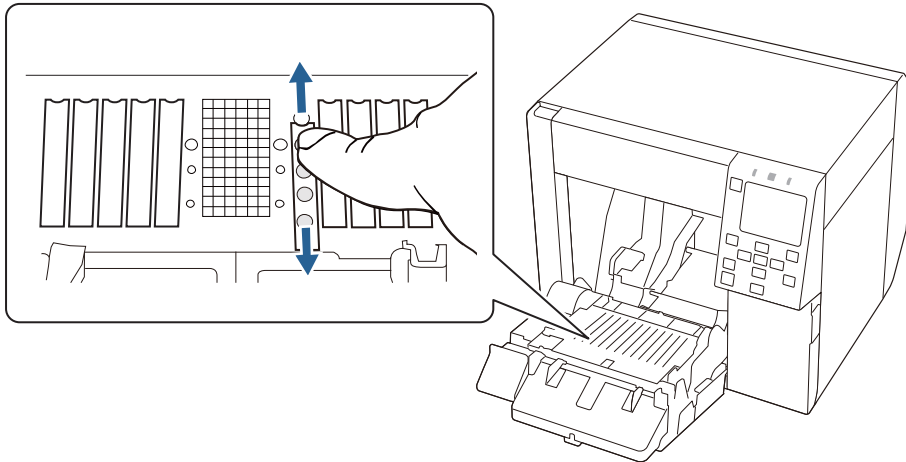

If the shutters are not correctly opened/closed, paper may be jammed or smudged with ink.

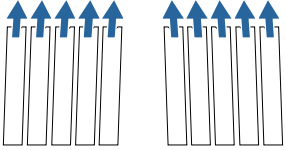
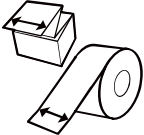
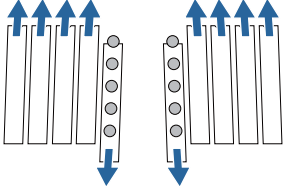
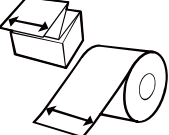
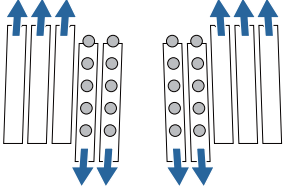
Paper width / Backing paper width	Shutter state
25.4 to 43.8 mm 	Close all the shutters. 
43.9 to 58.4 mm 	Open the innermost shutters. 
58.5 to 73.0 mm 	Open the inner four shutters. 

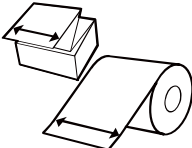
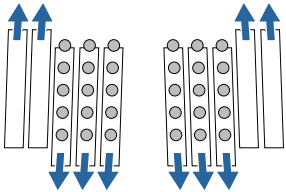
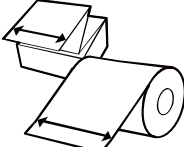
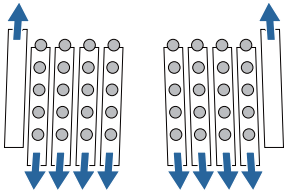
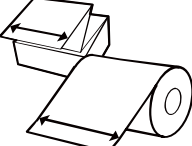
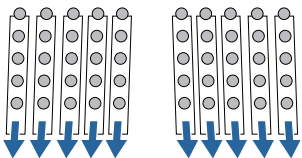
Paper width / Backing paper width	Shutter state
<p data-bbox="236 293 395 315">73.1 to 87.6 mm</p> 	<p data-bbox="855 293 1126 315">Open the inner six shutters.</p> 
<p data-bbox="236 562 411 584">87.7 to 102.2 mm</p> 	<p data-bbox="855 562 1158 584">Open the inner eight shutters.</p> 
<p data-bbox="236 831 432 853">102.3 mm or longer</p> 	<p data-bbox="855 831 1070 853">Open all the shutters.</p> 

## How to Remove Paper

- 1 Check that the printer has been turned on.
- 2 Open the front cover.

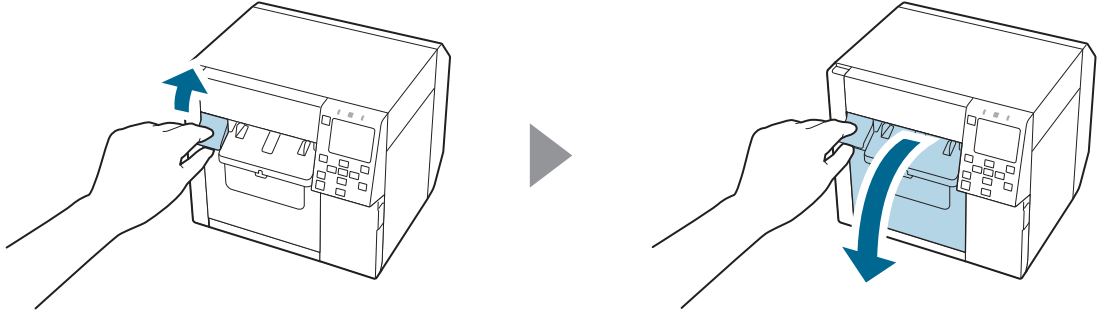

- 3 Remove roll paper or paper core from the printer.

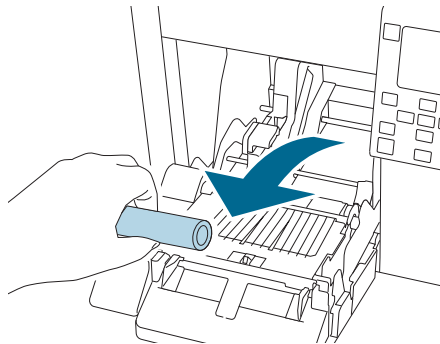

- 4 Close the front cover.

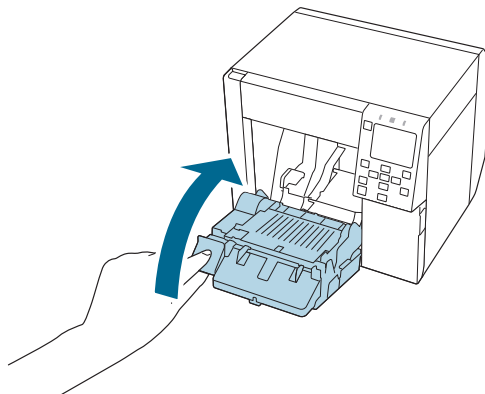



## 5 Press the **||** (Pause) button.

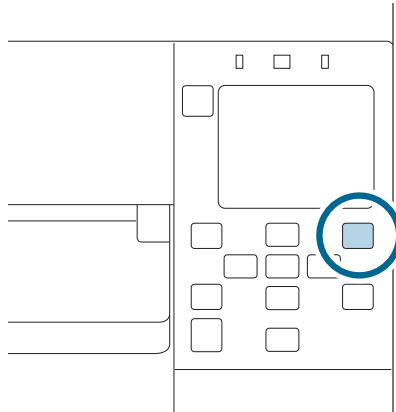

Removing the paper is now completed.

To load paper, see the following pages.

["Loading Roll Paper" on page 67](#), ["Loading Fanfold Paper" on page 73](#)

## Test Print

You can check whether the printer operates normally or not by printing a nozzle check patterns.

Follow the procedure below to print the nozzle check patterns. The nozzle check patterns allow you to check print nozzles for clogging.

- 1** Turn the printer on.
- 2** Select [Menu] and then press the [OK] button.
- 3** Select [Maintenance].
- 4** Select [Print Head Nozzle Check].
- 5** Select [Print].  
The nozzle check patterns are printed.

### 6 Checking the Nozzle Check Patterns

If the pattern is printed normally, all the lines are printed properly as shown in the left figure below. Nozzles are clogging if there are missing lines as shown in the right figure below. Run the print head cleaning.

#### Example of the nozzle check patterns with gloss black ink

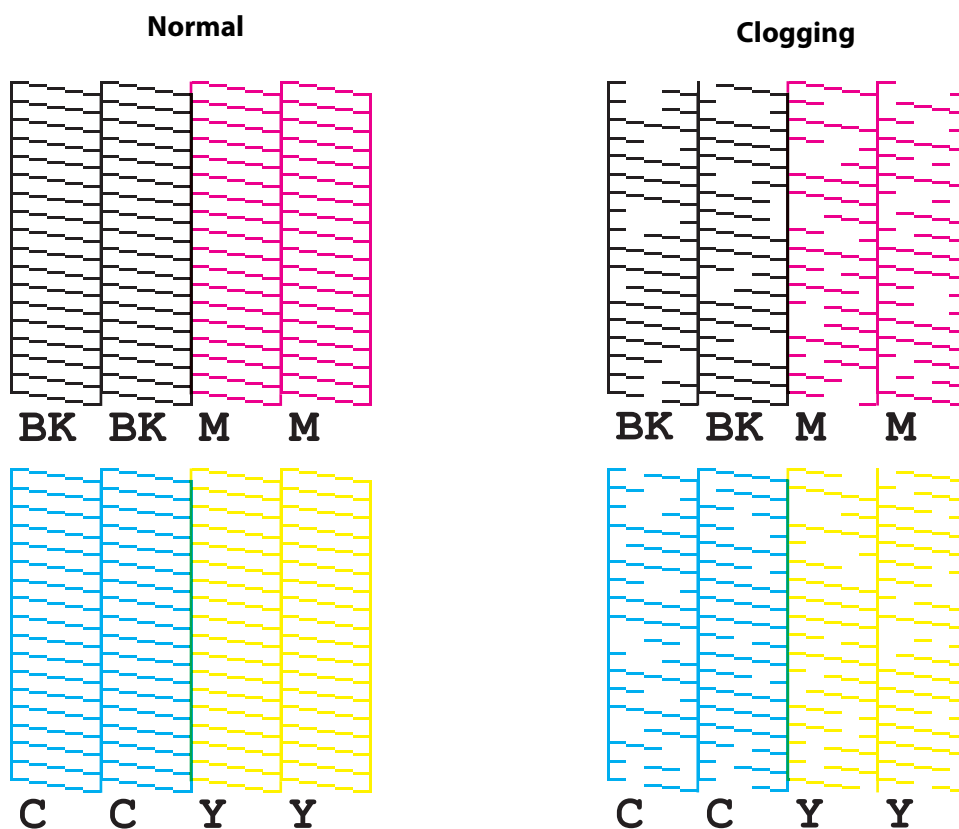

## Self-Test Printing

If you have already installed the printer driver, you can do a test print using the printer driver. Follow the procedure below to do the test print.

- 1 Open [Devices and Printers].
- 2 Right-click the icon of the printer, and then click [Printer properties].
- 3 The Printer properties screen appears. Click [Print Test Page] on the screen.

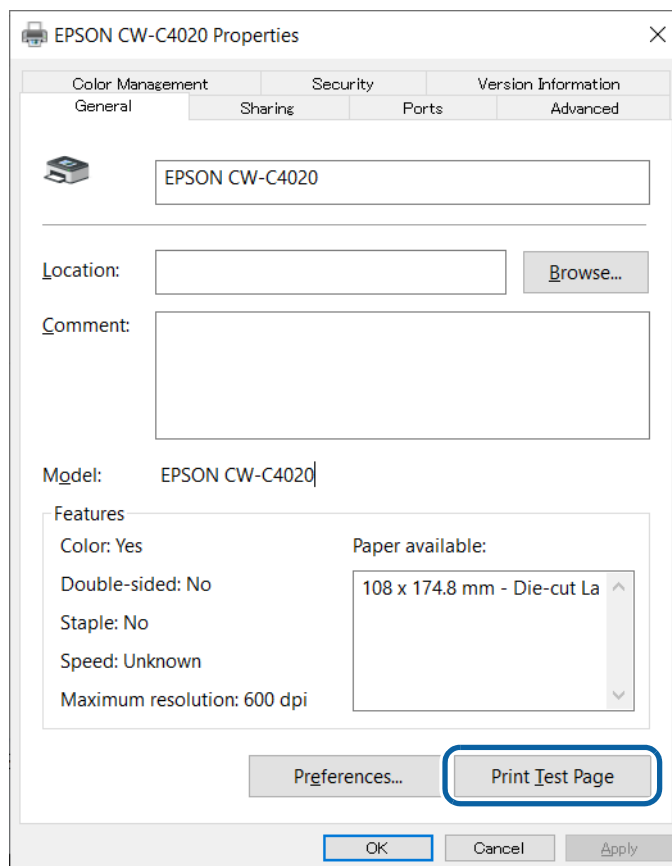

If the [Media Detect] setting has been set to [Gap] or [Black mark], the test page is not printed from the first label. However, you can change to print from the first label if you do the settings described in "[Processing Paper to Avoid Unprinted Labels](#)" on page 278.

# Handling

This chapter provides basic information necessary for handling the printer.

## *Printer Driver for Windows*

This chapter describes how to operate the printer driver for Windows.

The printer driver is software to control the printer in accordance with the print instructions of application software. Setting the print settings in the printer driver screen enables you to obtain the best print results. Furthermore, you can also use the utilities to check the printer status and perform maintenance.

### Printer Driver

The printer driver print settings window is displayed.

**Method 1: Windows Settings > printer management screen > [Print Settings]**

**Method 2: Windows Settings > printer management screen > [Printer Properties] > [General Settings] on the [General] tab**

**Method 3: Windows Settings > printer management screen > [Printer Properties] > [Printing Defaults] on the [Advanced] tab**

**Method 4: Application software print screen > [Printer Properties]**

Any changes made to settings using either Method 1 or Method 2 will be specific to the user that is currently logged in.

Any changes made to settings using Method 3 will be applied to all users who use the printer. However, any settings that have been configured using either Method 1 or Method 2 will be given priority.

Any changes made to settings using Method 4 will be temporary.

If you want a value to be saved as a default setting, use either Method 1 or Method 2 to display and configure the printer driver.

The steps for opening the printer management screen from Windows Settings will vary depending on the version of Windows used.

## Printer Driver Screen Configuration

The printer driver is equipped with a help function. Right-click an item and then click Help to display an explanation on the item.

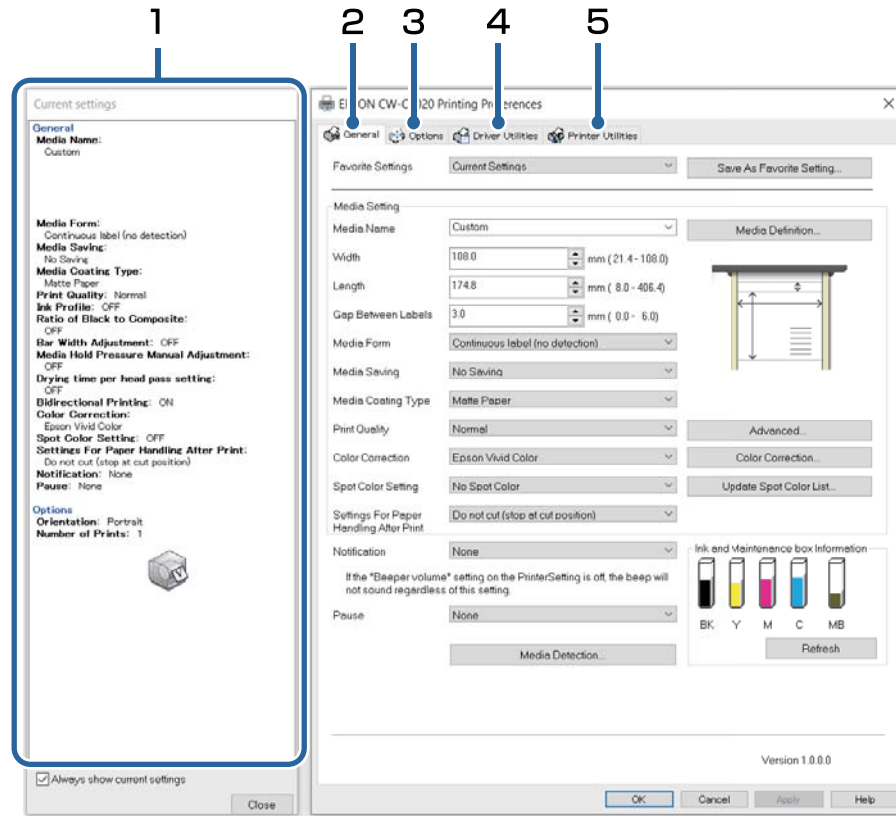

<b>1</b>	<b>Current Settings pane</b> Displays a summary of current settings.
<b>2</b>	<b>General tab</b> Lets you set media (paper) size, media form, and other basic print settings.
<b>3</b>	<b>Options tab</b> Print orientation and the number of copies can be set.
<b>4</b>	<b>Driver Utilities tab</b> Lets you configure various advanced settings.
<b>5</b>	<b>Printer Utilities tab</b> Lets you run printer maintenance functions such as print head cleaning or nozzle check, and start PrinterSetting.

## Media Settings

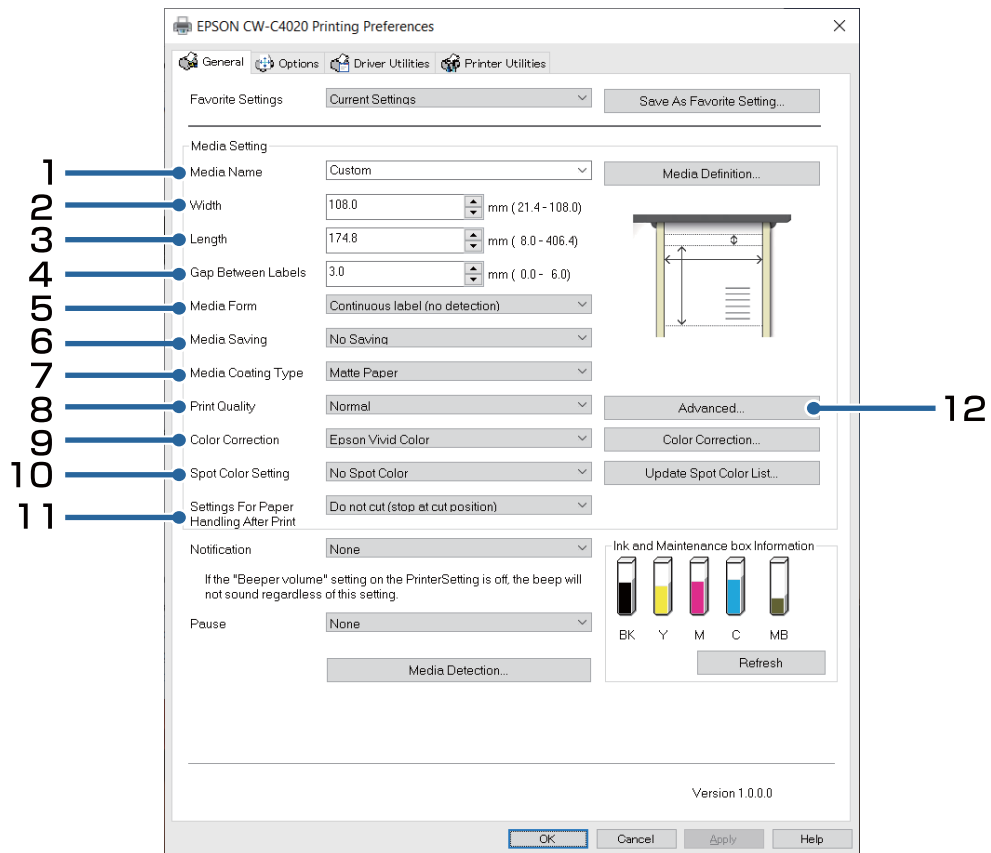

<b>1</b>	<b>Media Name</b>
----------	-------------------

You can select the media settings you created and registered to "Media Definition". You can also directly change the paper settings by selecting [Custom].

**2 Width**

Enter the width.

- Continuous or wristband paper: Paper width

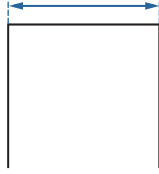

- Full-page label: label width excluding the backing paper

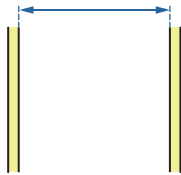

- Die-cut label: Label width excluding backing paper

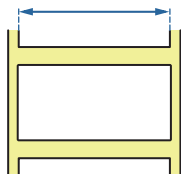
**3 Length**

Enter the length.

- Continuous paper or full-page label: Length of the print range (length of one page)

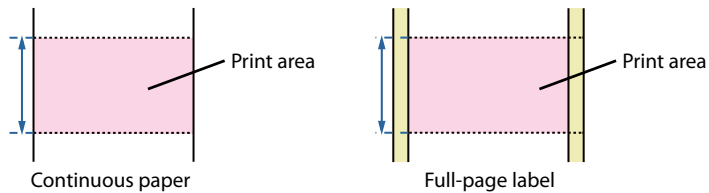

- Die-cut label: Label length excluding backing paper

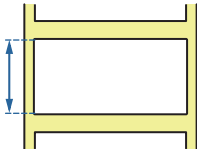
**4 Gap Between Labels**

Enter the gap between labels.

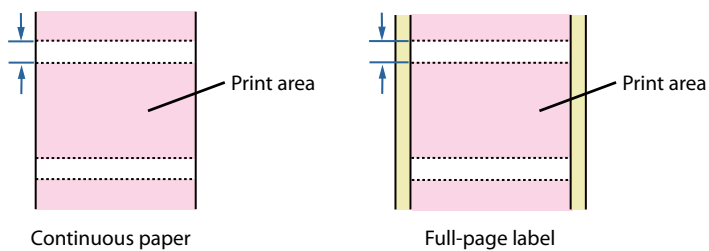

**5 Media Form**

Select the form of the paper.

- Die-cut label
- Full-page label
- Continuous paper
- Wristband paper

**6 Media Saving (for continuous paper/full-page label only)**

Select a media saving setting. The [Media Saving] function eliminates margins from one-page print data to suppress wasting paper.

**IMPORTANT**

If the print data includes barcode font replacement data, the [Media Saving] setting such as [Eliminate Lower Margin] and [Eliminate Lower and Upper Margin] is ignored.



- No Saving: Paper is advanced before and after printing causing top and bottom margins on the printout.
- Eliminate Lower Margin: Paper is not advanced after printing to eliminate bottom margin from the printout.
- Eliminate Lower and Upper Margin: Paper is not advanced before and after printing to eliminate both top and bottom margins from the printout.



If you set the printer to cut paper in the [Settings for Paper Handling After Print] setting, the length of at least 8 mm is required. When the length of print data is less than 8 mm, the margins are not eliminated even if you have set to [Eliminate Lower Margin] or [Eliminate Lower And Upper Margin].



If you want to print at a length that matches the print data, set the length to the maximum and use the [Media Saving] function.

**7 Media Coating Type**

Select the paper type. ("[Paper Specifications](#)" on page 344)



**8 Print Quality**

Select the print quality.

Print resolution when [Media Type] is [Plain Paper] or [Wristband Paper]

- Max Speed: 300 x 600 dpi<sup>\*1</sup>
- Speed: 600 x 600 dpi (initial setting)
- Normal: 600 x 600 dpi
- Quality: 600 x 1200 dpi<sup>\*2</sup>

Print resolution when [Media Type] is [Texture Paper], [Matte Paper] or [Synthetic]

- Max Speed: 300 x 600 dpi<sup>\*1</sup>
- Speed: 600 x 600 dpi
- Normal: 600 x 600 dpi (initial setting)
- Quality: 600 x 1200 dpi<sup>\*2</sup>

Print resolution when [Media Type] is [Glossy Paper], [Glossy Film], or [High Glossy Paper]

- Normal: 600 x 600 dpi
- Quality: 600 x 1200 dpi (Initial setting)<sup>\*2</sup>
- Max Quality: 1200 x 1200 dpi

\*1: The resolution of the print data sent to the printer should be 300 dpi.

\*2: The resolution of the print data sent to the printer should be 600 dpi.

**IMPORTANT**

Supported paper types vary depending on which type of black ink, gloss black or matte black, is installed. See "[Paper Specifications](#)" on page 344.



- When the color correction method is [Epson Preferred Color], the print quality (print resolution) that can be set differs from the above.
- If you change the [Media Type] setting, the [Print Quality] setting will automatically be set to the initial setting suitable for the selected paper type. Click [Advanced] to configure more detailed print quality settings.

**9 Color Correction**

Configure color correction settings. For more details about the color correction, see "[Color Correction](#)" on page 263.

- Epson Vivid Color:  
The color correction engine in the printer corrects the color so that the results are the same as those printed by the CW-C6000/6500 Series. The result will be a vivid color suitable for labels, but will differ from the color displayed on a typical LCD monitor.
- Epson Preferred Color:  
The color correction engine in the printer corrects the color so that the results are the same as those printed by the CW-C3500 Series. The color will be close to the color displayed on a typical LCD monitor.
- ICM:  
The color correction engine in the OS corrects the color according to the ICC profile corresponding to the set paper type and print quality. With the proper ICC profile, the color of the LCD monitor and the printed result can be matched.
- None:  
Select this setting to perform color correction in your application software. No color correction is performed on the printer.



[Epson Preferred Color] allows you to manually customize the color settings in the same way as [Epson Vivid Color], however, there are restrictions on the combination of print quality and paper type. For details, see "[Restrictions when using Epson Preferred Color](#)" on page 265.

**10 Spot Color Setting**

This function allows you to change a specific color to a specified color. For more details about the spot color setting, see "[Spot Color Settings](#)" on page 257.

**11 Settings For Paper Handling After Print**

- Cut (after printing last label)
- Cut (at specified label)
- Cut (after last page of collate page)
- Do not cut (stop at peel position)
- Do not cut (stop at cut position) (Initial setting)
- Do not cut (stop at the print end position)

**IMPORTANT**

If you have set to [Cut (after last page of collate page)] and if the printer stops due to a paper jam or other reason while the auto cutter is operating, it is impossible to resume printing.

**12 Advanced**

Change the settings for color, barcode, and paper handling. For more details about each menu item, see the Help.

- Print Color Adjustment
  - Ink Profile: Print density can be changed to darker or lighter.
  - Ratio of Black to Composite: Adjust the ratio of black ink to composite black.
- Barcode and 2D Symbol Preset
  - Bar Width Adjustment: When using a built-in barcode font, adjust the bar width.
- Paper Adjustment
  - Media Hold Pressure: Adjust the paper suction power of the platen.
  - Drying time per head pass setting: Adjust additional time to dry ink.
- Bidirectional Printing
  - When enabled, printing is performed when the print head moves to the left or right, resulting in faster printing speed.

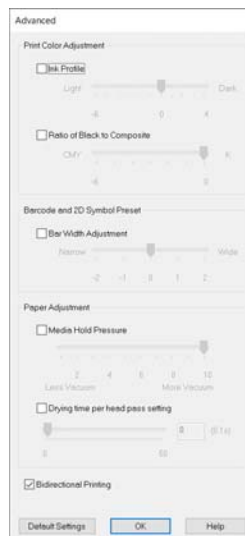

- If you change the settings in [Print Color Adjustment], and/or [Bar Width Adjustment], it may affect readability of barcodes.
- If you increase the ratio of black ink in [Ratio of Black to Composite], be careful not to touch the printed surface immediately after printing because ink can adhere to your fingers.

## Paper Source and Paper Detection Settings

- 1 Open the printer driver window.
- 2 Click [Media Detection...] on the General tab.

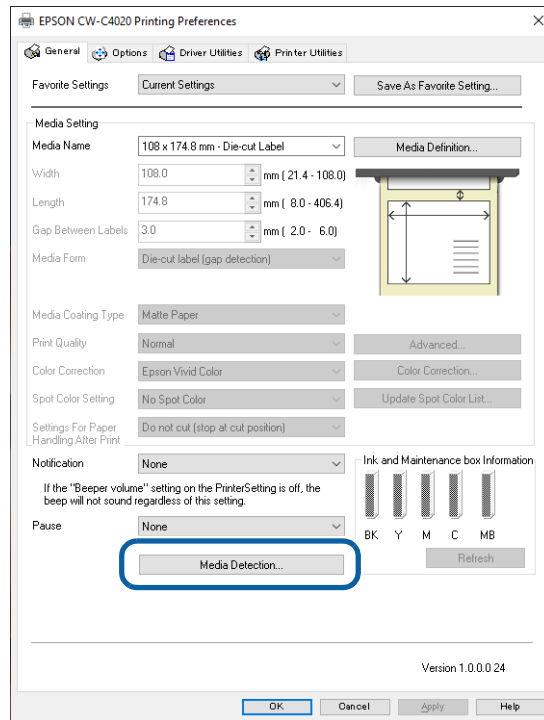

- 3 Make the following settings to match them with the paper you use.

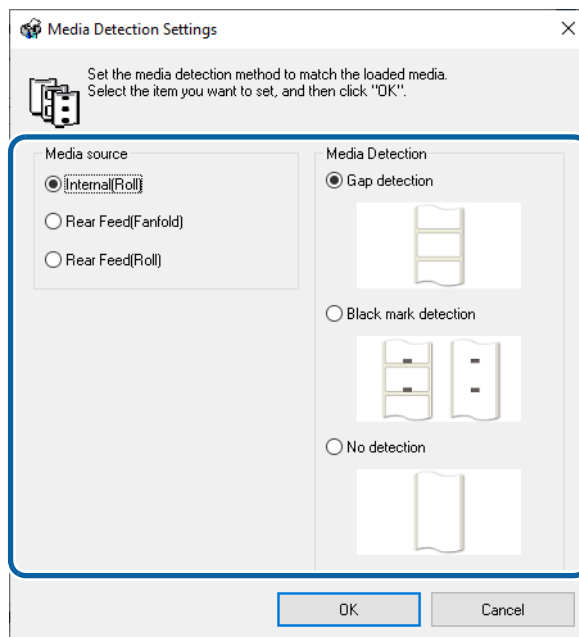

- Media Source: Select how to supply paper to the printer.

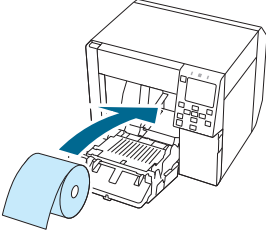
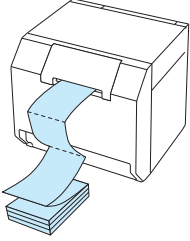
Setting item	Description
Internal roll (roll paper) 	Paper is supplied from inside the printer. Set roll paper attached to the spindle into the printer.
External feed (fanfold paper) External feed (roll paper) 	Paper is supplied from outside the printer. Place roll paper or fanfold paper behind the printer.



If you want to supply roll paper from outside the printer, you need to prepare an external device (paper feeder or paper winder) by yourself. Please contact qualified service personnel for details.

- Media detection: Select how to detect print positions.

Setting item	Description
Gap detection	The print position is detected based on the gaps between labels.
Black mark detection	The print position is detected based on the black marks printed on the back or backing paper of the paper.
No detection	Print position detection using gaps or black marks is not performed.

#### 4 Click [OK].

Paper source and paper detection settings are now complete.

## User-Defined Paper

The size, form, type, and other settings of frequently used paper can be registered to the printer driver as a media definition. This is convenient because you will not need to set the paper settings of the driver when printing from an application if you register a media definition in advance.



If you wish to set the paper size and other settings every time without registering a media definition, select [Custom] from the [Media Name] pull-down menu on the [General] tab. The various settings on the [General] tab will become available so that you can set the paper size and other settings.

## Registering New

Register a new media definition by following the steps below.

- 1 Open the printer driver window.
- 2 Click the [Media Definition] button on the [General] tab.  
The Media Definition screen appears.

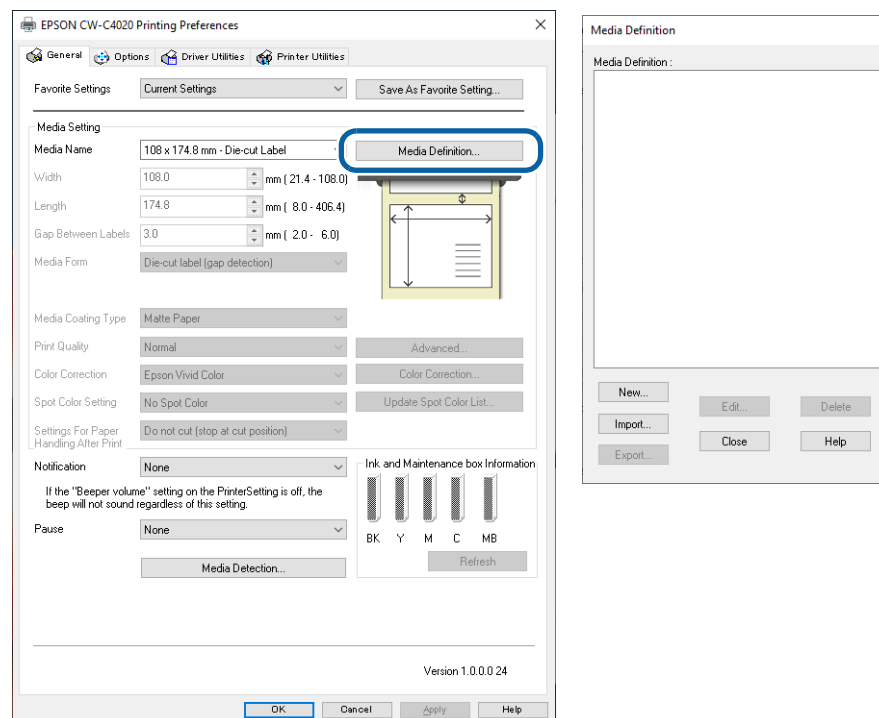

- 3** Click the [New] button.  
The New screen appears.

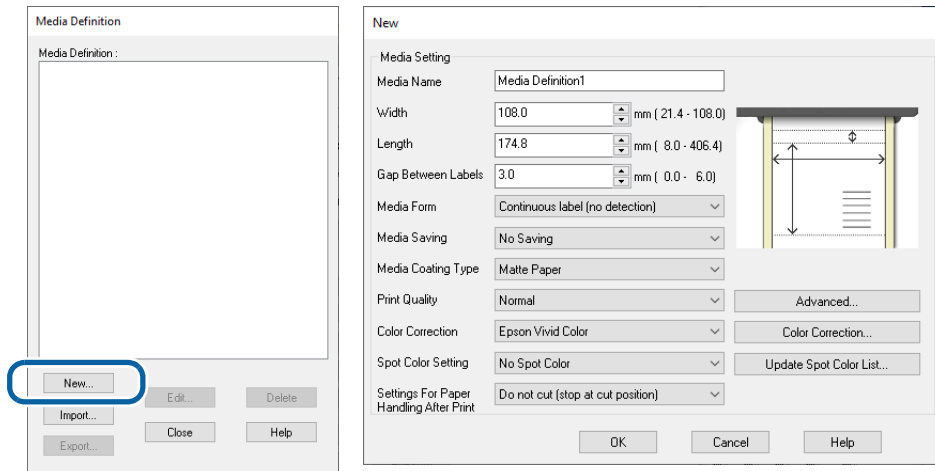

- 4** Enter or change the settings to match them with the paper you use.  
Enter the name of the paper definition in [Media Name]. This is the name displayed when you select a paper size from an application. For explanation for the other settings, see "[Media Settings](#)" on page 86.

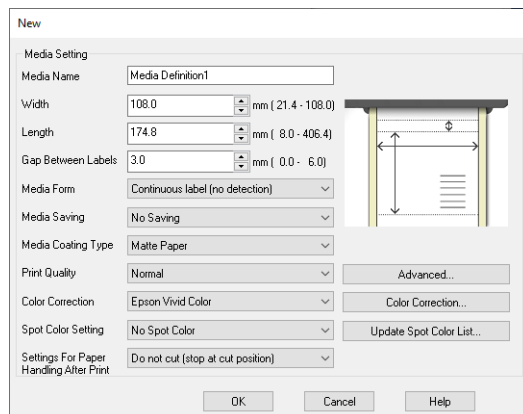

- 5** Click [OK].

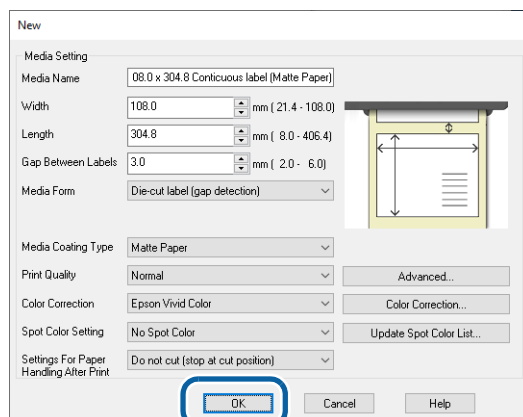

- 6** Check that the registered media name is displayed in the Media Definition screen and then click [Close].

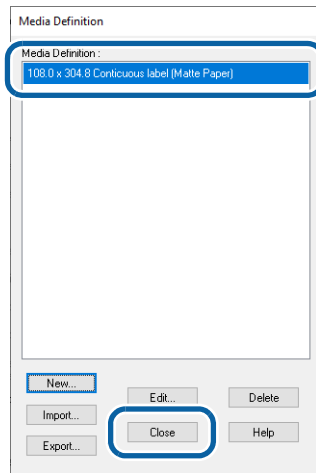

- 7** Check that you can select the registered media name in [Media Name] on the [General] tab.

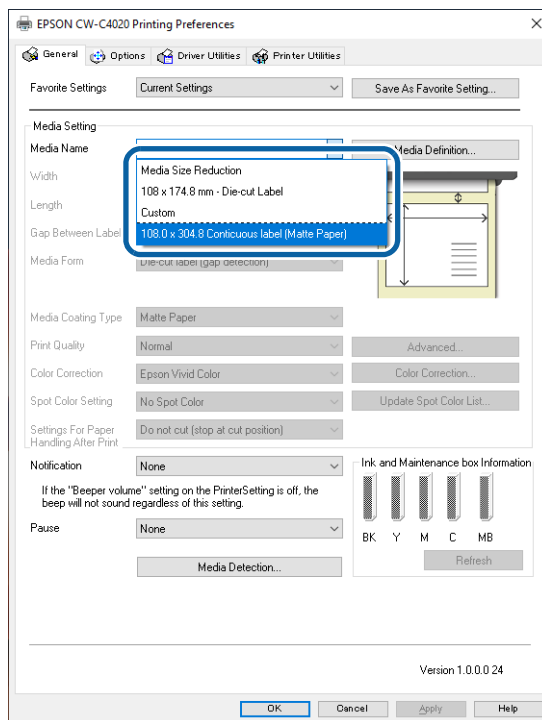

- 8** Click the [OK] button to close the driver.

Paper registration (media definition) is now complete.

## Editing and Deleting

- 1 Open the printer driver window.
- 2 Click the [Media Definition] button on the [General] tab.  
The Media Definition screen appears.

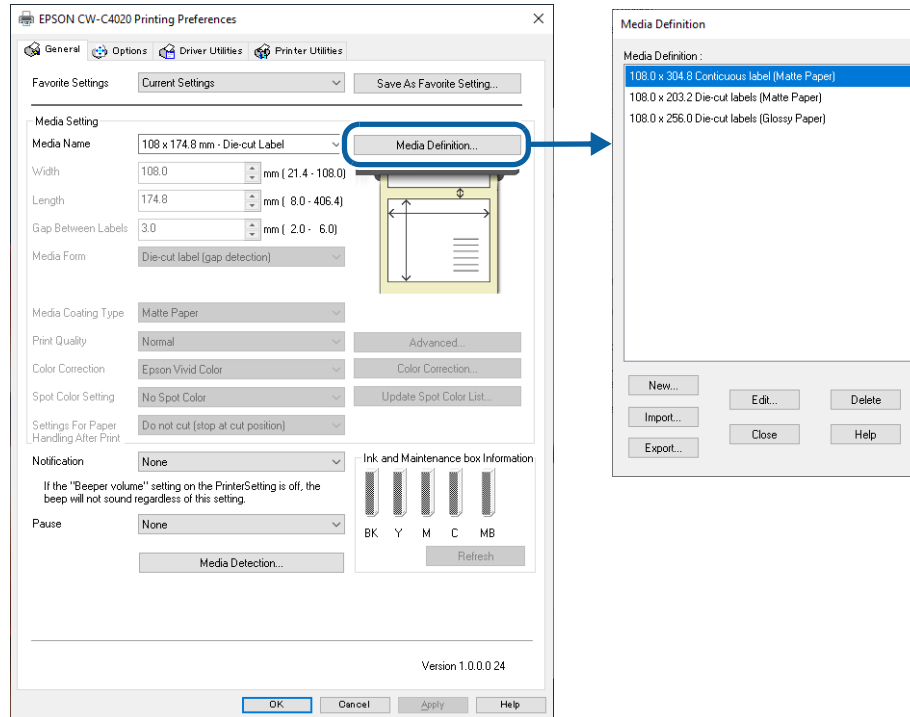

- 3 Click to select the media definition you wish to edit or delete.

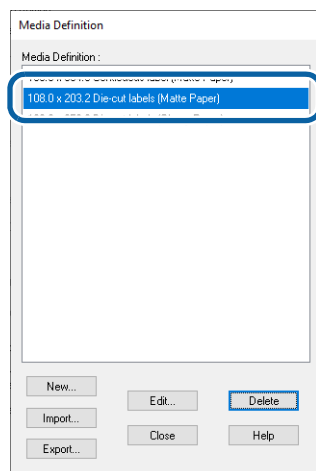



- 4** If you wish to change the definition settings, click the [Edit] button. The Edit screen appears and you can change the definition.

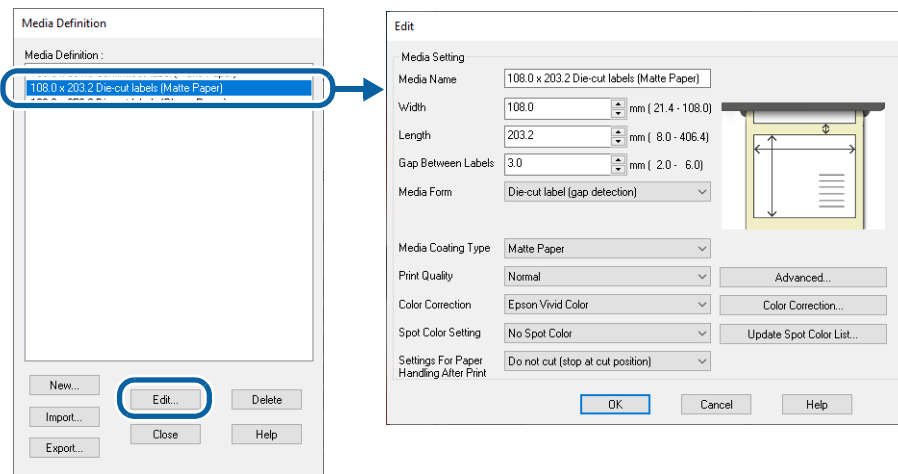

If you wish to delete the definition, click the [Delete] button. A screen appears and if you click the [OK] button, the definition is deleted.

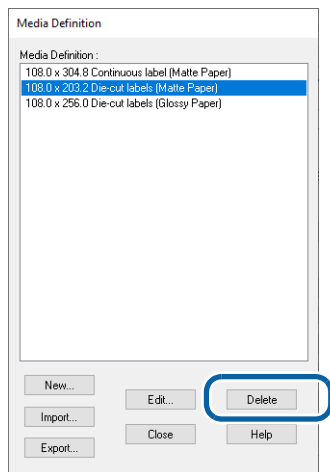

Editing or deleting a media definition is now complete.

## Banner Printing

This product can use the Banner Printing function. Banner Printing divides the specified label length into multiple pages each having a length that is within the maximum label length that the printer can handle (406.4 mm) and prints them with a gap of 0 mm between pages, so that labels longer than 406.4 mm can be printed.



- If you enabled [Shared Print mode] and then performed Banner Printing from a 32-bit Windows client PC, printing may be terminated before it is finished. ("[Sharing the Printer Driver](#)" on page 137)
- This function divides the specified label length into multiple pages each having a length that is within the maximum label length that the printer can handle (406.4 mm) and prints them with a gap of 0 mm between pages. Therefore, the image quality may decrease where pages are connected, and the connections may be noticeable.

## Banner Printing Settings

### 1 In the [General] tab, select the following papers for [Media Form].

- Continuous label
- Continuous paper

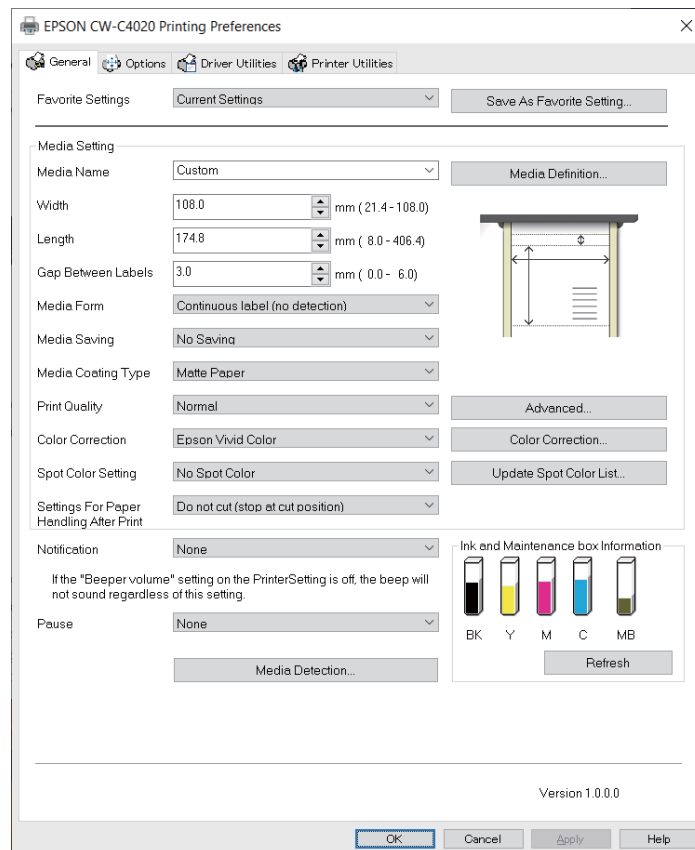

## 2 Select the check box for [Banner Printing] on the [Options] tab.

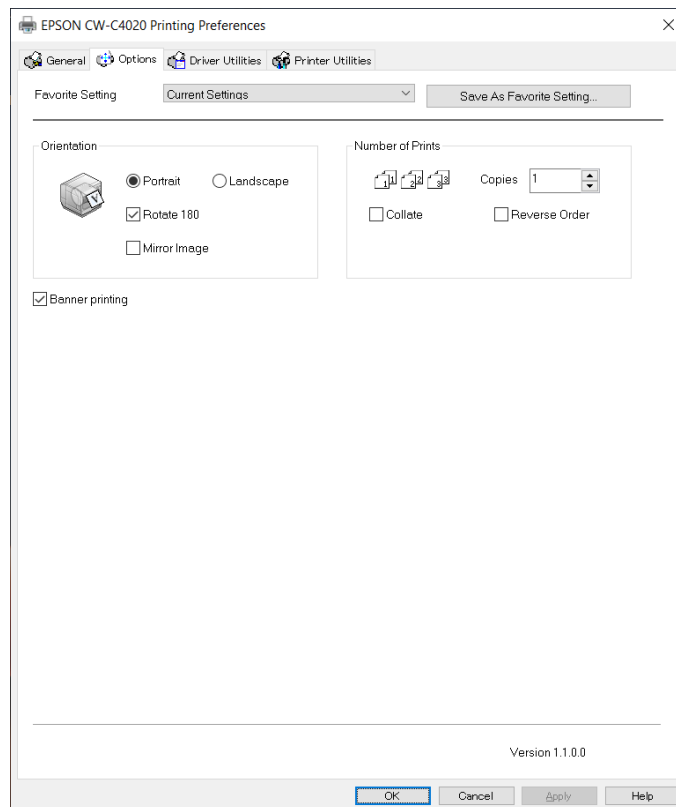

## 3 Check that you can enter up to 3000.0 mm for [Label length] on the [General] tab.

## 4 Enter the length of the label to be printed in [Label length].

## Printing Barcodes

The printer has built-in fonts. This allows you to print a barcode without creating it on an application software.

### Barcode Font Settings

You can make the barcode settings using [Barcode and 2D Symbol Settings] on the [Driver Utilities] tab.

#### 1 Make the following settings.

- Display: Select [Barcodes].
- Font Name: Enter a character string. The string is set as the barcode font name. Only ASCII characters are accepted.
- Type: Select a barcode type. Available setting items changes according to the selected barcode type. You can select the type from the following options.

UPC-A	UPC-E	JAN13(EAN)
JAN8(EAN)	Code39	ITF
Codabar(NW7)	Code93	Code128
GS1-128	GS1 DataBar Omnidirectional	GS1 DataBar Truncated
GS1 DataBar Limited	GS1 DataBar Expanded	

- **Rotation Settings:** Select an option to rotate a barcode.
- **Hexadecimal Input Mode:**  
Select the check box to enter data for a barcode in hexadecimal.
- **Module:** Specify the width of the narrowest element of the barcode in units of dot.
- **Bar Height:** Specify the height of the element in units of dot. Actual print size equivalent to the specified dots will be displayed.
- **HRI Character Position:**  
Specify the position to print HRI characters. Select [Do Not Print] if printing HRI characters is not necessary.



Depending on the selected barcode type, the position option cannot be selected.

- **Composite Component:**  
Select a composite type.
- **Element Ratio:** Specify the ratio of wide element width to the narrowest element width.  
The recommended ratio is 2.5.
- **Check Digit:** A number or symbol added to the barcode number in order to detect an error in the barcode number and to prevent fabrication.
- **Auto Convert to Minimize Entire Symbol Width:**  
You can select this when the barcode type is CODE128. This function minimizes the number of symbols and characters that are necessary to express the specified data string.
- **Start Character:** Specify the start character.
- **Stop Character:** Specify the stop character.

## 2 Click [Add].

The configured barcode font is registered and added to the font list.



- Up to 30 barcode fonts can be registered.
- To edit settings of a registered barcode font, select the font from the font list, change the settings and then click [Save].
- To delete a registered barcode font, select the font from the font list, and then click [Delete].

## Recommended Module Values

Print directions of a barcode are as shown below. The recommended module values vary by paper type, barcode type, and the print direction.

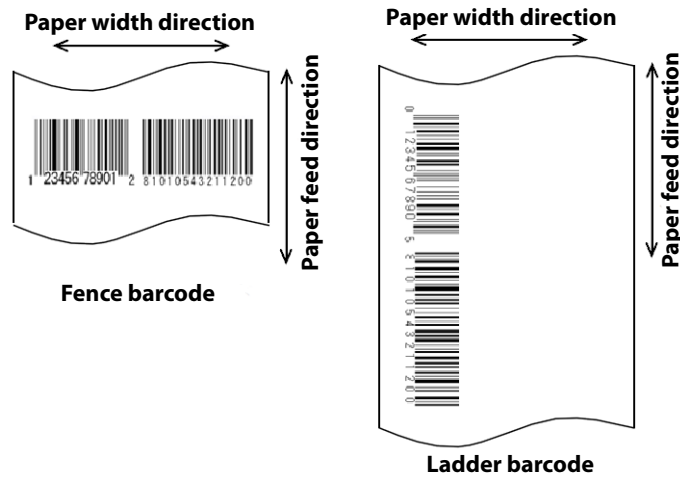

### CAUTION

If [Rotation Settings] is set to [Normal] or [Rotate 270 Degrees], the barcode is not be printed.

- When the minimum module size is in units of 300 dpi [👉 Page 103](#)
- When the minimum module size is in units of 600 dpi [👉 Page 104](#)



- Readability of a barcode varies by paper type, performance of a barcode reader, or other factors. Furthermore, drop in print quality due to clogging of print head nozzles or skew of ink drops can cause a barcode to become unreadable. In case it happens, it is recommended to print HRI characters or take other measures.
- Due to characteristic of ink, ink seeped into paper may cause the bars of a barcode to be printed thicker. In such cases, carry out [Bar Width Adjustment] that reduces the bar width by 2 pixels, and increases space width by 2 pixels.
- If vibrations or shocks are applied to the printer during transporting or installing the printer, it may cause drop in barcode rank. In that happens, barcode rank may improve by carrying out [Bi-directional Printing Adjustment]. ("[Bi-directional Printing Adjustment](#)" on page 211)

## When the minimum module size is in units of 300 dpi

Barcode	Orientation	ANSI Grade D or higher		ANSI Grade C or higher					
		Plain Paper	Wristband Paper	Matte Paper	Synthetic	Texture Paper	Glossy Paper	Glossy Film	High Glossy Paper
Code39	Fence	4	3	3	3	-	3	3	3
	Ladder	5	3	3	3	-	3	3	3
Codabar	Fence	4	3	3	3	-	3	3	3
	Ladder	5	3	3	3	-	3	3	3
Code93	Fence	4	3	3	3	-	3	3	3
	Ladder	5	3	3	3	-	3	3	3
Code128	Fence	4	3	3	3	-	3	3	3
	Ladder	5	3	3	3	-	3	3	3
GS1-128	Fence	4	3	3	3	-	3	3	3
	Ladder	5	3	3	3	-	3	3	3
ITF	Fence	4	3	3	3	-	3	3	3
	Ladder	5	3	3	3	-	3	3	3
GS1 DataBar Omnidirectional	Fence	4	3	3	3	-	3	3	3
	Ladder	5	3	3	3	-	3	3	3
GS1 DataBar Truncated	Fence	4	3	3	3	-	3	3	3
	Ladder	5	3	3	3	-	3	3	3
GS1 DataBar Limited	Fence	4	3	3	3	-	3	3	3
	Ladder	5	3	3	3	-	3	3	3
GS1 DataBar Expanded	Fence	4	3	3	3	-	3	3	3
	Ladder	5	3	3	3	-	3	3	3
UPC-A	Fence	4	3	3	3	-	3	3	3
UPC-E	Ladder	5	3	3	3	-	3	3	3
JAN13	Fence	4	3	3	3	-	3	3	3
JAN8	Ladder	5	3	3	3	-	3	3	3
EAN13	Fence	4	3	3	3	-	3	3	3
EAN8	Ladder	5	3	3	3	-	3	3	3

## When the minimum module size is in units of 600 dpi

Barcode	Orientation	ANSI Grade D or higher		ANSI Grade C or higher					
		Plain Paper	Wristband Paper	Matte Paper	Synthetic	Texture Paper	Glossy Paper	Glossy Film	High Glossy Paper
Code39	Fence	7	7	6	6	-	6	6	6
	Ladder	10	7	6	6	-	6	6	6
Codabar	Fence	7	7	6	6	-	6	6	6
	Ladder	10	7	6	6	-	6	6	6
Code93	Fence	7	7	6	6	-	6	6	6
	Ladder	10	7	6	6	-	6	6	6
Code128	Fence	7	7	6	6	-	6	6	6
	Ladder	10	7	6	6	-	6	6	6
GS1-128	Fence	7	7	6	6	-	6	6	6
	Ladder	10	7	6	6	-	6	6	6
ITF	Fence	7	7	6	6	-	6	6	6
	Ladder	10	7	6	6	-	6	6	6
GS1 DataBar Omnidirectional	Fence	7	7	6	6	-	6	6	6
	Ladder	10	7	6	6	-	6	6	6
GS1 DataBar Truncated	Fence	7	7	6	6	-	6	6	6
	Ladder	10	7	6	6	-	6	6	6
GS1 DataBar Limited	Fence	7	7	6	6	-	6	6	6
	Ladder	10	7	6	6	-	6	6	6
GS1 DataBar Expanded	Fence	7	7	6	6	-	6	6	6
	Ladder	10	7	6	6	-	6	6	6
UPC-A	Fence	7	7	7	7	-	7	7	7
UPC-E	Ladder	10	7	7	7	-	7	7	7
JAN13	Fence	7	7	7	7	-	7	7	7
JAN8	Ladder	10	7	7	7	-	7	7	7
EAN13	Fence	7	7	7	7	-	7	7	7
EAN8	Ladder	10	7	7	7	-	7	7	7



## How to Specify Barcode Data

See the following descriptions to specify barcode data.

About the composite symbol:

Switching between CC-A and CC-B is automatically performed, however, to use CC-C, you need to specify to use it.

(For GS1-128, the type of composite component can be selected from [No composite], [CC-A/CC-B], and [CC-C].)

Composite component type	Encodable number of digits
CC-A	1 to 56 digits
CC-B	1 to 338 digits
CC-C	1 to 2361 digits

About HRI characters:

If the length of the HRI characters becomes wider than entire width of the barcode, the length is regarded as the barcode width.

### UPC-A

- Specify the barcode data with 11 digits. A check digit will be automatically added.

### UPC-E

- Specify the barcode data with 10 digits. 5 digits are for a manufacturer code, and the rest of 5 digits are for a product code.

### JAN13(EAN)

- Specify the barcode data with 12 digits. A check digit will be automatically added.

### JAN8(EAN)

- Specify the barcode data with 7 digits. A check digit will be automatically added.

### Code39

- If both or either one of a start code or a stop code is not specified, they will be automatically added.

### ITF

- If specified with an odd number of digits, "0" (zero) will be automatically added at the beginning of the digits.

### Codabar(NW7)

- Do not include a start code and a stop code. The start code and stop code you specified on the printer driver will be added.

### Code93

- A start code, two check digits, and a stop code will be automatically added.
- A character (□) that indicates a start code is printed at the beginning of the HRI characters.
- A character (□) that indicates a stop code is printed at the end of the HRI characters.
- A combination of ■ and an alphabet character is printed to express each of HRI control characters (00h to 1Fh, 7Fh).

Control character		HRI character	Control character		HRI character	Control character		HRI character
ASCII	Hex number		ASCII	Hex number		ASCII	Hex number	
NULL	00	■ U	VT	0B	■ K	SYN	16	■ V
SOH	01	■ A	FF	0C	■ L	ETB	17	■ W
STX	02	■ B	CR	0D	■ M	CAN	18	■ X
ETX	03	■ C	SO	0E	■ N	EM	19	■ Y
EOT	04	■ D	SI	0F	■ O	SUB	1A	■ Z
ENQ	05	■ E	DLE	10	■ P	ESC	1B	■ A
ACK	06	■ F	DC1	11	■ Q	FS	1C	■ B
BEL	07	■ G	DC2	12	■ R	GS	1D	■ C
BS	08	■ H	DC3	13	■ S	RS	1E	■ D
HT	09	■ I	DC4	14	■ T	US	1F	■ E
LF	0A	■ J	NAK	15	■ U	DEL	7F	■ F

## Code128

- If you have disabled the auto convert function, enter a two-digits start code at the beginning of the data. If you have enabled the auto convert function, the type of start character is automatically determined and you do not need to specify the type in your application.
  - An error will occur if you add {A, which sets the type to CODE A, when CODE A has already been selected as the start character.
  - An error will occur if you add {B, which sets the type to CODE B, when CODE B has already been selected as the start character.
  - An error will occur if you add any one of the following characters when CODE C has already been selected as the start character.  
 {S {C {2 {3 {4 {{
- A special character is expressed by a combination of { and the next character.

Control character	ASCII	HRI character
SHIFT	{S	Not printed
CODE A	{A	Not printed
CODE B	{B	Not printed
CODE C	{C	Not printed
FNC1	{1	Not printed
FNC2	{2	Not printed
FNC3	{3	Not printed
FNC4	{4	Not printed
{'	{{	{ is printed.

**GS1-128**

- ‘()’ are used as delimiters for the application identifiers. (printed as the HRI character, but not encoded.)
- A start code (CODE A, CODE B, CODE C) and a stop code will be automatically added.
- A symbol character FNC1 is automatically added next to the start code.
- If you use “\*”, it will be skipped.
- As an application identifier, specify a two-digits consecutive number. If the identifier is not specified correctly, an error will occur.
- A special character is expressed by a combination of { and the next character.
- If data immediately after { does not apply to any one of the followings, an error will occur.

Control character	ASCII	HRI character
Control character (00h to 1Fh, and 7Fh)		A space is printed.
FNC1	{1	A space is printed.
{	{{	{ is printed.
{(	{{(	( is printed.
{}	{}	) is printed.
{*}	{*}	* is printed.
Beginning parenthesis for an application identifier	(	( is printed.
Closing parenthesis for an application identifier	)	) is printed.
Skipped character	*	Not printed

**GS1 DataBar Omnidirectional / GS1 DataBar Truncated / GS1 DataBar Limited**

- The first “01”, an application identifier, is not encoded (not included as the barcode data).
- When the HRI character is printed, the application identifier 01 is printed as “(01)” before the package identification code.
- You do not need to add a check digit in the barcode data.
- When the HRI character is printed, a check digit will be automatically printed after the product code.
- For GS1 DataBar Limited, specify 0 or 1 for the first digit.

## GS1 DataBar Expanded

- ‘()’ are used as delimiters for the application identifiers. (printed as the HRI character, but not encoded.)
- Be sure to include all the application identifiers in the data.
- If the first data is “01” when an application identifier, left and right parentheses, and \* are excluded, the 14th digit counted from the digit next to “01” is used as the check digit. If the data is incorrect, an error will occur.
- If the number of digits after “01” is less than 14, a check digit is not added.  
(Unlike GS1-128, a symbol “\*” cannot be used for automatic calculation and addition of a check digit. If “\*” is added in the data, it will be ignored and the subsequent data is shifted by one digit.)
- Specify a special character as described below.

Control character	ASCII	HRI character
FNC1	{1	Not printed
Beginning parenthesis for an application identifier	(	( is printed.
Closing parenthesis for an application identifier	)	) is printed.
'*'	{*	Error
Skipped character	*	Not printed
'{'	{{	{ is printed.

---

## How to Print

Open print data file in an application, and specify barcode font, point, and language that you have set on the printer driver, and then print it.



- The barcode size cannot be changed from the point set in [Specified Point]. If you specify a size other than the specified one, the barcode is not printed.
- Some application such as .NET application may not be able to display or let you select the barcode font registered by the printer driver. If that occurs, use the [Font Replacement] function of the printer driver to replace a True Type font with the barcode font. See ["Printing Barcodes / 2D Symbols on .NET Environment" on page 119](#).

## Printing 2D Symbols

The printer driver has the built-in 2D symbol font. This allows you to print a 2D symbol without creating it on an application software.

### Setting the 2D Symbol Font

You can make the 2D symbol settings using [Barcode and 2D Symbol Settings] on the [Driver Utilities] tab.

#### 1 Make the following settings.

- Display: Select [2D Symbols].
- Font Name: Enter a character string. The string is set as the 2D symbol font name. Only ASCII characters are accepted.
- Type: Select a type of 2D symbol. Available setting items changes according to the selected type.
- Rotation Settings: Select an option to rotate a 2D symbol.
- Hexadecimal Input Mode: Select the check box to enter data for a 2D symbol in hexadecimal.

## 2 Make the settings for the barcode type you selected.

- Settings for PDF417
  - \* Module Width: Set module width of PDF417.  
For the recommended value, see ["Recommended Module Values" on page 114.](#)
  - \* Module Height: Specify the ratio of PDF417 module height to the module width.  
For the recommended value, see ["Recommended Module Values" on page 114.](#)
  - \* Column: Specify the number of columns of PDF417.
  - \* Row: Specify the number of rows of PDF417.
  - \* Truncation Symbol: Select the check box to create a symbol using data excluding the stop code of PDF417.
  - \* Error Correction Level: Specify an error correction level for PDF417. This allows the symbol data to be correctly read even if a portion of the symbol is missing or damaged. The larger the number is, the higher the possibility of data restoration gets.
- Settings for MicroPDF417
  - \* Module Width: Set module width of MicroPDF417.  
For the recommended value, see ["Recommended Module Values" on page 114.](#)
  - \* Module Height: Specify the ratio of MicroPDF417 module height to the module width.  
For the recommended value, see ["Recommended Module Values" on page 114.](#)
  - \* Column: Specify the number of columns of MicroPDF417.
  - \* Row: Specify the number of rows of MicroPDF417.
- Settings for QR code
  - \* Model: Select a QR code model.
  - \* Module: Select a width of a cell (module) of QR code.  
For the recommended value, see ["Recommended Module Values" on page 114.](#)
  - \* Error Correction Level: Specify an error correction level for QR code. This allows the symbol data to be correctly read even if a portion of the symbol is missing or damaged. The possibility of data restoration gets higher in the order of L, M, Q, and H.
  - \* Character Mode: Select a mode for data to be converted into a QR code.
- Settings for Micro QR code
  - \* Version: Specify the version of Micro QR code.
  - \* Module: Select a width of a cell (module) of Micro QR code.  
For the recommended value, see ["Recommended Module Values" on page 114.](#)
  - \* Error Correction Level: Specify an error correction level for Micro QR code. This allows the symbol data to be correctly read even if a portion of the symbol is missing or damaged. The possibility of data restoration gets higher in the order of L, M.
- Settings for MaxiCode
  - \* Mode: Select a mode of MaxiCode.
- Settings for GS1 DataBar
  - \* Module: Set module width of GS1 DataBar.  
For the recommended value, see ["Recommended Module Values" on page 114.](#)
  - \* Number of Characters: Specify the max width of GS1 DataBar.  
Set this if you have selected GS1 DataBar Expanded Stacked.



- Settings for AztecCode
  - \* Type: Select a type of AztecCode.
  - \* Cell Size: Select a size of a cell (module) of AztecCode.  
For the recommended value, see "[Recommended Module Values](#)" on page 114.
  - \* Number of Layers: Specify the number of layers of AztecCode.
  - \* Error Correction Area:
    - Select any one of the following error correction area settings for AztecCode. This allows the symbol data to be correctly read even if a portion of the symbol is missing or damaged. The larger the number is, the higher the possibility of data restoration gets.
    - [Auto]: the default is 23%+3 code words.
    - [Specify a Percentage]: Enter a percentage of error correction area into the entry field.
- Settings for DataMatrix
  - \* Symbol Shape: Select a shape of DataMatrix symbol.
  - \* Error Correction Level:
    - Specify an error correction level for DataMatrix.
  - \* Cell Size: Select a size of a cell (module) of DataMatrix.  
For the recommended value, see "[Recommended Module Values](#)" on page 114.
  - \* Number of Vertical Cells:
    - Specify the number of cells of DataMatrix in the vertical direction.
    - Set this when you have selected [Rectangle] in the DataMatrix [Symbol Shape] setting.
  - \* Number of Horizontal Cells:
    - Specify the number of cells of DataMatrix in the horizontal direction.
    - Set this when you have selected [Rectangle] in the DataMatrix [Symbol Shape] setting.
    - [Minimize]: The number of cells is automatically optimized and minimized.
    - [Specify the Size]: The number of cells is set according to the selected size.

### 3 Click [Add].

The configured 2D symbol font is registered and added to the font list.



- Up to 30 2D symbol fonts can be registered.
- To edit settings of a registered 2D symbol font, select the font from the font list, change the settings and then click [Save].
- To delete a registered 2D symbol font, select the font from the font list, and then click [Delete].

## Recommended Module Values

The recommended module values vary by paper type, 2D symbol type, and the print direction.



- You cannot change the orientation of a QR code, Micro QR code, and Maxi code by setting [Orientation] on the [Options] tab to [Landscape].
- You cannot rotate a QR code, Micro QR code, and Maxi code by selecting [Rotate 180] on the [Options] tab. In addition, if [Rotation Settings] is set to [Normal] or [Rotate 270 Degrees], the 2D symbol is not be printed.

### 2D Symbols - Stacked code type

When the minimum module size is in units of 300 dpi

2D Symbols	Orientation	ANSI Grade D or higher		ANSI Grade C or higher					
		Plain Paper	Wristband Paper	Matte Paper	Synthetic	Texture Paper	Glossy Paper	Glossy Film	High Glossy Paper
PDF417	-	5	3	3	3	-	3	3	3
Micro PDF	-	5	3	3	3	-	3	3	3
GS1 DataBar Stacked	-	5	3	3	3	-	3	3	3
GS1 DataBar Stacked Omnidirectional	-	5	3	3	3	-	3	3	3
GS1 DataBar Expanded Stacked	-	5	3	3	3	-	3	3	3

- When the minimum module size is in units of 600 dpi

2D Symbols	Orientation	ANSI Grade D or higher		ANSI Grade C or higher					
		Plain Paper	Wristband Paper	Matte Paper	Synthetic	Texture Paper	Glossy Paper	Glossy Film	High Glossy Paper
PDF417	-	10	6	6	6	-	6	6	6
Micro PDF	-	10	6	6	6	-	6	6	6
GS1 DataBar Stacked	-	10	6	6	6	-	6	6	6
GS1 DataBar Stacked Omnidirectional	-	10	6	6	6	-	6	6	6
GS1 DataBar Expanded Stacked	-	10	6	6	6	-	6	6	6



If vibrations or shocks are applied to the printer during transporting or installing the printer, it may cause drop in barcode rank. In that happens, barcode rank may improve by carrying out [Bi-directional Printing Adjustment]. ("[Bi-directional Printing Adjustment](#)" on page 211)

## 2D Symbols - Matrix code type

□ When the minimum module size is in units of 300 dpi

2D Symbols	Orientation	ANSI Grade D or higher		ANSI Grade C or higher					
		Plain Paper	Wristband Paper	Matte Paper	Synthetic	Texture Paper	Glossy Paper	Glossy Film	High Glossy Paper
QR Code	-	7	5	4	5	-	4	4	4
Micro QR	-	7	6	5	6	-	5	5	5
Aztec	-	7	4	4	4	-	4	4	4
DataMatrix	-	7	4	3	4	-	3	3	3
MaxiCode	-	10	10	10	10	-	10	10	10

□ When the minimum module size is in units of 600 dpi

2D Symbols	Orientation	ANSI Grade D or higher		ANSI Grade C or higher					
		Plain Paper	Wristband Paper	Matte Paper	Synthetic	Texture Paper	Glossy Paper	Glossy Film	High Glossy Paper
QR Code	-	13	10	9	10	-	10	10	10
Micro QR	-	13	12	11	12	-	11	11	11
Aztec	-	13	9	9	9	-	9	9	9
DataMatrix	-	13	8	8	8	-	8	8	8
MaxiCode	-	21	21	21	21	-	21	21	21



If vibrations or shocks are applied to the printer during transporting or installing the printer, it may cause drop in barcode rank. In that happens, barcode rank may improve by carrying out [Bi-directional Printing Adjustment]. ("[Bi-directional Printing Adjustment](#)" on page 211)

## Specifying Data of 2D Symbols

See the following descriptions to specify 2D symbol data.

### PDF417 / MicroPDF417

- If the number of columns and rows is 0, they are automatically calculated.
- When specifying a number other than 0, specify the numbers so that multiplying the columns by the rows equals 928 or lower.

### QR Code

- According to the data size, the version is automatically changed to the version appropriate to the size.

### Micro QR Code

- The size is automatically determined.

### MaxiCode

- Specify a special character as described below.

Control character	Hexadecimal
SHIFT	0x7B, 0x53
CODE B	0x7B, 0x42
CODE C	0x7B, 0x43
FNC1	0x7B, 0x31
FNC2	0x7B, 0x32
FNC3	0x7B, 0x33
FNC4	0x7B, 0x34

### DataMatrix

- If data immediately after { does not apply to any one of the followings, an error will occur.

Control character	ASCII
FNC1	{1
'{'	{{

### GS1 DataBar Stacked / GS1 DataBar Stacked Omnidirectional

- Do not include the application identifier "01" in the beginning of data.
- You do not need to add a check digit in the data.
- Printing the 2D symbol with a composite symbol is supported. When printing the 2D symbol with a composite symbol, use "\|" or "|\" to separate the barcode data from the data for the composite symbol. First enter data for the composite symbol, then enter data for the 2D symbol.

## GS1 DataBar Expanded Stacked

- Multiple GS1 DataBar Expanded barcodes can be stacked. The way to specify the data is the same with that for GS1 DataBar Expanded. For details, see "[GS1 DataBar Expanded](#)" on page 109.
- Printing the 2D symbol with a composite symbol is supported. When printing the 2D symbol with a composite symbol, use “\|” or “|\” to separate the barcode data from the data for the composite symbol. First enter data for the composite symbol, then enter data for the 2D symbol.

## AztecCode

- Both the full range mode and the compact mode are supported.

---

## How to Print

Open print data file in an application, and specify 2D symbol font, point, and language that you have set on the printer driver, and then print it.



- The 2D symbol font size cannot be changed from the point set in [Specified Point]. If you specify a size other than the specified one, the 2D symbol is not printed.
- Some application such as .NET application may not be able to display or let you select the 2D symbol font registered by the printer driver. If that occurs, use the [Font Replacement] function of the printer driver to replace a True Type font with the 2D symbol font. See "[Printing Barcodes / 2D Symbols on .NET Environment](#)" on page 119.

## Printing Barcodes / 2D Symbols on .NET Environment

Since .NET Framework supports only True Type fonts and Open Type fonts, barcode or 2D symbol fonts registered in the printer driver cannot be printed. To solve the problem, use the [Font Replacement] function of the printer driver to replace a True Type font with the barcode or 2D symbol font. Then you can print the barcode or 2D symbol fonts from an application on .NET Framework environment.

On the application, font name of the replaced True Type font is displayed, however, when the data is printed, the barcode or 2D symbol is printed.

### Font Replacement

To set font replacement, open the printer driver, select [Driver Utilities] tab, and then select [Font Replacement].

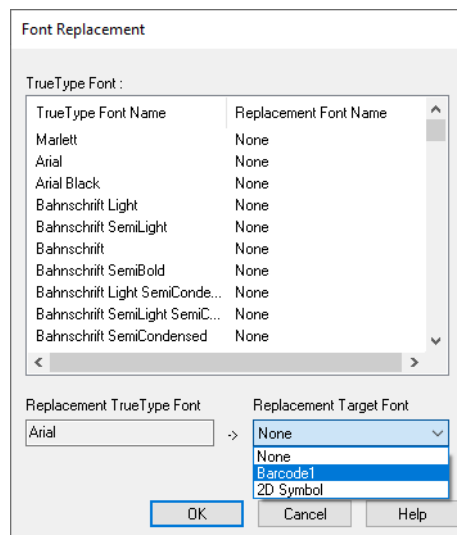

#### 1 Make the following settings.

- Replacement True Type Font
  - \* Select a True Type font you want to substitute.
- Replacement Target Font
  - \* Select a barcode or 2D symbol font you wan to use.

#### 2 Click [OK].

The True Type font is replaced with the barcode or 2D symbol font.

---

## Printing Barcodes/2D Symbols

In the print data file, specify the True Type font that you replaced with the barcode or 2D symbol font, and specify the point and language.



- The point of barcode or 2D symbol is predetermined. Check the point in the [Barcode and 2D Symbol Settings] on the [Driver Utilities] window. If you specify a value other than the specified one, the barcode or 2D symbol is not printed.
- You cannot use the replaced True Type font for data other than barcode or 2D symbol data. If you use the font for other characters, the characters will not be printed. Therefore, make sure to select a True Type font that you do not use for printing data other than barcodes or 2D symbols.



## Favorite Settings

The Favorite Settings function allows you to register and manage print settings of the printer driver.



Note that this function is completely different from the [Favorite Setting] available from the control panel of the printer, and they are not compatible with each other.

The print settings include the settings available on the [General] and [Options] windows. Various settings such as paper type, paper layout, user-defined paper settings are included in the print settings.

[General] window

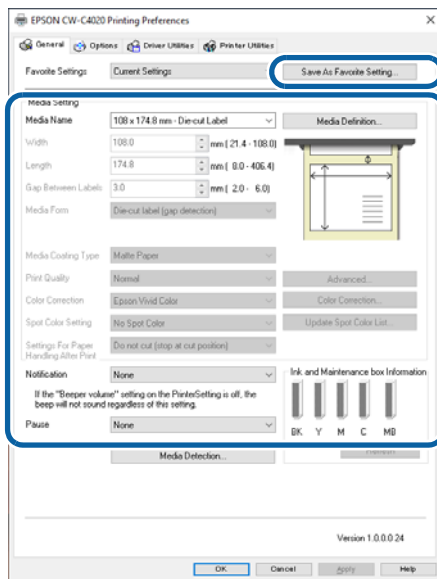

Favorite Settings

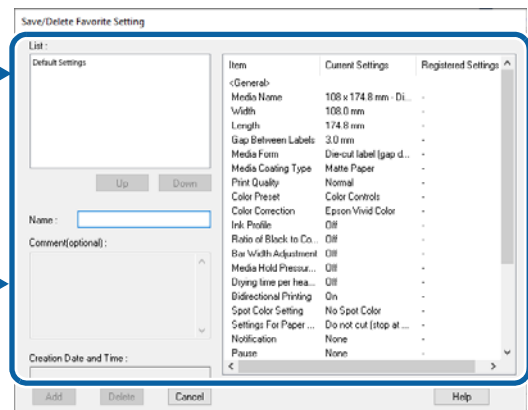

[Options] window

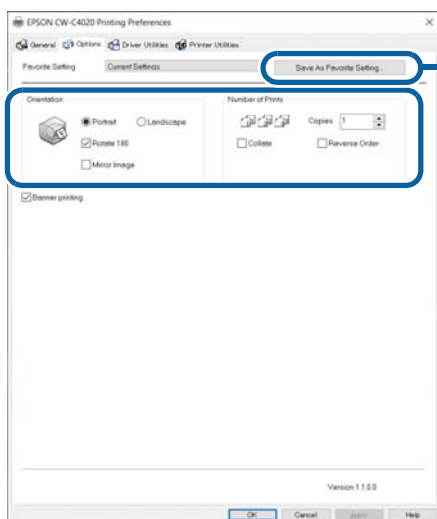

## Features

Many sets of print settings can be registered in [Favorite Settings].

If you frequently use multiple sets of print settings due to use of different sizes or types of paper or other reasons, register each set of the print settings to [Favorite Settings] so that you can complete print settings just by selecting the set from the [Favorite Settings] list. This also allows you to prevent misprint due to wrong print settings.

(If you change paper type or size, you may need to change the [Media Detect] setting of the printer.)

## Registering Print Settings in [Favorite Settings]

### 1 Make the print settings to match them with the paper you use.

Configure the print settings on the [General] and [Options] windows. When using a user-defined paper, select it from the [Media Name] list on the [General] window.

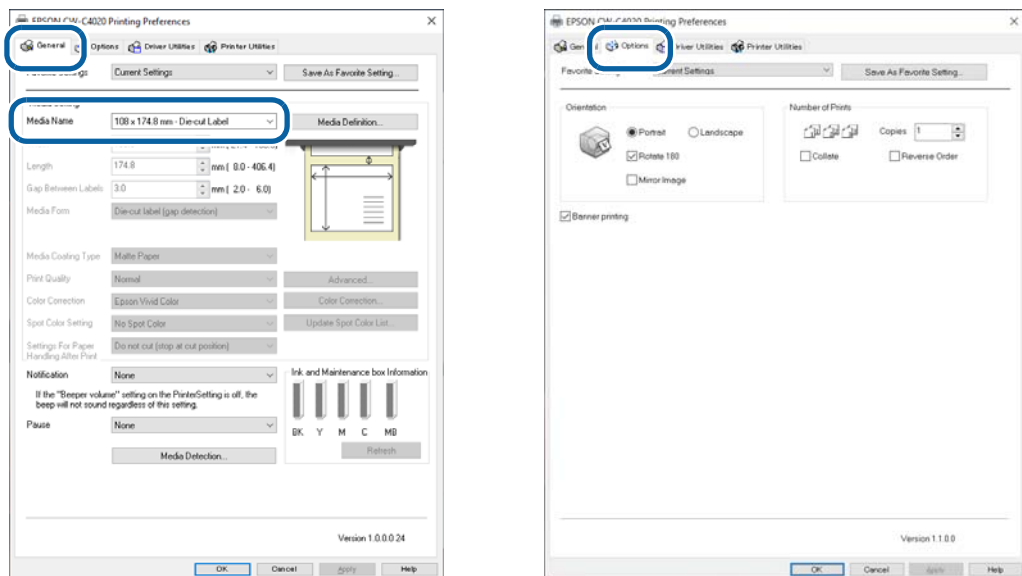

### 2 Click [Save as Favorite Setting]. The Save/Delete Favorite Setting screen appears.

The current settings are displayed on the right side of the screen.

### 3 Enter a name of the settings in the [Name] field, and then click [Add].

The Save/Delete Favorite Setting screen is closed.

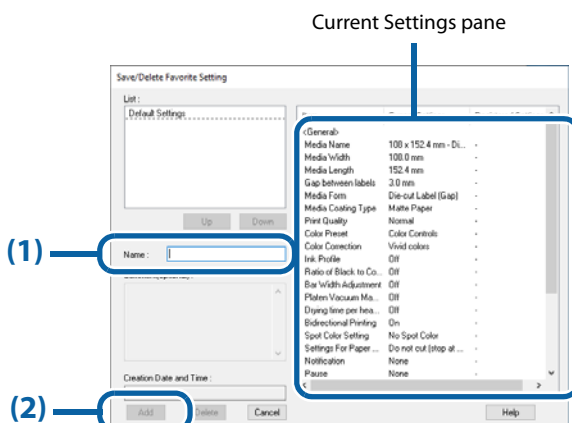

## 4 Check that the name of the added print settings is displayed in the list of [Favorite Settings].

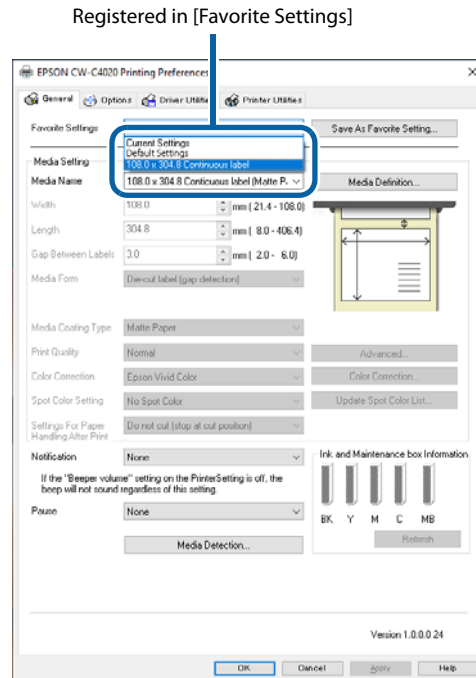

The [Favorite Settings] includes the following settings.

- **Default Settings:** The printer driver has these settings by default.
- **Current Settings:** The settings currently configured on the [General] and [Options] windows. You can check the settings on the [Show Settings] screen and on the [Save/Delete Favorite Setting] screen.
- **Registered Settings:** Print settings registered by the user.

## User Defined Information

The following information is included in User Defined Information.

- User-defined paper settings
- Registered barcode font settings
- Font replacement settings for .NET environment

The user defined information is set on each client computer.

If multiple printer drivers have been installed on one computer, the information can be shared between the multiple printer drivers.

## Exporting/Importing Printer Driver Settings

You can export Favorite Settings, user defined information, and Driver Preferences settings to a BSF file (the extension is .BSF). By importing the exported BSF file, the same settings can be applied to the printer driver on another computer.



- Note that the [Favorite Settings] function on the printer driver is completely different from the [Favorite Setting] function of the printer. It is impossible to include the [Favorite Setting] of the printer in the printer driver settings file.
- In order to avoid problems caused by importing settings from different models, the model name is stored in the BSF file, and the model name is checked during import. Therefore, settings can be exported/imported only with the same model name.

## Exporting Settings File

Export the settings file following the steps below.

### 1 Check that the set of print settings you want to export has been registered in [Favorite Settings].



- If there are multiple entries registered in [Favorite Settings], all entries are exported to the BSF file. When the BSF file is imported, the registered entry at the top of the settings list will be reflected. Edit the order of the registered entries as necessary.

When importing, [Speed] is reflected.

When importing, [Normal] is reflected.

When importing, [Quality] is reflected.

- To change the order in the [Favorite Settings] list, open the Save/Delete Favorite Setting screen, select a set of print settings, and then click [UP] or [Down].

- If no set of print settings has been registered in [Favorite Settings], default print settings of the printer driver are reflected.

## 2 Select the [Driver Utilities] tab. Click [Import/Export Settings].

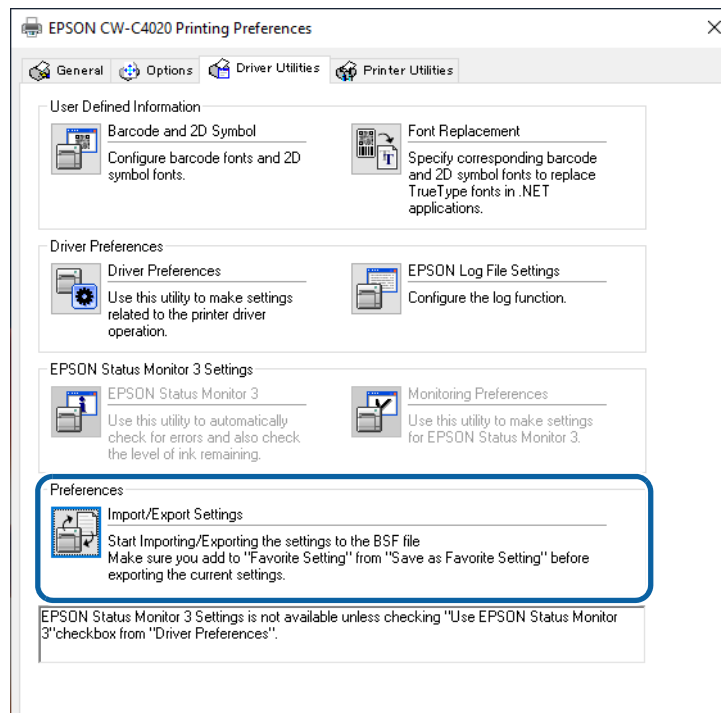

Export in a BSF file from the current settings. If you export it from the general setting, a different content will be exported.

- Current Settings:  
Properties of the printer driver - [General] - [Printing References] - [Driver Utilities] - [Import/Export Settings]
- General setting:  
Properties of the printer driver - [Advanced] - [Printing Defaults] - [Driver Utilities] - [Import/Export Settings]

## 3 The Import/Export Settings window appears. Click [Export Settings].

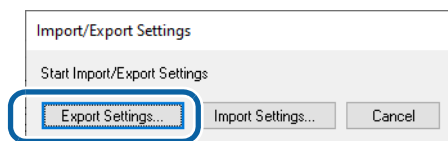

## 4 A window to save the settings file appears. Save the BSF file under a new file name.

## 5 The process completion screen appears. Click [OK].



To the BSF file, a set of print settings registered in [Favorite Settings] is exported. Print settings displayed in the [Current Settings] are not exported.

---

## Importing Settings File



When the BSF file is imported to the printer driver, the printer driver settings are overwritten with the imported settings. If you keep the following settings unchanged, create BSF files to include them.

- List of Favorite Settings
- List of user-defined paper settings
- List of barcode fonts
- List of font replacement for barcode

Import the settings file following the steps below.

- 1** Select the [Driver Utilities] tab. Click [Import/Export Settings].
- 2** The Import/Export Settings window appears. Click [Import Settings].
- 3** A confirmation window appears. Click [OK].
- 4** The window to open a file appears. Select the file to be imported.
- 5** The process completion screen appears. Click [OK].

## 6 Check that the set of print settings you want to export has been registered in [Favorite Settings].



- If there are multiple entries registered in [Favorite Settings], the registered entry at the top of the settings list will be reflected. If the registered entry you wanted is not reflected, modify the order of the settings list and export the BSF file again.

When importing, [Speed] is reflected.

When importing, [Normal] is reflected.

When importing, [Quality] is reflected.

- To change the top position of the [Favorite Settings] list, open the Save/Delete Favorite Setting screen, select a set of print settings, and then click [UP] or [Down].

- If no set of print settings has been registered in [Favorite Settings], default print settings of the printer driver are reflected.
- BSF files are not compatible in the following cases.
  - Between different driver versions
  - Between different builds/versions of Windows
  - Between different architectures of Windows (32-bit/64-bit)



## Starting PrinterSetting from the Printer Driver

Start PrinterSetting from the printer driver following the steps below.



If you start PrinterSetting with this procedure, some settings will not be available. ("[PrinterSetting \(Windows\)](#)" on page 189)

- 1 Open the printer driver window.
- 2 Select the [Printer Utilities] tab. Click [Printer Settings].

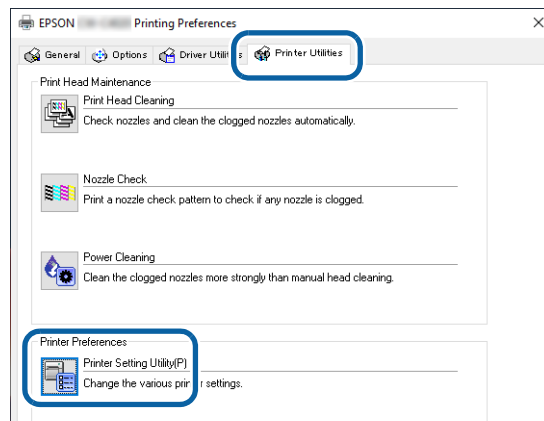

- 3 The CW-C4000 PrinterSetting screen appears.

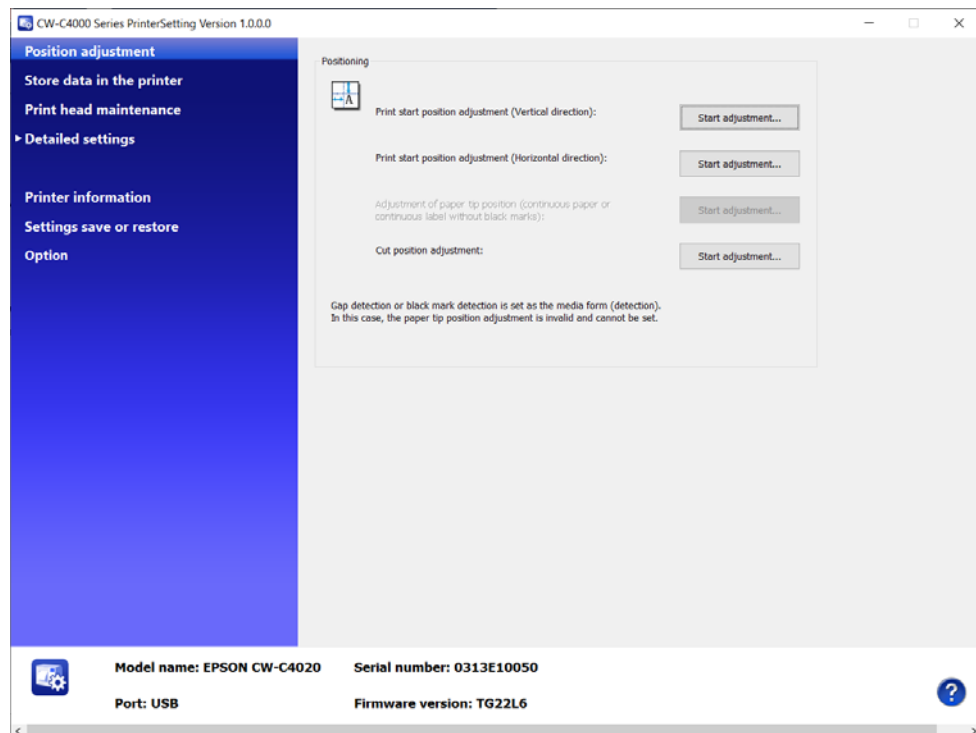

## Speeding Up Printing using High Speed Batch Label Printing Function

The [High speed batch label printing] function allows you to print a large number of labels faster. Before using the function, read and understand "[Restrictions](#)" on page 131.

To get the latest version of the printer driver see "[How to Get Software](#)" on page 365.

### Overview of the Function

When printing labels without using the [High speed batch label printing] function (normal printing), label data is sent one by one to the printer even when printing multiple copies of the same label. Each time one label is printed, the printer needs to conduct operations required between labels such as leaving a space.

When the [High speed batch label printing] function is enabled, the printer driver merges multiple labels so that the total length fits inside 400 mm and sends it to the printer as one data. This reduces time required for operations between labels, so the total time required for printing labels is reduced.

#### Example: When printing 100 copies of 97 mm length label with 3 mm margin between labels

- (1) Normal printing: (Print 1 label + Operation between labels) x 100 times
- (2) High speed batch label printing: (Print 4 labels at a time + Operation between labels) x 25 times

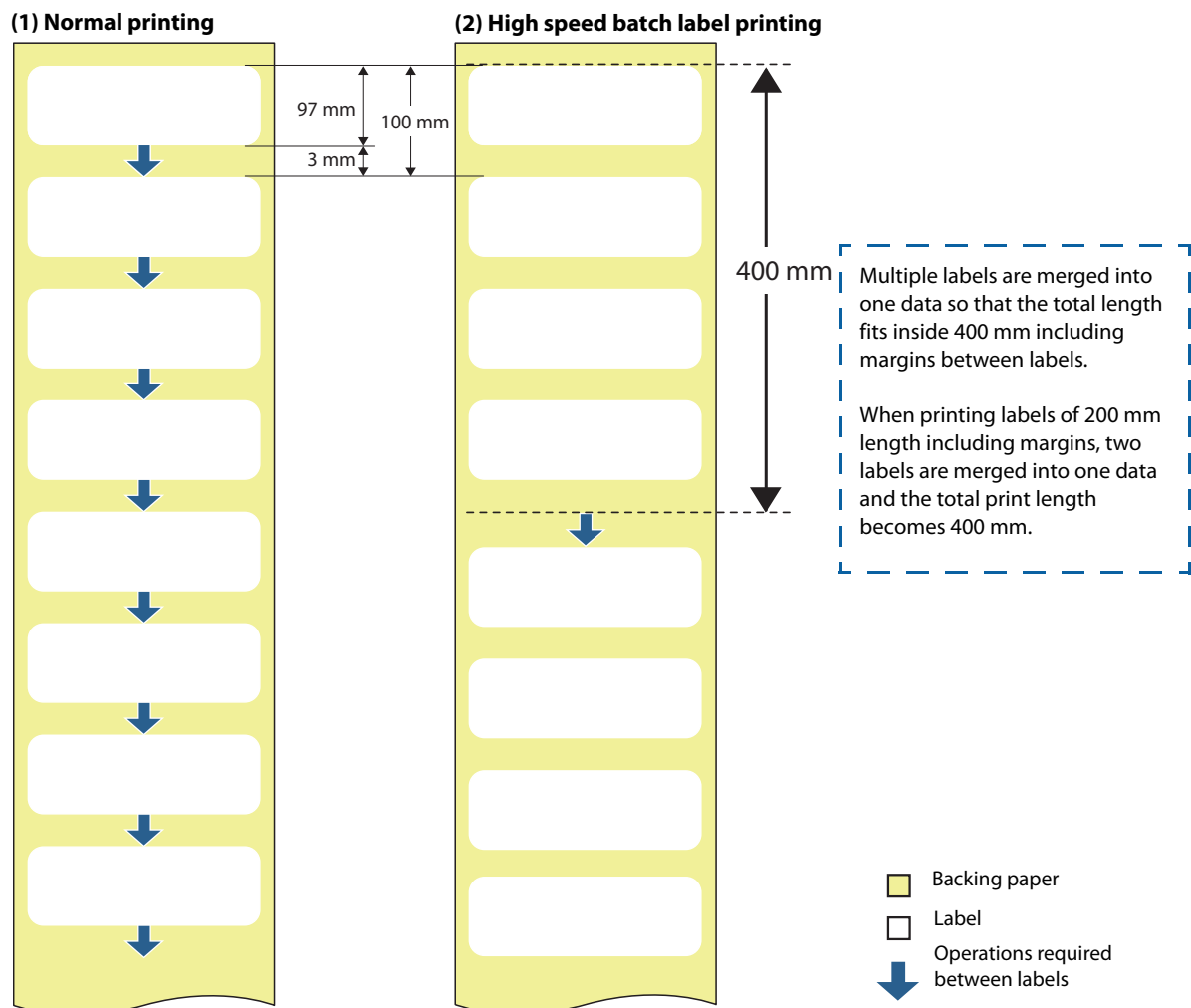

## Restrictions

The following describes restrictions on using [High speed batch label printing].

- Accuracy of print position in the paper feed direction may be lowered.
- You cannot use functions that are designed to operate for each single label on an application.
- Both [Cut] and [Do not cut] options in [Settings For Paper Handling After Print] do not work normally.
- The [Notification] and [Pause] settings do not work normally.
- Since this batch print function merges multiple labels into one data, it takes longer to start printing compared to normal printing, and information related to the number of printed pages cannot be used.
- If a paper jam occurs, you may lose multiple labels at a time. In addition, multiple labels will be printed when the printer recovers from the error.
- Multiple labels merged into up to 400 mm length data is counted as one copy.
- You cannot stop the printer at a position between labels by pressing the Pause button on the printer.
- The number of pages displayed on the panel (e.g., "Printing page 1/1") indicates the number of data pieces compiled, not the actual number of pages printed.

## How to Set

Follow the procedure below to enable [High speed batch label printing].

- 1 Open the printer driver window.
- 2 Click the [Driver Utilities] tab.

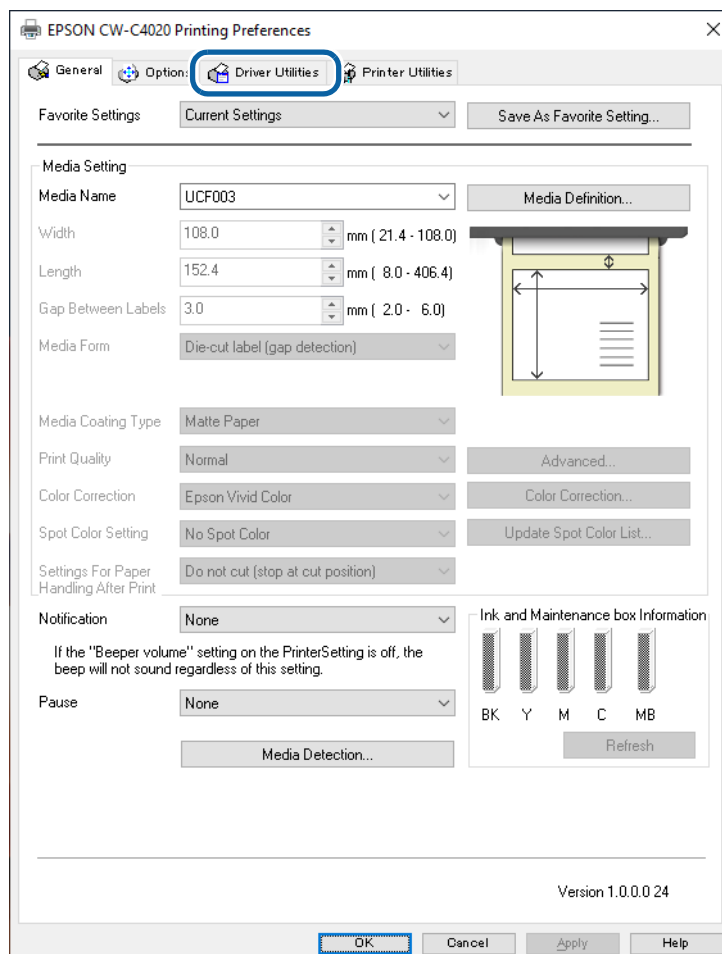

### 3 Click [Driver Preferences].

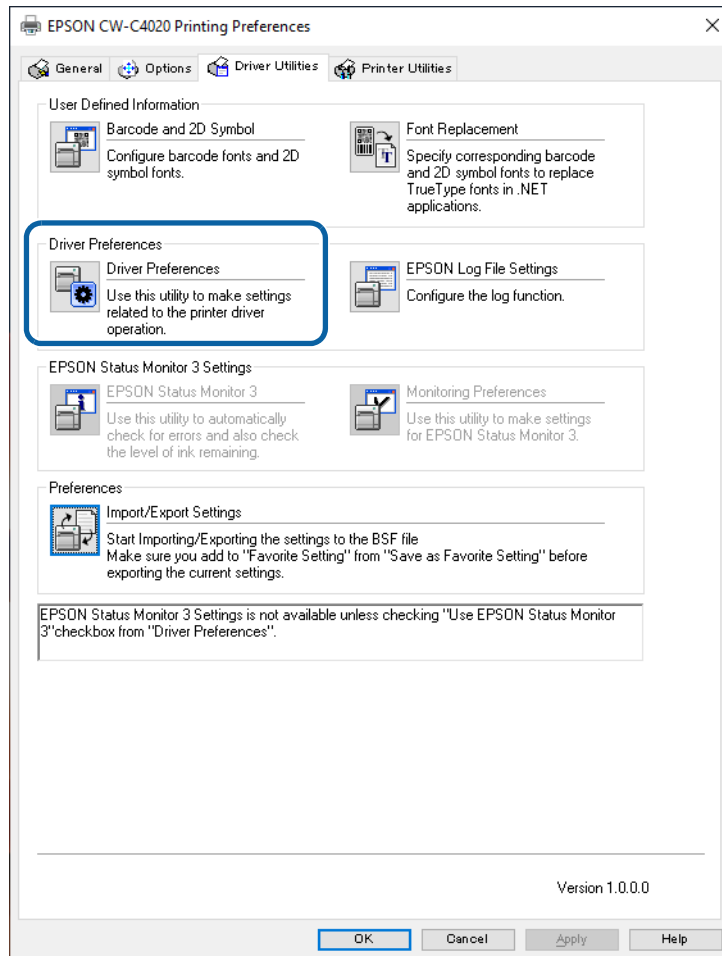

### 4 Select the checkbox for [High speed batch label printing], and then click [OK].

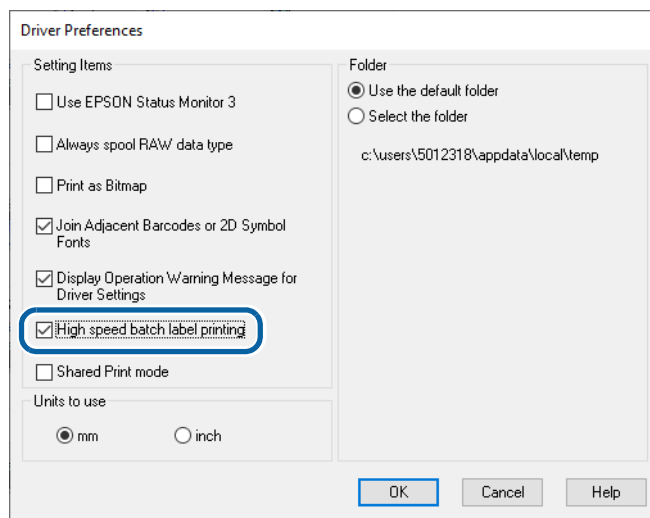

From next time you print labels, multiple labels are automatically merged into up to 400 mm length data and then printed.

## If the Print Position is Shifted

Perform the following procedure and see if you can reduce the print position shifting.

### Executing Media Feed Adjustment

Execute media feed adjustment using PrinterSetting (Windows). ["Start adjustment" on page 196](#)

This can be selected from the operation panel using the following procedure.

[Media Settings] - [Print Position Adjustment]

If the problem is not resolved, carry out the following procedure.

### Checking the Label Position on the Media Used

Check if the virtual label position in the compiled data matches the label position on the media actually used and then revise the driver settings. ["Modifying the Media Size Setting" on page 134](#)

If the problem is not resolved, carry out the following procedure.

### Checking How the Print Start Position Is Shifted

Check if there is regularity in the direction to which the print start position shifts. ["Checking How the Print Start Position is Shifted" on page 135](#)

If there is no regularity, the label position may be unevenly distributed. In this case, the high speed batch label printing function cannot be used. Investigate improving the accuracy of the media you are using.

If there is regularity, carry out the following procedure.

### Checking the Gap Between Labels

Check the position of the label printed at the end of the compiled data and then revise the driver settings. ["Checking the Gap Between Labels" on page 136](#)

## Executing Media Feed Adjustment

If there is a problem with the media feeding, the print start position may be shifted.

Execute media feed adjustment using PrinterSetting (Windows). ["Start adjustment" on page 196](#)

This can be selected from the operation panel using the following procedure.

[Media Settings] - [Print Position Adjustment]

If the shift of the print position does not improve after performing the media feed adjustment, perform the following procedure. ["Modifying the Media Size Setting" on page 134](#)

## Modifying the Media Size Setting

The length (l) and gap between labels (g) set in the driver will be used repeatedly when compiling the data. Therefore, measuring multiple label positions that are actually used and setting the average value in the driver may improve the print position.

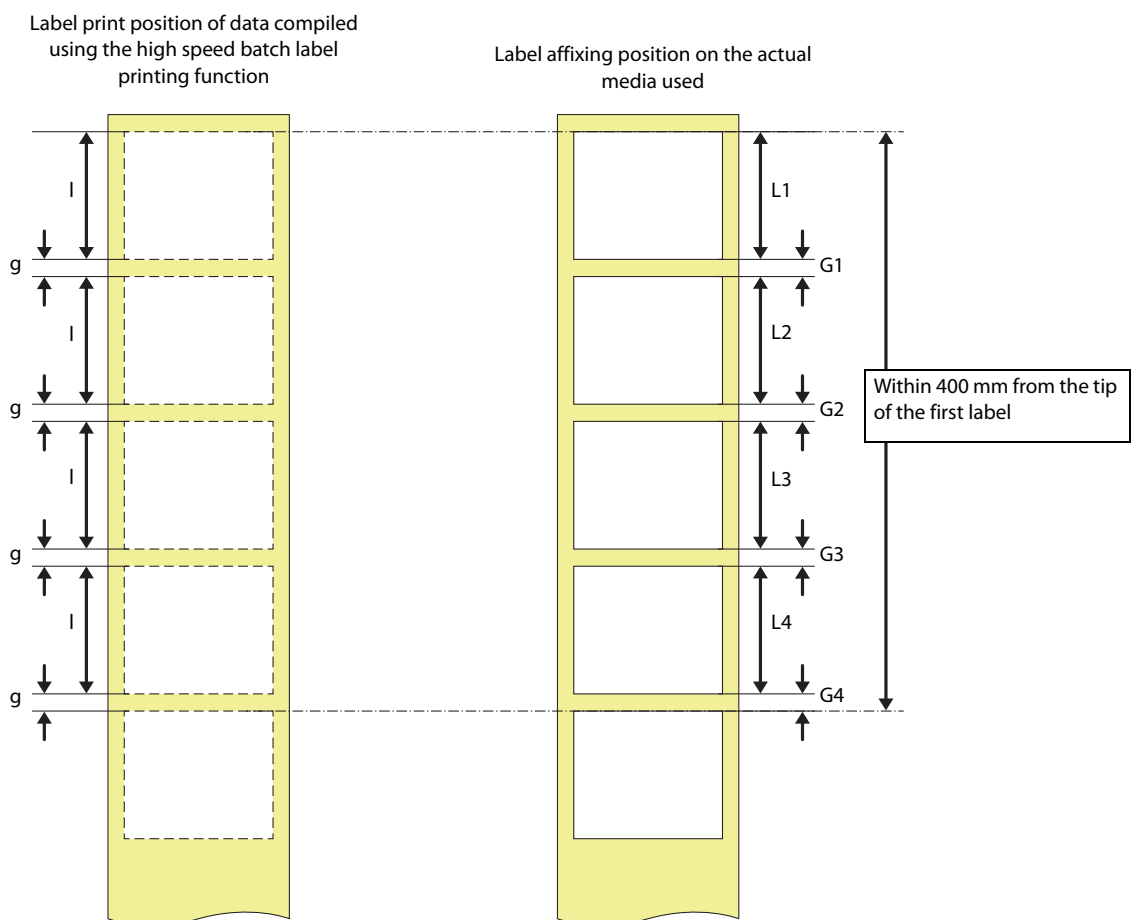
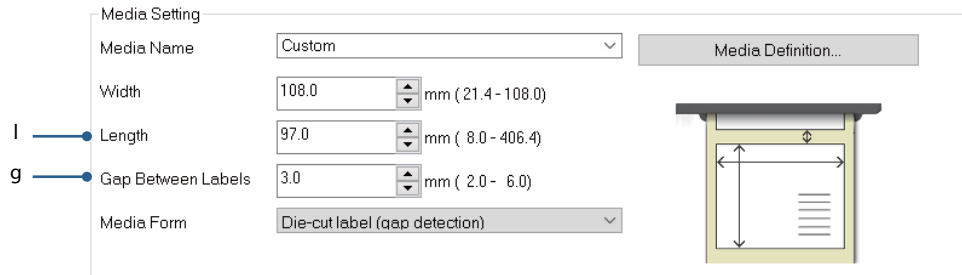

Check it following the procedure below.

- 1** Measure the label length of the actual media used [e.g.: L1, L2, L3, L4] and gap between labels [e.g.: G1, G2, G3, G4]. This applies to cases where the distance from the tip of the first label is up to 400 mm.
- 2** Calculate the average measured label length [e.g.:  $L = (L1 + L2 + L3 + L4) / 4$ ] and the average gap between labels [e.g.:  $G = (G1 + G2 + G3 + G4) / 4$ ].
- 3** Check if the calculated average label length L of the actual media and the label length l of the printer driver match.  
If they do not match, enter the length L for the label length in the driver.

#### 4 Check if the calculated average gap between labels G of the actual media and the gap between labels g of the printer driver match.

If they do not match, enter the gap G for the gap between labels in the driver.

If the shift of the print start position does not improve after performing the above procedure, perform the following procedure. ["Checking How the Print Start Position is Shifted"](#) on page 135

#### Checking How the Print Start Position is Shifted

If there is a regularity in the shift of the print start position, such as when the shift increases by 1 mm per label, perform the following procedure. ["Checking the Gap Between Labels"](#) on page 136

If there is no regularity, the label position may be unevenly distributed. In this case, the high speed batch label printing function cannot be used. Investigate improving the accuracy of the media you are using.

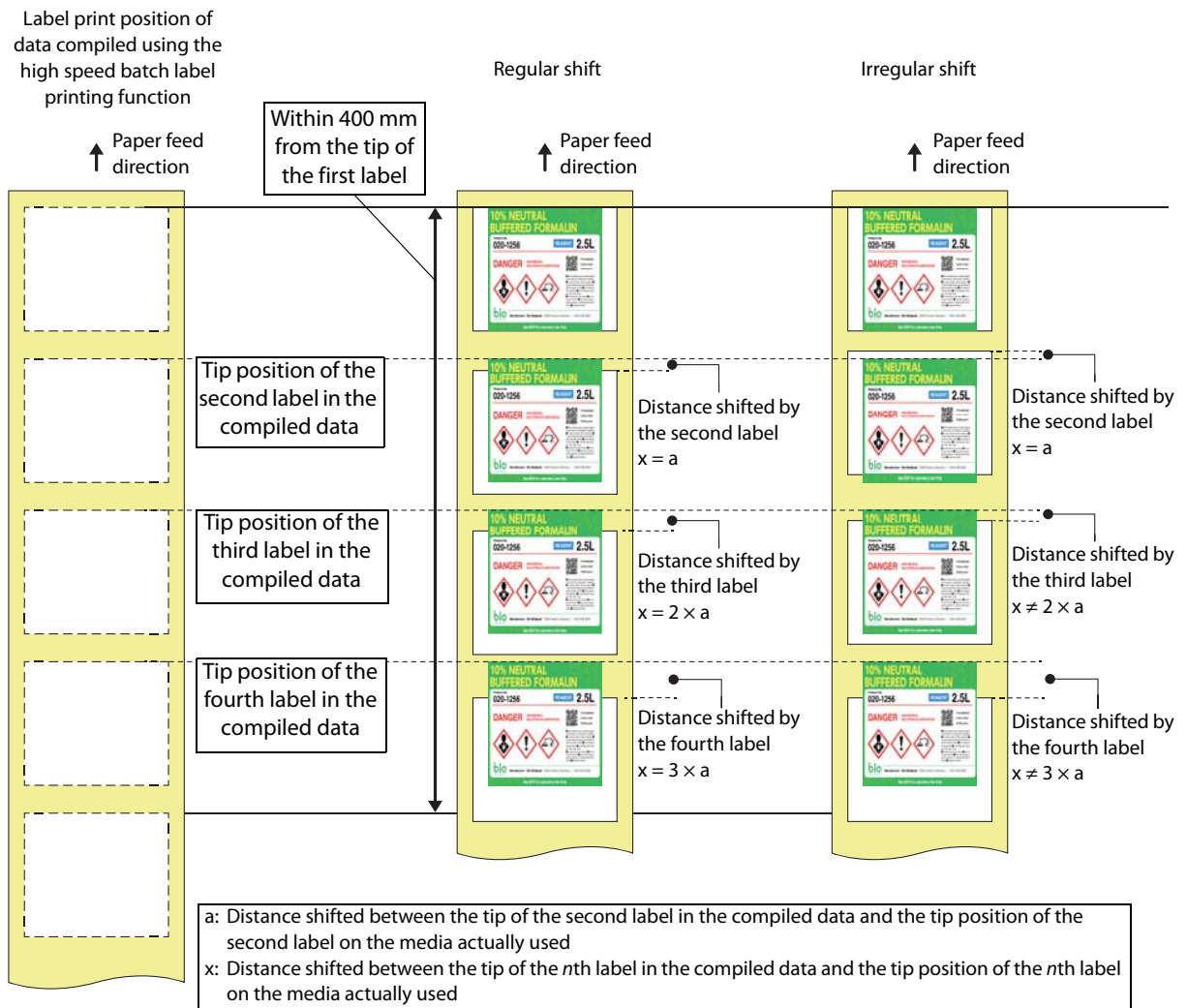

### Checking the Gap Between Labels

Measure the shifted distance between the tip of the last label printed from the compiled data and the actual print start position.

Calculate how many millimeters each label is shifted. You can check this by using: the distance the labels have shifted / (the number of labels connected - 1).

For example, if four labels are connected in one piece of data, and the fourth label is shifted by 0.6 mm, you can adjust the gap between labels by 0.2 mm to eliminate the shift in all four labels.

$$0.6 \text{ mm} / (4 \text{ labels} - 1) = 0.2 \text{ mm}$$

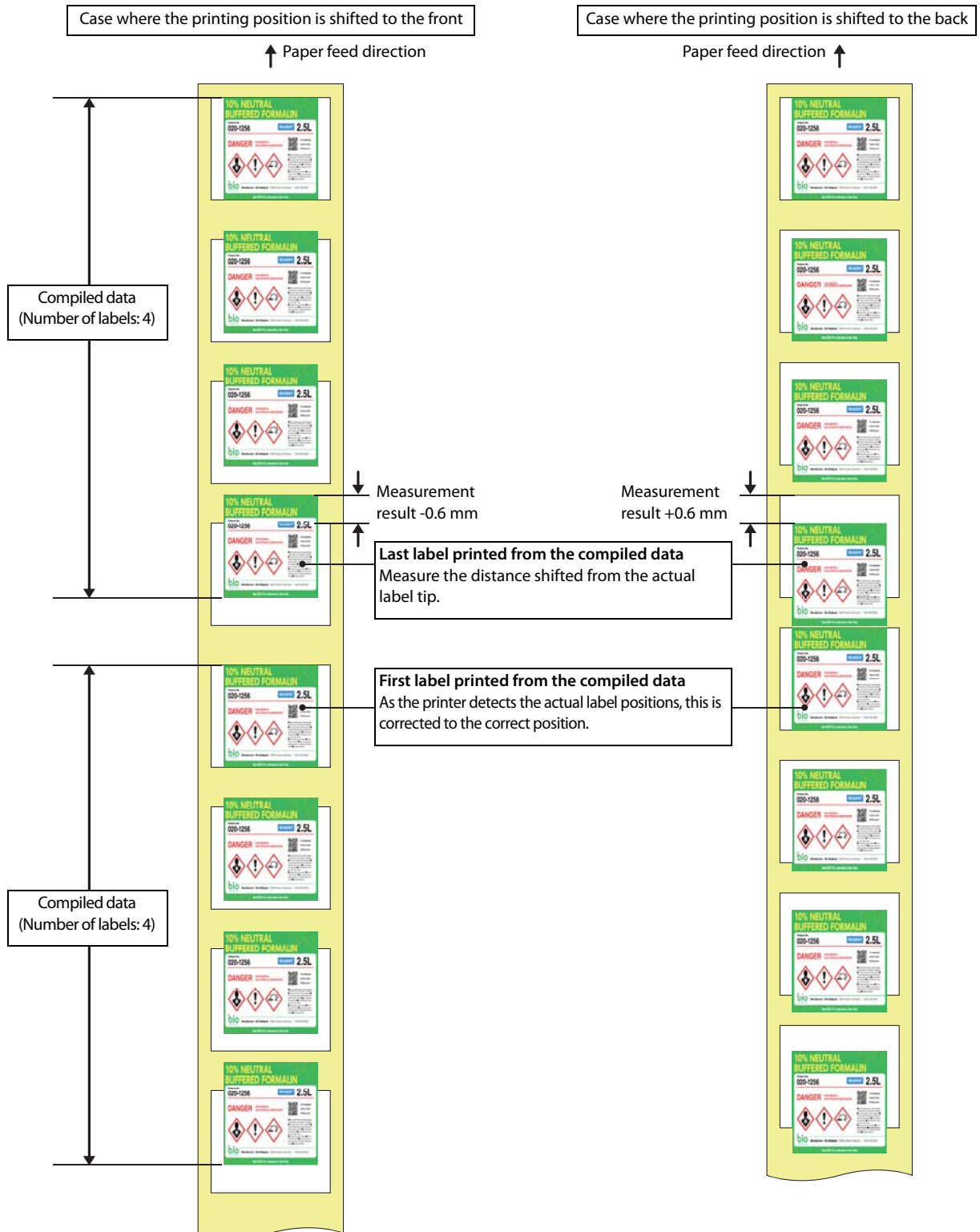



## Sharing the Printer Driver

The printer driver installed on a server can be shared and used by multiple client computers. Since the clients can use the printer driver settings made on the server, various printing settings can be shared easily. This saves you the trouble of installing and setting the printer driver on each client computer.

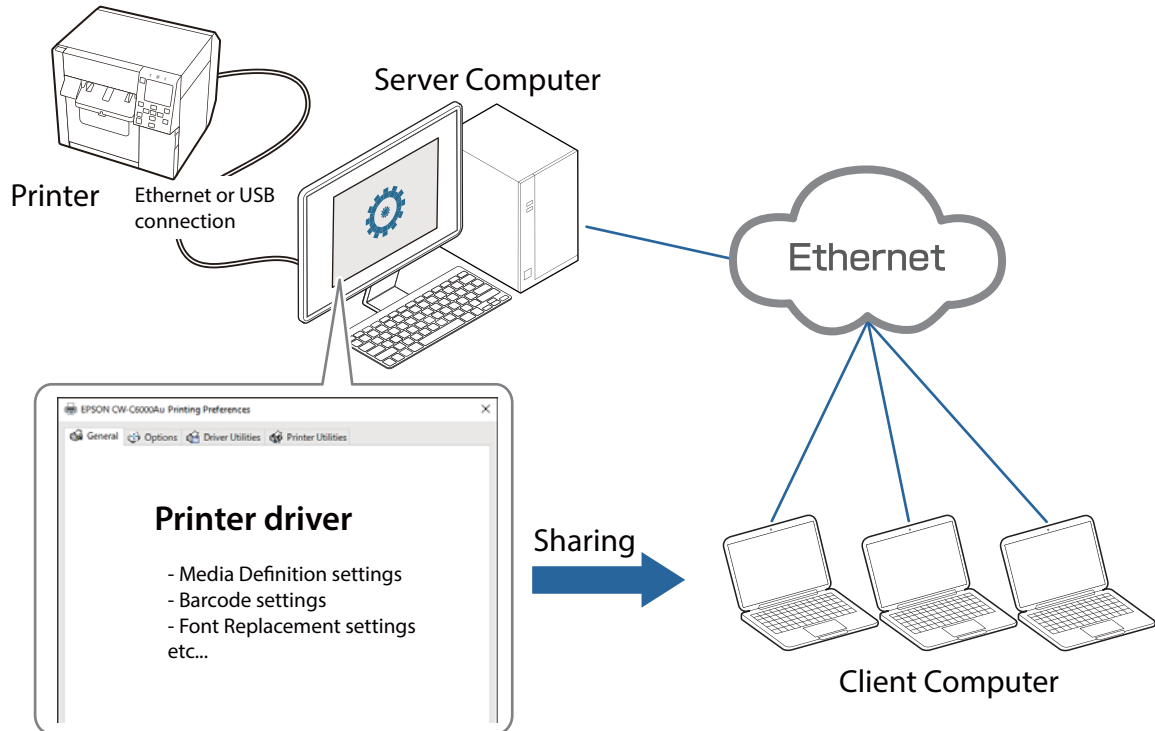

### IMPORTANT

Depending on configuration of your system, starting PrinterSetting ( [Page 189](#)) from the printer driver is disabled. "[Restrictions on using PrinterSetting](#)" on page 160



Ethernet connection allows you to control multiple printers if they are connected to the same network as the server computer.

Follow the steps below to enable sharing of the printer driver. For details of each step, see the linked page.

### Procedure on a Server Computer

**1. Install the printer driver ( [Page 51](#) )**

The installation procedure is the same as the normal installation procedure.

**2. Set up sharing settings on Windows [Devices and Printers] ( [Page 139](#) )**

**3. Enable Shared Print mode on the printer driver ( [Page 141](#) )**

**4. Add new settings such as user-defined paper (Media Definition) on the printer driver**

See "User-Defined Paper" on page 93, "Printing Barcodes" on page 100, or other pages as necessary.

**5. Change the default settings of the printer driver ( [Page 144](#) )**

Change the default printer driver settings to frequently used settings.



### Procedure on a Client Computer

**1. Connect to the server computer ( [Page 147](#) )**

**2. Check the settings of the shared printer driver ( [Page 154](#) )**

Check that the settings made at step 3 to 5 of "Procedure on a Server Computer" are correctly applied.



#### IMPORTANT

- Shared Print mode is a function that assumes that the server PC, client PC, and printer are all connected and running.
- When you add new settings to the printer driver such as user-defined paper (Media Definition) or barcode font, make sure to add them after enabling [Shared Print mode]. The settings you added before enabling [Shared Print mode] become disabled because save location of the settings files is changed when the mode is enabled.
- The settings for shared information can only be added or changed using administrator privileges. As an account with user privileges cannot write from either a server PC or client PC, adding, editing, and deleting operations for the following functions are disabled.
  - Media Definition settings
  - Barcode and 2D Symbol Settings
  - Font Replacement
  - Favorite Settings
- If the server PC and client PC are not connected, the shared information settings cannot be changed.

## Procedure on a Server Computer

### Setting up Sharing Settings on Windows [Devices and Printers]

- 1 Open [Devices and Printers].
- 2 Right-click the icon of the printer to be shared and then click [Printer properties].  
The Printer properties window appears.

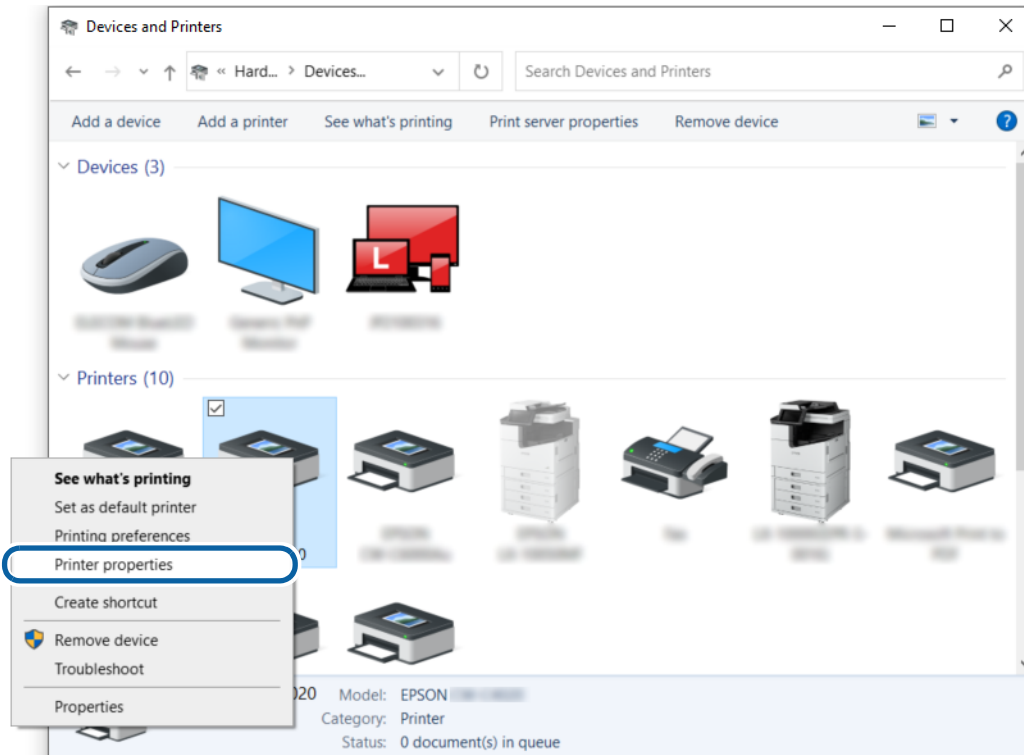

- 3 Click the [Sharing] tab, and then select the check box for [Share this printer].

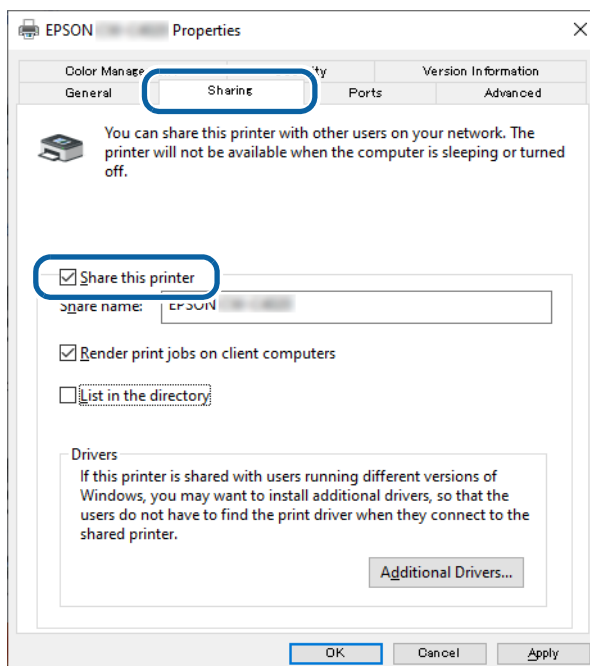

## 4 Select the check box for [Render print jobs on client computers].

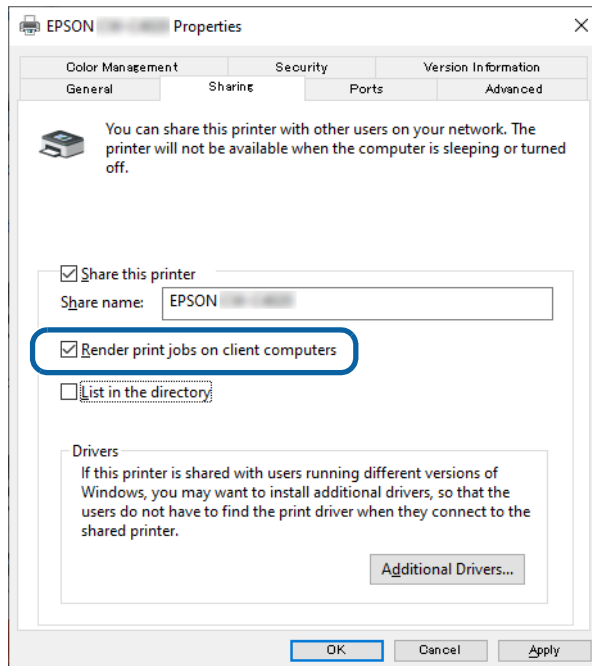

## 5 Click [OK].

## Enabling Shared Print Mode on the Printer Driver

- 1 Open [Devices and Printers].
- 2 Right-click the icon of the printer to be shared and then click [Printer properties].  
The Printer properties window appears.

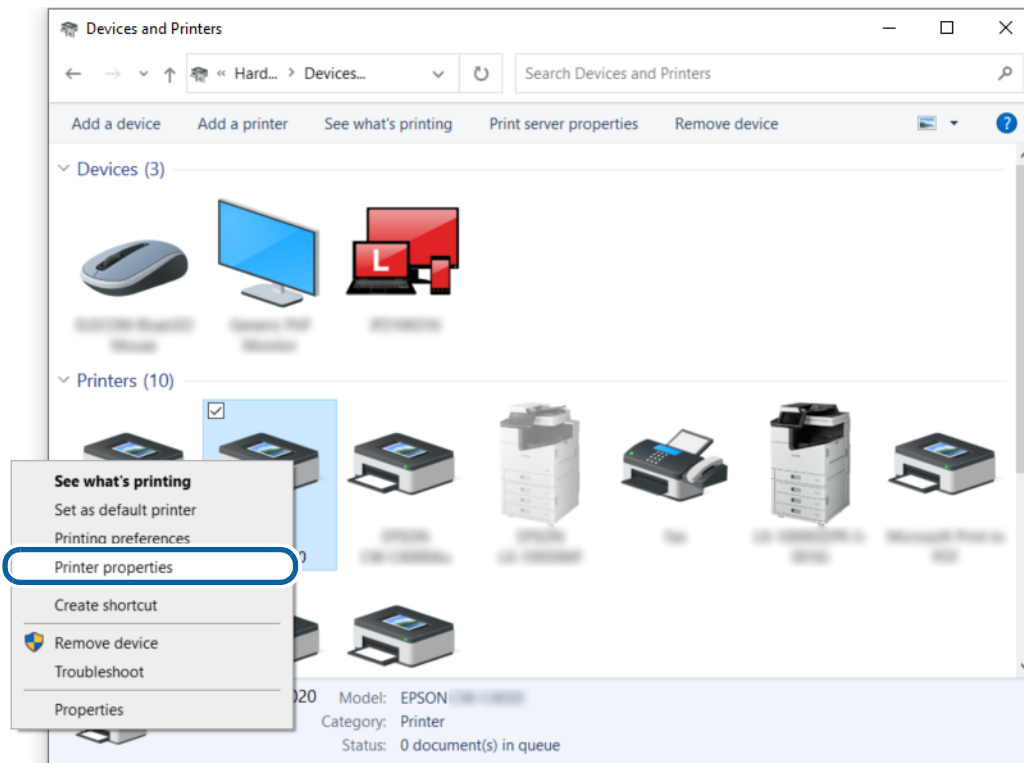

- 3 Click the [Advanced] tab, and then click [Printing Defaults...].

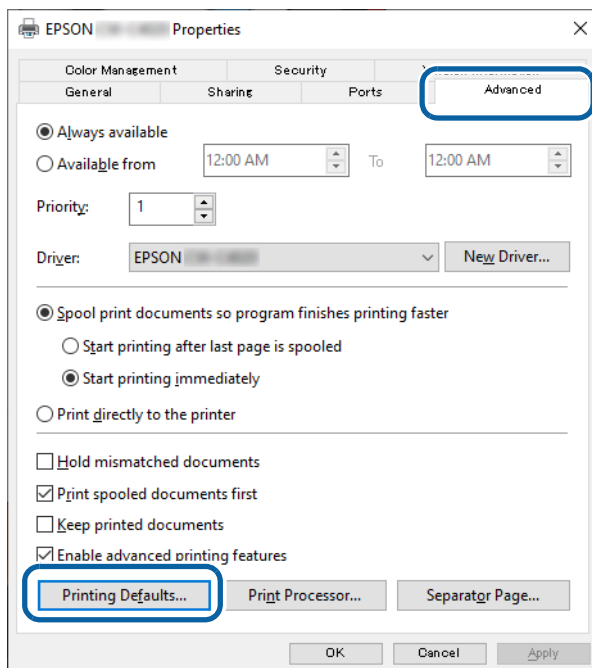

- 4** When print settings window appears, select the [Driver Utilities] tab, and then click [Driver Preferences].

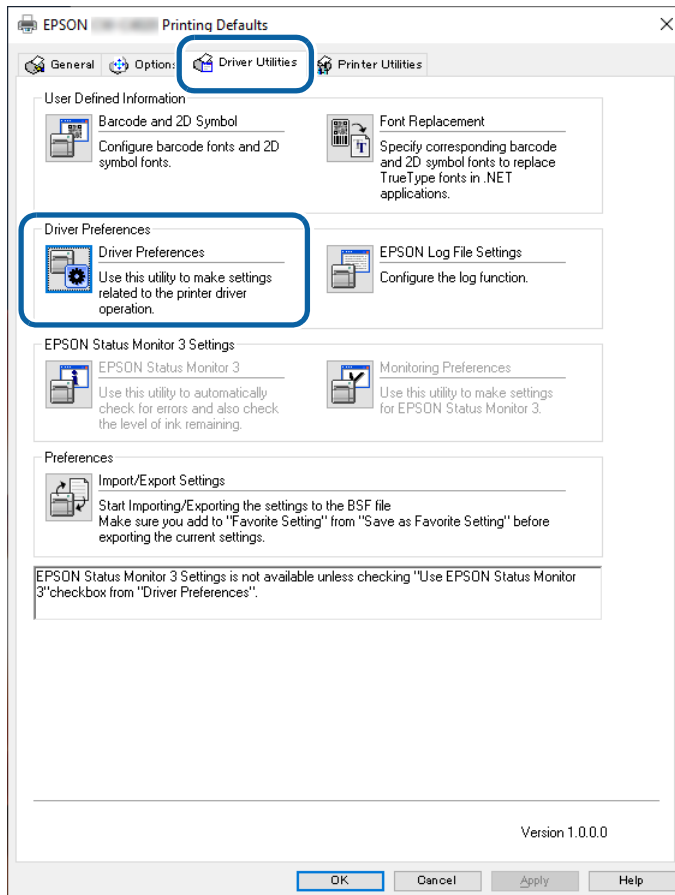

- 5** On the "Driver Preferences" window, select the check box for [Use EPSON Status Monitor 3] and [Shared Print mode].

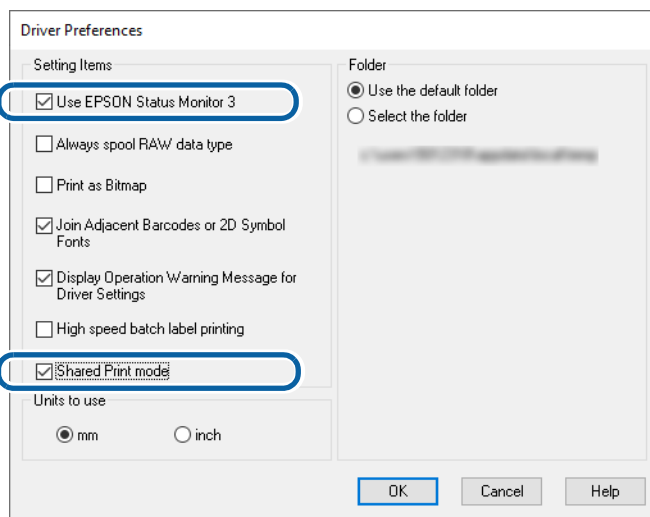

- 6** Click [OK] to return to the previous print settings window.
- 7** Click [Monitoring Preferences] on the "Driver Utilities" tab. The "Monitoring Preferences" window appears.

- 8 Select the check box for [Allow monitoring of shared printers], and then click [OK].

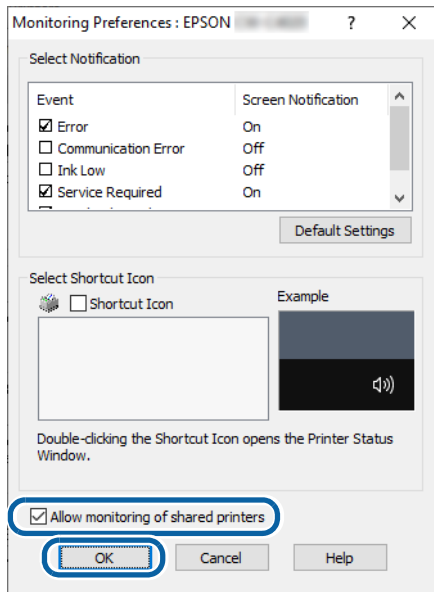

- 9 When the print settings window reappears, click [OK].  
The [Shared Print mode] setting is enabled from the next time you open the print settings window of the printer driver.

## Changing the Default Settings of the Printer Driver

You can change the default settings of the printer driver to frequently used settings such as selecting paper you added at [Media Definition]. This saves you the trouble of changing the settings each time you print.

If necessary, first add [Media Definition] settings ("[User-Defined Paper](#)" on page 93), barcode font ("[Printing Barcodes](#)" on page 100), or other settings, and then follow the procedure below to change the default settings.

### IMPORTANT

- When you add new settings to the printer driver such as user-defined paper (Media Definition) or barcode font, make sure to add them after enabling [Shared Print mode]. The settings you added before enabling [Shared Print mode] become disabled because save location of the settings files is changed when the mode is enabled.
- If you log in to the server or client computer with user privileges after setting up sharing settings, adding, editing, or deleting operations for the following functions are disabled because shared information is write-protected. Log in to the computer with administrator privileges.
  - Media Definition settings
  - Barcode and 2D Symbol Settings
  - Font Replacement
  - Favorite Settings

- 1 Open [Devices and Printers].
- 2 Right-click the icon of the printer to be shared and then click [Printer properties].  
The Printer properties window appears.

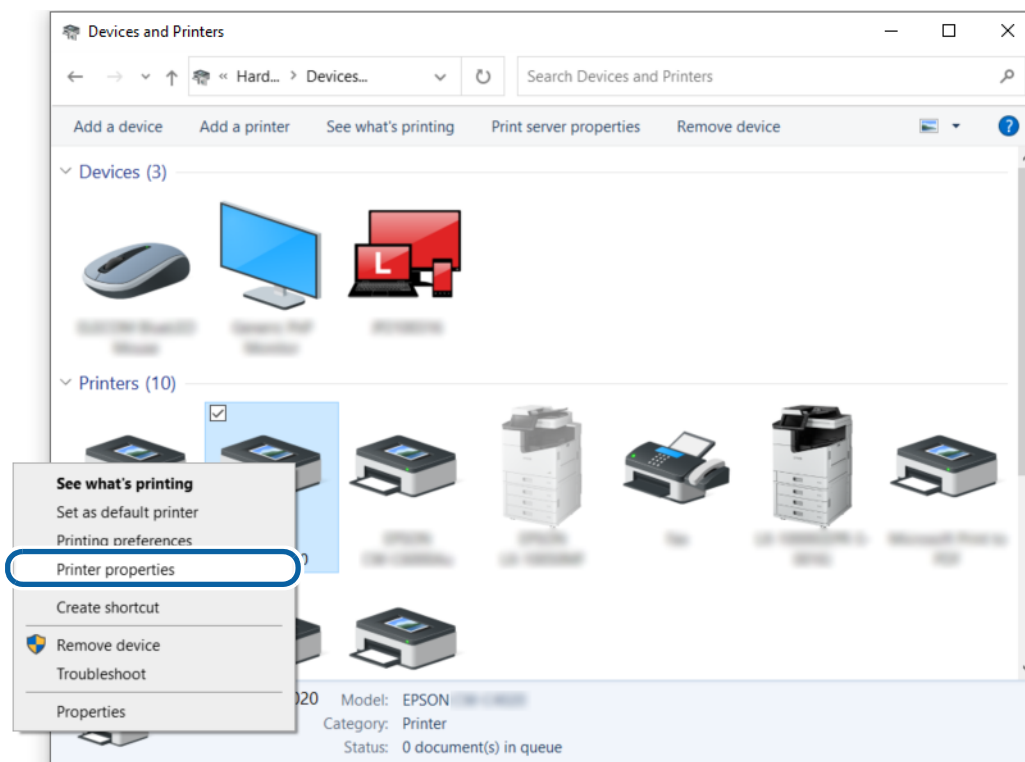



### 3 Click the [Advanced] tab, and then click [Printing Defaults...].

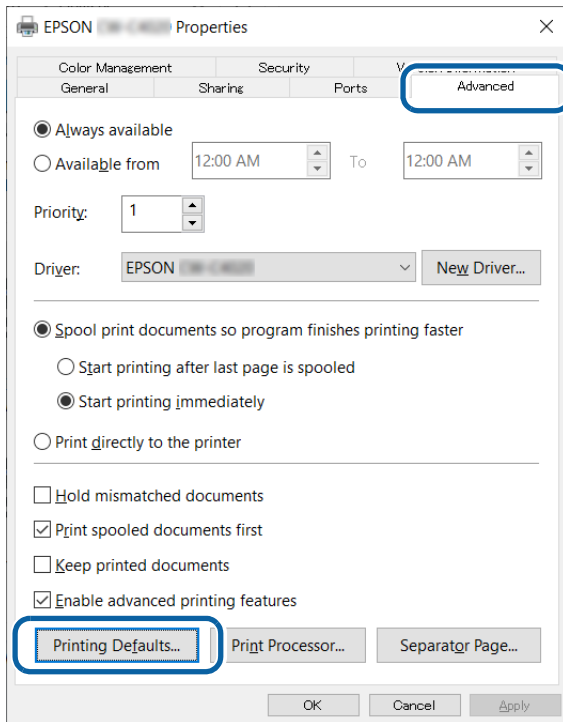

### 4 When the print settings window appears, change paper and other settings to frequently used settings.

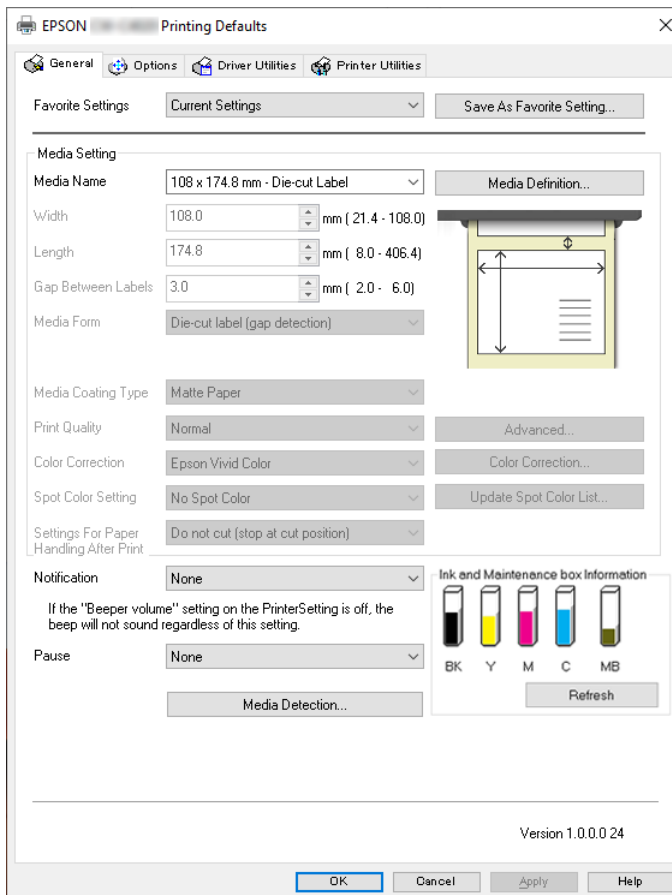

**5** When finished, click [OK] to save the changes.

From the next time you open the printer driver, the print setting you made here will be reflected.

## Procedure on a Client Computer

### Connecting to the Server Computer

- 1 Open [Devices and Printers] and then click [Add a printer] on the menu bar. Searching for a printer is started.

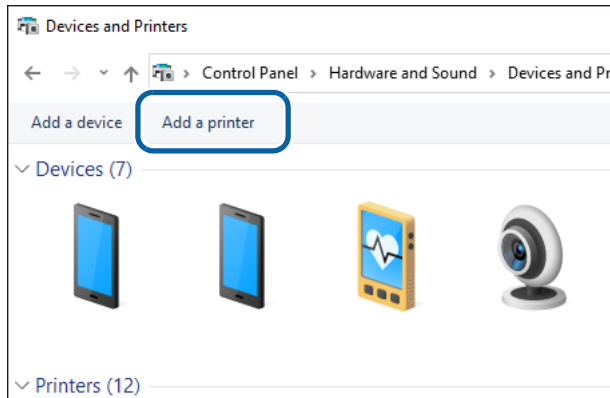

- 2 When the target printer is displayed, click on it. If the printer is not displayed, go to ["Connecting to the Server Computer \(When the Printer is Not Found\)"](#) on page 150.

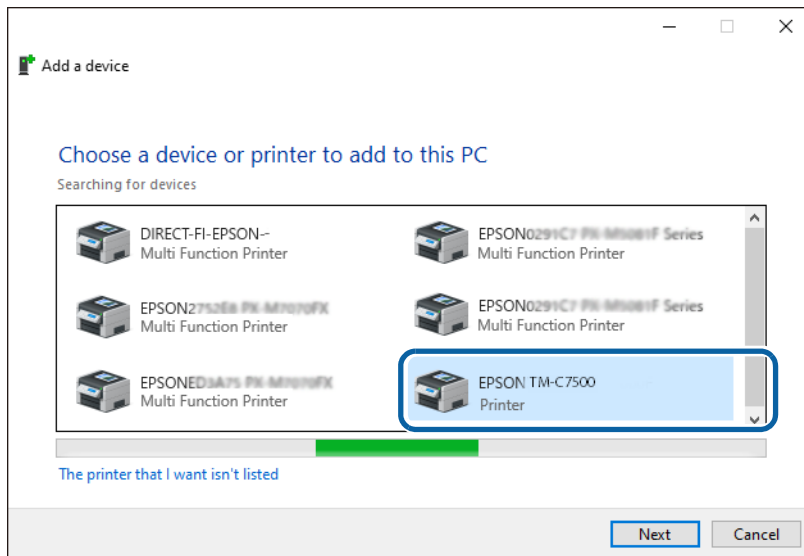

- 3 Wait until installation of the printer driver is finished.

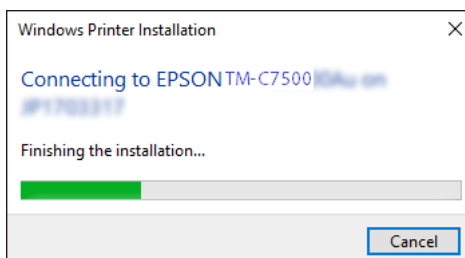

- 4** When the installation finishes successfully, the window below is displayed. Click [Next].

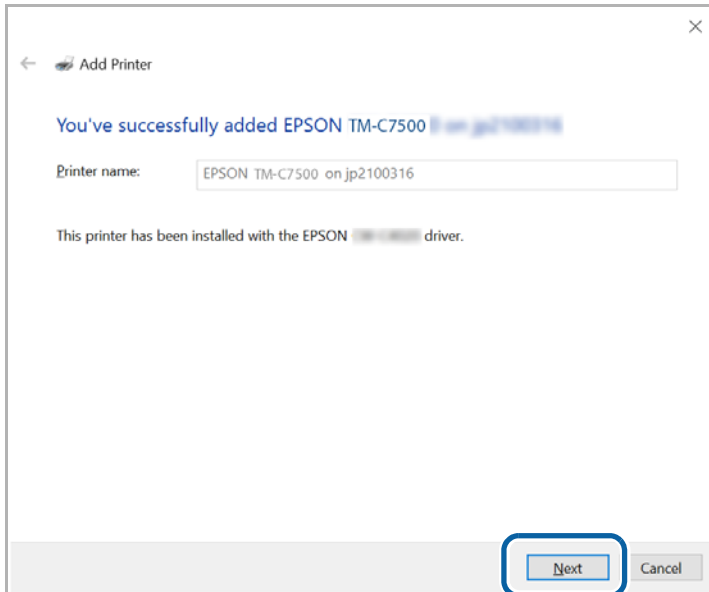

- 5** The window shown below is displayed. Click [Print a test page] to test whether printing from the printer is possible, or click [Finish] to finish.

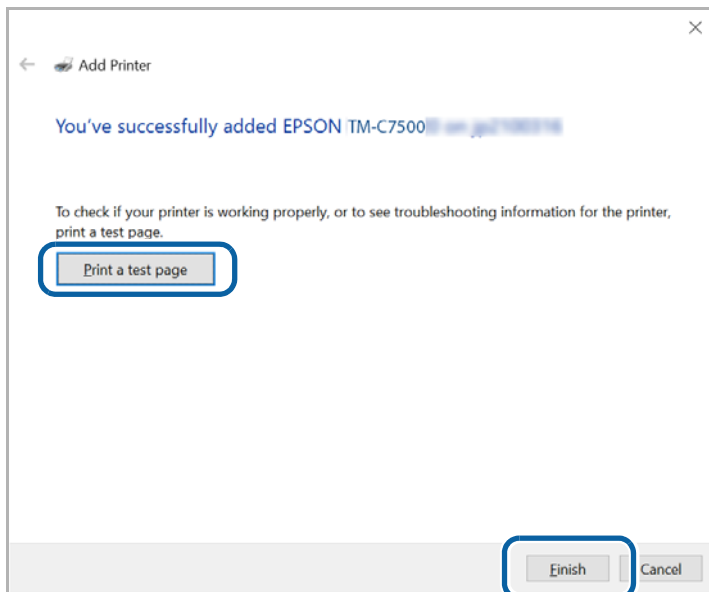

## 6 Open [Devices and Printers] again to check that the printer has been added in the window.

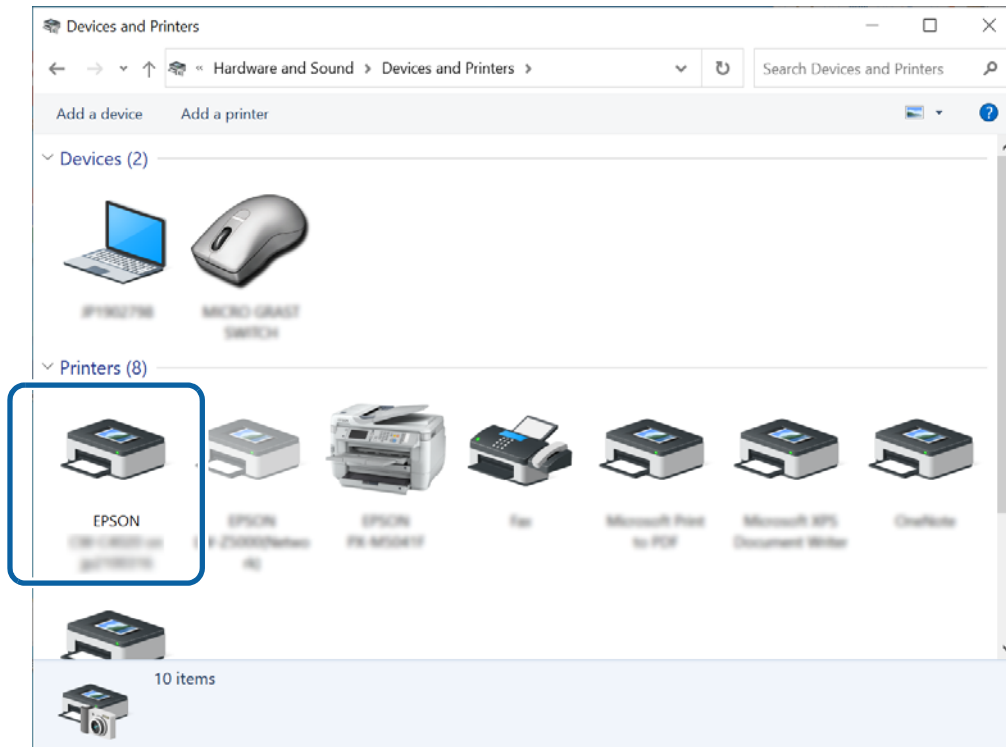

## Connecting to the Server Computer (When the Printer is Not Found)

If the printer is not displayed after clicking the [Add a printer] menu in [Devices and Printers], follow the procedure below.

- 1 Click [The printer that I want isn't listed] at the bottom of the printer search window.

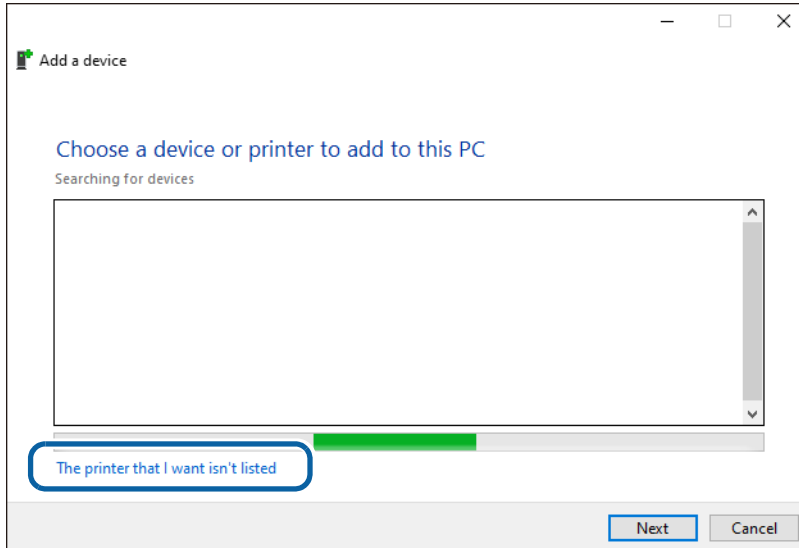

- 2 When the window shown below appears, select [Select a shared printer by name] and then click [Browse].

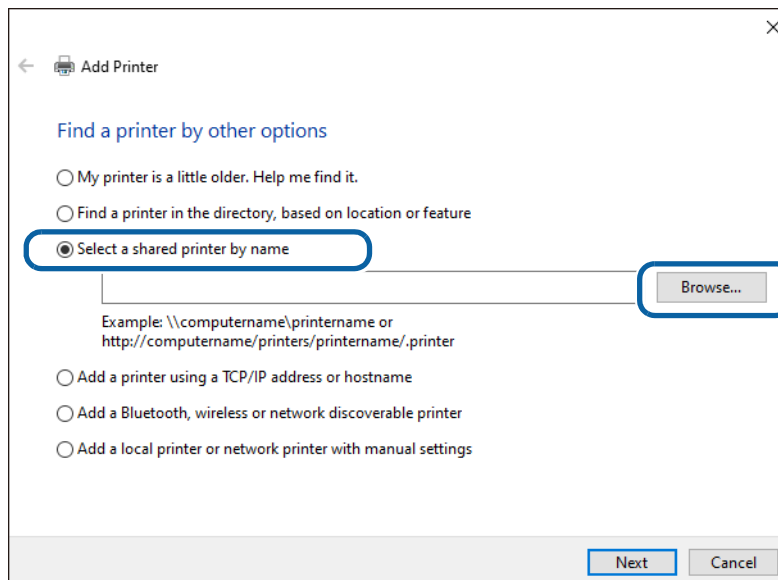

- 3** When the server computer is displayed under [Network], click on it. All devices shared on the server computer are listed.

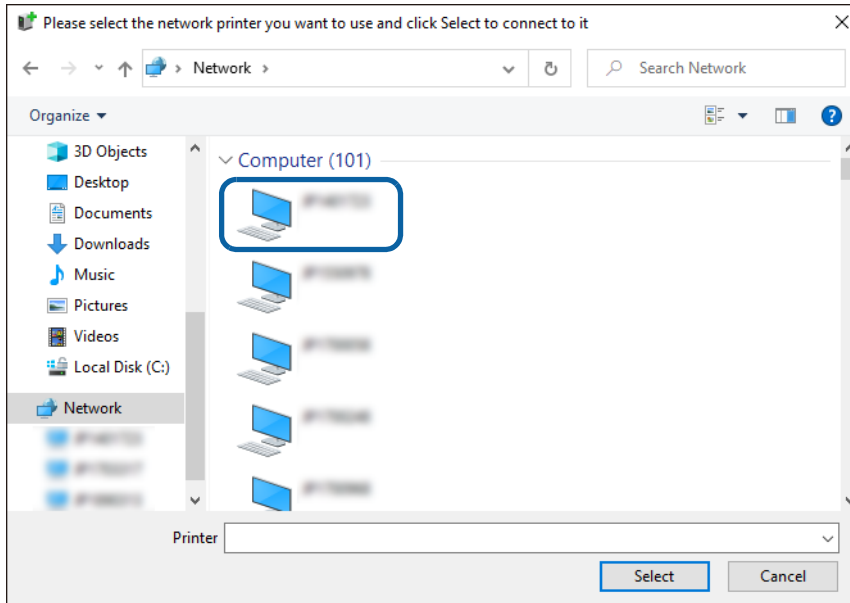

If network discovery has been disabled on the computer, change the setting to enable network discovery.

- 4** Click on the target printer. Check that the printer name is correct, and then click [Select].

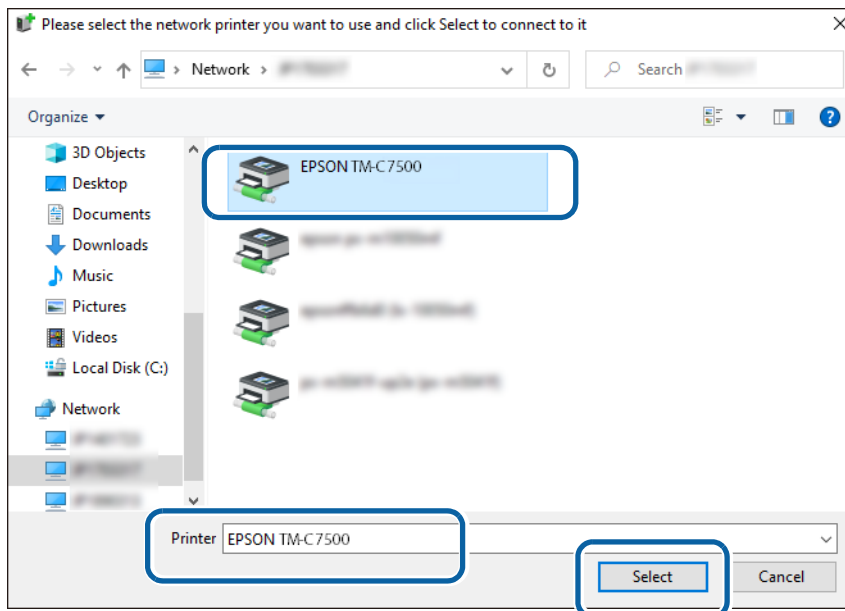

- 5** When the window shown below is displayed, click [Next].  
Wait until installation of the printer driver is finished.

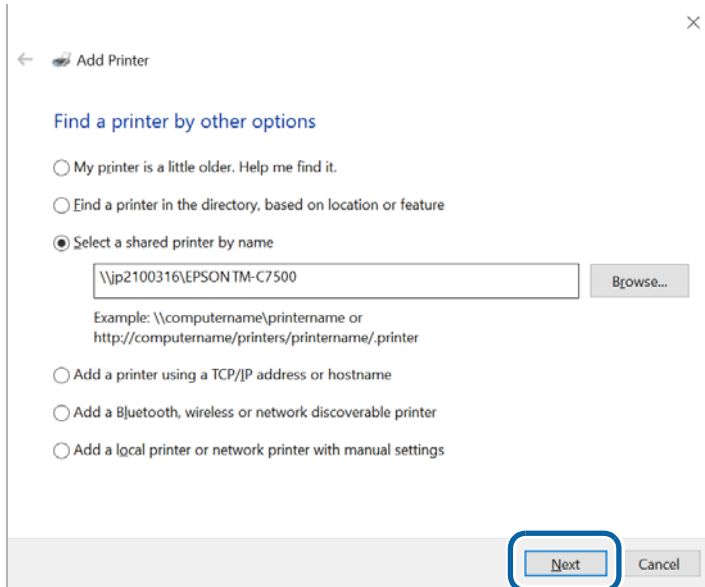

- 6** When the installation finishes successfully, the window below is displayed. Click [Next].

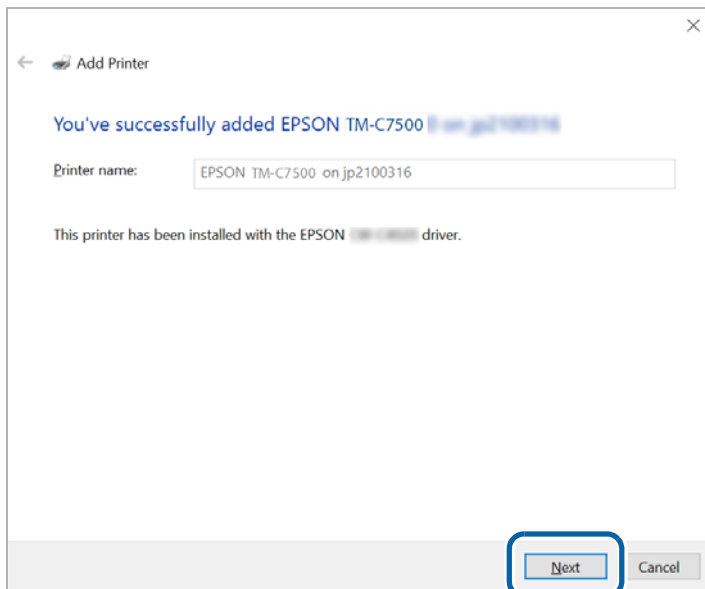



- 7** The window shown below is displayed. Click [Print a test page] to test whether printing from the printer is possible, or click [Finish] to finish.

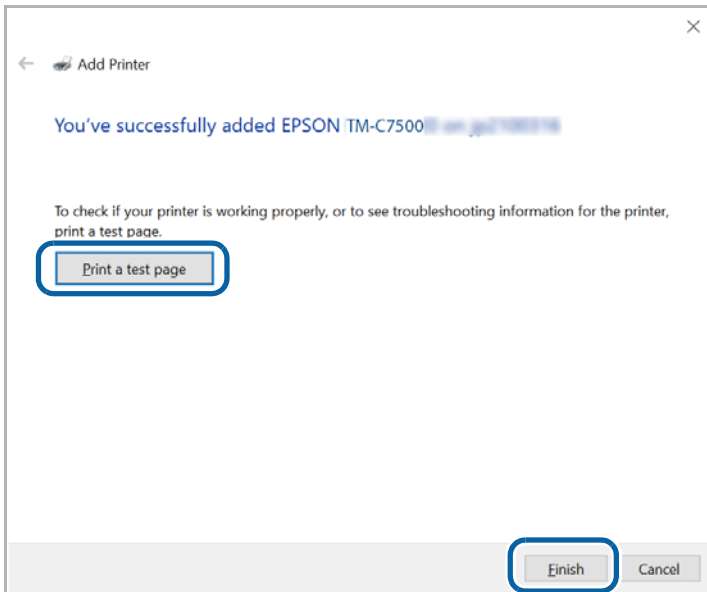

- 8** Open [Devices and Printers] again to check that the printer has been added in the window.

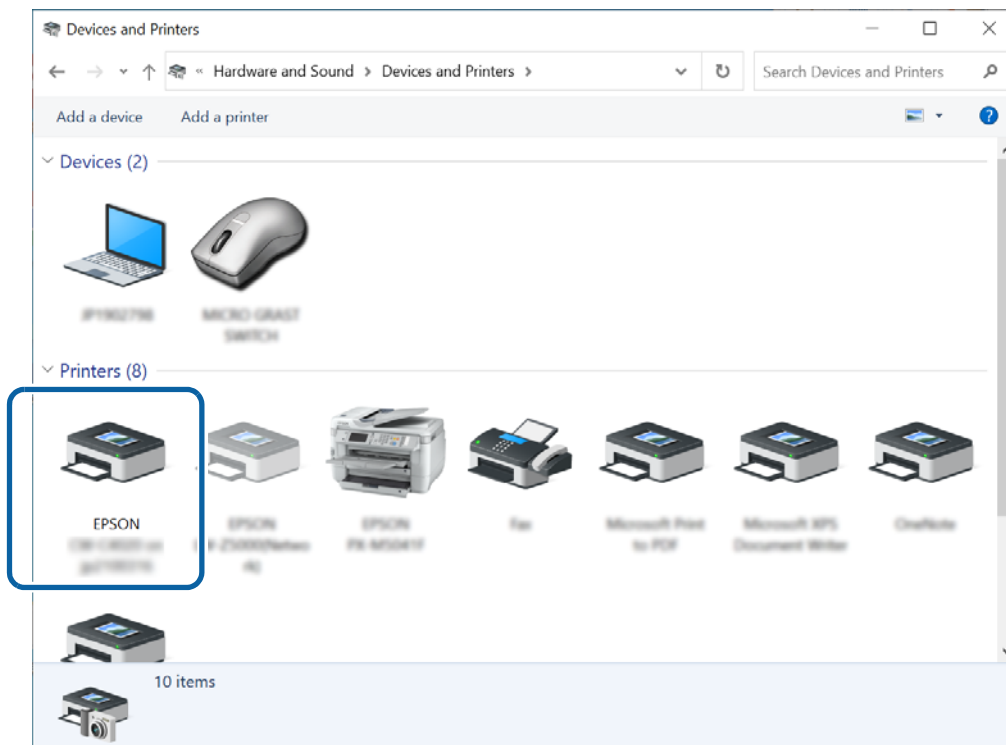

## Checking the Settings of the Shared Printer Driver

There are the following two methods for checking the printer driver settings.

- Open the printer driver window from application software you use and check the settings ( [Page 154](#) )
- Open the printer driver window from [Devices and Printers] and check the settings ( [Page 157](#) )

### ❑ Checking the Settings from Application Software, taking Paint for example

#### 1 Select [Print] from the [File] menu.

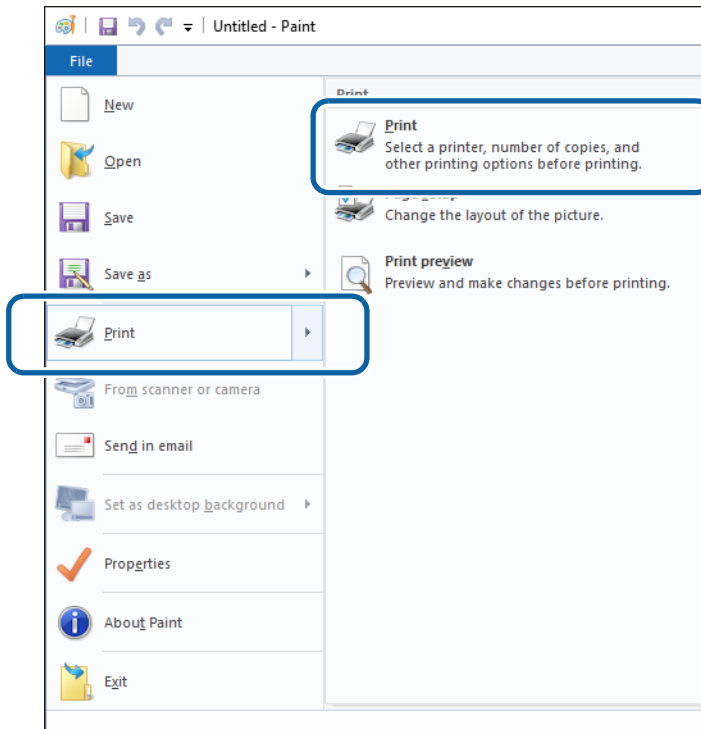

#### 2 In the "Print" window, select the target printer and then click [Preferences]. The printer driver print settings window is displayed.

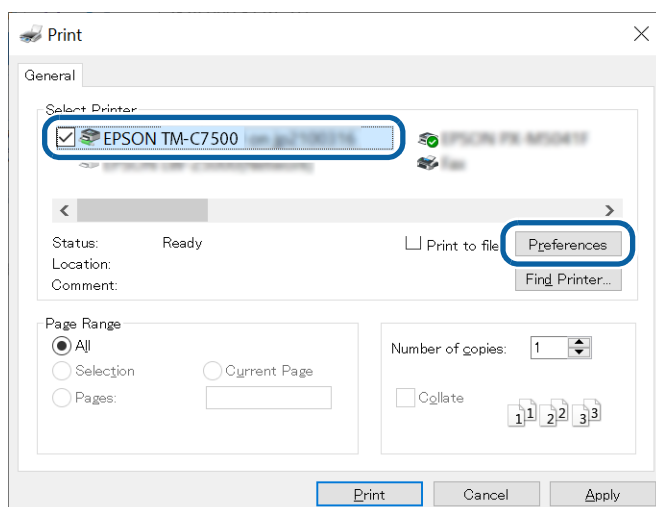

### 3 Check the print settings.

Check that the settings such as the selected media (paper) are the same as those you made at "Changing the Default Settings of the Printer Driver" on page 144. When finished checking the settings, go to the next step.

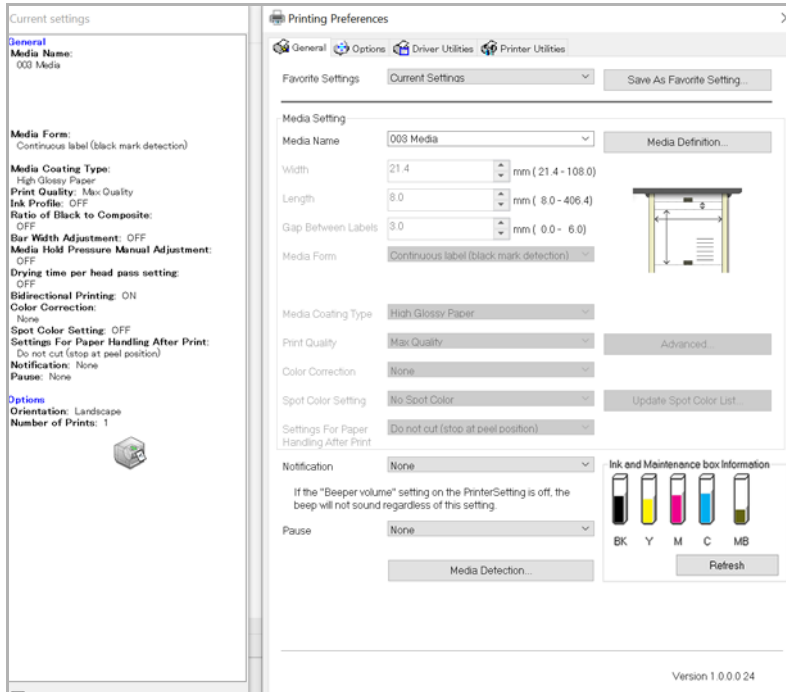

### 4 Select the [Driver Utilities] tab, and then click [Driver Preferences].



**5** On the “Driver Preferences” window, check that the check box for [Shared Print mode] has been selected.

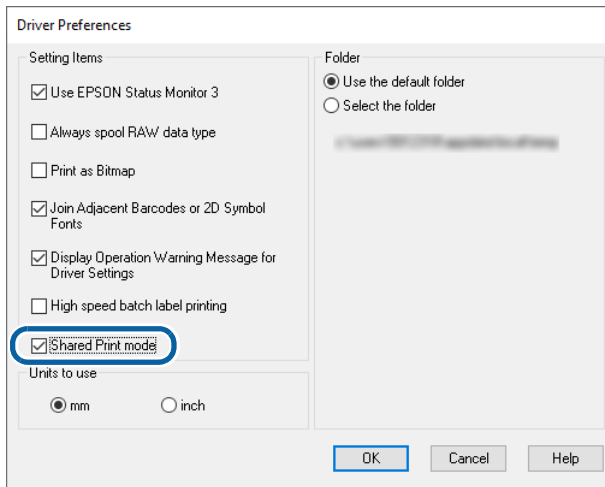

## ❑ Checking the Settings from [Devices and Printers]

- 1 Open [Devices and Printers].
- 2 Right-click on the target printer, and then click [Printing preferences].  
The printer driver print settings window is displayed.

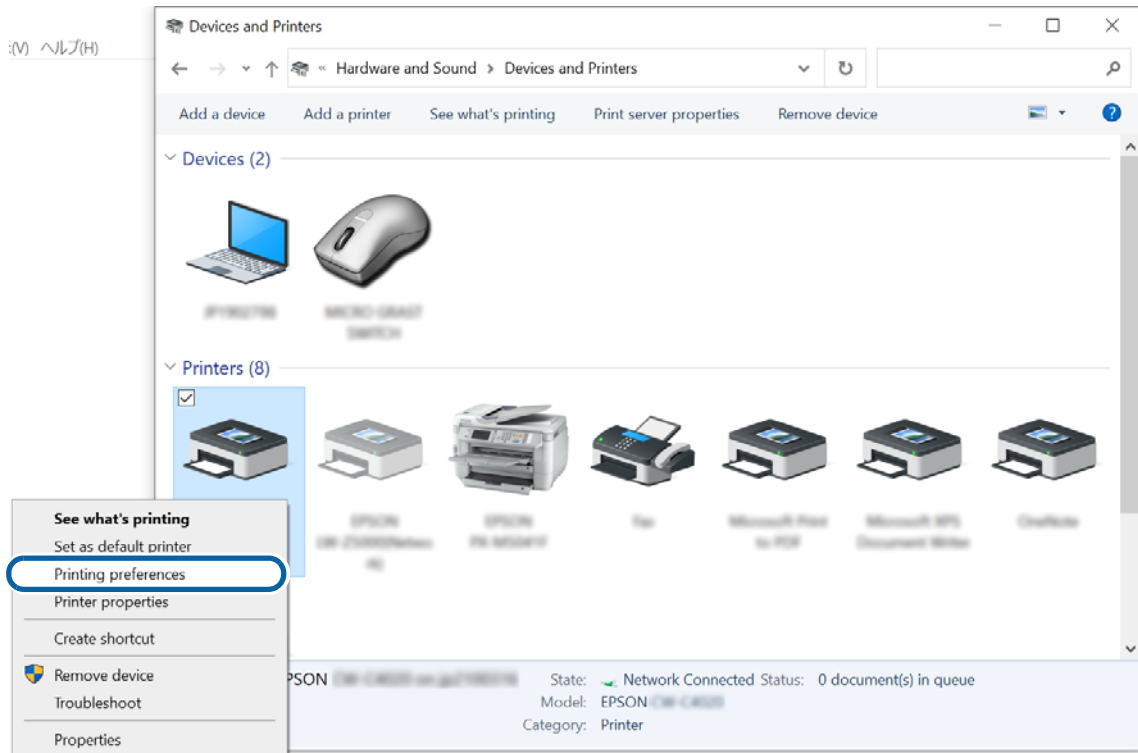

### 3 Check the print settings.

Check that the settings such as the selected media (paper) are the same as those you made at "Changing the Default Settings of the Printer Driver" on page 144. When finished checking the settings, go to the next step.

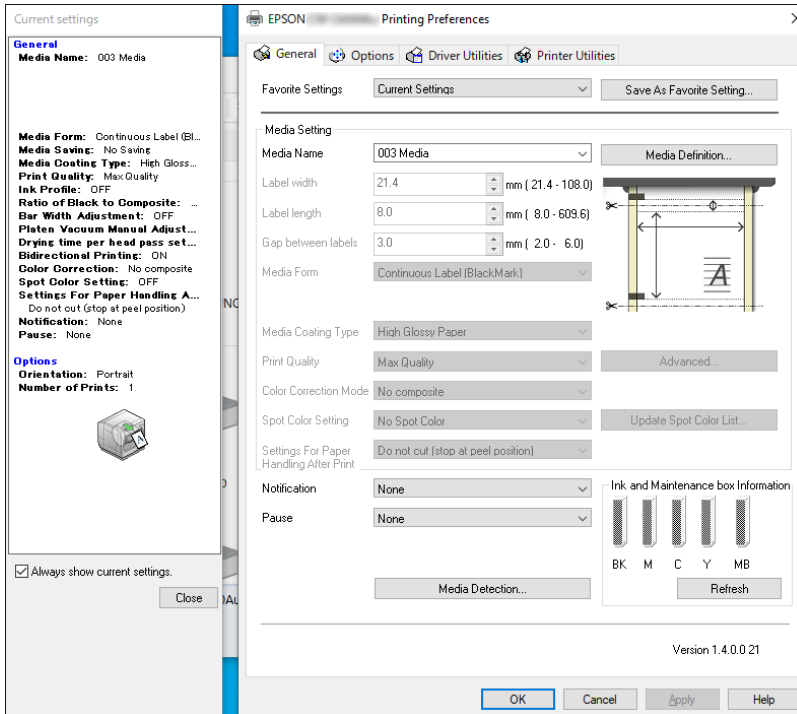

### 4 Select the [Driver Utilities] tab, and then click [Driver Preferences].

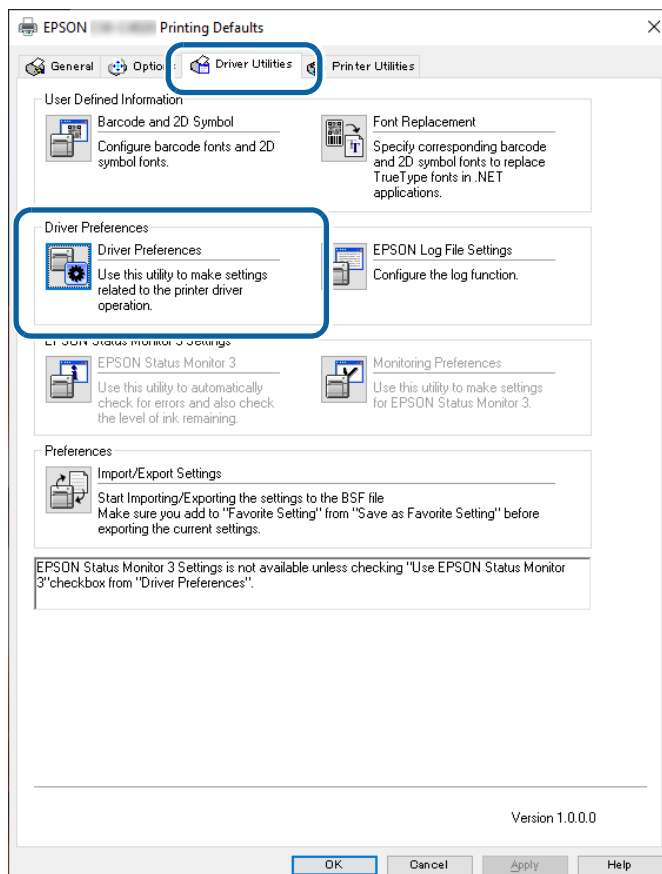

- 5** On the “Driver Preferences” window, check that the check box for [Shared Print mode] has been selected.

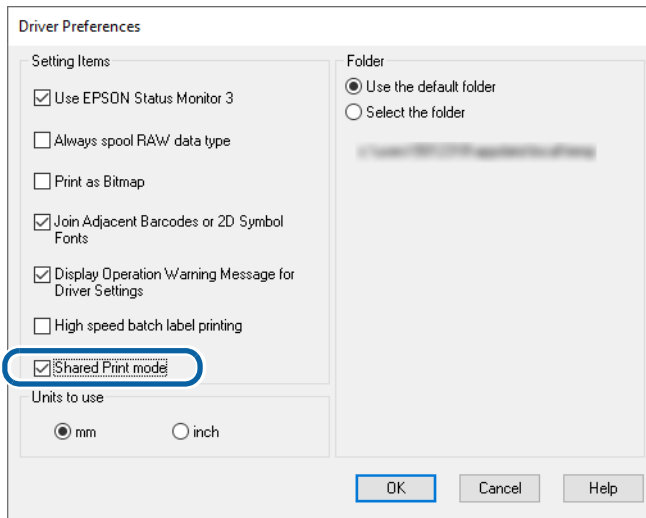

- 6** Click [Cancel] to close the “Driver Preferences” window and return to the previous print settings window.
- 7** Click [Cancel] or click [X] at the upper right corner to close the print settings window.



**IMPORTANT**

Do not click [OK] to close the print settings window that was displayed from [Devices and Printers] on a client computer. If you click [OK], the settings are saved on the client computer and the link with the server computer is disconnected.

## Restrictions on using PrinterSetting

Depending on configuration of your system, starting PrinterSetting (Printer Settings Utility) from the “Printer Utilities” tab is disabled.

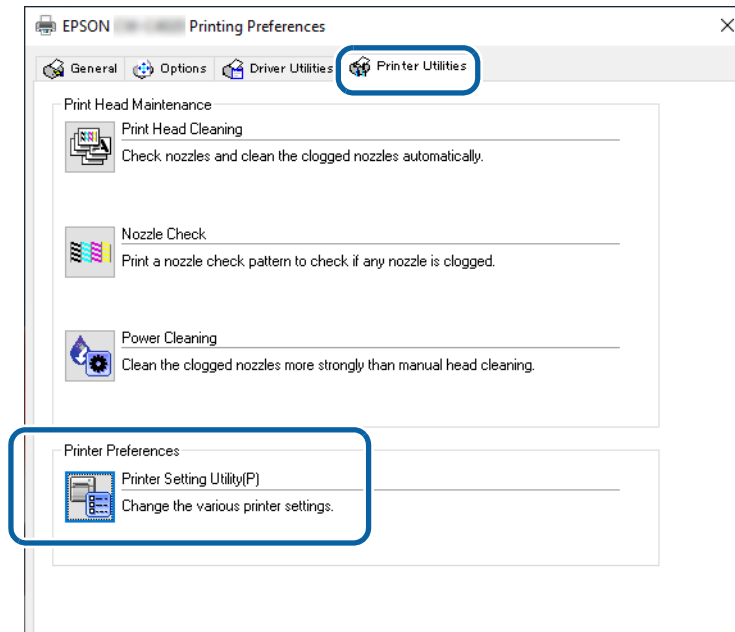

The table below shows system configuration examples and their restrictions on using PrinterSetting.

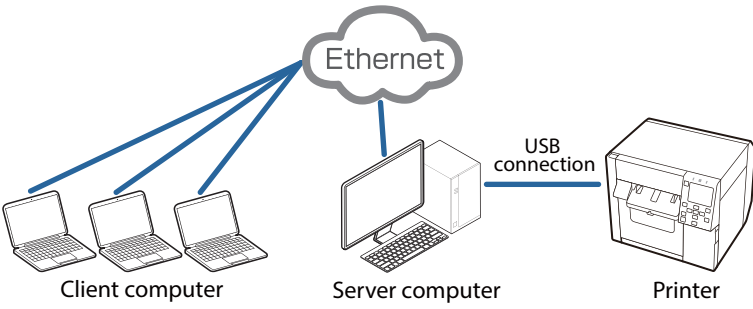
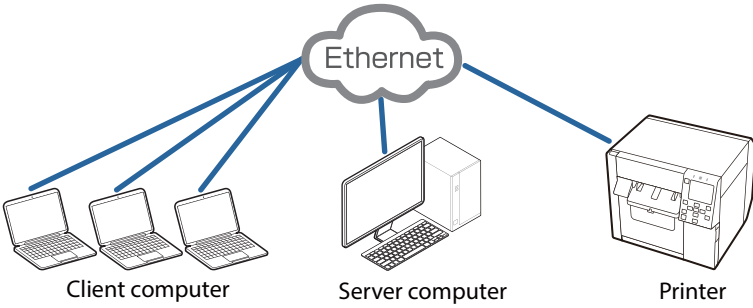
System Configuration	Starting PrinterSetting	
	Server Computer	Client Computer
<p>The printer is connected to the server computer via USB. The server and the client computers are connected via Ethernet.</p> 	Possible	Not possible
<p>The printer, the server, and the client computers are connected via Ethernet.</p> 	Possible	Possible after installing PrinterSetting application



## Setting EPSON Status Monitor 3

EPSON Status Monitor 3 displays a pop-up window to inform you specified paper type and ink levels when you start printing. In addition, if a fatal error occurs, it displays an error window. It is disabled by default.

### Enabling/Disabling EPSON Status Monitor 3

By default, EPSON Status Monitor 3 is disabled.

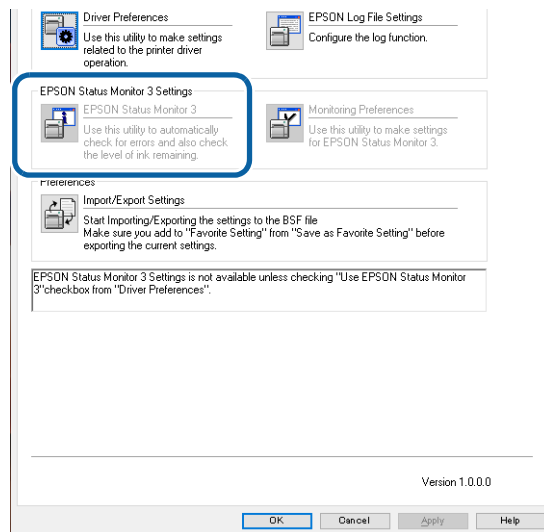

Follow the procedure below to enable EPSON Status Monitor 3.

- 1** Turn the printer on.
- 2** Open the printer driver window.
- 3** Select the [Driver Utilities] tab and then click [Driver Preferences] in the Driver Preferences field.
- 4** The Driver Preferences window appears. Select the check box for [Use EPSON Status Monitor 3], and then click [OK].

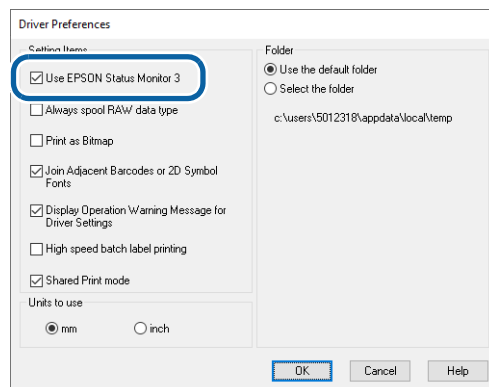

- 5** In the [EPSON Status Monitor 3 Settings] field on the [Driver Utilities] window, [EPSON Status Monitor 3] and [Monitoring Preferences] are displayed.

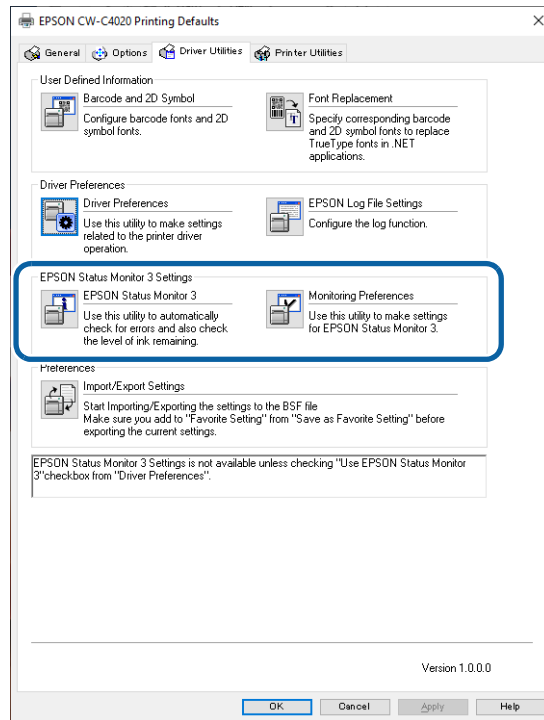

## Using EPSON Status Monitor 3

When EPSON Status Monitor 3 is enabled, the following functions become available.

- A window to inform you the printer status and ink levels is automatically displayed when you start printing.
- You can check the consumables information on the General tab of the printer driver.
- When an error occurs during printing, the error information is displayed.  
IF an error occurs on the printer while it is not printing, EPSON Status Monitor 3 does not start.
- You can start EPSON Status Monitor 3 anytime by clicking its icon on the task bar.  
For information on how to display the icon, refer to ["Displaying the Icon" on page 166](#).

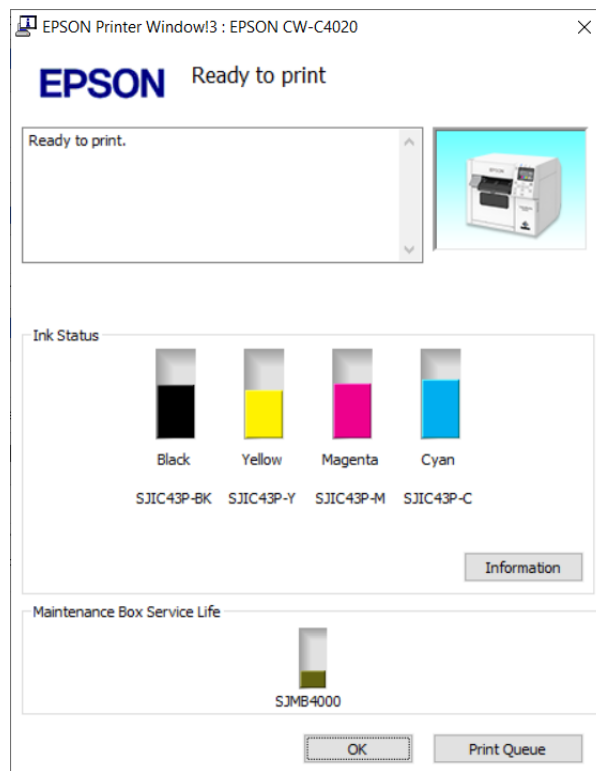

EPSON Status Monitor 3 window

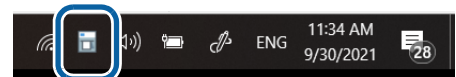

Icon on the task bar

- You can set the following in the [Monitoring Preferences] settings.  
Display the EPSON Status Monitor 3 icon on the task bar.  
(See "Displaying the Icon" on page 166.)

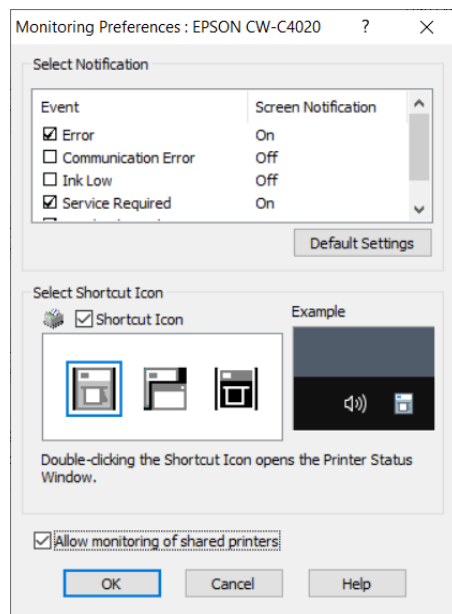

## Error Notification Settings

Follow the procedure below to change the error notification settings of EPSON Status Monitor 3.

- 1 Turn the printer on.**
- 2 Open the printer driver window.**
- 3 Select the [Driver Utilities] tab and then click [Monitoring Preferences].**  
If you have not enabled EPSON Status Monitor 3, [Monitoring Preferences] is not displayed. Enable EPSON Status Monitor 3 referring to "[Enabling/Disabling EPSON Status Monitor 3](#)" on page 161.
- 4 The Monitor Preferences window appears. Select the check boxes for the items that you want to be notified, and then click [OK].**

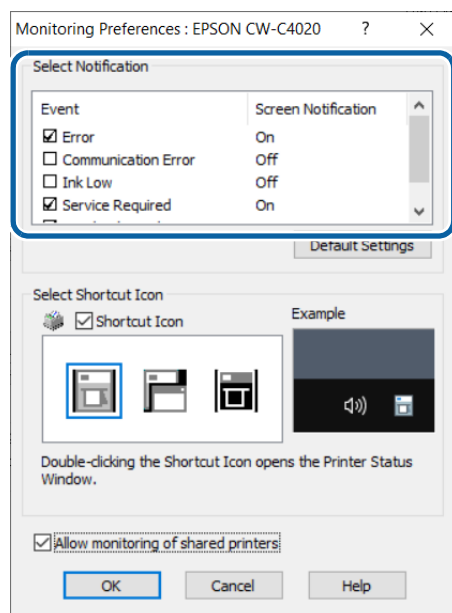

- Error: When paper/ink replacement is required (Default: Screen Notification [On])
- Communication Error: When the printer power is off (Default: Screen Notification [Off])
- Ink Low: When the ink amount is low (Default: Screen Notification [Off])
- Service Required: When a printer error occurs (Default: Screen Notification [On])
- Nozzle Clogged Warning: When the nozzles get clogged (Default: Screen Notification [On])

## Displaying the Icon

You can set to show the icon on the task bar, and check the printer status by clicking the icon. The icon is not displayed by default. Follow the procedure below to display the icon.

- 1 Turn the printer on.**
- 2 Open the printer driver window.**
- 3 Select the [Driver Utilities] tab and then click [Monitoring Preferences].**
- 4 The Monitor Preferences window appears. Select the check box for [Shortcut Icon], and then select an icon image you want to display on the task bar. Click [OK].**

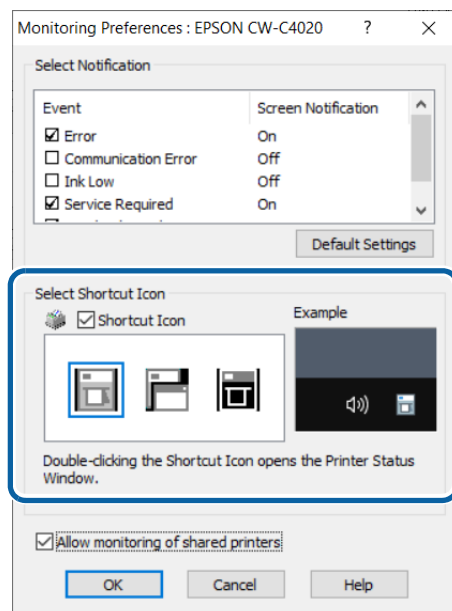

## Restrictions on Using the Printer Driver

- Keep the Bidirectional Printing function enabled. It can be set in [Advanced] that is a sub menu of [Print Quality] in [Media Settings].
- The printer driver does not support printing a background image.
- To print multiple print jobs in time order, disable [Print spooled document first]. If the printer driver receives multiple print jobs with [Print spooled document first] enabled, the print jobs may not be printed in time order.

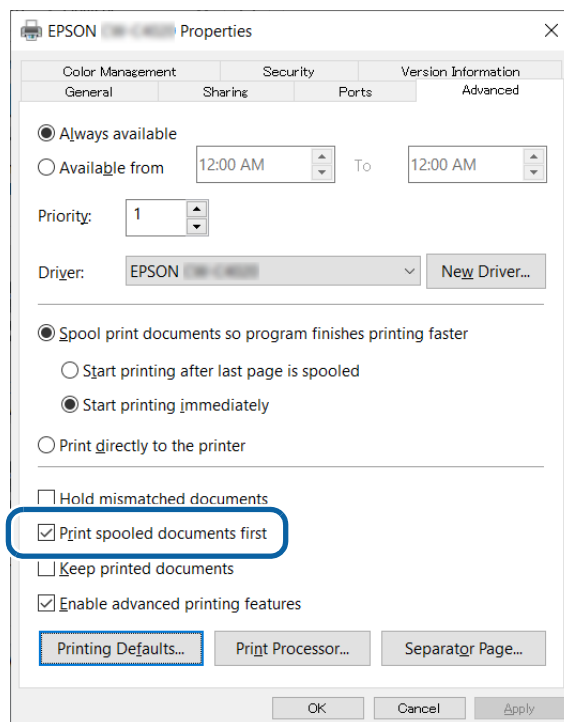

- When using Epson printer driver, do not change the control prefix, the format prefix, and the delimiter string that are included in ESC/Label command from their defaults. If you change them, printing will not be performed or result in producing unintended printouts. For their default settings, see "[Operation Panel Settings](#)" on page 230 and find [Printer Settings] - [Print Settings] - [Command Character].

## Isolating the Printer Driver

You can improve the reliability of the Windows print service by running the printer driver in a separate process from the process that runs the print spooler. This is available by using the isolation function.

Follow the procedure below to enable the isolation of the printer driver.

### 1 Select [Start] – [Windows Administrative Tools] – [Print Management].

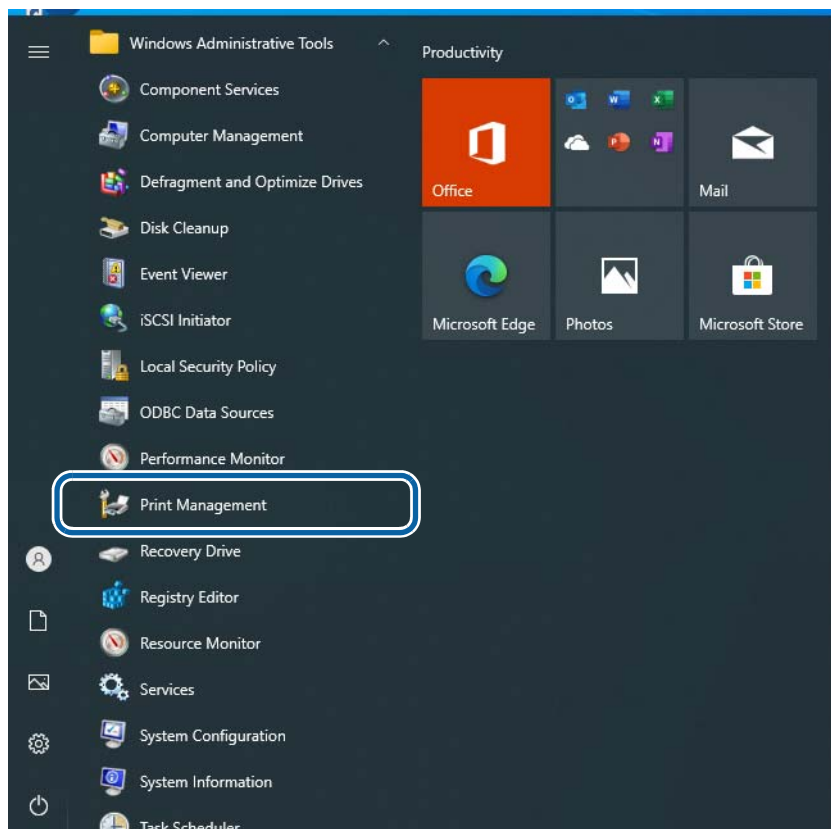



## 2 From [Driver Name], select [EPSON CW-C4000u].

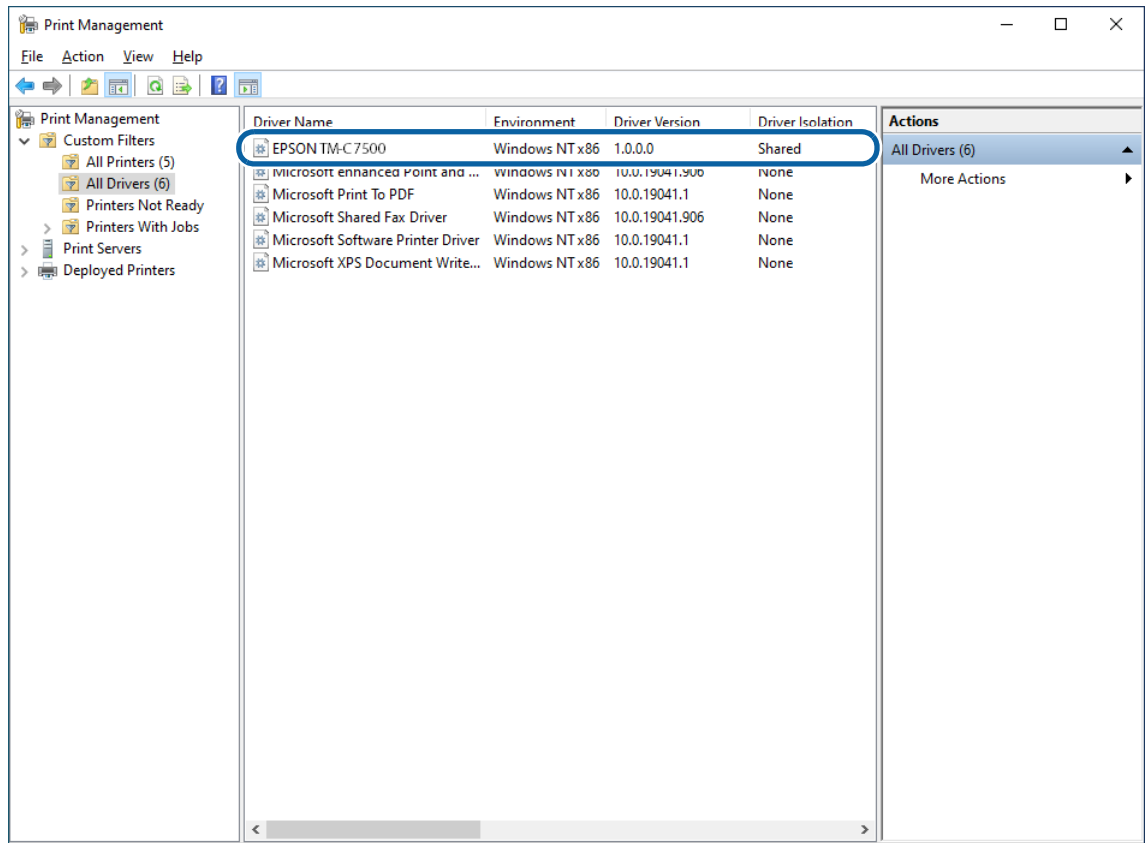

The above step is an example when your printer name is "EPOSN CW-C4000u".

## 3 Select [Actions] – [More Action] – [Set Driver Isolation] – [Isolated].

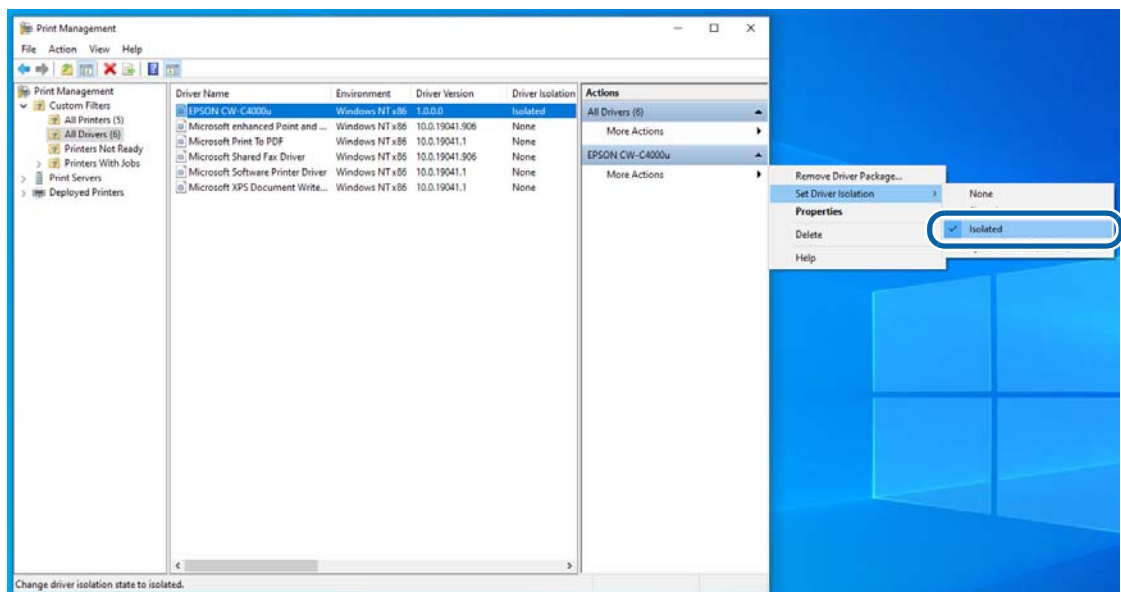

## Printer Driver for Mac

This chapter describes how to operate the printer driver for Mac.

The printer driver is software to control the printer in accordance with the print instructions of application software.

Setting the print settings in the printer driver screen enables you to obtain the best print results. Furthermore, you can also use the utilities to check the printer status and perform maintenance.

### Basic Procedure for Printing

- 1 Turn on the printer, and then load paper in the printer. ("Loading Paper" on page 66)
- 2 Create data to print on an application software, then select the [File] menu and click [Print].

The following screenshots are from Preview of Mac OS X.

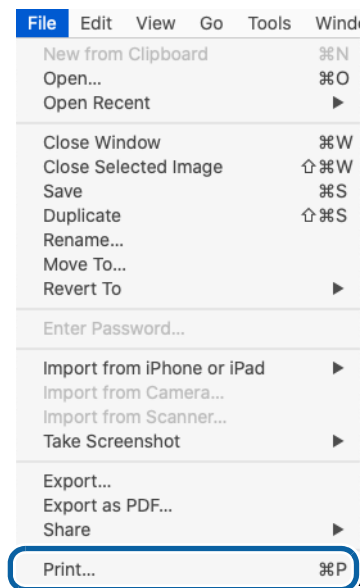

- 3 Click [Show Details] (or ) on the bottom of the screen.

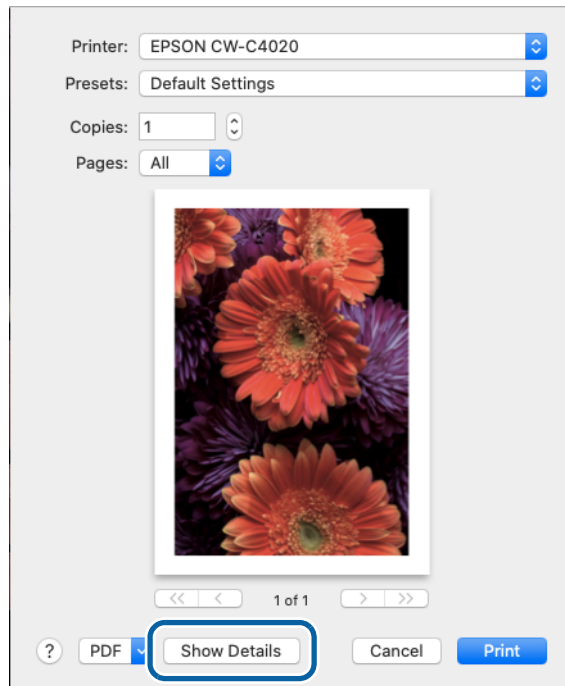

If page settings are not displayed in the print dialog, click the “page settings” option (e.g., Page Setup) in the File menu.

- 4 Check that this printer is selected, and then set the paper size. Select [Custom] to set a custom paper size.

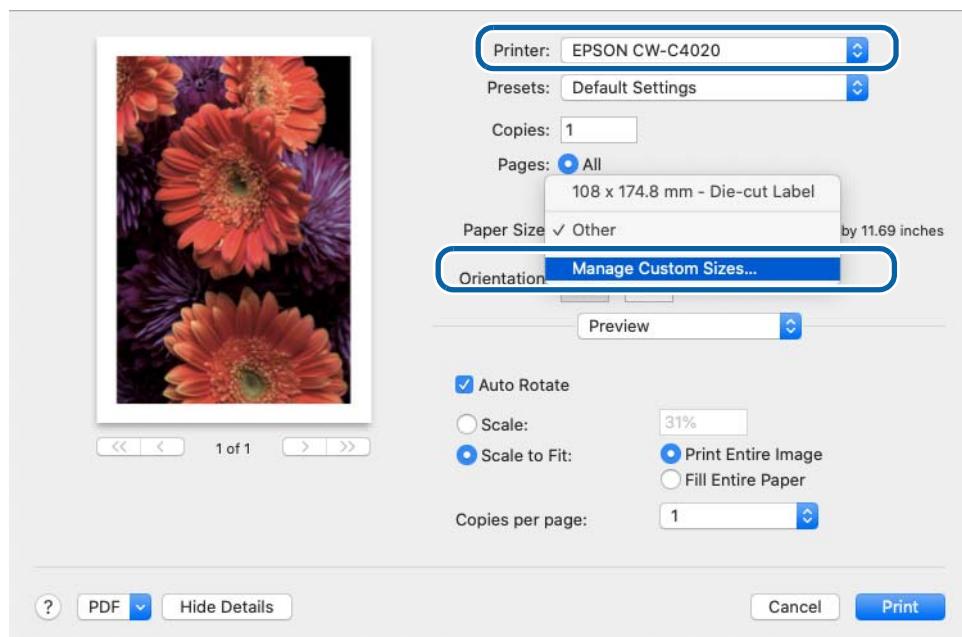

## 5 Click [+] to add a new set of paper size settings.

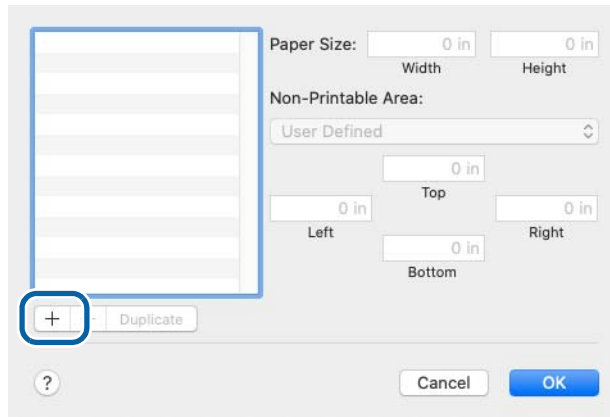

## 6 Enter paper size and make the margin setting of the printer.

Paper Size: Enter label (page) size..

Non-Printable Area: Enter "0" in all the left, right, top and bottom fields.



### IMPORTANT

The paper size set in the Mac driver may not match the paper size displayed on the operation panel of the printer.

Example 1) When printing 15.0 mm width labels from Mac driver

- Setting value for width (Mac driver): 15.0 mm
- Setting value for width (operation panel): 14.8 mm

Example 2) When printing 212.0 mm height labels from Mac driver

- Setting value for height (Mac driver): 212.0 mm
- Setting value for height (operation panel): 211.7 mm

If setting the paper size, check the value displayed on the operation panel first.

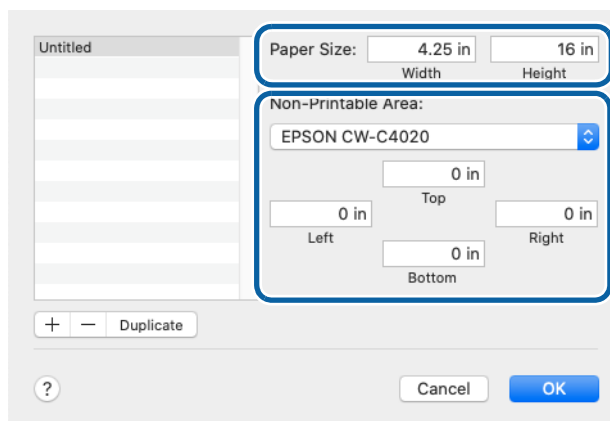

## 7 Click [Untitled] and enter a name for the custom size, and then click [OK].

The new paper size is applied to the printer driver.

## 8 Change the other settings to make them suitable for your label paper.

The following introduces setting menus that are unique to the printer. For the explanation of the other menus, refer to the Help.



- To change the paper source setting of the printer, change it using Epson Label Printer Utility. ("[Epson Label Printer Utility](#)" on page 178)
- You can change the default [Media Coating Type] setting of the printer driver following the procedure below.
  1. From the Apple menu, select [System Preferences] - [Printers & Scanners].
  2. Select the printer, and then click [Options & Supplies] - [Option].
  3. Change the setting.
- If setting menus described here are not displayed in the list, the dedicated printer driver for this printer has not been added.  
Add the dedicated printer driver following the procedure in "[Selecting the Dedicated Printer Driver](#)" on page 175.

### 1 Print Settings

Select the type of paper you use. For the other settings, refer to the Help.

Print Settings

Width: 4.25 inch  
Length: 6.00 inch

Media Coating Type: Matte Paper

Print Quality: Normal

Bidirectional Printing

Media Saving: No Saving



### CAUTION

When printing on die-cut labels, set [Media Saving] to [No Saving]. Setting to the other option may cause the print position to shift.

### 2 Color Options

This menu is enabled if you have selected [EPSON Color Controls] in the [Color Matching] menu. You can adjust color settings such as brightness and saturation. For more details, refer to the Help. For information on color correction, see "[Color Correction](#)" on page 263.

Color Options

Manual Settings  
 Off (No Color Adjustment)

▼ Advanced Settings:

Mode: Vivid colors

Brightness: 0

Contrast: 0

Saturation: 0

Cyan: 0

Magenta: 0

Yellow: 0

### 3 Extension Settings

You can change the following settings; auto cut setting, buzzer (notification) setting, pause setting, ink profile, ratio of black to composite, and ink drying time. For explanation of each setting, refer to the Help.

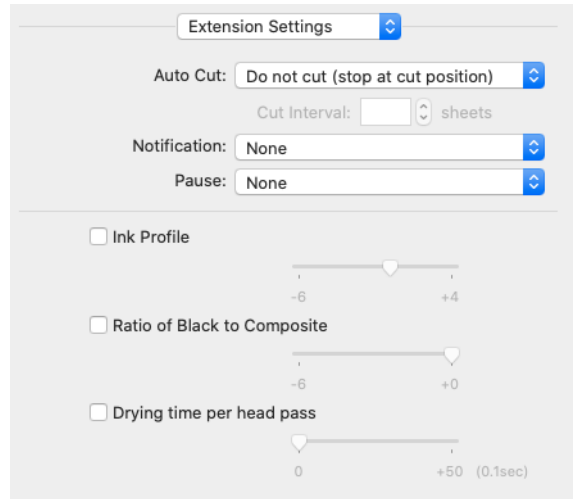

If you print without selecting the check box for [Ink Profile], [Ratio of Black to Composite], and [Drying time per head pass], those settings configured on the printer are applied. The gray out settings shown on the driver screen are not showing the actual settings, but they are default settings of the printer driver.



- You can change the driver's default setting of [Auto Cut] (the auto cutter model only), [Notification], and [Pause] following the procedure below.
  - From the Apple menu, select [System Preferences] - [Printers & Scanners].
  - Select the printer, and then click [Options & Supplies] - [Option].
  - Change the setting.
- If you increase the ratio of black ink, be careful not to touch the printed surface immediately after printing because ink can adhere to your fingers.

**9** Check the print settings, and then click [Print] to start printing.

---

## Selecting the Dedicated Printer Driver

If the menus described in “[Basic Procedure for Printing](#)” are not displayed, select the printer driver dedicate for this printer in [Printer]. The dedicated printer driver is displayed as follows.

- When connecting via USB  
EPSON CW-C4XXXX
- When connecting via a network  
EPSON CW-C4XXXX-YYYYYY  
“XXXX” is the product model number. “YYYYYY” is the last six digits of the MAC address.



Depending on the OS version, the MAC address may not be displayed even when the printer is connected via a network.

If the dedicated printer driver is not displayed in the list, add it following procedure below.

- 1** From the Apple menu, select [System Preferences] - [Printers & Scanners].
- 2** Click [+] and select [Add Printer or Scanner].
- 3** When the list of devices appears, select the dedicated printer driver and then click [Add].

## Customizing the Printer Driver

You can save frequently used sets of settings (paper size and other print settings) as Presets under a new name. This allows you to easily apply exactly the same settings repeatedly.

### Saving Settings as Preset

- 1 Make the paper size and other print settings to save them as a preset.
- 2 From the [Presets] menu, select [Save Current Settings as Preset].

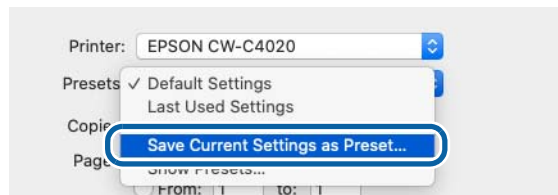

If you want the preset you last used to be selected the next time you print, open [Show Presets...] and check to make sure that the check box for [Reset Presets Menu to "Default Settings" After Printing] is not selected.

- 3 Enter a name, and then click [OK].

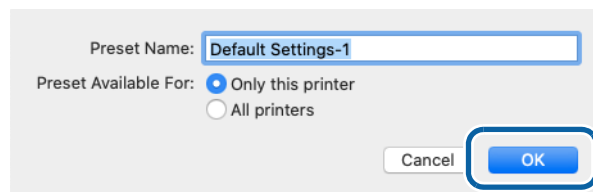

Select [All printers] in [Preset Available For] to allow selection of the preset from all printer drivers installed on your computer.

The set of settings is saved in [Presets]. You can select it from the [Presets] menu from the next time.



## Deleting from Presets

- 1 Click [Show Presets...] in [Presets] of the Print dialog box.

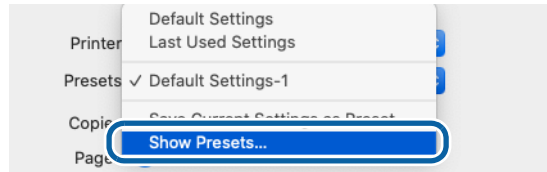

- 2 Select the preset you want to delete, click [Delete], and then click [OK].

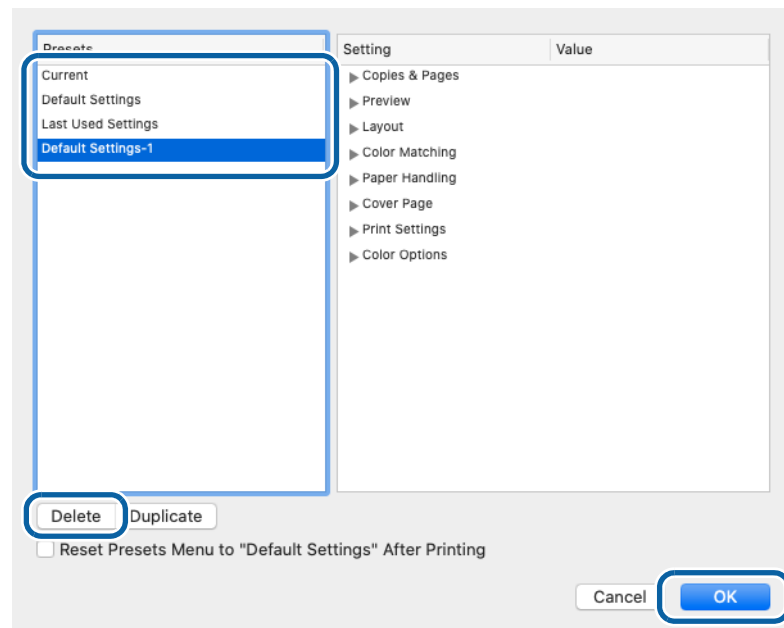

## Epson Label Printer Utility

Epson Label Printer Utility allows you to start EPSON Status Monitor, to run a nozzle check and print head cleaning, and to make adjustments. In addition, [Media Setting] and [Positioning] allow you to change those settings of the printer from the computer.

- 1 From the Apple menu, select [System Preferences] - [Printers & Scanners], and then select the dedicated printer driver for this printer.
- 2 Click [Options & Supplies] - [Utility] - [Open Printer Utility].

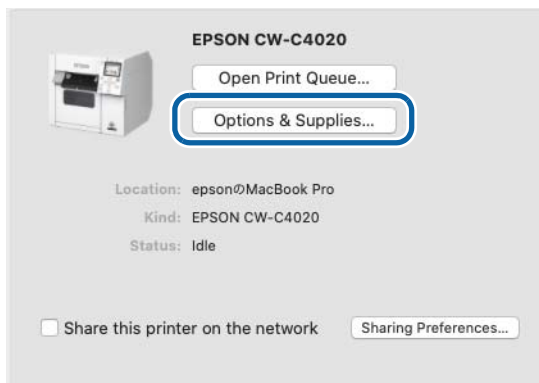

- 3 **Epson Label Printer Utility starts.**

Click an icon of the function you want to use. The function window appears. For more details, follow the instructions displayed on the window.

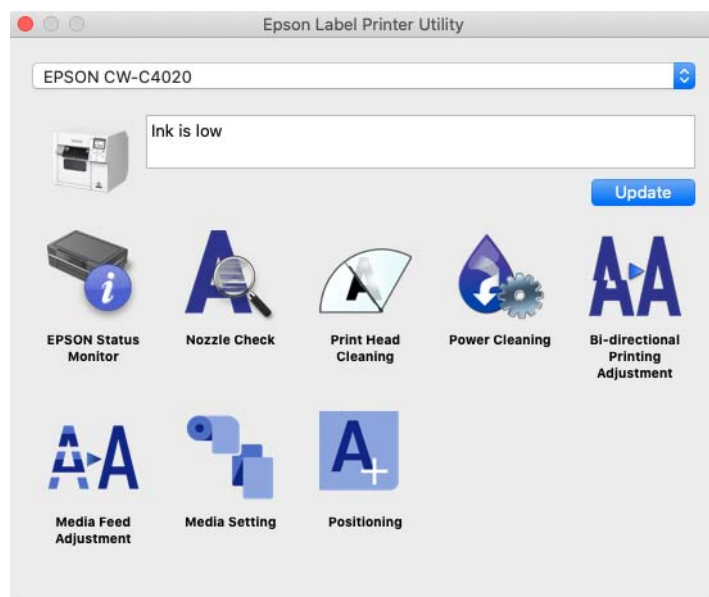

## Changing the Paper Source Setting

To change the paper source setting (internal roll or external feed), select [Media Setting] of the Epson Label Printer Utility and change the [Media source] setting.

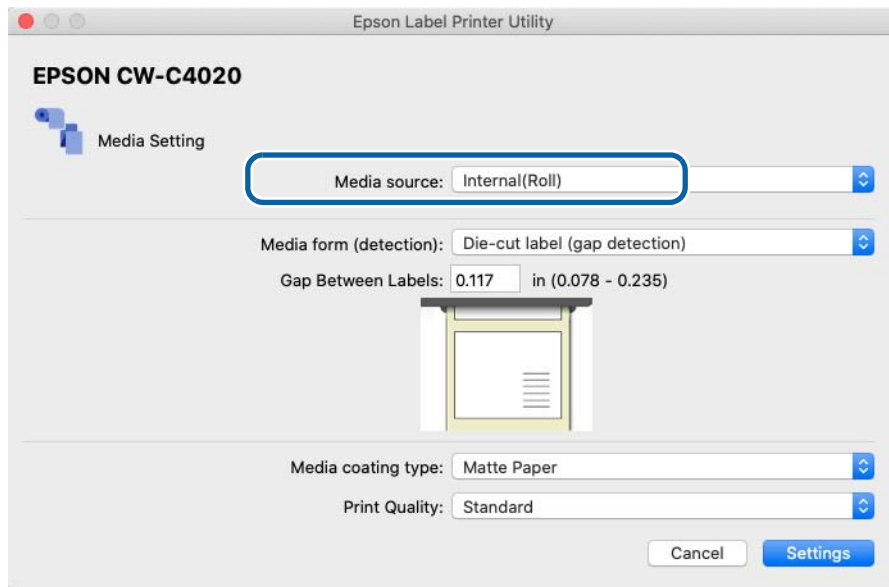

## Printer Driver for Linux

This section describes how to install the printer driver and how to configure Epson Label Printer Utility for Linux. Epson Label Printer Utility for Linux allows you to start EPSON Status Monitor, run a nozzle check and print head cleaning, and make paper settings.



### About Linux Printer Driver

- Linux driver is not for end-users. It is aimed at system developers or engineers who can build a Linux based system by themselves. To operate the driver, command lines are mainly used. Rich graphical user interface such as the Windows printer driver is not provided.
- It offers minimum functions for printing.
- Basically, the same functions as Mac printer driver are provided except for some functions that cannot be achieved due to Linux OS restrictions.

The work procedure is as follows.

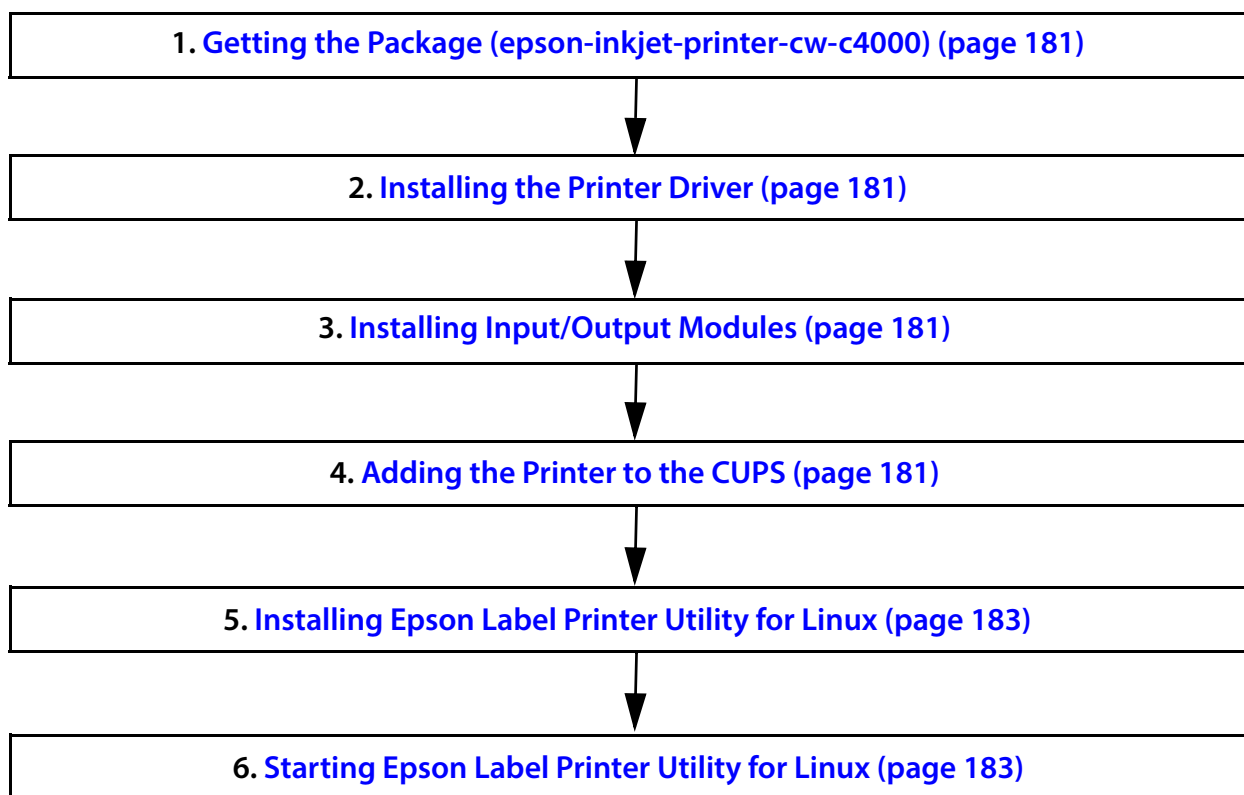

Throughout this section, command strings that follow "\$" can be executed by a login user, and command strings that follow "#" need to be executed with administrator privileges.

## Getting the Package (epson-inkjet-printer-cw-c4000)

Download the latest version of the printer driver and Epson Label Printer Utility for Linux. For details, see "[Downloading Printer Driver, Utilities, and Manuals](#)" on page 365.

## Installing the Printer Driver

Start a terminal software, and execute a command shown below.

```
< Ubuntu 20.04 LTS>
# dpkg -i epson-inkjet-printer-cw-c4000_[Arch].deb
<CentOS 7>
# rpm -i epson-inkjet-printer-cw-c4000_[Arch].rpm
```

## Installing Input/Output Modules

Execute a command shown below.

**1.0.0** indicates version of the software. Correct it according to the file you use.

```
< Ubuntu 20.04 LTS>
# dpkg -i epson-printer-io-community-1.2.1. deb
< CentOS 7>
# rpm -i epson-printer-io-community-1.2.1.rpm
```

## Adding the Printer to the CUPS

The following is the procedure using a web browser.

- 1 Access the address below.**  
<http://localhost:631/>

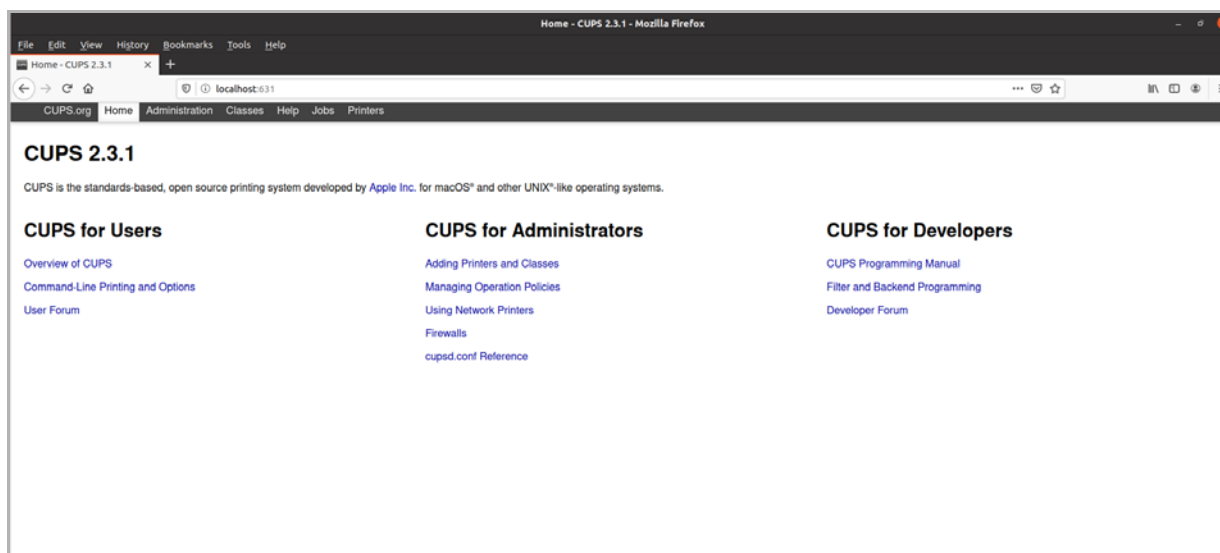

## 2 Select the [Administration] tab, and then select [Add Printer].

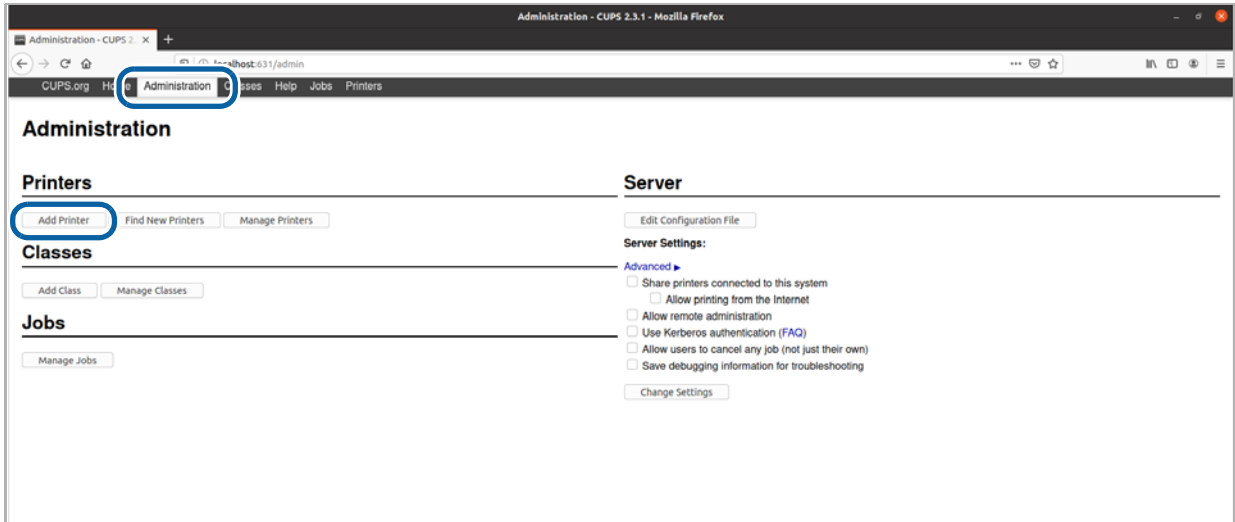

Follow the on-screen instructions. If you are prompted to enter a user name and password, enter “root” as a user name and enter an administrative password.

## 3 When a list of printers is displayed, select the printer to add.

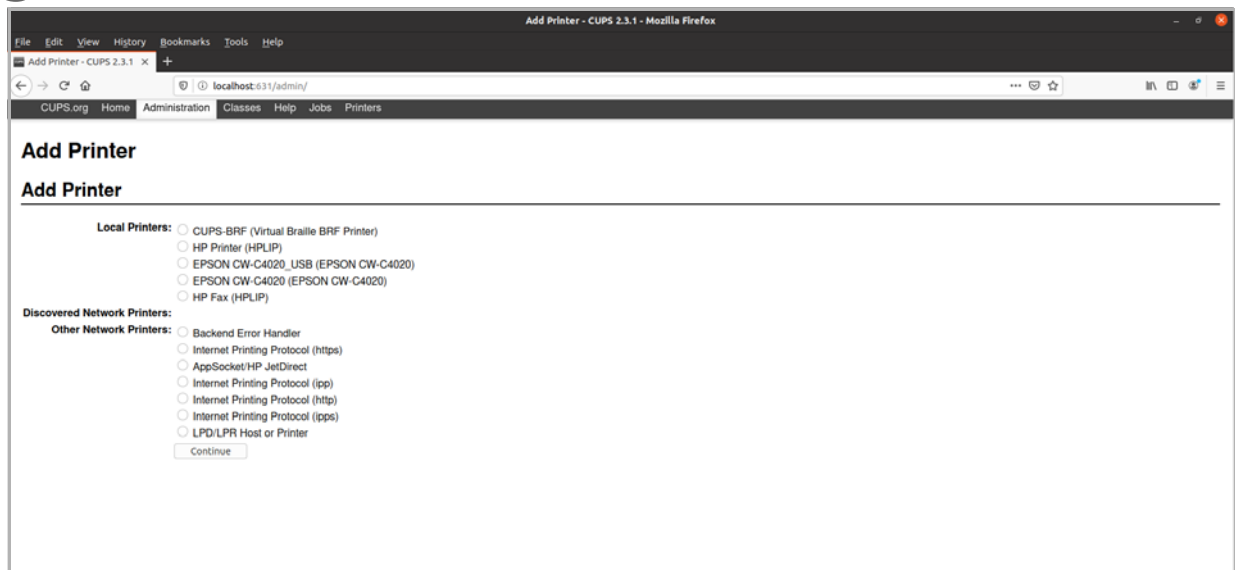

Select the [Printers] tab to see the information of the added printer.

### For USB connection

If the printer is connected to the computer using a USB cable, select the printer as described below.

In the list of printers, select the printer that is indicated with its model name followed by “\_USB” (1).

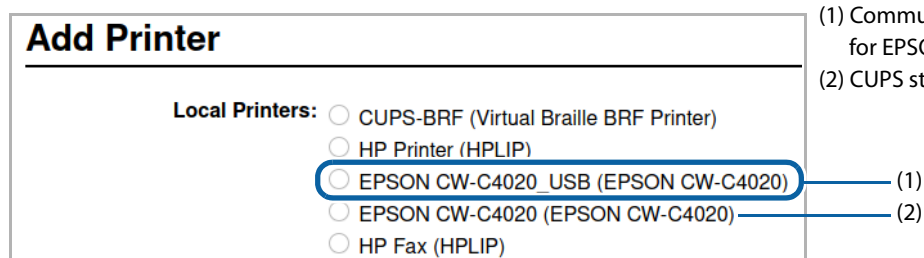

(1) Communication module  
for EPSON product  
(2) CUPS standard

## Installing Epson Label Printer Utility for Linux

Execute a command shown below.

**1.3.0** indicates version of the software. Correct it according to the file you use.

< Ubuntu 20.04 LTS>

```
# dpkg -i epson-label-printer-utility-community-1.3.0-QT5.deb
```

< CentOS 7>

```
# rpm -i epson-label-printer-utility-community-1.3.0-QT5.rpm
```

## Starting Epson Label Printer Utility for Linux

Epson Label Printer Utility for Linux can be started either from a command line or from Desktop Entry.

Use one of the following methods to start the utility.

### Starting from a command line

Execute a command shown below.

<Common to both Ubuntu and CentOS>

```
$ /opt/epson/epson-label-printer-utility/elpuqt &
```

### Starting from Desktop Entry

The operation method may vary by distribution, edition, flavors, and version.

The following explains how to start the utility on Ubuntu 20.04 LTS and CentOS 7.

<Ubuntu 20.04 LTS>

Click the icon in the bottom left of the screen, and then select Epson Label Printer Utility in the displayed list. If the utility is not displayed, search for “Epson” to find it.

<CentOS 7>

From the application menu located in the upper left of the screen, select the “Accessories” sub menu. Select Epson Label Printer Utility from the displayed list.

Epson Label Printer Utility for Linux will start.

Click an icon to display the function screen. For details, see the descriptions shown on the function screen.

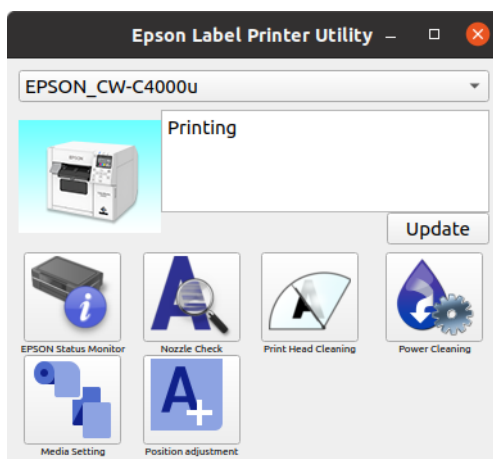

## Installing Dependent Libraries

If you are using supported distribution and have not changed the default settings, installing dependent libraries is not necessary. If you have not installed default full package, Epson Label Printer Utility for Linux may not work due to lack of dependent libraries.

The dependent libraries and the required package are as follows.

Dependent file	Dependent package (Ubuntu 20.04 LTS)	Dependent package (CentOS 7)
libQtCore.so.5	libqt5core5a	qt5-qtbase
qt5-qtbase	libqt5gui5	qt5-qtbase-gui
libQtWidgets.so.5	libqt5widgets5	
libcups.so.2	libcups2	libcups2
libcupsimage.so.2	libcupsimage2	
libpng15.so.15	(Not used)	libpng15
libpng16.so.16	libpng16-16	(Not used)
libusb-1.0	libusb-1.0-0	libusb

If an error occurs due to lack of dependent libraries when starting Epson Label Printer Utility for Linux, install the necessary file.

Example: Qt5 is not found on Ubuntu 20.04 LTS

Execute a command shown below.

```
# apt install libqt5widgets5
```

## Exiting Epson Label Printer Utility for Linux

Use one of the following methods to exit the utility.

- Click “X” on the screen.
- Press [Alt] and [F4] at the same time.
- Click [Exit Epson Label Printer Utility].

## Uninstalling Printer Driver, Epson Label Printer Utility for Linux

### ❑ Printer driver

Start a terminal software, and execute a command shown below.

< Ubuntu 20.04 LTS >

```
# dpkg -P epson-inkjet-printer-cw-c4000
```

< CentOS 7 >

```
# rpm -e epson-inkjet-printer-cw-c4000
```



#### ❑ Epson Label Printer Utility for Linux

Start a terminal software, and execute a command shown below.

< Ubuntu 20.04 LTS>

```
# dpkg -P epson-label-printer-utility-community
```

```
# dpkg -P epson-printer-io-community
```

< CentOS 7>

```
# rpm -e epson-label-printer-utility-community
```

```
# rpm -e epson-printer-io-community
```



## Printing from SAP System

There are three types of printing methods from the SAP system, which is one of the ERP (Enterprise Resource Planning) systems: Direct printing, Indirect printing, and High Volume printing. This product supports the two printing methods, Indirect printing and High Volume printing, and does not support Direct printing, which is the standard printing method for SAP systems. If you want to print with Direct printing, please use CW-C6000/C6500 Series.

### Methods of Printing from SAP System

There are the following three methods to print from SAP System.

To know the data flow and component of each methods, see ["SAP System Printing Data Flow" on page 187](#).

Printing Method	Overview
Indirect printing  <a href="#">"Indirect Printing" on page 188</a>	Printing operation is completed through a Windows computer located outside the SAP system. Sprint or SAP LPD software provided by SAP company installed on the Windows computer receives print data from the SAP system, converts the data into Windows print system format, and then prints the data by sending it to a Windows printer driver provided by the printer vendor. Therefore, this method allows you to print on various Windows compatible printers. However, because of using software located outside the SAP system, frequency of problem may increase or printing speed may decrease compared to Direct printing.
High Volume Printing  <a href="#">"High Volume Printing" on page 188</a>	This method is for printing GHS labels that contain color pictograms. The data is sent from EHS (Environment, Health and Safety Management) and GLM (Global Label Management) and printed through WWI (Windows Word processor Integration) Server. HVP driver provided by SAP company is used, and for specifying the target printer, plug-in provided by the printer vendor is used. The amount of data for printing is smaller than that for normal Windows printer driver.
Direct printing	This product does not support this printing method. This is a standard method for printing from SAP System. Printing operation is completed in the closed SAP system environment, where basically only programs provided by SAP company are used. Printer driver provided by the system as a SAP standard printer driver is used. Since this Direct printing system is highly reliable and stable, it is generally used for remote batch high-volume printing.

### SAP System Printing Data Flow

The flowchart below shows the data flow and component of each printing methods.

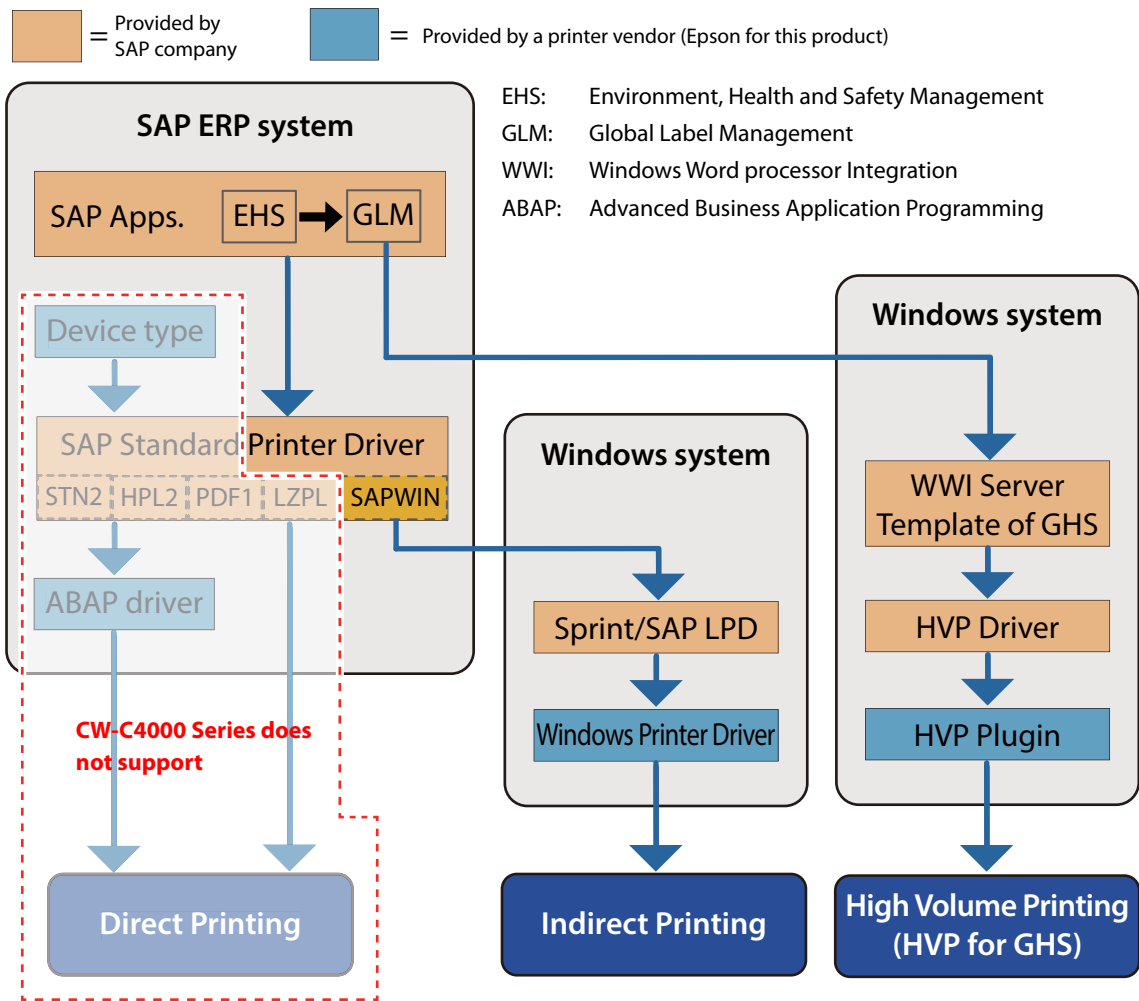

## Indirect Printing

Install the latest Epson Windows printer driver on a Windows computer for using this method.

For instructions on how to use the driver, see "[Printer Driver for Windows](#)" on page 84.

For instructions on how to install and use the SAP software, Sprint or SAP LPD, follow the instructions provided by SAP company.

## High Volume Printing

This method uses HVP driver provided by SAP company. Epson provides a plug-in file for the HVP driver.

Plug-in file name: HVP Plug in for CW C40x0

For instructions on how to perform high volume printing, see "CW-C4000 Series HVP Plug in Module User's Guide" that comes with the plug-in.

## PrinterSetting (Windows)



You may not be able to change the settings while the printer driver or other software is communicating with the printer.

PrinterSetting is a utility that allows you to configure the printer settings. The following shows a summary of available settings with PrinterSetting.

Item	Description	Page
Media settings*	Allows you to make settings of paper to be used on the printer.	<a href="#">Page 192</a>
Layout settings*	Allows you to make paper layout settings. User-defined layout settings that include paper form and print area setting can be configured.	<a href="#">Page 193</a>
Position adjustment	Allows you to adjust print start position and cut position.	<a href="#">Page 195</a>
Print results adjustment*	Allows you to adjust colors and barcode.	<a href="#">Page 197</a>
Store data in the printer	Allows you to register images, templates, and fonts to the printer. In addition, a character code can be selected from the character code table.	<a href="#">Page 198</a>
Background image settings*	Allows you to configure a background image.	<a href="#">Page 202</a>
Print head maintenance	Allows you to run a print head cleaning or nozzle check, and make settings for periodic cleaning.	<a href="#">Page 206</a>
Detailed settings	Allows you to make detailed settings of the printer. <ul style="list-style-type: none"> <li>• Printer settings</li> <li>• Print head alignment</li> <li>• Panel settings</li> <li>• Operating time settings</li> <li>• Nozzle check settings</li> <li>• Advanced settings</li> <li>• Initialize printer</li> </ul>	<a href="#">Page 207</a> to <a href="#">Page 225</a>
Printer information	Allows you to check the printer settings such as paper settings and layout settings, and the maintenance counter.	<a href="#">Page 226</a>
Settings save and restore	Allows you to save the printer settings and to restore the settings from the saved file.	<a href="#">Page 228</a>
Option	Allows you to change PrinterSetting preferences. A unit of length used in PrinterSetting and start up setting can be changed.	<a href="#">Page 229</a>

\* Not displayed if you start PrinterSetting from the printer driver.

## How to Start PrinterSetting

Start PrinterSetting by following the steps below.

- 1** Turn the printer on.
- 2** Click [Start] - [EPSON] - [CW-C4000 PrinterSetting].
- 3** The Select printer window appears. Select a search target, and then click [Search].

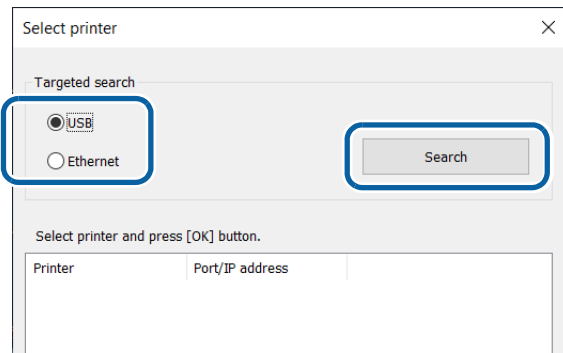

- 4** The printer is displayed in the list. Select the printer, and then click [OK].

 If the printer is connected via Ethernet, the printer may not be displayed in the list. In that case, enter an IP address of the printer.

The screenshot shows the 'Select printer' dialog box with the 'Ethernet' radio button selected. Below the search options, there is a table with two columns: 'Printer' and 'Port/IP address'. The table is currently empty. At the bottom of the dialog box, there is an 'IP address:' label and a text input field containing the IP address '192 . 168 . 192 . 168'. The 'OK', 'Cancel', and 'Help' buttons are visible at the bottom of the dialog box.

## 5 PrinterSetting is started.

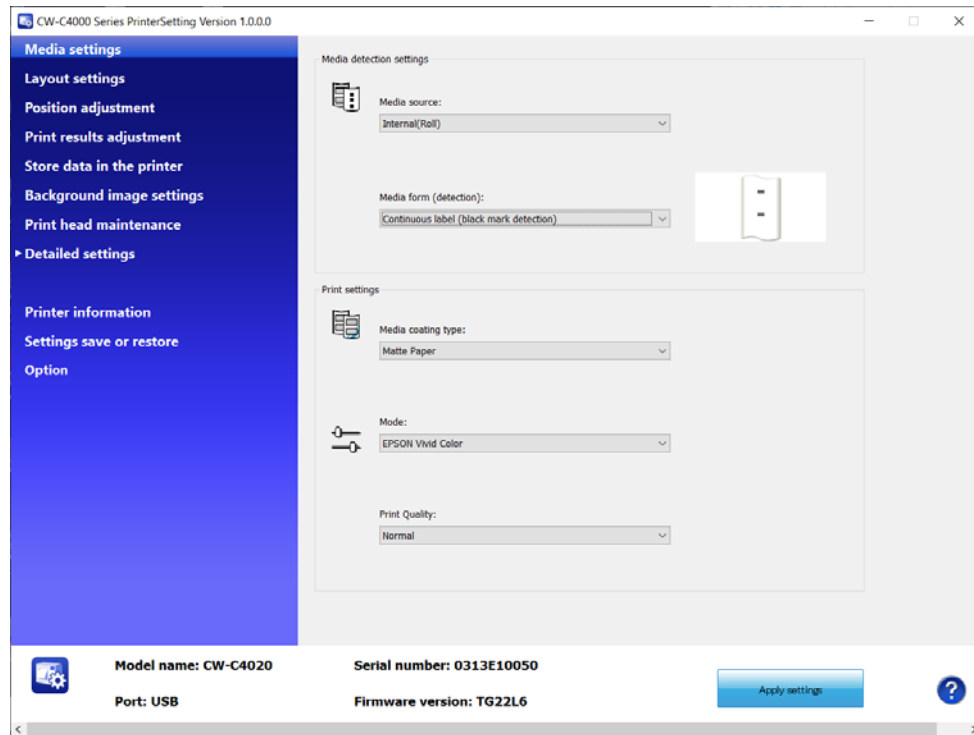

### How to Apply Settings

After you change the printer settings, click [Apply settings] to apply the changes to the printer.

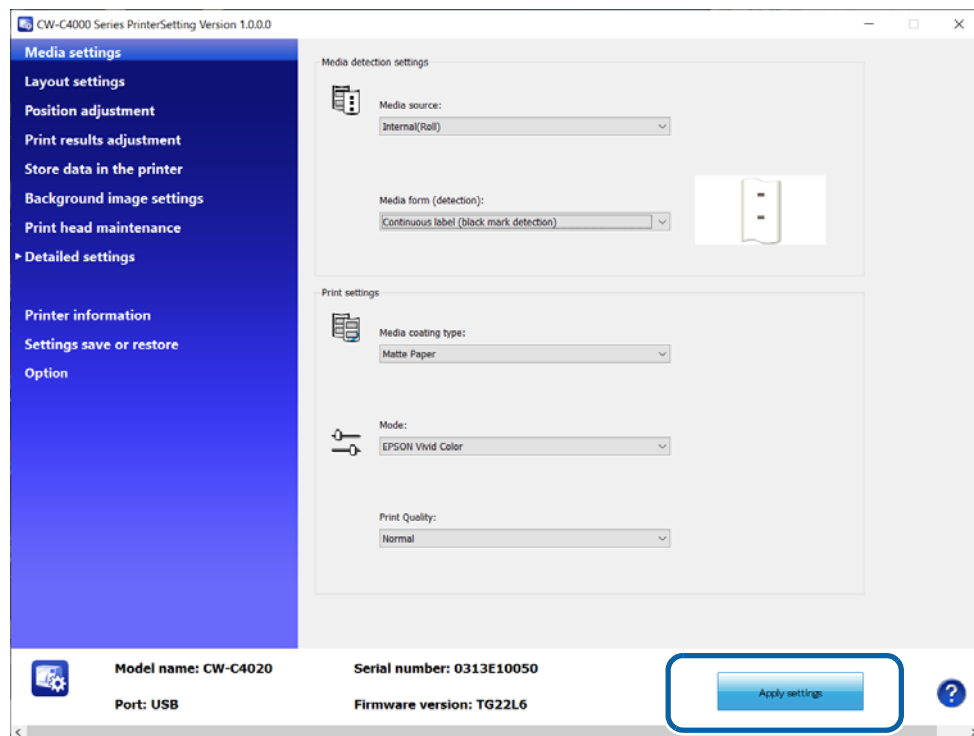

## Media settings

Allows you to make settings of paper to be used on the printer.



This is not displayed if you start PrinterSetting from the printer driver.

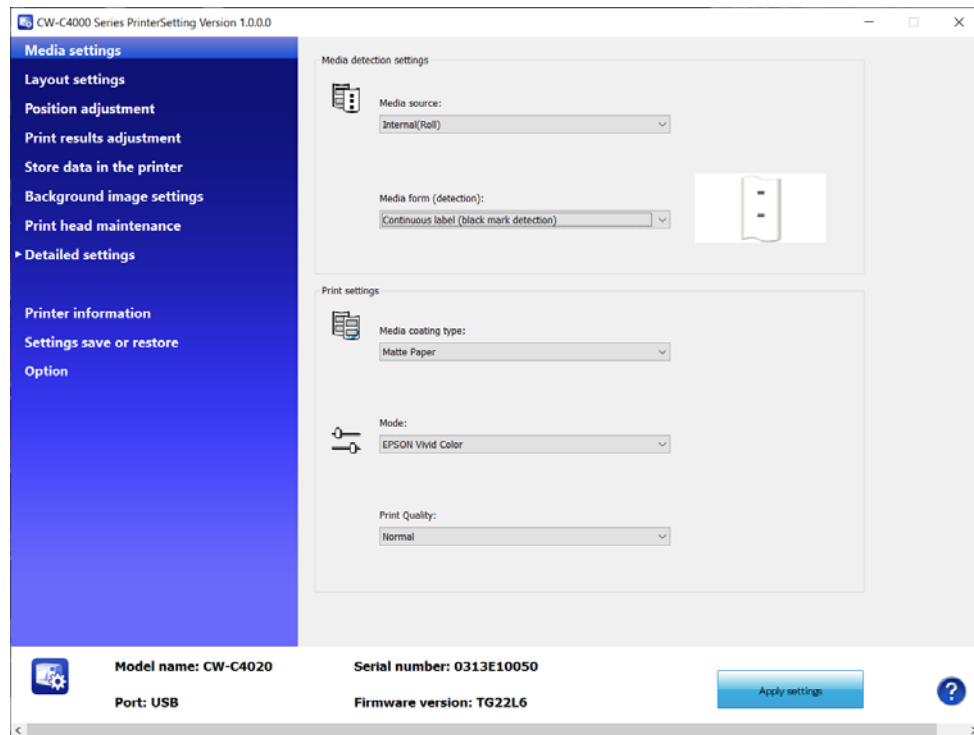

Item		Description
Media detection settings	Media source	Allows you to change the paper feed setting.
	Media form (detection)	Allows you to set paper detection setting.
Print settings	Media coating type	Allows you to select a paper type.
	Mode	Allows you to select the color correction method.
	Print Quality	Allows you to select the print quality.



- You cannot select [Mode] and [Print Quality] unless you select [Media coating type].
- [Epson Preferred Color] in [Mode] may not be available depending on the combination of [Paper Type] and [Print Quality] settings. For details, see ["Restrictions when using Epson Preferred Color" on page 265.](#)



## Layout settings

Allows you to change the paper layout settings and create a user-defined layout settings.



This is not displayed if you start PrinterSetting from the printer driver.

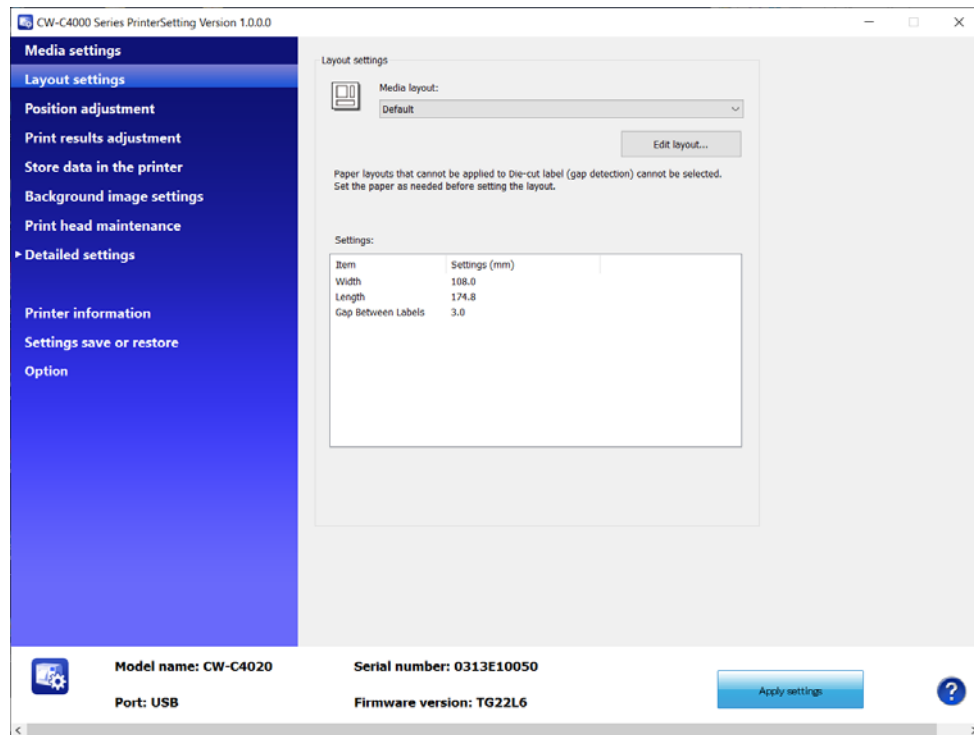

Item		Description
Layout settings	Media layout	Allows you to make paper layout settings.
	Edit layout...	Allows you to create a user-defined layout settings. The Layout settings window appears when you click this.

## Layout settings

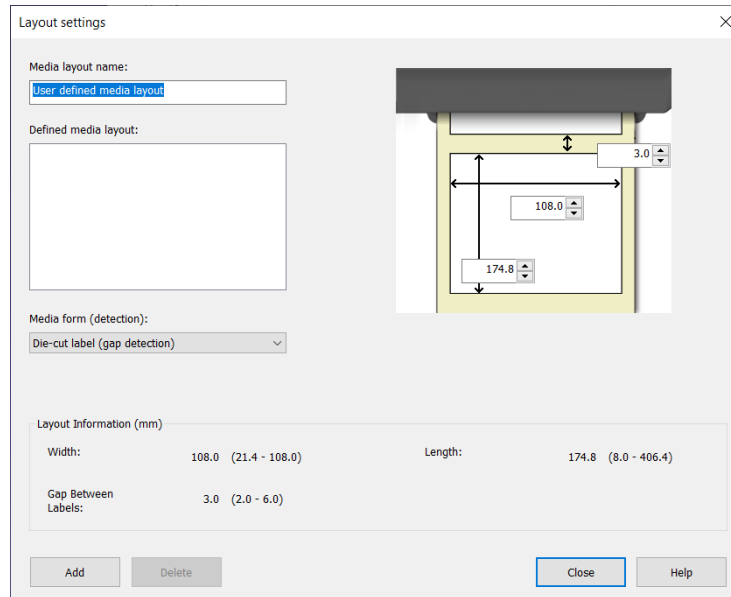

Layout settings

Media layout name:  
User defined media layout

Defined media layout:

Media form (detection):  
Die-cut label (gap detection)

Layout Information (mm)

Width:	108.0 (21.4 - 108.0)	Length:	174.8 (8.0 - 406.4)
Gap Between Labels:	3.0 (2.0 - 6.0)		

Add Delete Close Help

Item	Description
Media layout name	Allows you to set a name for a new paper layout settings. Enter a name to set.
Defined media layout	If one or more sets of user-defined paper layout settings already exist, they are listed here.
Media form (detection)	Allows you to select a media form.
Layout Information	Allows you to specify a width, length,, and a gap between labels. Available setting items in [Layout Information] varies by media form. Before setting [Layout Information], select the media form.



When label (page) length is long, length of printed image may be shorter than the specified length depending on paper used. It causes an extra margin on the bottom of the label (page) (bottom means rear end in the paper feed direction). If you want to reduce the margin, try the following method.

Step 1: Examine print results on labels.

Step 2: Add the length of the extra margin to the length in Layout settings.

## Position adjustment

Allows you to adjust print start position and cut position.

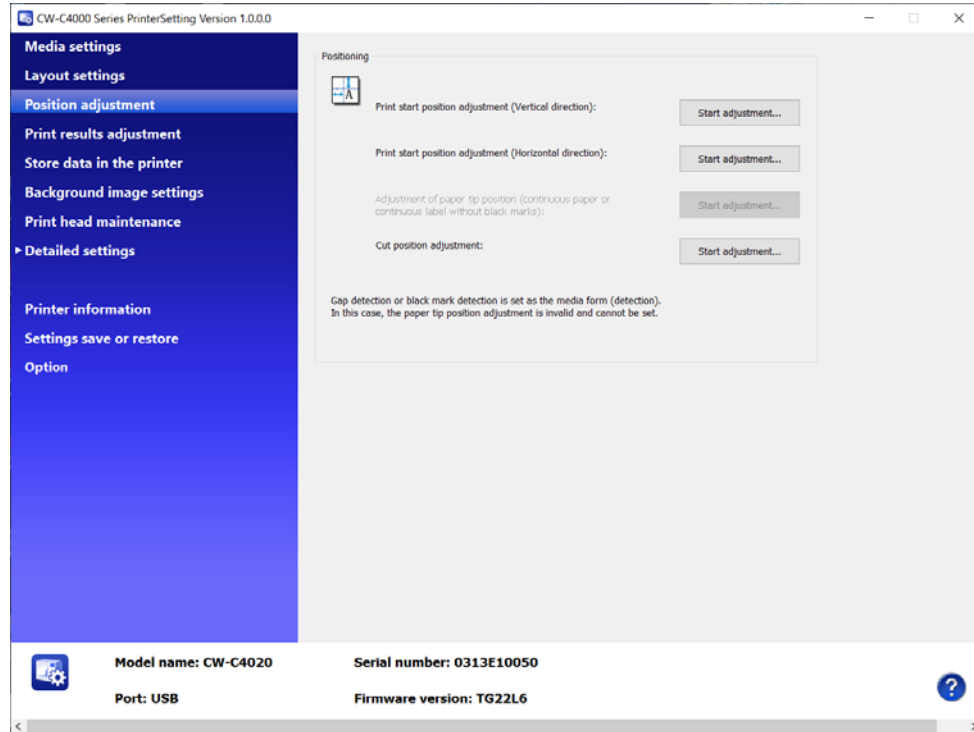

Item		Description
Positioning	Print start position adjustment (Vertical direction)	Allows you to adjust the print start position in the vertical direction. Adjustment procedure <a href="#">"Start adjustment" on page 196</a>
	Print start position adjustment (Horizontal direction)	Allows you to adjust the print start position in the horizontal direction. Adjustment procedure <a href="#">"Start adjustment" on page 196</a>
	Adjustment of paper tip position (continuous paper or continuous label without black marks)	Allows you to adjust the print start position from the leading edge of continuous paper or full-page label. Adjustment procedure <a href="#">"Start adjustment" on page 196</a>
	Cut position adjustment	Allows you to adjust the cut position. Adjustment procedure <a href="#">"Start adjustment" on page 196</a>

## Start adjustment

- 1 **The window shown below appears when you click [Start adjustment].**  
(The window is of Print start position adjustment (Vertical direction).)

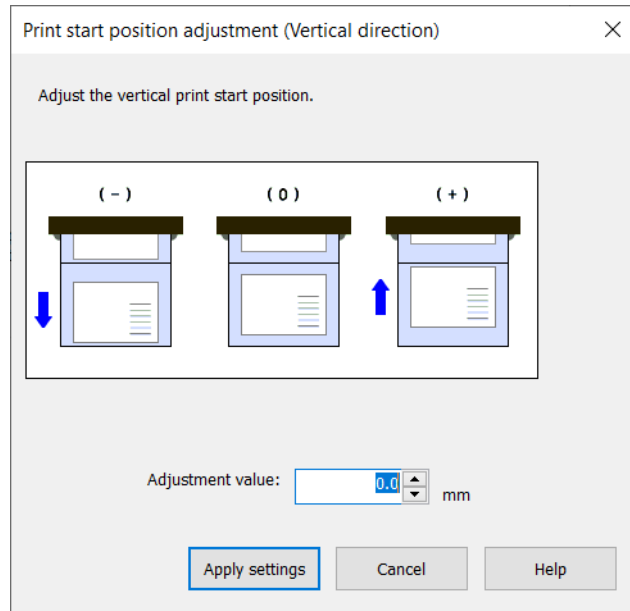

- 2 Enter a value in the [Adjustment value] box, and then click [Apply settings].
- 3 A confirmation window appears. If you click [Yes], the change is applied.

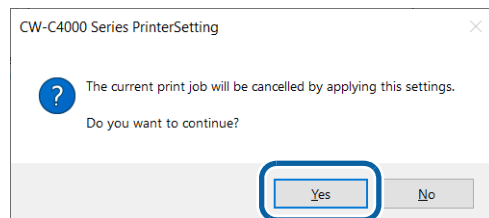

- 4 The result is displayed. Click [OK].
- 5 Print on some labels to check the position is corrected as intended.

## Print results adjustment

Allows you to adjust colors and barcode.



This is not displayed if you start PrinterSetting from the printer driver.

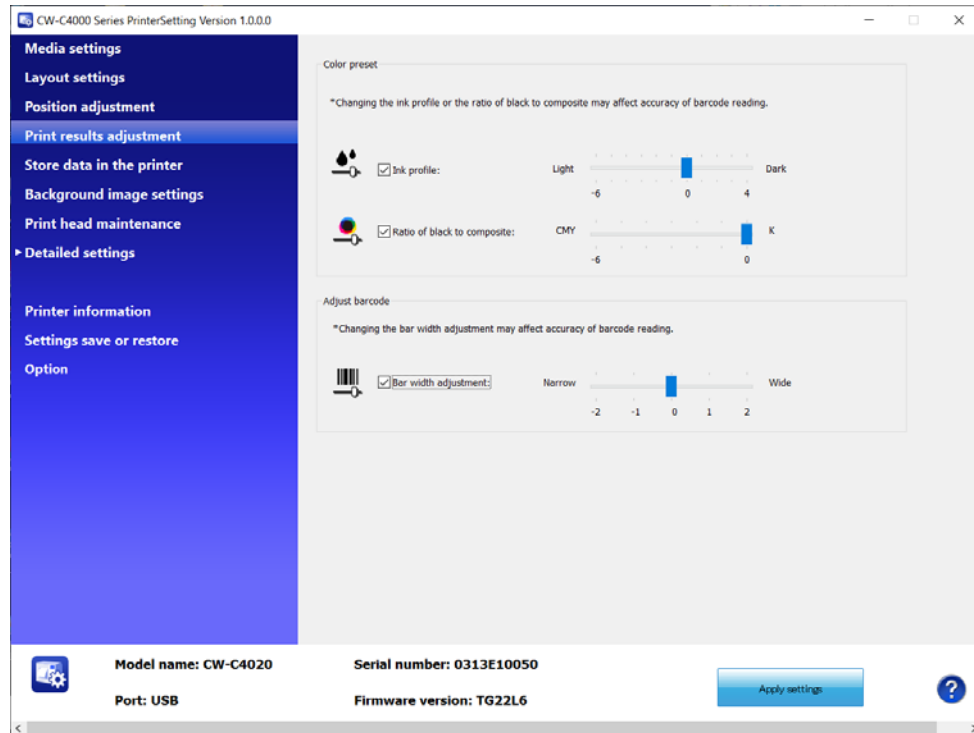

Item		Description
Color preset	Ink profile	Allows you to adjust print density. To ensure print quality, adjust this when you change paper.
	Ratio of black to composite	Allows you to set the ratio of black to composite.
Adjust barcode	Bar width adjustment	When using a built-in barcode font, use this to adjust the bar width.



If you increase the ratio of black ink, be careful not to touch the printed surface immediately after printing because ink can adhere to your fingers.

## Store data in the printer

Allows you to register images, templates, fonts, character code tables, and spot colors to the printer.

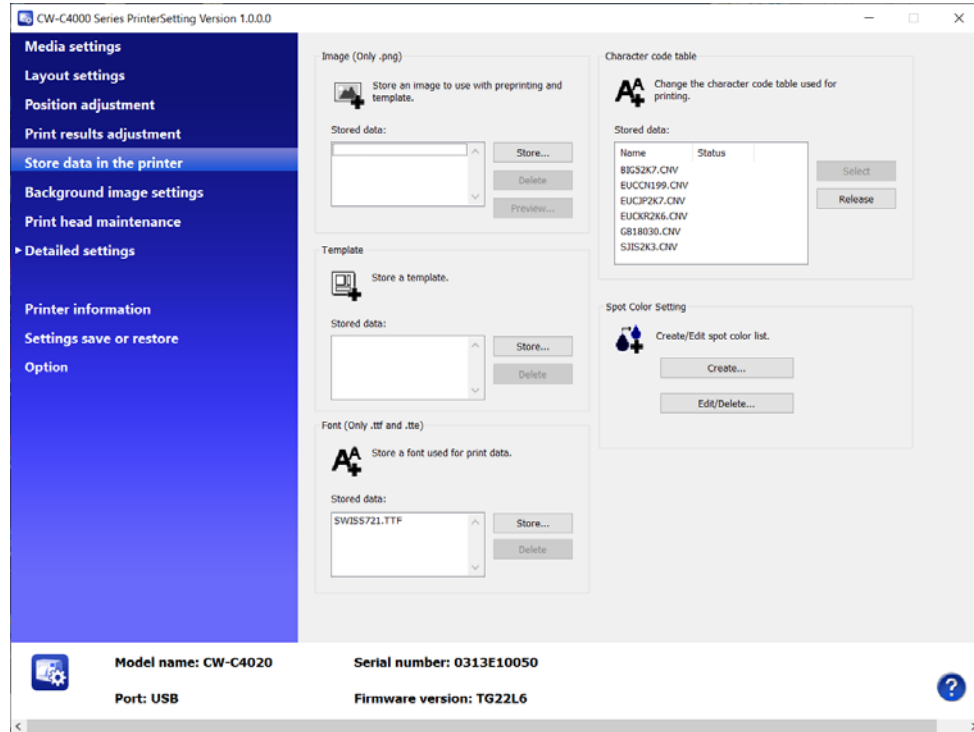

Item	Description
Image (Only .png)	You can register images to be used for preprinting or templates.
Template	Allows you to register templates.
Font (Only .ttf and .tte)	Allows you to register fonts to be used in print data.
Character code table	Allows you to register character code tables to use when printing.
Spot Color Setting	Allows you to create spot color setting files.

## Registering Images

You can register frequently used color images to the printer.

### Creating a background image

- 1 Prepare an image file in PNG format that has resolution appropriate for printing by the printer.

See "Product Specifications" on page 342.

- 2 Replace an image according to the media size.

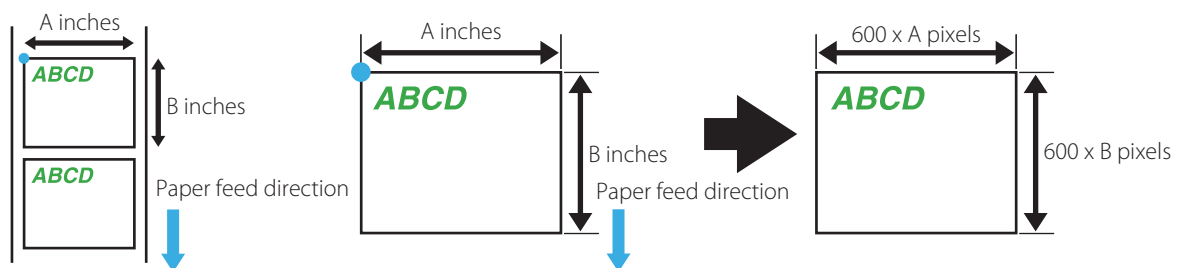

Make sure to match the resolution of the image with print resolution.

- 3 Save the image file in PNG format.

## Registering Images

Click [Store...] in the [Image (Only .png)] field to display a screen to select an image.

Specify a png image file to be stored, and then click [Set].

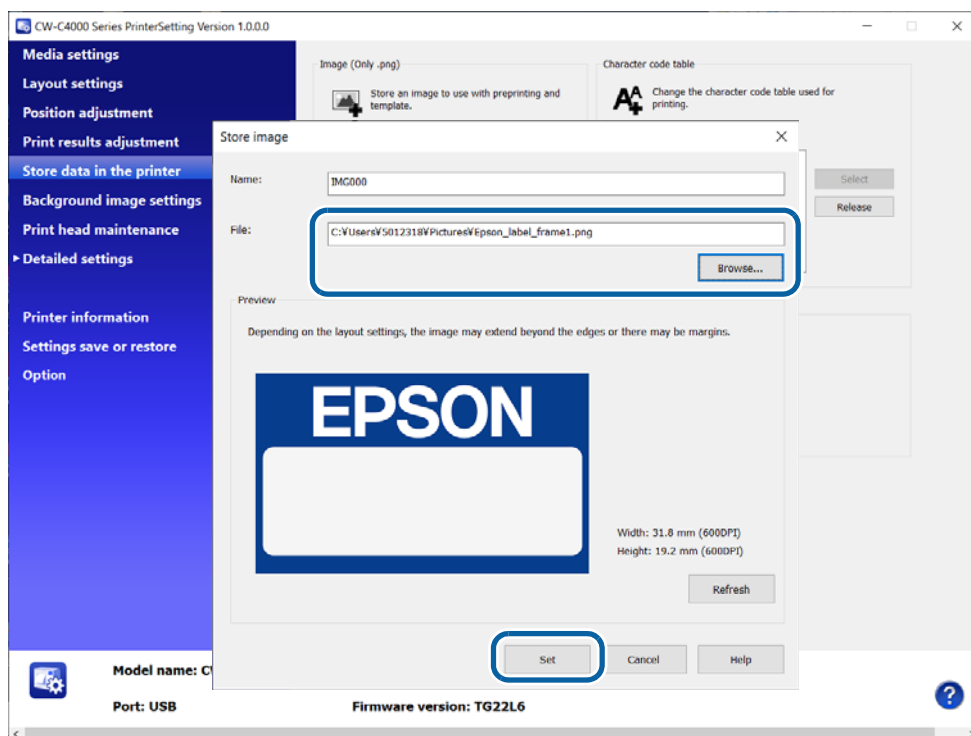

The image file is sent to the printer and stored as a background image.

## Registering Templates

The term “template” indicates a standard size label format used by an application that directly controls ESC/Label commands. Registering a template that can be used for your various labels allows your application to generate only data of variable information and print the data combining it with the registered template.

To create a template and to specify the template to print, use the ESC/Label commands.

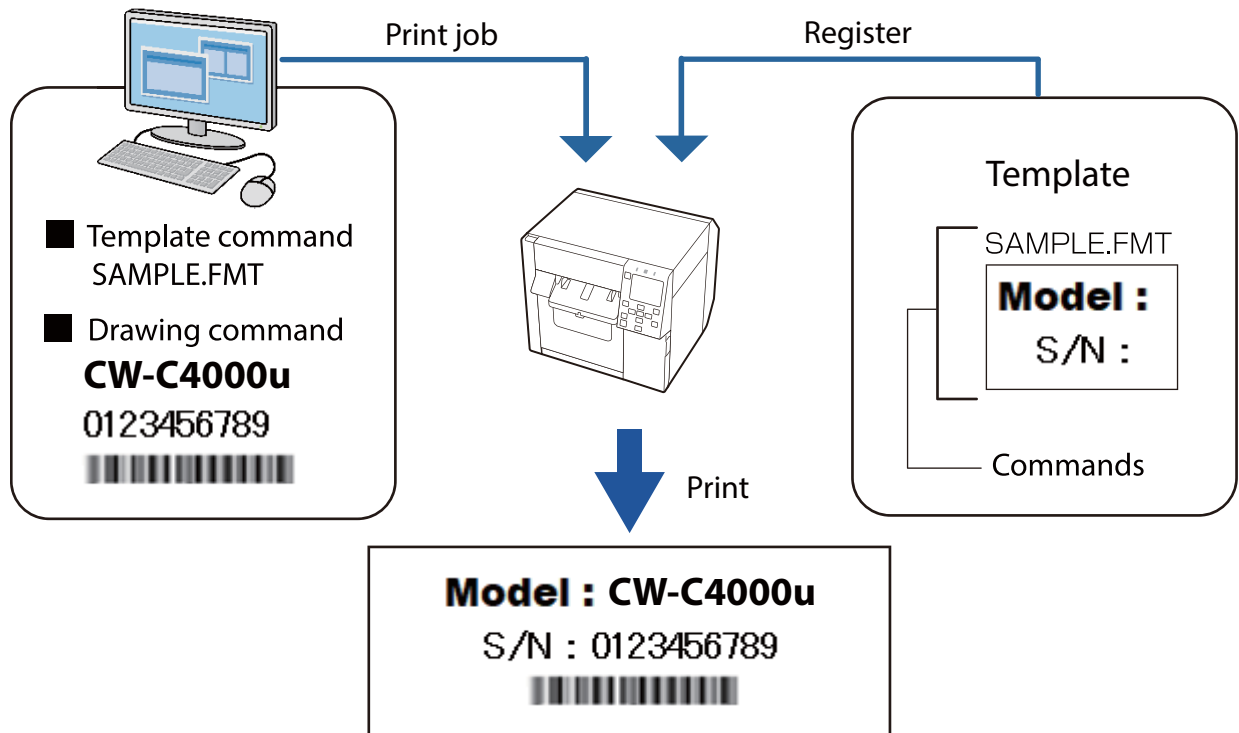

## Creating Templates

Using the ESC/Label commands, write label format to be registered on a text or binary file. In the label format description, write the file name of the template file. For more details about the commands, refer to the “Save label format” section in “ESC/Label Command Reference Guide”. There is no prescribed file extension for the text or binary file.

## Registering Templates

Click [Store...] in the [Template] field to display a screen to select a template file.

Select the text or binary file that you created as the template file, then click [Set].

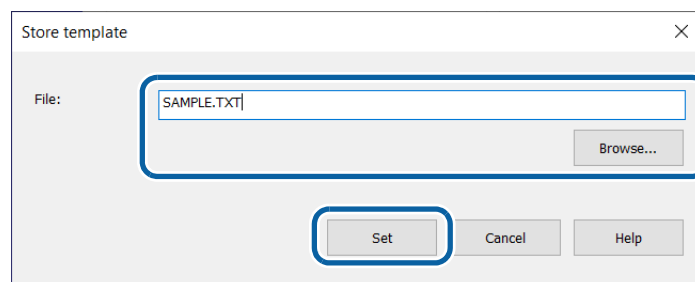

The template file is stored in the printer.



## Registering Fonts

Click [Store...] in the [Font (Only .ttf and .tte)] field to display a screen to select a font. Specify the font file (.TTF format) to be stored, and then click [Set].

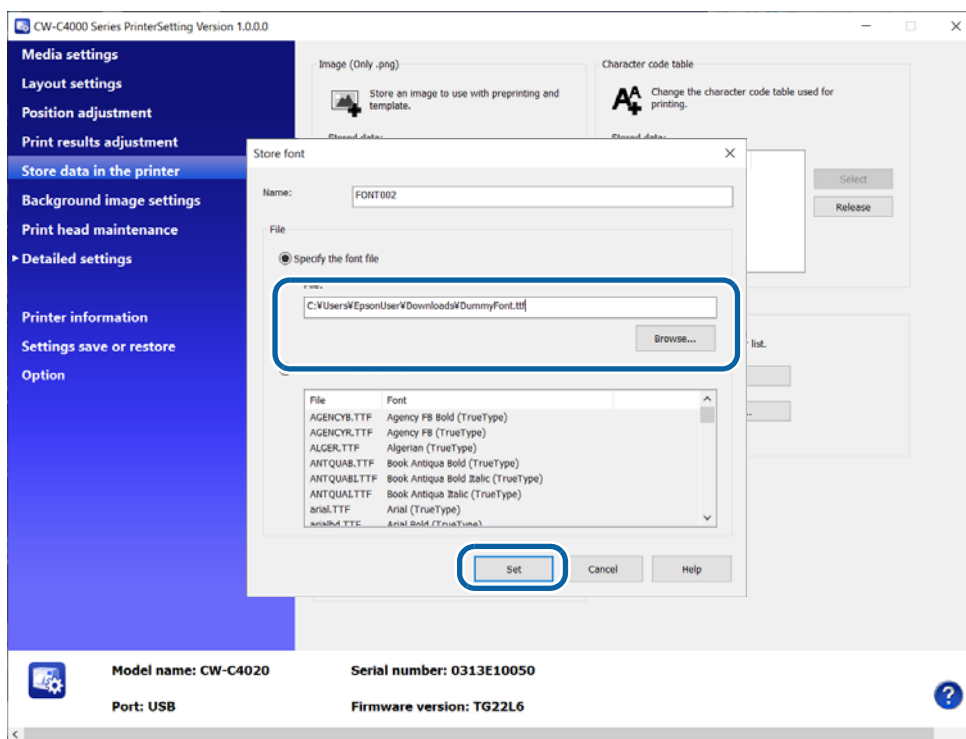

The font file is sent to the printer and stored as a built-in font.

## Setting Character Code Table

To print characters under the direct control of ESC/Label commands, you need to set character code table that corresponds to the character code you use.

Character code	language	Character code table
BIG5	Traditional Chinese	BIG52K7.CNV
EUC-CN	Simplified Chinese	EUCCN199.CNV
EUC-JP	Japanese	EUCJP2K7.CNV
KS X 1001(KS-C 5601-1987)	Korean	EUCKR2K6.CNV
GB18030	Simplified Chinese	GB18030.CNV
Shift-JIS	Japanese	SJIS2K3.CNV

Select a character code in the [Stored data:] box in the [Character code table] field, and then click [Select].



If you have replaced from a ZPL II compatible monochrome printer, a character code that CW-C4000 Series do not support may be specified and the specified character code table may not be applied. In such case, select [Advanced settings] from the [Detailed settings] menus, then select [Fix character code table] in the [Replace settings from printer using ZPL II commands] window. For details, see "[Settings for Replacing from ZPL II Compatible Monochrome Printer](#)" on page 218.

## Background image settings

Allows you to configure a background image.



- Use this function when using the following software.
  - Windows driver from Zebra Technologies Corporation
  - A commercially available label printing application that supports this printer
  - An application that directly controls ZPL II or ESC/Label commands
- This is not displayed if you start PrinterSetting from the printer driver.

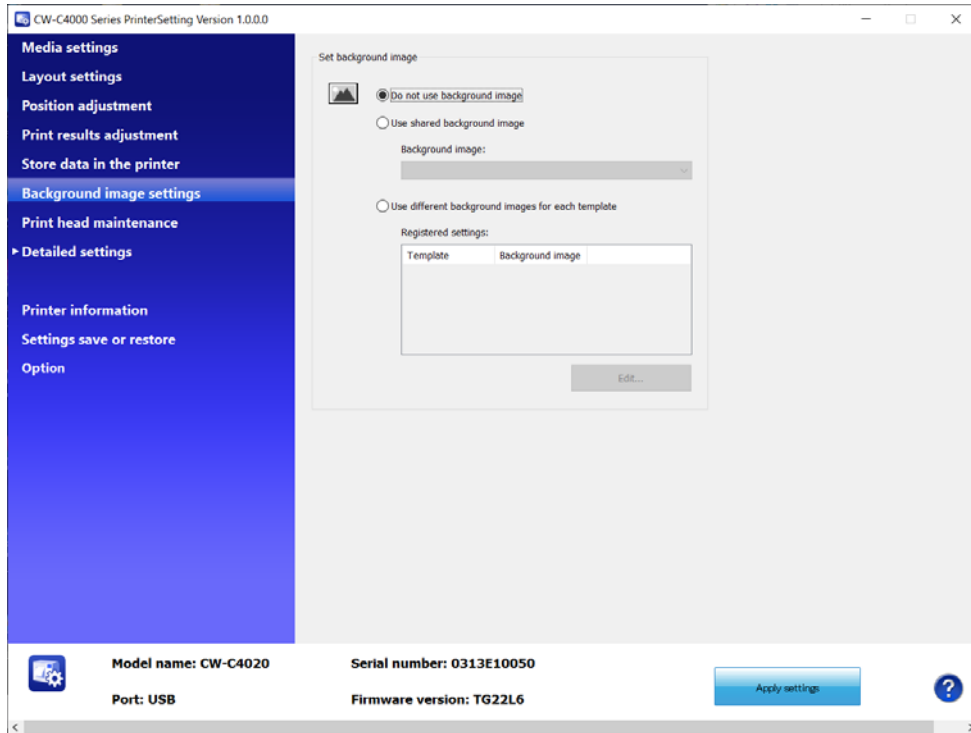

Item		Description
Set background image	Do not use background image	Select this when you do not want to print a background image.
	Use shared background image	The specified image is printed as a background image in normal printing mode. If you print using a template, the image is not printed.
	Use different background images for each template	If you print using a template, the image specified for the selected template is printed. If you do not use a template, the image is not printed.

### Printing the background image

The background image is printed with the following software.

- Windows driver from Zebra Technologies Corporation
- A commercially available label printing application that supports this printer
- An application that directly controls ZPL II or ESC/Label commands



The Epson printer driver does not support printing a background image.

## Linking the Image and the Template

CW-C4000 Series allows you to link an image to a template so that the image is printed being overlaid on the template automatically when the template is specified by an application.

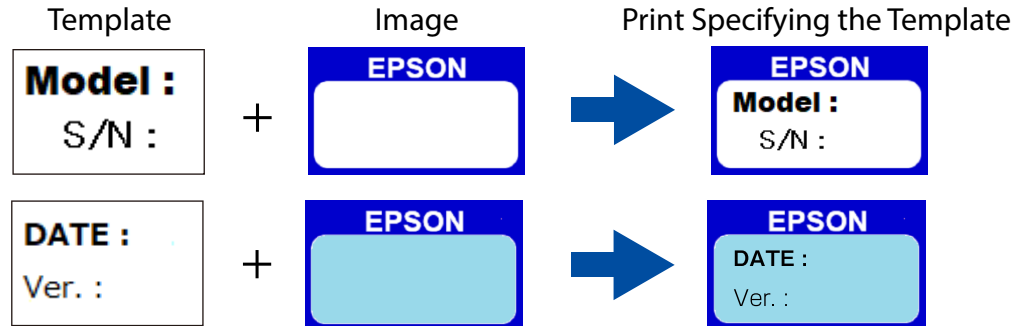

First store the image and the template data in the printer, and then make the link setting.

Store the image data: ["Registering Images" on page 199](#)

Store the template data: ["Registering Templates" on page 200](#)

When you have finished storing the data, make the link setting.

In the [Set background image] field, select [Use different background images for each template], and then click [Edit...].

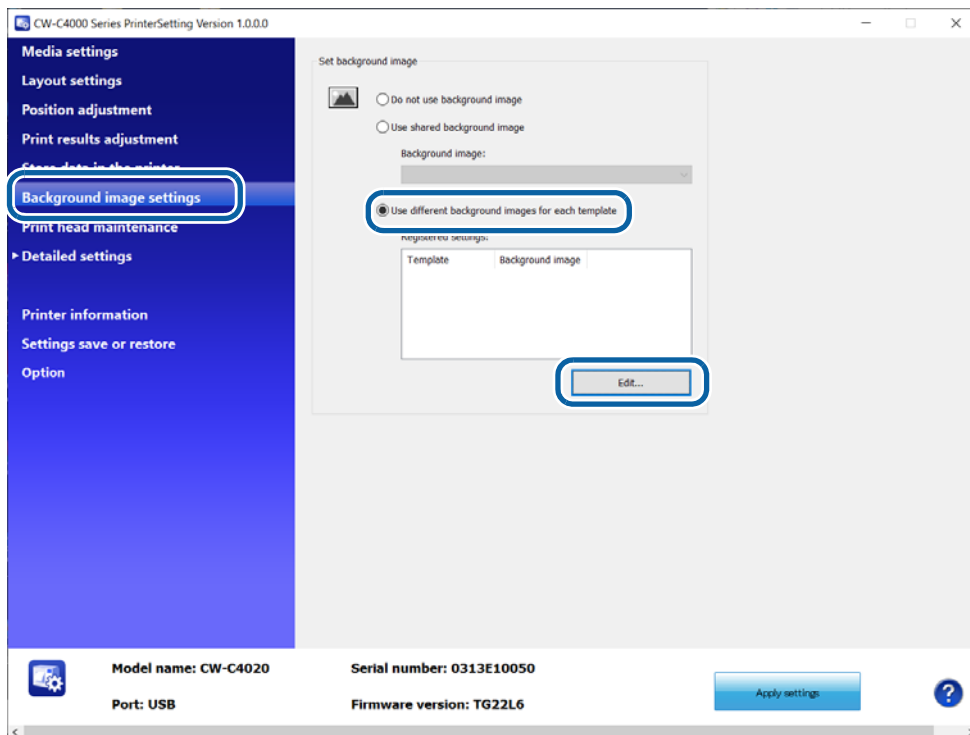

In the [Background image for each template] window, select a template and an image to be linked to the template, and then click [OK]. The link setting is set to the printer.

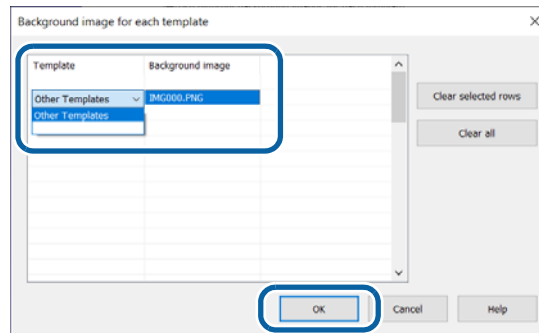

## Print head maintenance

Allows you to run a print head cleaning or nozzle check, and make settings for periodic cleaning.

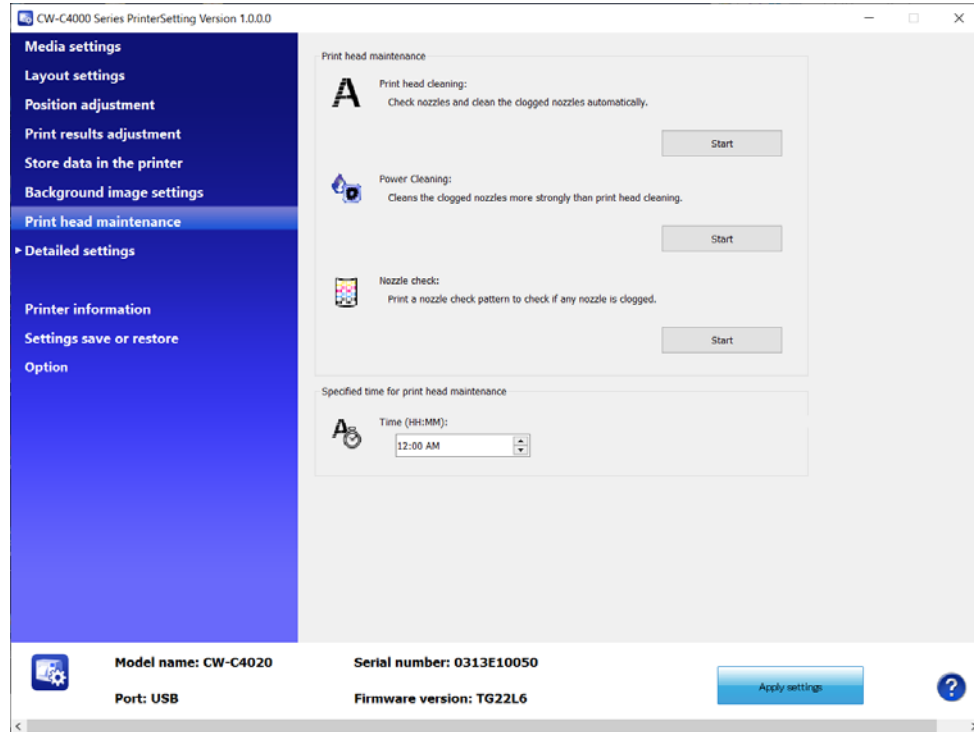



Item		Description
Print head maintenance	Print head cleaning	Runs a nozzle check and clears nozzle clogging. Click [Start] to run the cleaning.
	Power Cleaning	Clears nozzle clogging by running a cleaning that is more powerful than [Print head cleaning]. Click [Start] to run the cleaning.
	Nozzle check	The nozzle check patterns are printed to allow you to check print nozzles for clogging. Click [Start] to print the nozzle check pattern.
Specified time for print head maintenance		Allows you to set a time for running the cleaning. Specify the time in the [Time (HH:MM)] entry box. For details, see " <a href="#">Periodic Auto Cleaning</a> " on page 30.

## Printer settings

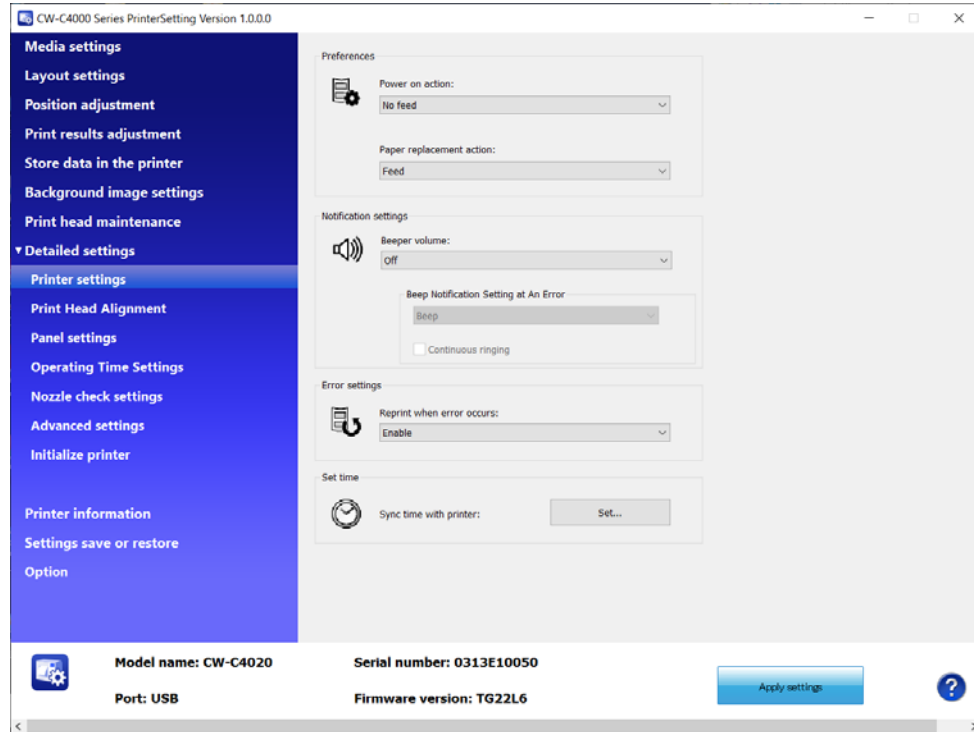
Allows you to configure the printer settings.



Item		Description
Preferences	Power on action	Select a printer action when the printer is powered on.
	Paper replacement action	Select a printer action when paper is replaced.
Notification settings	Beeper volume	Set the volume of the buzzer.
	Beep Notification Setting at An Error	Set whether to sound the buzzer when an error occurs. This setting is available when the [Beeper volume] setting is not [Off].
	Continuous ringing	Select the check box to let the buzzer sound continuously when an error occurs. To stop the beep, press the  (home) button or the  (back) button on the operation panel.
Error settings		Set whether or not to reprint when an error occurs.
Set time		Set the date and time settings of the printer.

## Print Head Alignment

Allows you to adjust the print head.

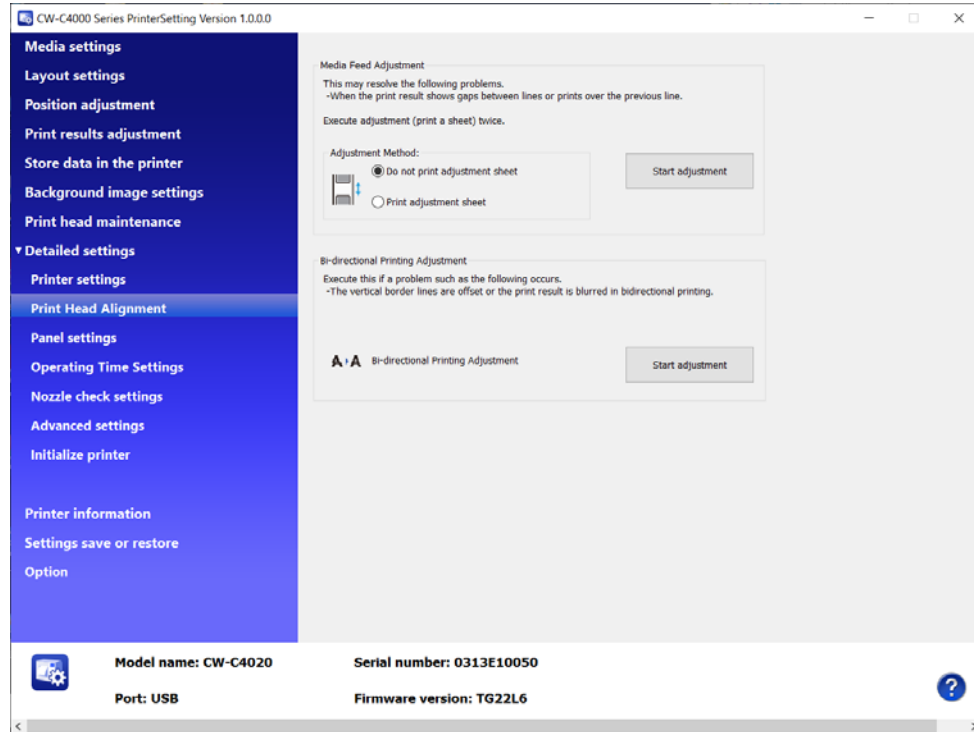

Item	Description
Media Feed Adjustment	Carry out this adjustment when white or black banding/streaks appear on printouts. Adjustment procedure <a href="#">"Media Feed Adjustment" on page 209</a>
Bi-directional Printing Adjustment	Carry out this adjustment when printed lines are skewed or misaligned, or printed text looks blurred. Adjustment procedure <a href="#">"Bi-directional Printing Adjustment" on page 211</a>



## Media Feed Adjustment

This allows you to adjust paper feeding when white or black banding/streaks appear on printouts.



### IMPORTANT

When printing the media feed adjustment pattern, load paper that is 21.4 mm (0.84 inches) wide or more and 34.0 mm (1.34 inches) long or more.

## Amount of Remaining Paper Required to Print a Media Feed Adjustment Pattern

### Continuous paper / continuous label

If the paper width is 21.4 mm (0.84 inches) or more: 311.5 mm (12.26 inches)



Printing a media feed adjustment pattern with black mark detection still enabled may increase the amount of remaining paper required. We recommend using settings where black marks are not detected, even for paper with black marks, when printing.

### Die-cut label (included roll paper)

For the included roll paper, the media feed adjustment pattern can be printed with three labels.

Included roll paper: paper width 108.0 mm (4.25 inches), paper length 174.8 mm (6.88 inches), gap between pages 3.0 mm (0.12 inches)



We recommend using continuous paper, continuous labels, or the included roll paper. The recommended length for printing the media feed adjustment pattern on die-cut labels is 34.0 mm (1.34 inches) or more.

Adjustment method	Description
Do not print adjustment sheet	Select this method if you do not have die-cut label, continuous paper, or full-page label paper with a length of 66.7 mm or longer. Prepare print data that you can easily check banding or streaks on printouts, and then configure the settings by printing and adjusting repeatedly.
Print adjustment sheet	Select this method to print a preset patterns for adjustment on die-cut label, continuous paper, or full-page label paper with a length of 66.7 mm or longer, and carry out the adjustment using the printed patterns.



When printing for the Media Feed Adjustment, keep the printer settings unchanged from the settings you usually use.

### Do not print adjustment sheet

- 1 Prepare print data that you can easily check banding or streaks on printouts.
- 2 Print the prepared data from the printer.

- 3** Select [Do not print adjustment sheet] from [Adjustment Method], and then click [Start adjustment].
- 4** The first Media Feed Adjustment window appears. Look at the print results and then select a setting value.

After selecting a setting value, click [OK].

If there are gaps (white banding), make the adjustment in the + direction.

If there is overlapping in the print results (black banding), make the adjustment in the – direction.

The adjustment increment is 0.0105 mm (1/2400 inch).

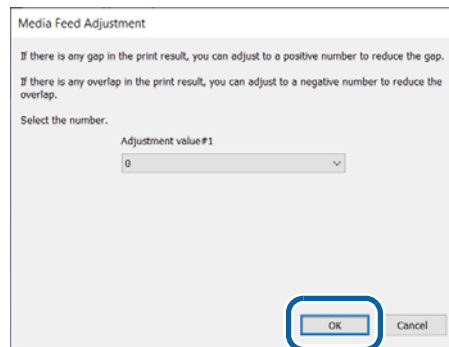

- 5** An adjustment start confirmation window appears. Click [Yes].  
The second Media Feed Adjustment window appears.
- 6** In the same way as step 4, look at the print results and then select a setting value.
- 7** When adjustment is complete, a complete window appears. Click [OK].
- 8** Print the data prepared in step 1 again.
- 9** Check the print results.  
If gaps are no longer conspicuous, the setting is complete.  
To make further adjustment, repeat steps 3 to 9.

### Print adjustment sheet

- 1** Load die-cut label, continuous paper, or full-page label paper with a length of 66.7 mm or more into the printer.
- 2** Select [Print adjustment sheet] from [Adjustment Method], and then click [Start adjustment].
- 3** A confirmation window to print the adjustment sheet appears. Check that paper is loaded in the printer and then click [OK].  
The adjustment sheet is printed and the first Media Feed Adjustment window appears.

- 4** Check the sheet and then select the number for the pattern with the least gaps or overlapping in #1 group, and then click [OK].

Adjustment sheet print example (for this sheet, select "0")

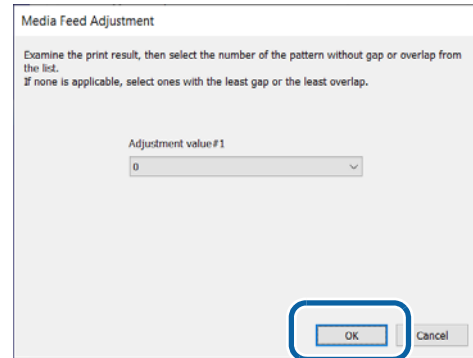
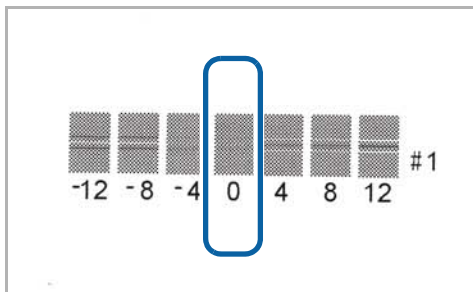

- 5** A confirmation window to print the adjustment sheet appears again. Click [Yes].  
The adjustment sheet is printed and the second Media Feed Adjustment window appears.
- 6** In the same way as step 4, look at the print results and then select a setting value.
- 7** An adjustment start confirmation window appears. Click [Yes].
- 8** When adjustment is complete, a complete window appears. Click [OK].

## Bi-directional Printing Adjustment

When printed vertical or horizontal lines look skewed or misaligned, or when printed text looks blurred, perform the Bi-directional Printing Adjustment.



### IMPORTANT

When printing the bi-directional printing adjustment pattern, load paper that is 99.5 mm (3.92 inches) wide or more and 69.0 mm (2.72 inches) long or more.

## Amount of Remaining Paper Required to Print a Bi-directional Printing Adjustment Pattern

### Continuous paper / continuous label

If the paper width is 99.5 mm (3.92 inches) or more: 365.3 mm (14.38 inches)



Printing a bi-directional printing adjustment pattern with black mark detection still enabled may increase the amount of remaining paper required. We recommend using settings where black marks are not detected, even for paper with black marks, when printing.

### Die-cut label (included roll paper)

For the included roll paper, the bi-directional printing adjustment pattern can be printed with four labels.

Included roll paper: paper width 108.0 mm (4.25 inches), paper length 174.8 mm (6.88 inches), gap between pages 3.0 mm (0.12 inches)



- When printing the bi-directional printing adjustment pattern with die-cut labels, the amount of remaining paper required depends on the paper width, paper length, and gap between pages. Since some combinations require paper lengths of up to 1,356 mm (53.4 inches), we recommend using continuous paper, continuous labels, or the included roll paper.
- Whether or not to perform bi-directional printing can be set in [Print Quality] - [Advanced] - [Bidirectional Printing] on the printer driver.

- 1 Load die-cut label, continuous paper, or full-page label paper with a length of 66.7 mm or more into the printer.**
- 2 Click [Start adjustment].**  
A confirmation window to print the sheet for Bi-directional Printing Adjustment appears.
- 3 Check that paper is loaded in the printer and then click [OK].**  
The adjustment sheet is printed and the bi-directional printing adjustment window appears.

**4** Check the sheet and then select the number for the pattern with the least gaps or overlapping in each of #1, #2, and #3 groups, and then click [OK].

Adjustment sheet print example (for this sheet, select "2" for #1 group, select "0" for #2 group, and select "2" for #3 group.)

The image displays three groups of patterns, labeled #1, #2, and #3, each with a vertical axis ranging from -6 to 6. In group #1, the pattern with value 2 is circled. In group #2, the pattern with value 0 is circled. In group #3, the pattern with value 2 is circled. To the right, a dialog box titled "Bi-directional Printing Adjustment" is shown. It contains three dropdown menus: "Adjustment value#1" set to 0, "Adjustment value#2" set to 2, and "Adjustment value#3" set to 0. The dialog box also has "OK" and "Cancel" buttons.

**5** An adjustment start confirmation window appears. Click [Yes].

**6** When adjustment is complete, a complete window appears. Click [OK].

## Panel settings

Allows you to configure the panel settings.

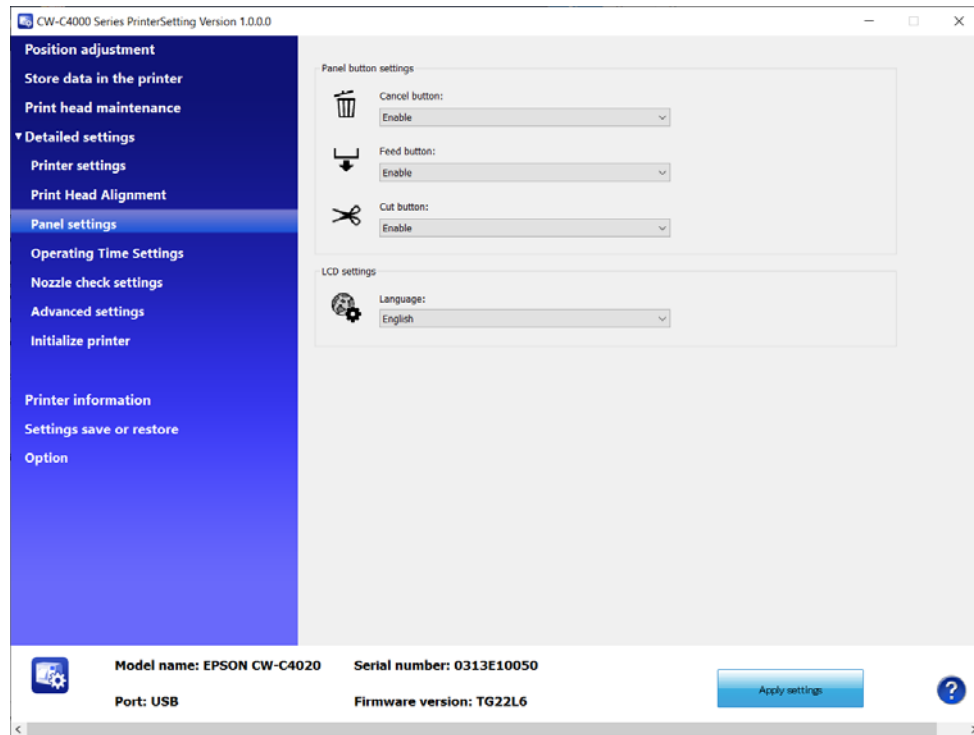

Item		Description
Panel button settings	Cancel button	Select whether to enable or disable the cancel button.
	Feed button	Select whether to enable or disable the feed button.
	Cut button	Select whether to enable or disable the cut button.
LCD settings		Select the language to display.

## Operating Time Settings

Allows you to change the power saving settings.

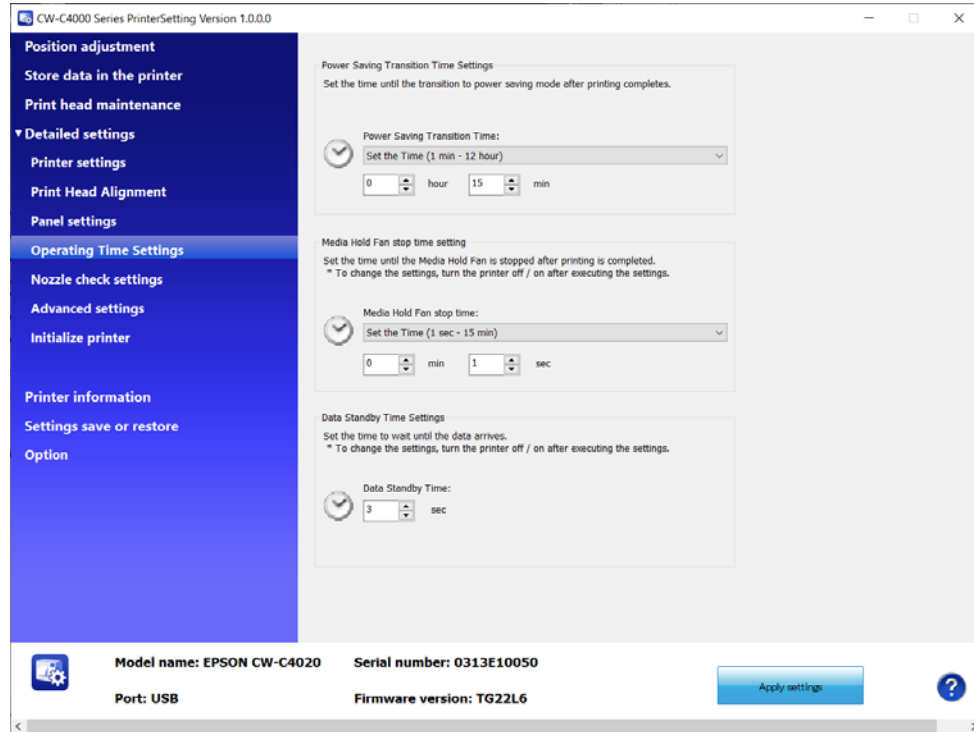

Item	Description
Power Saving Transition Time Settings	Set the time until the printer enters the power saving mode after completing printer operations such as printing and regular automatic cleaning.
Media Hold Fan stop time setting	Set the time until the paper suction fan is stopped after printing is completed.
Data Standby Time Settings	Set the time to wait for data to arrive. Increasing the data waiting time may result in a slight increase in ink consumption. Normally, it is recommended to use a setting below the default value.

## Nozzle check settings

Allows you to change the nozzle check settings.

For more details about the nozzle check, see ["Auto Nozzle Check System"](#) on page 26, and for more details about the dot substitution function, see ["Complementing Missing Dots due to Clogged Nozzles \(Nozzle Verification Technology\)"](#) on page 29.

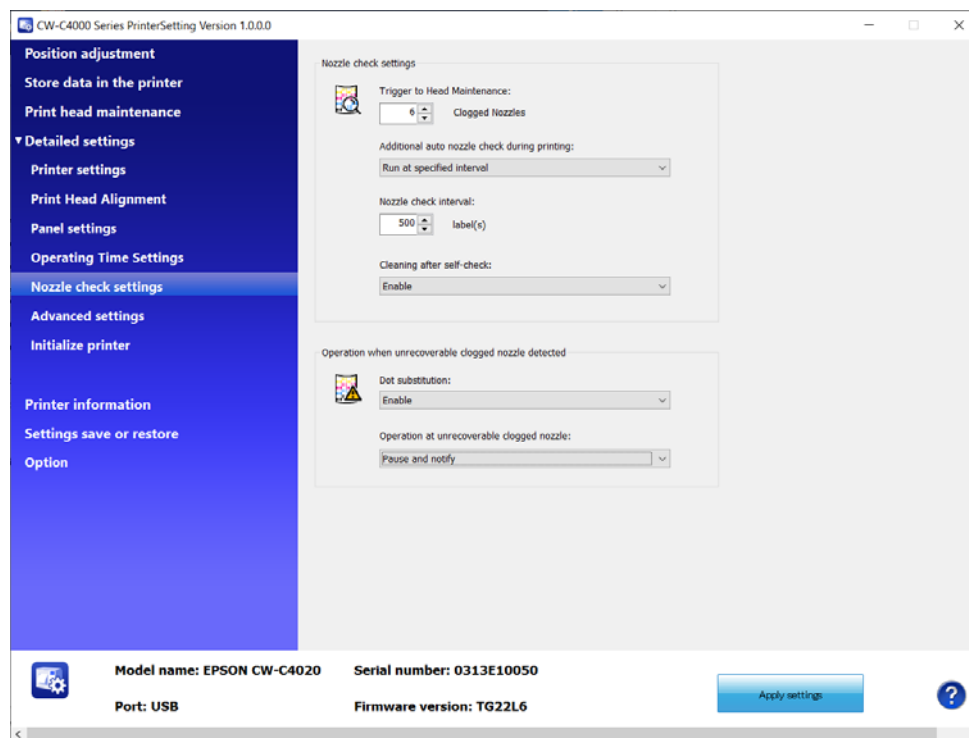

Item		Description
Nozzle check settings	Trigger to Head Maintenance	Specify the allowable number of clogged nozzles to be used for the self nozzle check system.
	Additional auto nozzle check during printing	Set whether or not to run the self-nozzle check system during printing.
	Nozzle check interval	Specify the interval of nozzle check when [Additional auto nozzle check during printing] is set to be performed at the specified interval.
	Cleaning after self-check	Select whether to run an auto cleaning after self-check.
Operation when unrecoverable clogged nozzle detected	Dot substitution	Select whether to enable or disable the Dot substitution function. See <a href="#">"Complementing Missing Dots due to Clogged Nozzles (Nozzle Verification Technology)"</a> on page 29.
	Operation at unrecoverable clogged nozzle	Set the action to be taken when the number of clogged nozzles exceeds the number set at [Trigger to Head Maintenance].



## Advanced settings

Allows you to configure the advanced printer settings.

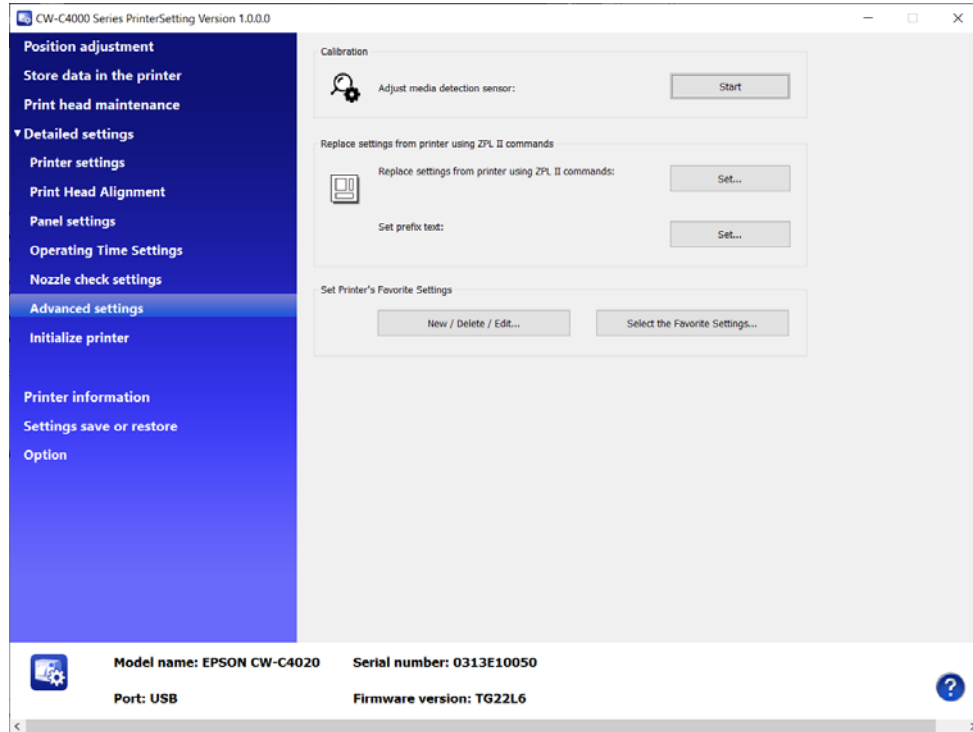

Item		Description
Calibration		Allows you to carry out calibration of sensors.
Replace settings from printer using ZPL II commands	Replace settings from printer using ZPL II commands	Allows you to make and apply settings for replacing from a ZPL II compatible monochrome printer. The "Replace settings from printer using ZPL II commands" window appears when you click [Set...]. See " <a href="#">Settings for Replacing from ZPL II Compatible Monochrome Printer</a> " on page 218.
	Set prefix text	Allows you to set prefix text.
Set Printer's Favorite Settings		Allows you to register favorite settings to the printer, or edit the settings. See " <a href="#">Registering Favorite Settings</a> " on page 222.

## Settings for Replacing from ZPL II Compatible Monochrome Printer

Click [Set...] for [Replace settings from printer using ZPL II commands] to open the setting window.



When adjusting, make the adjustment checking actual printouts.

### Resolution Settings

Select the resolution in the [Original Resolution] pull-down menus.

If the same resolution is not found in the menus, select one of the closest resolution. For example, if the resolution of the ZPL II compatible monochrome printer you were using is 203 dpi, select 200 dpi.

### Monochrome Print Mode Setting

If you use the printer just as a replacement of your previous ZPL II compatible monochrome printer and do not perform color printing, select the check box.

### Vertical/Horizontal Positioning

You can adjust the print position of objects such as text, image, or graphic.

If you have set the same resolution as the resolution of the ZPL II compatible monochrome printer in the [Original Resolution] setting, set “0” (zero) to both the [Vertical positioning] and [Horizontal positioning].

If the resolution of the ZPL II compatible monochrome printer you were using is 203 dpi, and you have set the [Original Resolution] setting to [200 dpi], set “-1.5” to both the [Vertical positioning] and [Horizontal positioning].

## Font Replacement

Click [Settings] beside [Font replacement].

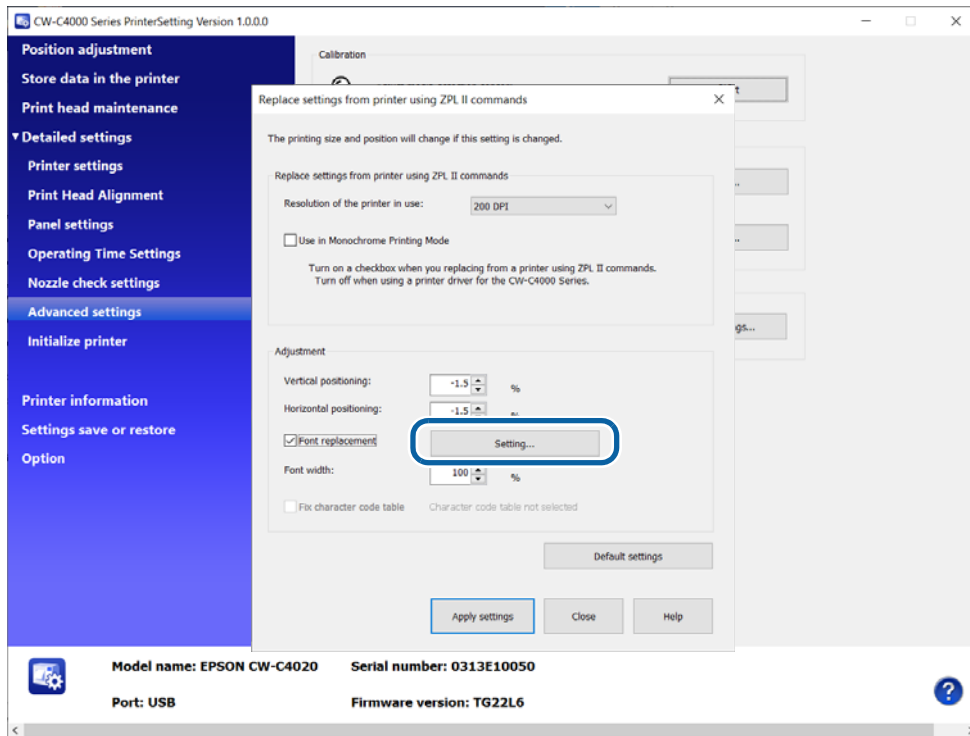

When the setting window is displayed, select the font ID from the list box.

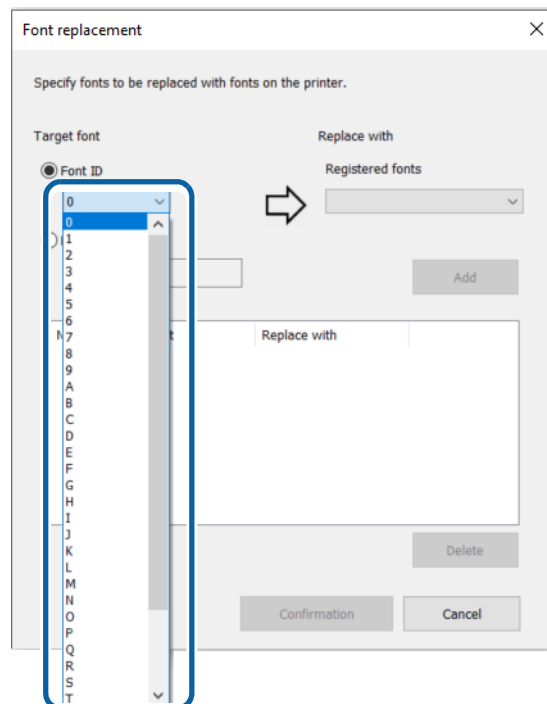

With the font ID specified, select a registered font to be associated to the font ID.

Font replacement

Specify fonts to be replaced with fonts on the printer.

Target font

Font ID

0

Font name

Replace with

Registered fonts

FONT000.TTF

FONT000.TTF

FONT001.TTF

Add

No.	Target font	Replace with

Delete

Confirmation Cancel

Click [Add] to add the pair to the list in the window.

Click [Confirmation] to save the list and go back to the “Replace settings from printer using ZPL II commands” window.

Select the check box for [Font replacement] to apply the font replacement settings.

Font replacement

Specify fonts to be replaced with fonts on the printer.

Target font

Font ID

0

Font name

Replace with

Registered fonts

FONT000.TTF

Add

No.	Target font	Replace with
1	0	FONT000.TTF

Delete

Confirmation Cancel

### Font Width Setting

You can change the font width. At first, set to “100”.



If you want to change the height of font or space between lines, configure it on an application.

### Fix Character Code Table

Select the check box for this item to print using character code table set on the CW-C4000 Series printer if an unsupported character code is specified.

### Applying the Settings

When you have finished making necessary settings, click [Apply settings].

All the settings are sent and set to the printer.

## Registering Favorite Settings

- 1 Click [New/Delete/Edit] in [Set Printer's Favorite Settings].
- 2 The "Edit Printer's Favorite Settings" window appears. Click [New...].

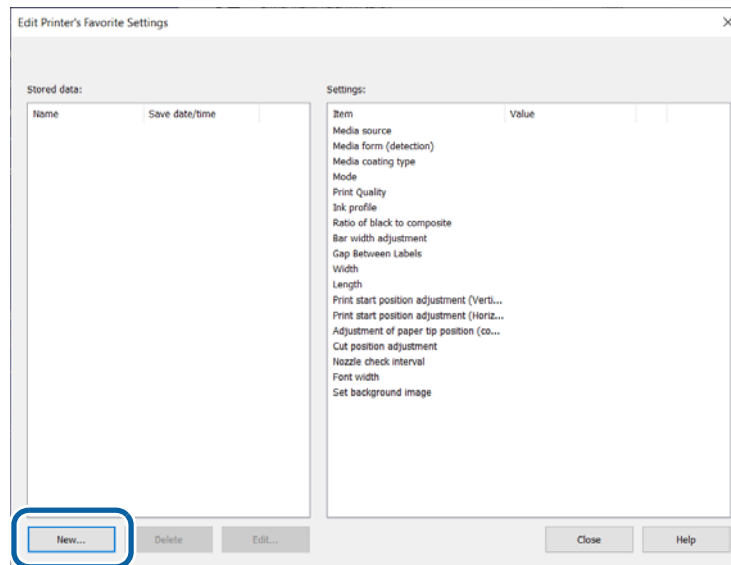

- 3** The “Register Printer’s Favorite Settings” window appears. Enter a name for the settings in the [Favorite Settings Name] box, and make the settings in [Printer’s Favorite Settings]. When finished, click [Set].



- For the favorite settings name, you can use up to 15 ASCII (20h to 7Eh) characters excluding ^, ~, ;, comma, and period.
- Up to 100 sets of favorite settings can be registered.

When you want to reset your settings to the default settings, click [Default settings].

The screenshot shows the 'Register Printer's Favorite Settings' dialog box. At the top, there is a text input field for 'Favorite Settings Name'. Below it is the 'Printer's Favorite Settings' section, which contains various configuration options:

- Media source:** Internal (Roll)
- Units:** mm
- Nozzle check interval:** 100
- Media form (detection):** Die-cut label (black mark detection)
- Width:** 108.0
- Media coating type:** Matte Paper
- Length:** 174.8
- Font width (%):** 100
- Mode:** EPSON Vivid Color
- Gap Between Labels:** 3.0
- Print Quality:** Normal
- Print start position adjustment (Vertical):** 0.0
- Ink profile:** 0
- Print start position adjustment (Horizontal):** 0.0
- Set background image:** Do not use background image
- Ratio of black to composite:** 0
- Adjustment of paper tip position:** 0.0
- Background image:** (empty field)
- Bar width adjustment:** 0
- Cut position adjustment:** 0.0

At the bottom of the dialog, there are four buttons: 'Default settings', 'Set', 'Close', and 'Help'. The 'Set' button is highlighted with a blue box.

- 4** Click [Close] to return to the “Edit Printer’s Favorite Settings” window. The favorite settings you added are displayed in the [Stored data] box.

## Applying Favorite Settings

Follow the procedure below to apply the registered favorite settings to the printer.

- 1 Click [Select the Favorite Settings] in [Set Printer's Favorite Settings].
- 2 The "Select Printer's Favorite Settings" window appears. In the [Favorite Settings Name] box, select a set of favorite settings you want to apply to the printer, and then click [Apply settings].

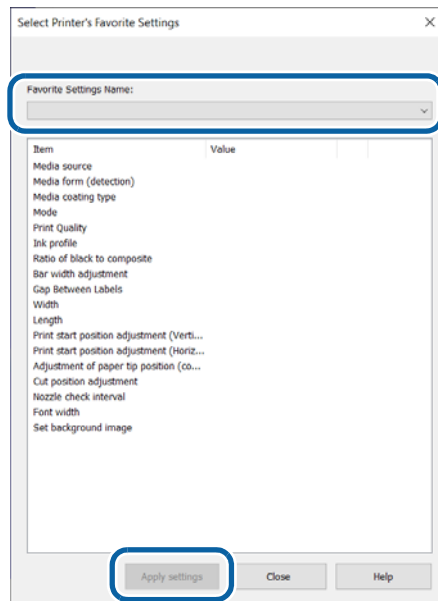

If changing between different media, you may find it easier save different Favorite Setting with different sets of Print Start Position Adjustment values.



## Initialize printer

Allows you to initialize the printer.



When the printer is initialized using the [Initialize] menu, all image files and setting files you have registered are deleted.

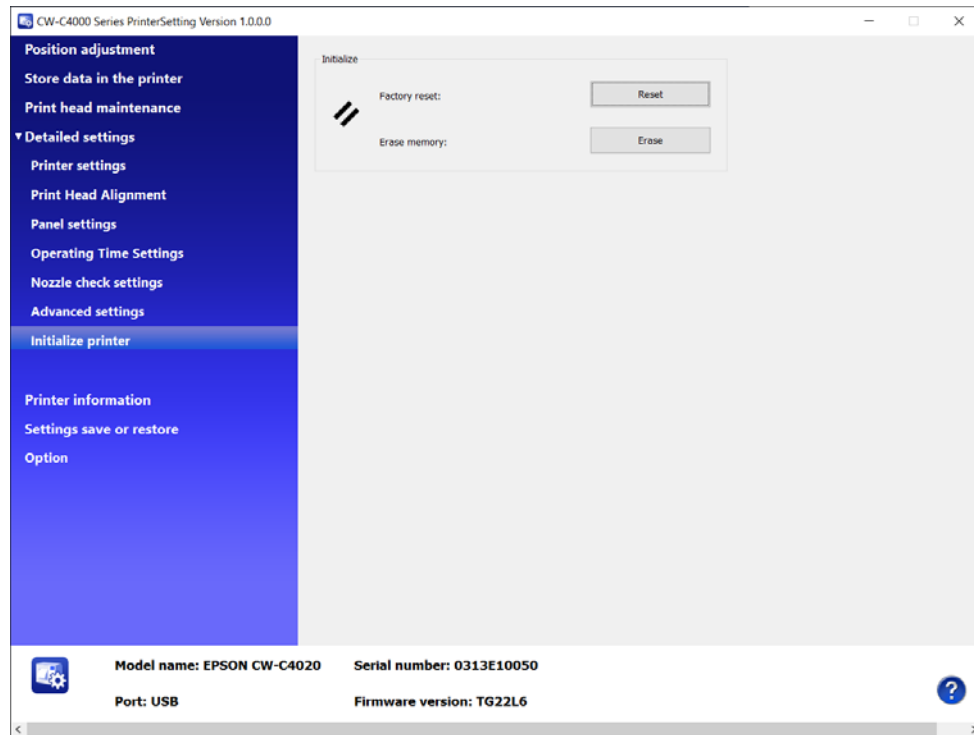

Item		Description
Initialize	Factory reset	Returns the printer settings to their defaults.
	Erase memory	Initializes the extended memory.

## Printer information

Displays information of the printer.

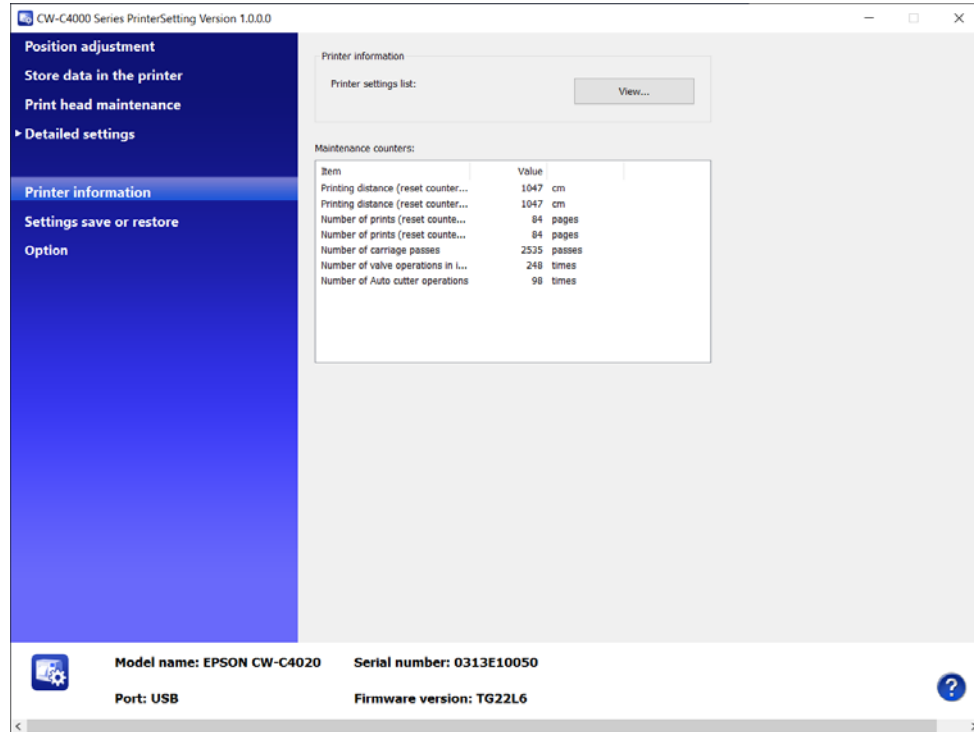

Item		Description
Printer information	Printer settings list	Click [View...] to see the current settings of the printer. See " <a href="#">Printer settings list</a> " on page 227.
Maintenance counters		Allows you to check the maintenance counters.

## Printer settings list

The “Printer settings list” window appears when you click [View...]. You can save the settings as a file by clicking [Output to file...].

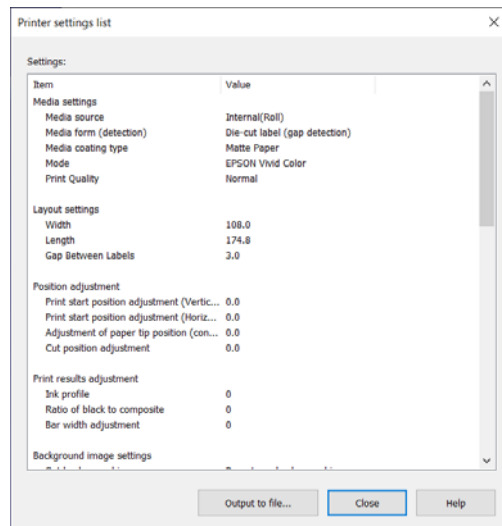

## Settings save and restore

Allows you to save the settings of the printer and restore the saved settings.

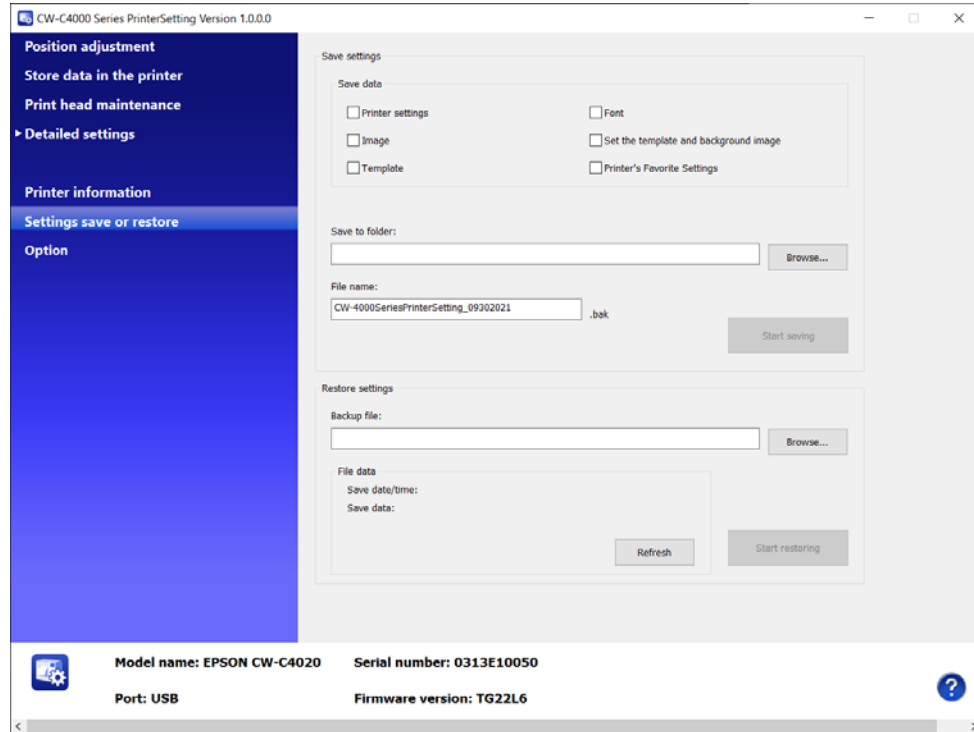

Item		Description
Save settings	Save data	Select setting items to save. Select the check box for the items.
	Save to folder	Specify a folder to save the file.
	File name	Enter a file name.
	Start saving	Click [Start saving] after selecting items to save, specifying a file name and a folder to save. The selected settings will be saved.
Restore settings	Backup file	Select a setting file you have saved.
	File data	Information of the selected file is displayed.
	Start restoring	Click [Start restoring] after selecting a file to restore. The settings of the selected file will be applied.



It may take time depending on the size of the file.

## Option

A unit of length used in PrinterSetting and start up setting can be changed.

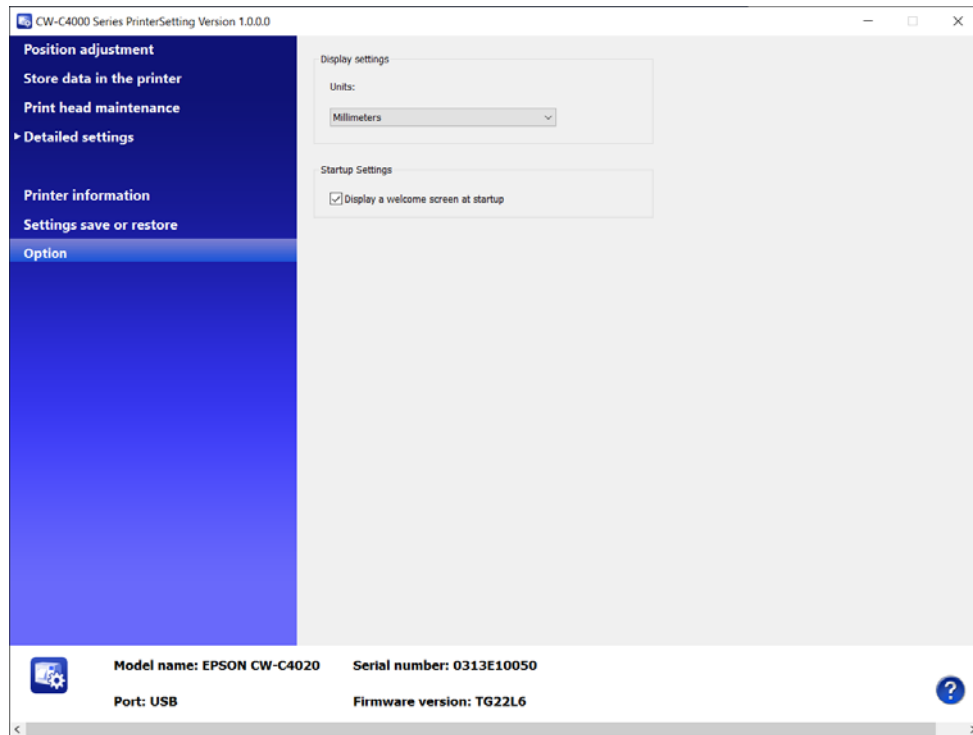

Item		Description
Display settings	Units	Select a unit of length.
Startup Settings	Display a welcome screen at startup	Select whether to display welcome screen at startup.



The [Units] setting is for PrinterSetting itself. It cannot be applied to the printer and the printer driver.

## Operation Panel Settings

The following tables show the menu items and options available on the operation panel with their default settings and whether they can be locked with Lock Setting of the System Administration settings. For more details about the Lock Setting, see ["Restricting Operation of the Operation Panel \(Lock Setting function\)"](#) on page 283.

Setting menu	Settings	Default	Lock Setting		
			General Settings	Printer Settings	Media Settings
Media Settings					
Media Type					
	Plain Paper	Matte Paper	-	-	✓
	Matte Paper		-	-	✓
	Synthetic		-	-	✓
	Texture Paper		-	-	✓
	Wristband		-	-	✓
	Glossy Paper		-	-	✓
	Glossy Film		-	-	✓
	High Glossy Paper		-	-	✓
Media Form					
	Die-cut Label	Die-cut Label	-	-	✓
	Full-page Label		-	-	✓
	Continuous Paper		-	-	✓
	Wristband		-	-	✓
Media Detect					
	Gap	Gap	-	-	✓
	Black Mark		-	-	✓
	None		-	-	✓
Media Source					
	Internal	Internal	-	-	✓
	Rear Feed		-	-	✓
Media Shape					
	Roll	Roll	-	-	✓
	Fanfold		-	-	✓

Setting menu	Settings	Default	Lock Setting		
			General Settings	Printer Settings	Media Settings
Media Layout					
Width					
Die-cut Label/ Full-page Label	21.4-108.0[mm]/ 0.84-4.25[inch]	108 mm/ 4.25 inch	-	-	✓
Continuous Paper/ Wristband	25.4-108.0[mm]/ 1.00-4.25[inch]	108 mm/ 4.25 inch	-	-	✓
Length					
	8.0-406.4[mm]/ 0.31-16.00[inch]	174.8 mm/ 6.88 inch	-	-	✓
Gap between labels					
Die-cut Label	2.0-6.0[mm]/ 0.08-0.24[inch]	3[mm]/ 0.12[inch]	-	-	✓
Other than Die-cut Label	0.0-6.0[mm]/ 0.0-0.24[inch]	0[mm]/0[inch]	-	-	✓
Print Position Adjustment					
Top Position * Adjust the print start position on the media	-10.9 to +10.9[mm] / -0.43 to +0.43[inch]	0[mm]/0[inch]	-	-	✓
Left Position * Adjust the print start position on the media	-1.5 to +1.5[mm] / -0.06 to +0.06[inch]	0[mm]/0[inch]	-	-	✓
Paper Top Position Adjustment	0.0 to 3.0[mm] / 0.0 to 0.12[inch]	0[mm]/0[inch]	-	-	✓
Media Size Notice					
	On	Off	-	-	✓
	Off		-	-	✓

Setting menu	Settings	Default	Lock Setting			
			General Settings	Printer Settings	Media Settings	
Print Settings						
Media Type						
	Plain Paper	Matte Paper	✓	-	-	
	Matte Paper		✓	-	-	
	Synthetic		✓	-	-	
	Texture Paper		✓	-	-	
	Wristband		✓	-	-	
	Glossy Paper		✓	-	-	
	Glossy Film		✓	-	-	
	High Glossy Paper		✓	-	-	
Color Adjustment Mode						
	EPSON Vivid Color	EPSON Vivid Color	✓	-	-	
	EPSON Preferred Color		✓	-	-	
	None		✓	-	-	
Print Quality						
	Max Speed	Depend on the media you use	✓	-	-	
	Speed		✓	-	-	
	Normal		✓	-	-	
	Quality		✓	-	-	
	Max Quality		✓	-	-	
Resolution						
	200 dpi	600 dpi	✓	-	-	
	300 dpi		✓	-	-	
	600 dpi		✓	-	-	
Command Character						
	Control Prefix	0X20 to 7E	0X7E	✓	-	-
	Format Command Prefix	0X20 to 7E	0X5E	✓	-	-
	Delimiter Characters	0X20 to 7E	0X2C	✓	-	-



Setting menu	Settings	Default	Lock Setting		
			General Settings	Printer Settings	Media Settings
Maintenance					
Print Head Nozzle Check	-	-	-	-	-
Print Head Cleaning	-	-	-	-	-
Power Cleaning	-	-	-	-	-
Ink Cartridge Replacement	-	-	-	-	-
Replace Maintenance Box	-	-	-	-	-
Print Head Alignment					
	Vertical Alignment	-	-	✓	-
	Horizontal Alignment	-	-	✓	-
Calibration					
	Simple Media Detect	-	-	✓	-
	Media Detect	-	-	✓	-
Nozzle check settings					
Nozzle check settings	On	On	-	✓	-
	Off		-	✓	-
Nozzle Check Interval	1 to 9999 [copies]	100 [copies]	-	✓	-
Operation At Clogged Nozzle	Notify	Continue Printing	-	✓	-
	Continue print		-	✓	-
Threshold Of Clogged Nozzles	0 to 16 [nozzles]	2 [nozzles]	-	✓	-
Cleaning After Nozzle Check	On	On	-	✓	-
	Off		-	✓	-
Clear All Settings	-	-	-	✓	-
Periodic Cleaning	00:00 to 23:59 (in increments of 1 min.)	00:00	-	✓	-
Ink Discharging	-	-	-	✓	-

Setting menu	Settings	Default	Lock Setting		
			General Settings	Printer Settings	Media Settings
General Settings					
Basic Settings					
LCD Brightness	1 to 5	5	✓	-	-
Sound					
	Off	Max	✓	-	-
	Low		✓	-	-
	Medium		✓	-	-
	High		✓	-	-
	Max		✓	-	-
Error Notice					
Error Notice	On	On	✓	-	-
	Off		✓	-	-
Repeat Error Notice	On	Off	✓	-	-
	Off		✓	-	-
Length Unit					
	mm	mm	✓	-	-
	inch		✓	-	-
Max Data Wait Time					
	1 to 15 seconds	3.0 seconds	✓	-	-
Platen Vacuum Fun					
Stop at Sleep	-	Use Stop Timer	✓	-	-
Use Stop Timer	1 to 900 seconds		✓	-	-
Sleep					
Settings	On	On	✓	-	-
	Off		✓	-	-
Sleep Timer	1 to 720 minutes	15 minutes	✓	-	-
Circuit Breaker Interlock Startup					
	On	Off	✓	-	-
	Off		✓	-	-

Setting menu	Settings	Default	Lock Setting		
			General Settings	Printer Settings	Media Settings
Date/Time Settings					
Date/Time	-	-	✓	-	-
Daylight Saving Time	Winter	Winter	✓	-	-
	Summer		✓	-	-
Time Difference	+13:45 to -12:45 (in increments of 15 min.)	-	✓	-	-
Language					
	Nederlands	English	-	-	-
	English		-	-	-
	Français		-	-	-
	Deutsch		-	-	-
	Ελληνικά		-	-	-
	Italiano		-	-	-
	日本語		-	-	-
	한국어		-	-	-
	Polski		-	-	-
	Português		-	-	-
	Русский		-	-	-
	简体中文		-	-	-
	Español		-	-	-
	繁體中文		-	-	-
	Türkçe	-	-	-	
Background Color					
	Gray	White	-	-	-
	Black		-	-	-
	White		-	-	-
Keyboard					
	QWERTY	QWERTY	-	-	-
	AZERTY		-	-	-
	QWERTZ		-	-	-

Setting menu	Settings	Default	Lock Setting		
			General Settings	Printer Settings	Media Settings
Control Panel Button Settings					
Cut	Enable	Enable	✓	-	-
	Disable		✓	-	-
Cancel	Enable	Enable	✓	-	-
	Disable		✓	-	-
Feed	Enable	Enable	✓	-	-
	Disable		✓	-	-
Printer Settings					
Image Quality					
Manual Color Adjustments					
Light	-25 to +25	0	-	✓	-
Saturation	-25 to +25	0	-	✓	-
Contrast	-25 to +25	0	-	✓	-
Tone -Cyan	-25 to +25	0	-	✓	-
Tone - Magenta	-25 to +25	0	-	✓	-
Tone -Yellow	-25 to +25	0	-	✓	-
Ink Profile	-6 to +4 (in increments of 1)	0	-	✓	-
Ratio of Black to Composite	-6 to 0 (in increments of 1)	0 * Changes to "-2" with matte black, Plain Paper, Matte Paper or Texture Paper, Print Quality is Speed, Normal, or Quality	-	✓	-
Dry Time	0 to 5 sec. (in increments of 0.1 sec.)	0 sec.	-	✓	-
Nozzle Verification Technology					
	Enable	Enable	-	✓	-
	Disable		-	✓	-
Bar Width Adjustment	- 2 to +2 (in increments of 1)	0	-	✓	-

Setting menu	Settings	Default	Lock Setting		
			General Settings	Printer Settings	Media Settings
Print Options					
Print Mode					
	Cut	Stop at Cut Position	-	✓	-
	Stop at Cut Position		-	✓	-
	Stop at Peel-Off Position		-	✓	-
	Stop at Print End Position		-	✓	-
Cut Position	-10.8 to +10.8[mm] / -0.425 to +0.425[inch]	0[mm]/ 0[inch]	-	✓	-
Reprint					
	Enable	Enable	-	✓	-
	Disable		-	✓	-
Media Hold Pressure					
	Auto	Auto	-	✓	-
	Manual (1 to 10)		-	✓	-
Cancel Action					
	Job ONLY	Job ONLY	-	✓	-
	Job/RAM Drive		-	✓	-
Actions when Replacing Media					
	Feed	Feed	-	✓	-
	Not Feed		-	✓	-
	Calibration		-	✓	-
	Short Calibration		-	✓	-
	Check Media Size		-	✓	-
Actions on Power On					
	Feed	Not Feed	-	✓	-
	Not Feed		-	✓	-
	Calibration		-	✓	-
	Short Calibration		-	✓	-
	Check Media Size		-	✓	-

Setting menu	Settings	Default	Lock Setting		
			General Settings	Printer Settings	Media Settings
Network Settings					
Wi-Fi Setup					
Router					
Wi-Fi Setup Wizard	-	-	✓	-	-
Push Button Setup (WPS)	-	-	✓	-	-
Others	PIN Code Setup (WPS)	PIN Code Setup (WPS)	✓	-	-
	Wi-Fi Auto Connect		✓	-	-
	Disable Wi-Fi		✓	-	-
Wi-Fi Direct					
iOS	-	-	✓	-	-
Other OS Devices	-	-	✓	-	-
Menu					
Change Network Name		-	✓	-	-
Change Password		-	✓	-	-
Change Frequency Range	2.4 GHz	2.4 GHz	✓	-	-
	5 GHz		✓	-	-
Disable Wi-Fi Direct		-	✓	-	-
Restore Default Settings		-	✓	-	-
Wired LAN Setup					
Network Status					
Wired LAN/Wi-Fi Status		-	✓	-	-
Wired LAN Status		-	✓	-	-
Wi-Fi Direct Status		-	✓	-	-
Print Status Sheet		-	✓	-	-
Connection Check					

Setting menu	Settings	Default	Lock Setting		
			General Settings	Printer Settings	Media Settings
Advanced					
Device Name	-	-	✓	-	-
TCP/IP	-	-	✓	-	-
Proxy Server	-	-	✓	-	-
IPv6 Address					
	Enable	Enable	✓	-	-
	Disable		✓	-	-
Link Speed & Duplex					
	Auto	Auto	✓	-	-
	10BASE-T Half Duplex		✓	-	-
	10BASE-T Full Duplex		✓	-	-
	100BASE-TX Half Duplex		✓	-	-
	100BASE-TX Full Duplex		✓	-	-
Redirect HTTP to HTTPS					
	Enable	Enable	✓	-	-
	Disable		✓	-	-
Disable IPsec/IP Filtering	-	-	✓	-	-
Disable IEEE802.1X	-	-	✓	-	-

Setting menu	Settings	Default	Lock Setting		
			General Settings	Printer Settings	Media Settings
System Administration					
Clear Internal Memory Data	-	-	✓	-	-
Security Settings					
Admin Settings					
Admin Password					
	Change	-	✓	-	-
	Restore Default Settings	-	✓	-	-
Lock Setting					
	On	Off	✓	-	-
	Off		✓	-	-
General Settings					
	On	-	✓	-	-
	Off	*Fixed to "On" when Lock Setting is set to On.	✓	-	-
Printer Settings					
	On	Off	✓	-	-
	Off		✓	-	-
Paper Setting					
	On	Off	✓	-	-
	Off		✓	-	-
Password Encryption					
	On	Off	✓	-	-
	Off		✓	-	-
Restore Default Settings					
Network Settings	-	-	✓	-	-
Media Detect	-	-	✓	-	-
All Settings	-	-	✓	-	-
Language	-	-	-	-	-
Favorite Setting	-	-	-	-	-
Supply Status	-	-	-	-	-



Setting menu	Settings	Default	Lock Setting		
			General Settings	Printer Settings	Media Settings
Printer Status/Print					
Firmware Version	Printer	-	-	-	-
Print Status Sheet					
Configuration Status Sheet	-	-	-	-	-
Font List	-	-	-	-	-
Supply Status Sheet	-	-	-	-	-
Usage History Sheet	-	-	-	-	-
PS3 Status Sheet	-	-	-	-	-
Network	-	-	-	-	-
Maintenance Counters					
Total Length	-	-	-	-	-
Length 1	-	-	-	-	-
Length 2	-	-	-	-	-
Total Pages	-	-	-	-	-
Pages 1	-	-	-	-	-
Pages 2	-	-	-	-	-
Total CR	-	-	-	-	-
Ink Path Valve	-	-	-	-	-
Auto Cut Counter					
Total Auto Cut	-	-	-	-	-
After Replacement (Reset Counter)	-	-	-	-	-
Unit Replacement	-	-	-	-	-
Previous Replacement Date	-	-	-	-	-

# WebConfig

WebConfig is an application software that allows you to check or change the printer settings using a web browser on a computer.

To use WebConfig, you need to set up an IP address to the printer in advance.

Connect the computer to the same network as the printer.



It is not possible to set the administrator logon to be unnecessary. If you forget the administrator password, you can initialize it. ("[Resetting the Administrator Password](#)" on page 285)

## How to Start WebConfig

Start a web browser on a computer or device that is connected via a network, and then type the printer IP address into the browser.

To change the printer settings, log in from [Administrator Login] on the upper right corner of the screen.

Leave the User Name field blank. The following shows initial value for the password.

If there is a password label applied to the rear of the printer, the value for "PASSWORD" is the initial value.

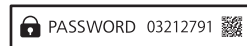

In the example shown, the initial password is 03212791.

If there is no password label, the initial value is the serial number of the printer.

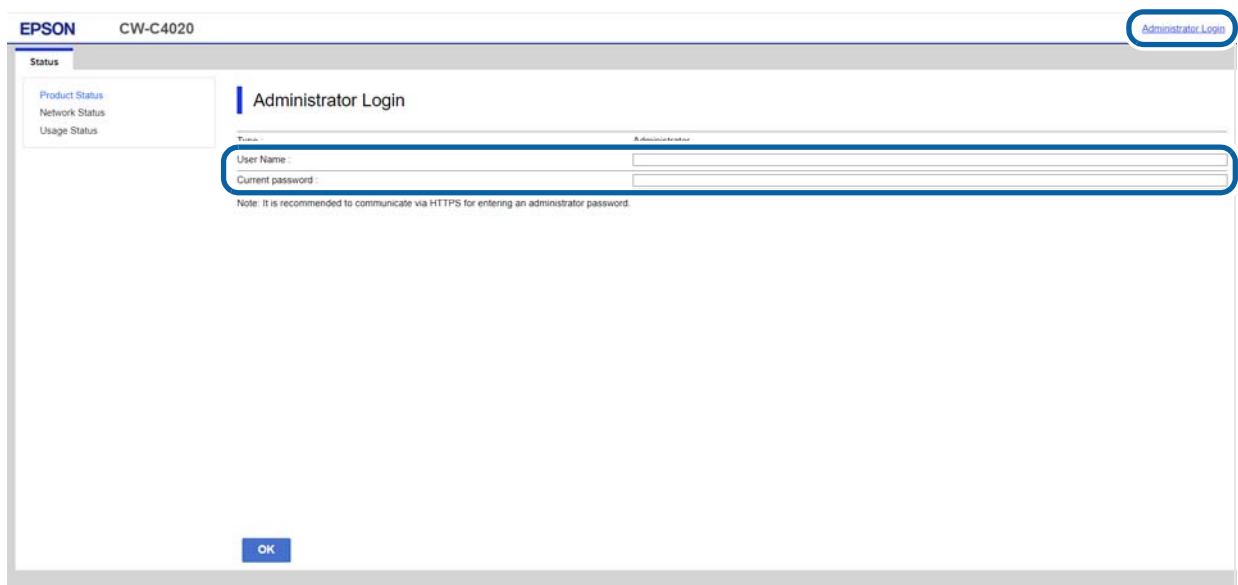

Enable the JavaScript on the browser. Because the communication with the printer uses a self-signed certificate of the printer over HTTPS, a warning message is displayed on the browser when you start WebConfig.

### Communication over HTTPS

IPv4: `https://IP address of the printer`

IPv6: `https://[IP address of the printer]`

### Communication over HTTP

IPv4: `http://IP address of the printer`

IPv6: `http://[IP address of the printer]`

### Examples

IPv4:

`https://192.0.2.111/`

`http://192.0.2.111/`

IPv6:

`https://[2001:db8::1000:1]/`

`http://[2001:db8::1000:1]/`

## Epson Device Admin

Epson Device Admin is multifunctional software that allows you to manage printers on a network.

It offers the following functions.

- Monitoring and managing networked printers
- Issuing a detailed report on consumables and printer status
- Updating printer's firmware
- Installing a new networked printer
- Configuring various settings of a networked printer
- Configuring various settings of multiple networked printers at a time

You can download Epson Device Admin from the Epson website.

**IMPORTANT**

For the CW-C4000 Series printers, Epson Device Admin supports Ethernet connection only. It cannot be used if the printer is connected via USB.

# Loftware NiceLabel Cloud

NiceLabel Cloud is a cloud-based label management system. The entire process of creating labels, including design, management, data linkage, and printing, can be managed in the cloud. The printer must be registered in the cloud and set in the WebConfig or Epson Device Admin.

"Registering a Printer (WebConfig)" on page 245

"Registering a Printer (Epson Device Admin)" on page 251



For more information about how to use NiceLabel Cloud, select  in the upper right corner to view the Help section.

## Registering a Printer (WebConfig)

- 1 Open WebConfig, and log in from the [Administrator Login].  
WebConfig

The screenshot displays the EPSON CW-C4020 WebConfig interface. At the top, the EPSON logo and model number 'CW-C4020' are visible on the left, and an 'Administrator Login' button is on the right. The main content area is titled 'Product Status' and includes a sidebar with links for 'Product Status', 'Network Status', and 'Usage Status'. The 'Product Status' section contains a language dropdown menu set to 'English', a 'Printer Status' box indicating 'Available', and five ink level indicators for Black (MK), Yellow (Y), Magenta (M), Cyan (C), and Maintenance Box. Below these are several data fields:

Black (MK) :	SAC4P-MK
Yellow (Y) :	SAC4P-Y
Magenta (M) :	SAC4P-M
Cyan (C) :	SAC4P-C
Maintenance Box :	SMB400
Firmware :	06.32.TG25N7
Root Certificate Version :	02.02
Serial Number :	XB36000071
Network MAC Address :	DC:CD:2F:A5:C1:BA
Date and Time :	2023-08-23 16:01 UTC+09:00
Administrator Name/Contact Information :	

At the bottom of the page, there is a 'Refresh' button and a link to 'Software Licenses'.



For details on WebConfig, "[WebConfig](#)" on page 242.

## 2 Check the following settings in the [Network] tab.

- IP Address
- Subnet Mask
- Default Gateway
- Primary DNS Server
- Secondary DNS Server
- Proxy Server
- Proxy Server Port Number

### WebConfig

EPSON CW-C 4020 Administrator Logout

Status Print **Network** Network Security Product Security Device Management Maintenance

Basic  
Wired LAN  
NiceLabel Cloud  
»Basic

### Basic

Device Name : EPSONA5C1BA  
Location :

Note: The values in Device Name and Location are applied to multiple network protocols.

Obtain IP Address :  Auto  Manual  
Set using BOOTP :  Enable  Disable  
Set using Automatic Private IP Addressing (APIPA) :  Enable  Disable

IP Address : 192.168.74  
Subnet Mask : 255.255.252.0  
Default Gateway : 192.168.1

Primary DNS Server : 192.168.0  
Secondary DNS Server : 192.168.0

DNS Host Name Setting :  Auto  Manual  
DNS Host Name : EPSONA5C1BA  
DNS Domain Name Setting :  Auto  Manual  
DNS Domain Name :  
Register the network interface address to DNS :  Enable  Disable

Proxy Server Setting :  Do Not Use  Use

Proxy Server : 192.168.254  
Proxy Server Port Number : 8080

Proxy Server User Name :  
Proxy Server Password : \*\*\*\*\*

IPv6 Setting :  Enable  Disable  
IPv6 Privacy Extension :  Enable  Disable  
IPv6 DHCP Server Setting :  Do Not Use  Use  
IPv6 Address :  
IPv6 Address Default Gateway :  
IPv6 Link-Local Address : fe80::dec0:2fff:fea5:c1ba/64  
IPv6 Stateful Address :  
IPv6 Stateless Address 1 :

Next

## 3 Open NiceLabel Control Center and sign in.

Please get the account information to sign in from Loftware company.

#### 4 Select [Printers] in the tree on the left, and then select [Cloud Printers] - [Add]. NiceLabel Cloud

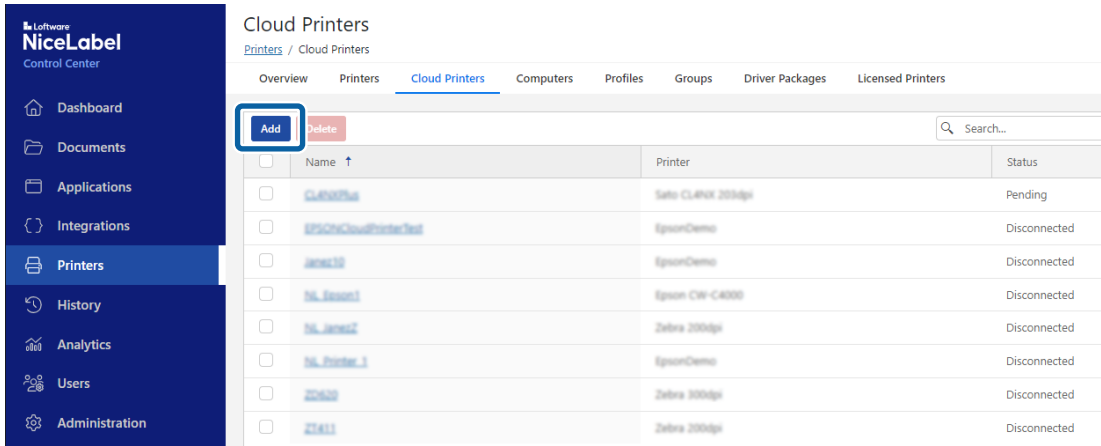

#### 5 Set [Name] and [Printer] for the new cloud printer. NiceLabel Cloud

Cloud Printer Settings

1 Name

2 Printer

Serial number

[Where can you find your printer's serial number?](#)

Server URL

- (1) [Name] Enter the name you want to display on NiceLabel Cloud.
- (2) [Printer] Select the printer to set as a cloud printer.

Printer to be selected	Used printer
Epson CW-C4000	CW-C4000u, CW-C4000e, CW-C4010, CW-C4020, CW-C4030, CW-C4040, CW-C4050

When you select [Printer], [Serial number] and [Server URL] will appear.

## 6 Open [Status] - [Product Status] in WebConfig, copy the serial number of the printer, and paste it into [Serial number] in NiceLabel Cloud.

WebConfig

Status

Product Status

English

Printer Status  
Available.

MK Y M C

Black (MK) :	SJIC43P-MK
Yellow (Y) :	SJIC43P-Y
Magenta (M) :	SJIC43P-M
Cyan (C) :	SJIC43P-C
Maintenance Box :	SJMB4000

Firmware : 06.32.TG25N7

Serial Number : XB36000071

Date and Time : 2023-08-01 19:18 UTC+09:00

Refresh

Software Licenses

NiceLabel Cloud

Overview Printers Cloud Printers Computers Profiles Groups Driver Packages Licensed Printers

Add New Cloud Printer

Cancel Save

Cloud Printer Settings

Name Test\_C...V-C...

Printer Epson...W-C...

Serial number

Where can you find your printer's serial number?

Server URL https://epsoncorp.print.onnicelabel.com



- 7 Click the  button in NiceLabel Cloud, copy the server URL, and paste it into the following field in WebConfig.

[Network] - [NiceLabel Cloud] - [Basic] - [URL]

NiceLabel Cloud

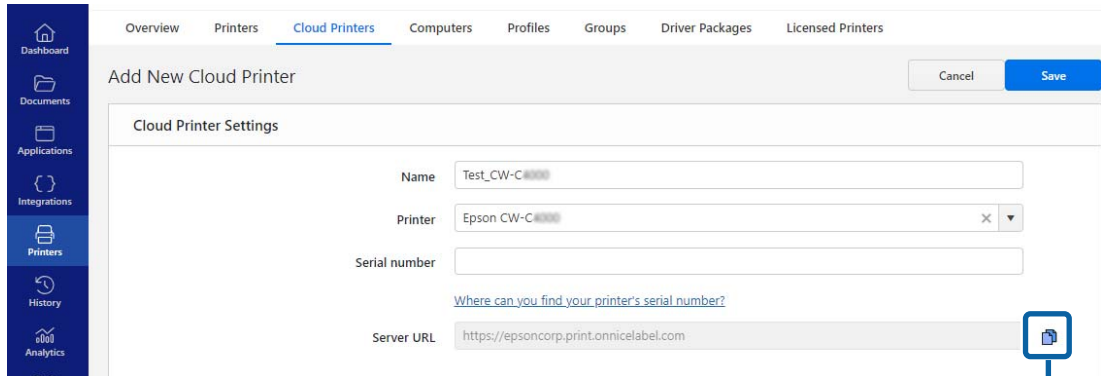

Overview Printers **Cloud Printers** Computers Profiles Groups Driver Packages Licensed Printers

Add New Cloud Printer Cancel Save

Cloud Printer Settings

Name: Test\_CW-C4020

Printer: Epson CW-C4020

Serial number:

[Where can you find your printer's serial number?](#)

Server URL:  

WebConfig

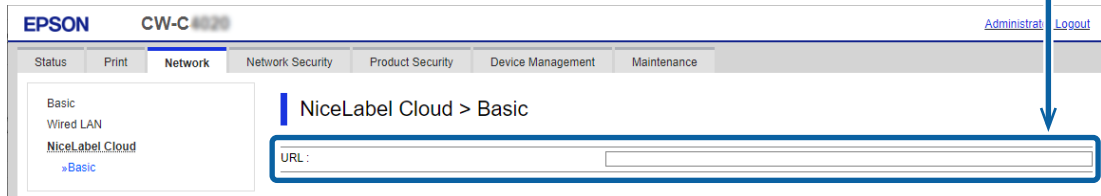

EPSON CW-C4020 Administrator Logout

Status Print **Network** Network Security Product Security Device Management Maintenance

Basic  
Wired LAN  
NiceLabel Cloud  
»Basic

NiceLabel Cloud > Basic

URL:

- 8 Select [Next].

- 9 Check the settings, and then select [OK].

WebConfig

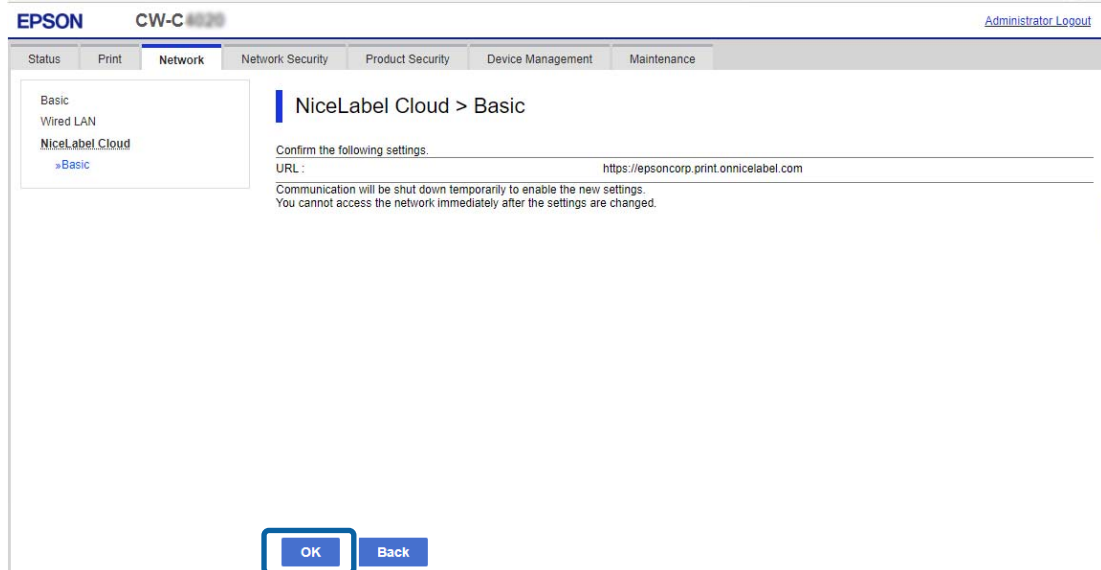

EPSON CW-C4020 Administrator Logout

Status Print **Network** Network Security Product Security Device Management Maintenance

Basic  
Wired LAN  
NiceLabel Cloud  
»Basic

NiceLabel Cloud > Basic

Confirm the following settings.

URL:

Communication will be shut down temporarily to enable the new settings.  
You cannot access the network immediately after the settings are changed.

OK Back

## 10 Return to NiceLabel Cloud and select [Save].

### NiceLabel Cloud

Overview Printers **Cloud Printers** Computers Profiles Groups Driver Packages Licensed Printers

Add New Cloud Printer Cancel **Save**

Cloud Printer Settings

Name

Printer

Serial number

[Where can you find your printer's serial number?](#)

Server URL

If the registered printer is [Connected], registration was successful.

### NiceLabel Cloud

Overview Printers **Cloud Printers** Computers Profiles Groups Driver Packages Licensed Printers

**Add** **Delete**  **Columns** **Filters**

<input type="checkbox"/>	Name ↑	Printer	Status
<input type="checkbox"/>	<a href="#">CL4000Test</a>	Sato CL4000 200dpi	Pending
<input type="checkbox"/>	<a href="#">cw-c4000-test</a>	Epson CW-C4000	Pending
<input type="checkbox"/>	<a href="#">Test_CW-C4000</a>	Epson CW-C4000	Connected
<input type="checkbox"/>	<a href="#">EPSONCloudPrinterTest</a>	EpsonDemo	Disconnected
<input type="checkbox"/>	<a href="#">JANUS10</a>	EpsonDemo	Disconnected
<input type="checkbox"/>	<a href="#">DSE-400</a>	Epson CW-C4000	Disconnected
<input type="checkbox"/>	<a href="#">NL_Epson1</a>	Epson CW-C4000	Disconnected
<input type="checkbox"/>	<a href="#">NL_Zebra2</a>	Zebra 200dpi	Disconnected
<input type="checkbox"/>	<a href="#">test_cw4000</a>	Epson CW-C4000	Connected
<input type="checkbox"/>	<a href="#">Z2000</a>	Zebra 300dpi	Disconnected
<input type="checkbox"/>	<a href="#">Z2411</a>	Zebra 200dpi	Disconnected

Your partner ◀ 1 ▶ 20 items per page 1 - 11 of 11 items

## Registering a Printer (Epson Device Admin)

### 1 Open Epson Device Admin, and select [Device Configuration]. Epson Device Admin

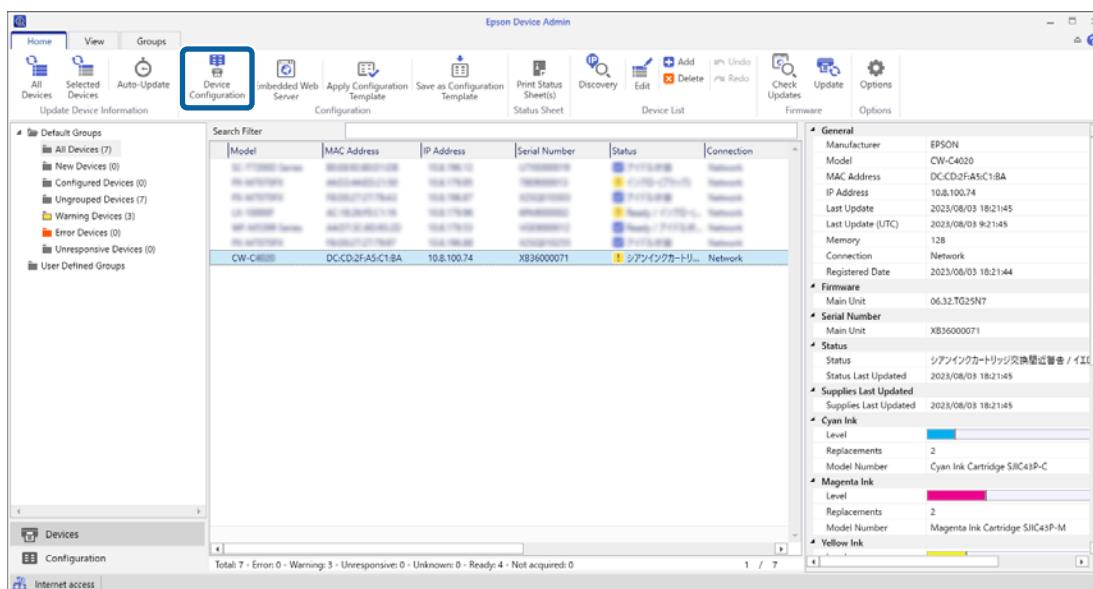

For details on Epson Device Admin, "[Epson Device Admin](#)" on page 244.

The initial administrator password is either the serial number of the printer or the character string on the password label applied to the rear of the printer.

## 2 Check the following settings on the "Device Properties" screen.

- IP Address
- Subnet Mask
- Default Gateway
- Primary DNS Server
- Secondary DNS Server
- Proxy Server
- Proxy Server Port Number

[Network] – [TCP/IP] – [Basic]

Method for Specifying IP Address

Automatic  Manual

Set using BOOTP

Set using Automatic Private IP Addressing (APIPA)

IP Address Setting

IP Address: 10 . 0 . 0 . 24

Subnet Mask: 255 . 255 . 252 . 0

Default Gateway: 10 . 0 . 0 . 1

[Network] – [TCP/IP] – [DNS]

DNS Server Address Settings

Acquire DNS server address automatically

DNS Server Addresses (order of use):

10.0.0.1

10.0.0.255

Add... Edit... Delete Up Down

[Network] – [TCP/IP] – [Internet]

Use proxy server

Proxy Server

Address: 10.0.0.255

Port: 8080

Acquire from browser information.

## 3 Open NiceLabel Control Center and sign in.

Please get the account information to sign in from Loftware company.

## 4 Select [Printers] in the tree on the left, and then select [Cloud Printers] - [Add]. NiceLabel Cloud

The screenshot shows the 'Cloud Printers' management page in the NiceLabel Cloud Control Center. The 'Add' button is highlighted with a blue box. The table below lists several printers:

Name	Printer	Status
C4000u	Sato CL40X 200dpi	Pending
EPSONCloudPrinteTest	EpsonDemo	Disconnected
4000u	EpsonDemo	Disconnected
NL_Epson1	Epson CW-C4000	Disconnected
NL_Zebra2	Zebra 200dpi	Disconnected
NL_Printer_1	EpsonDemo	Disconnected
2000u	Zebra 200dpi	Disconnected
20411	Zebra 200dpi	Disconnected

## 5 Set [Name] and [Printer] for the new cloud printer. NiceLabel Cloud

The 'Cloud Printer Settings' form includes the following fields:

- Name:** TEST\_CW-C4000
- Printer:** Epson CW-C4000
- Serial number:** (empty)
- Server URL:** https://epsoncorp.print.onniclabel.com

- (1) [Name] Enter the name you want to display on NiceLabel Cloud.
- (2) [Printer] Select the printer to set as a cloud printer.

Printer to be selected	Used printer
Epson CW-C4000	CW-C4000u, CW-C4000e, CW-C4010, CW-C4020, CW-C4030, CW-C4040, CW-C4050



When you select [Printer], [Serial number] and [Server URL] will appear.

## 6 Open Epson Device Admin, find the serial number of the printer, and enter it into [Serial number] in NiceLabel Cloud.

Epson Device Admin

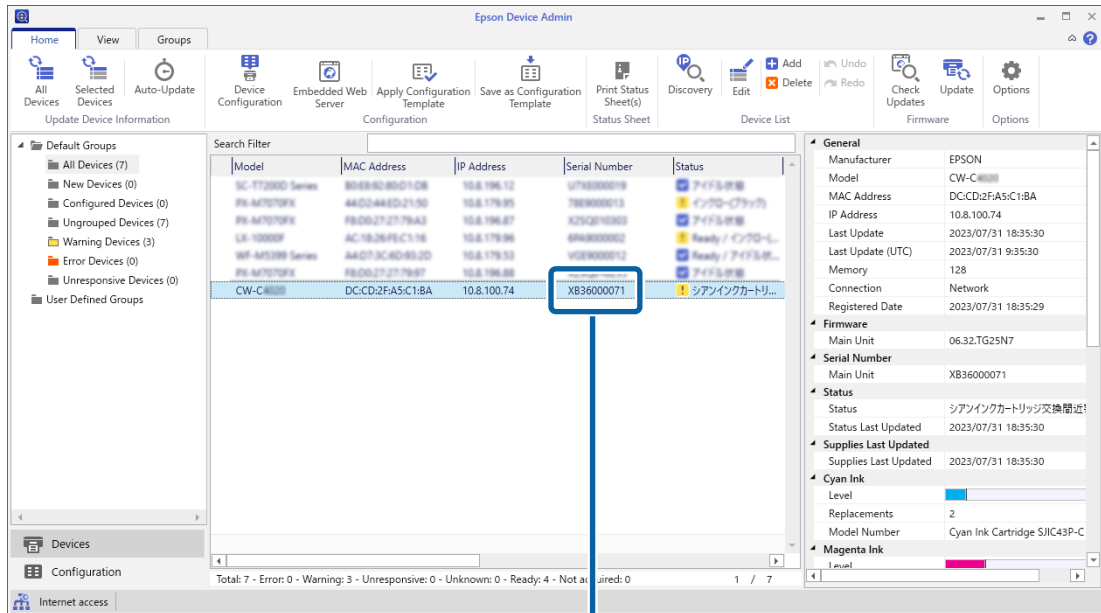

## NiceLabel Cloud

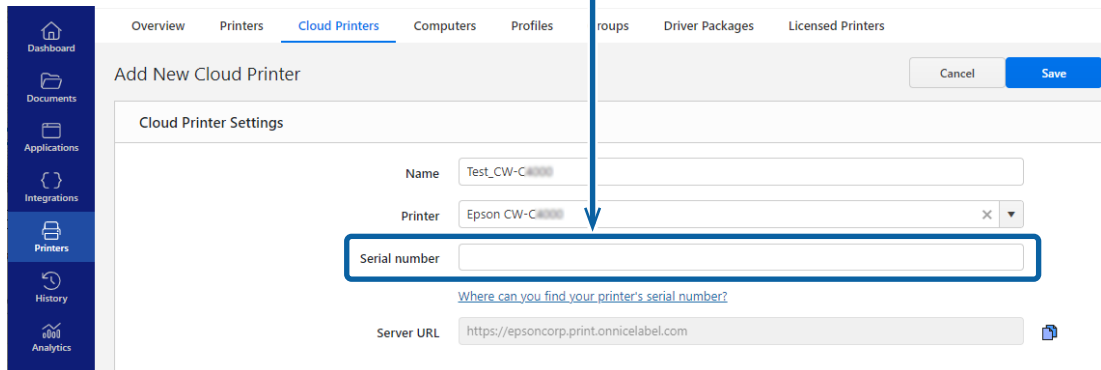

## 7 Click the button in NiceLabel Cloud, copy the server URL, and paste it into the following field in Epson Device Admin.

[Device Configuration] - [Print / Copy] - [Label] - [NiceLabel Cloud] - [URL]

### NiceLabel Cloud

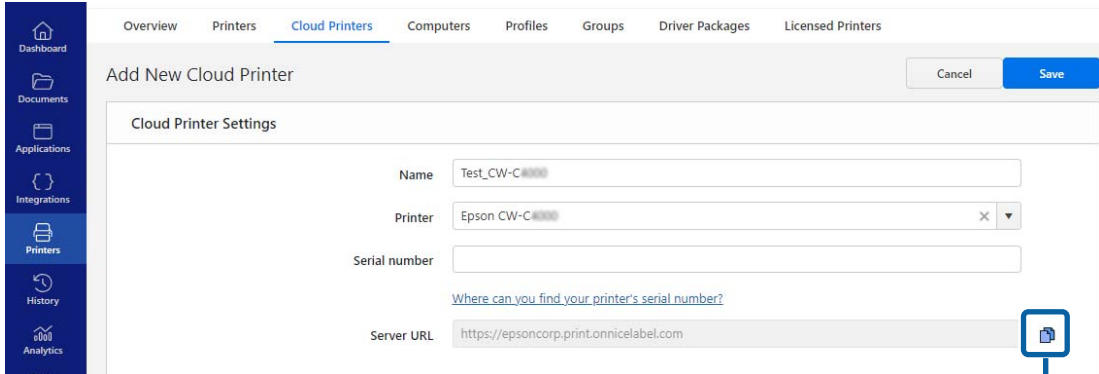

Overview Printers **Cloud Printers** Computers Profiles Groups Driver Packages Licensed Printers

Add New Cloud Printer Cancel Save

Cloud Printer Settings

Name

Printer  × ▼

Serial number

[Where can you find your printer's serial number?](#)

Server URL  

### Epson Device Admin

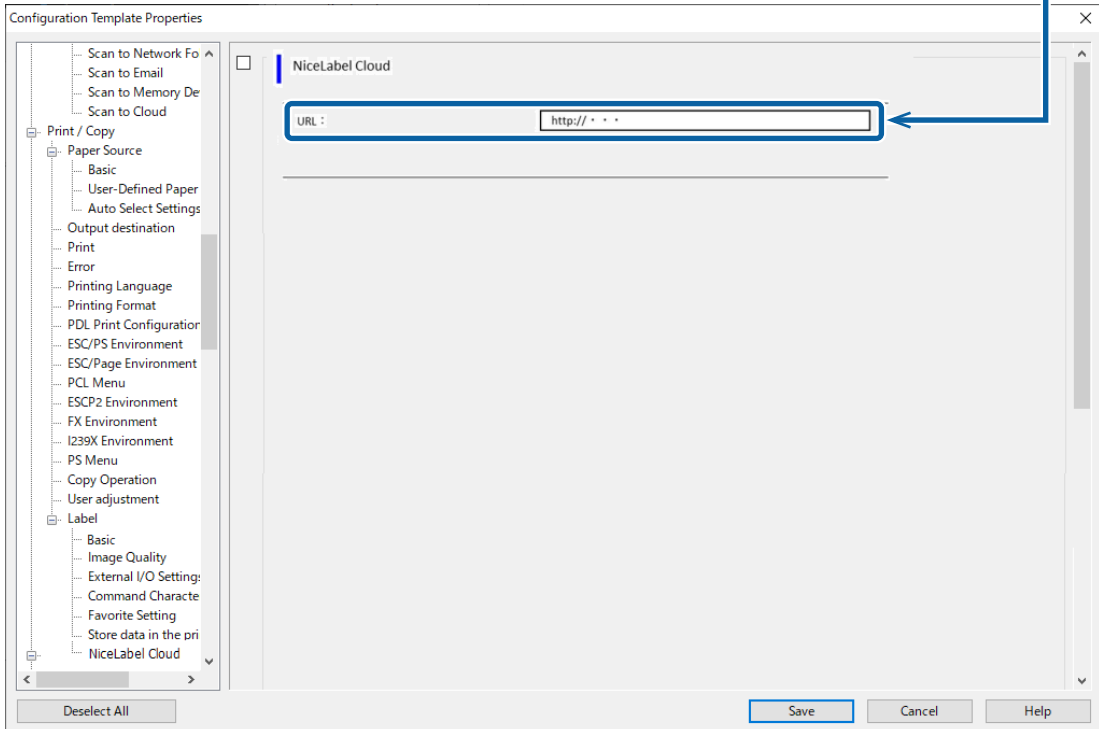

Configuration Template Properties ×

- Scan to Network Fo
- Scan to Email
- Scan to Memory De
- Scan to Cloud
- Print / Copy
  - Paper Source
    - Basic
    - User-Defined Paper
    - Auto Select Settings
  - Output destination
  - Print
  - Error
  - Printing Language
  - Printing Format
  - PDL Print Configuration
  - ESC/PS Environment
    - ESC/Page Environment
    - PCL Menu
    - ESCP2 Environment
    - FX Environment
    - I239X Environment
  - PS Menu
  - Copy Operation
  - User adjustment
- Label
  - Basic
  - Image Quality
  - External I/O Setting
  - Command Characte
  - Favorite Setting
  - Store data in the pri
  - NiceLabel Cloud

NiceLabel Cloud

URL :

Deselect All Save Cancel Help

## 8 Select [Save].

## 9 Return to NiceLabel Cloud and select [Save]. NiceLabel Cloud

Overview Printers **Cloud Printers** Computers Profiles Groups Driver Packages Licensed Printers

Add New Cloud Printer Cancel **Save**

Cloud Printer Settings

Name

Printer  X ▾

Serial number   
[Where can you find your printer's serial number?](#)

Server URL

If the registered printer is [Connected], registration was successful.  
NiceLabel Cloud

Overview Printers **Cloud Printers** Computers Profiles Groups Driver Packages Licensed Printers

**Add** **Delete**  **Columns** **Filters**

<input type="checkbox"/>	Name ↑	Printer	Status
<input type="checkbox"/>	<a href="#">CL4000Test</a>	Sato CL400 200dpi	Pending
<input type="checkbox"/>	<a href="#">cw-c4000.test</a>	Epson CW-C4000	Pending
<input type="checkbox"/>	<a href="#">Test_CW-C4000</a>	Epson CW-C4000	Connected
<input type="checkbox"/>	<a href="#">EPSONCloudPrinterTest</a>	EpsonDemo	Disconnected
<input type="checkbox"/>	<a href="#">JANUS10</a>	EpsonDemo	Disconnected
<input type="checkbox"/>	<a href="#">out.ink</a>	Epson CW-C4000	Disconnected
<input type="checkbox"/>	<a href="#">NL_Epson1</a>	Epson CW-C4000	Disconnected
<input type="checkbox"/>	<a href="#">NL_Zebra1</a>	Zebra 200dpi	Disconnected
<input type="checkbox"/>	<a href="#">test.onnicel</a>	Epson CW-C4000	Connected
<input type="checkbox"/>	<a href="#">22630</a>	Zebra 200dpi	Disconnected
<input type="checkbox"/>	<a href="#">27431</a>	Zebra 200dpi	Disconnected

Your partner ◀ 1 ▶ 20 items per page 1 - 11 of 11 items



## Spot Color Settings

[Spot Color Settings] allows you to change a specified color to another specified color. First create the color conversion setting file, then when printing, specify the setting file to print with the color conversion applied. Follow the procedure below to create the color conversion setting file.



The printer converts all the portions of print data that use the specified RGB settings into the target color. If unintended portions are converted into the target color, slightly change the RGB settings of the portions to make them not to be converted.

### Creating Spot Color Setting File

#### 1 Check the RGB settings of a color you want to convert into another color in the print data.

The check method for Microsoft Paint is explained here as an example.

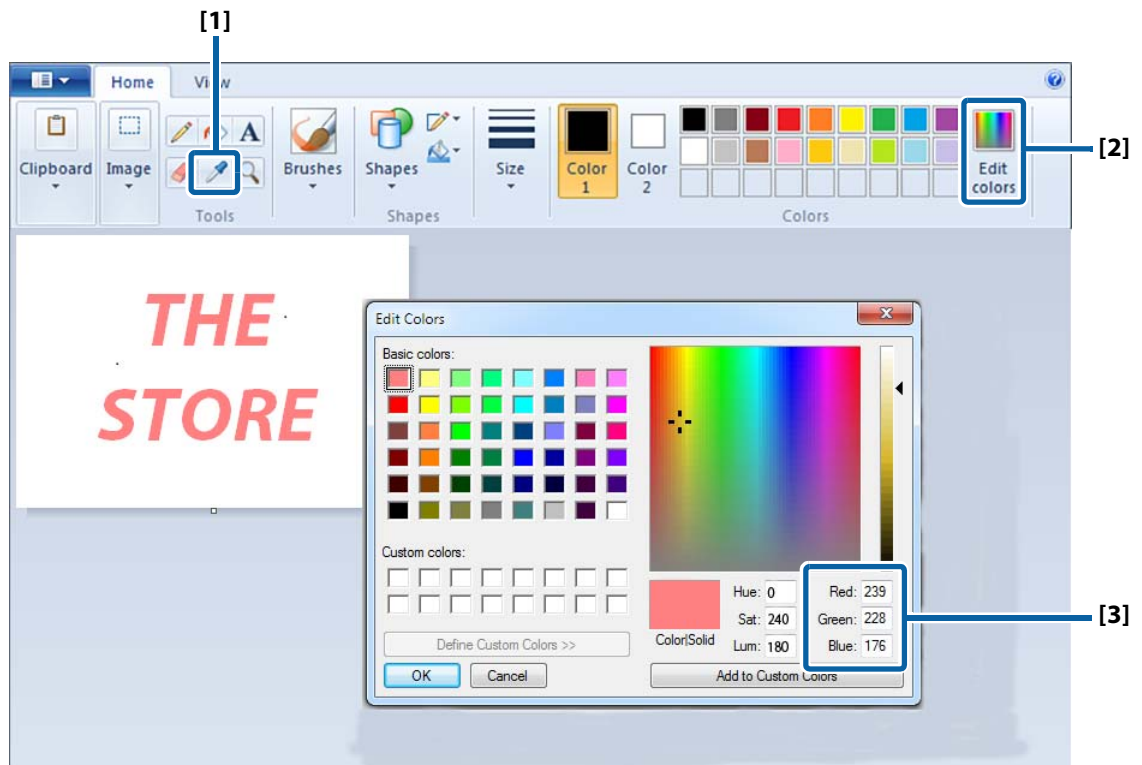

[1] Select the Picker tool, and then click on a color you want to check.

[2] Click the [Edit Colors] button to display the Edit Colors window.

[3] Check the RGB settings of the selected color, and write them down.



The method to check the RGB settings differs by graphic software to another. See the manual or help of the software you use.

## 2 Determine RGB settings of a target color.



To determine the target color, it is recommended to use "Color Tone Matching Assistant" bundled in the included software disc.

Color Tone Matching Assistant lets you enter the RGB settings of the original color, creates some sample colors by slightly changing the original RGB settings, and then lets you print the samples. You can choose a target color and know its RGB settings on the printout. For more details, see "Color Tone Matching Assistant User's Guide".

Color Tone Matching Assistant

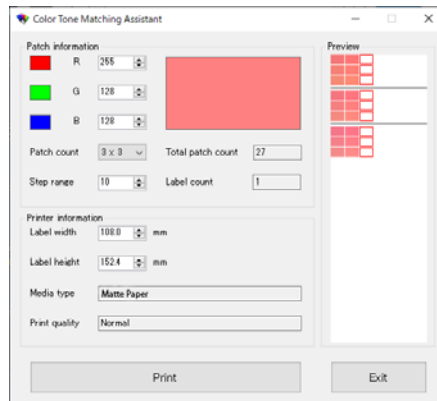

Example of the Sample Colors

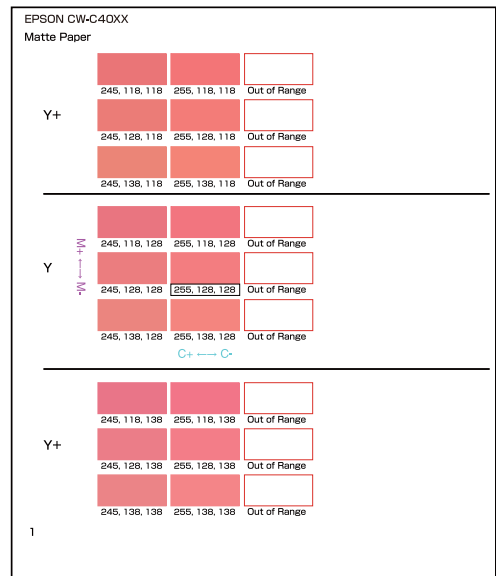

If you have set font replacement, the sample pattern in the Color Tone Matching Assistant may not be printed normally. Unset font replacement and then print.

## 3 Start PrinterSetting. ("How to Start PrinterSetting" on page 190)

- 4 Select [Store data in the printer].
- 5 Click [Create] button in the [Spot color table] field.

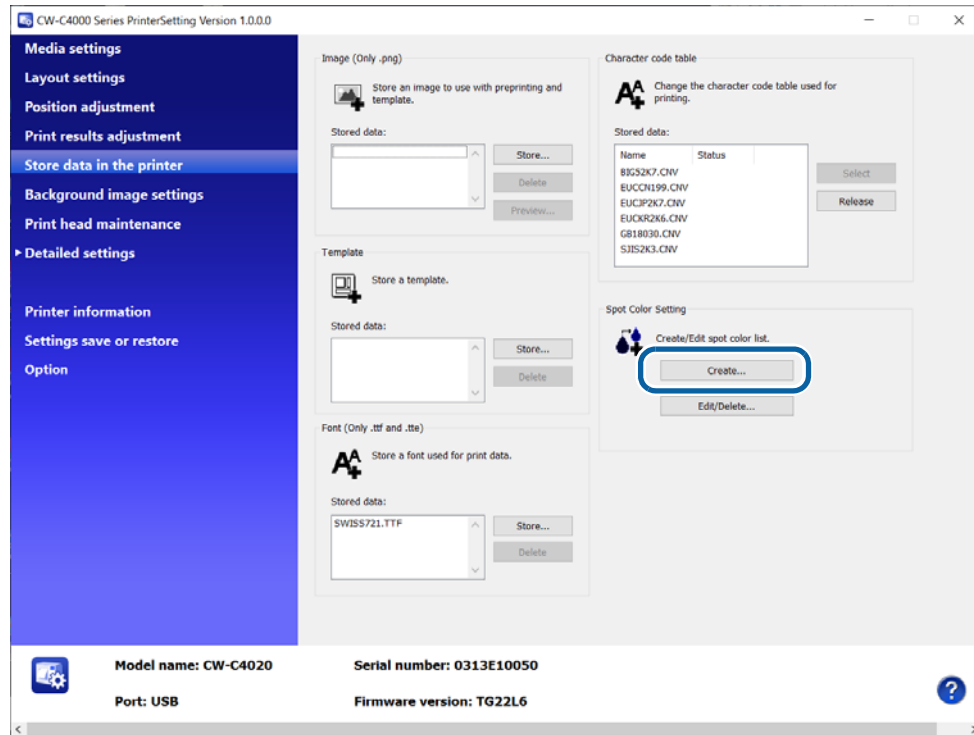

- 6 Enter the original RGB settings and the target RGB settings.

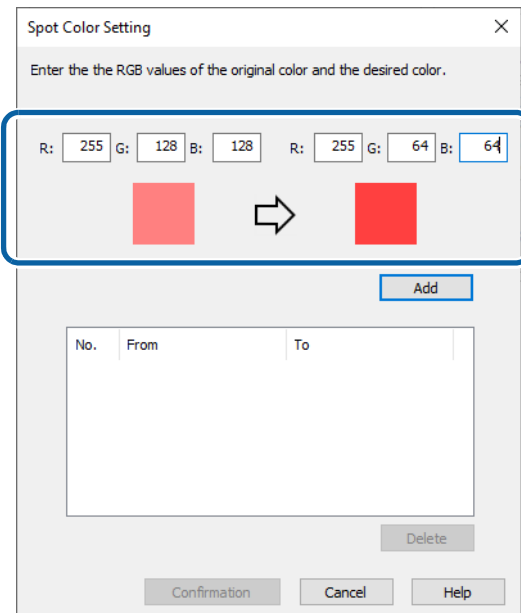

- 7 Click [Add].**  
The specified pair of RGB settings will be added in the box.

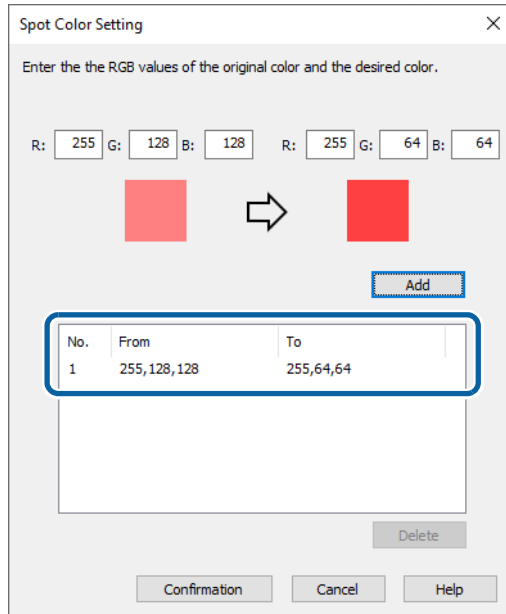

- 8 Click [Confirmation].**  
A window to enter a name for the spot color setting is displayed.

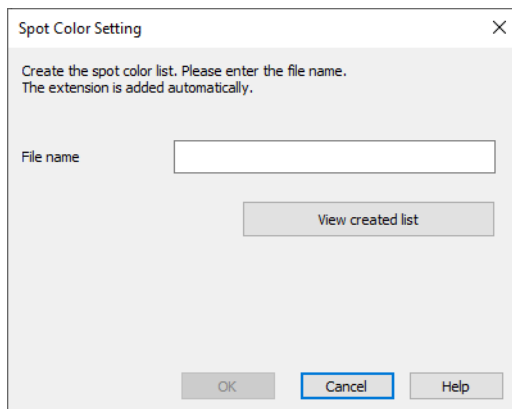

- 9 Enter a name for the setting file, then click [OK].**

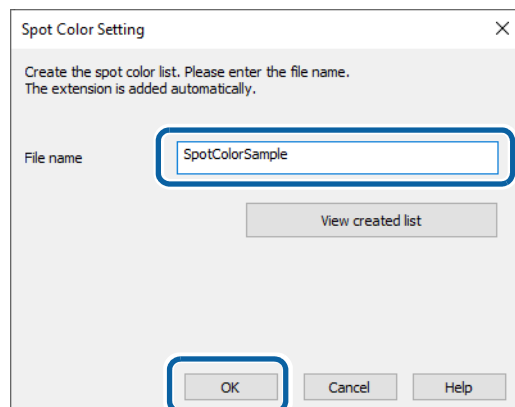

- 10** When you select [OK] on a successfully saved dialog box, the [Created spot color list] window appears.

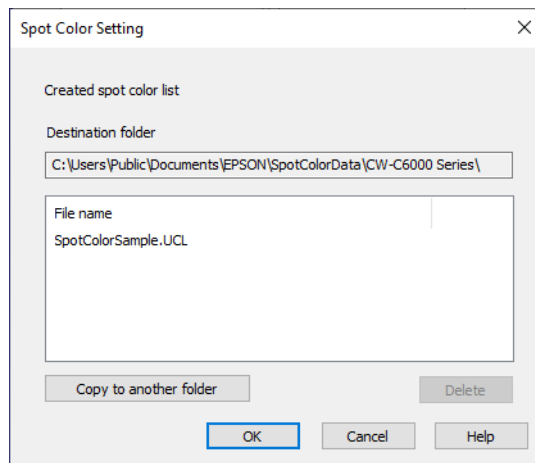

If you want to copy the file to another location, click [Copy to another folder].

Creating spot color setting file is now complete.

## Printing using the Spot Color Setting File

- 1 Open the printer driver window.
- 2 Select [Spot Color Settings] on the [General] window.

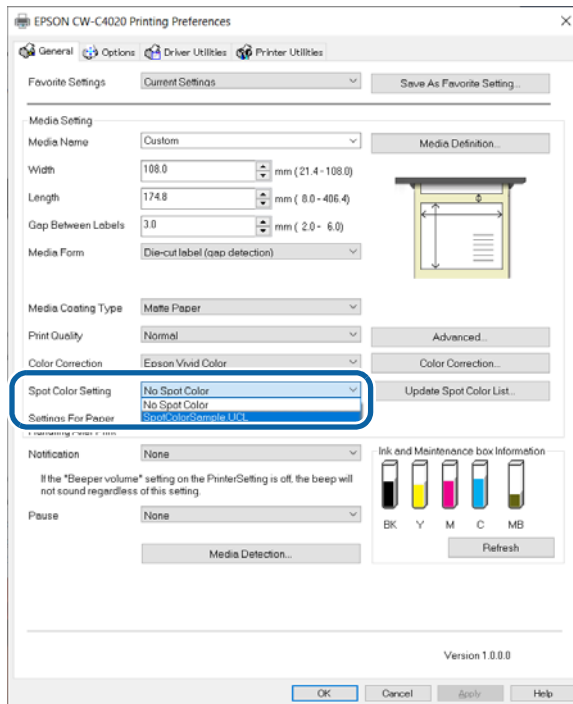

- 3 From the pull-down menu, select a spot color setting file you want to use.



To change the folder to view, click [Update Spot Color List] and change the folder.

- 4 **Print the file.**  
The printer driver prints the file after performing the color conversion as specified in the setting file.

Printing using the spot color setting file is now complete.

## Color Correction

There are the following three methods for color correction.

- Setting on the printer
- Setting using OS
- Setting using an application software

According to which method you use, set [Color Correction Mode] of the printer driver as follows.

- Setting on the printer: Set to [Vivid colors]
- Setting using OS: Set to [ICM] for Windows, Set to [ColorSync] for Mac
- Setting using an application software: Set to [No composite]

### Relationship Between Driver Settings, Color Correction Methods, and Spot Color Settings

The color of the print result varies depending on the menu settings on the driver.

There are two menus on the driver for changing the color of the print result: [Color Correction] and [Spot Color Settings].

[Color Correction] changes the overall color, and there are color correction engines in the printer, in the OS, and in certain applications. The selections in the [Color Correction] menu on the driver specify which color correction engine to use, and pass the input parameters to each color correction engine.

[Spot Color Settings] replaces the specified specific color (= the original color) with another color (= the target color), and there is a color replacement engine in the driver.

You can only select one selection in the [Color Correction] menu. Therefore, the color correction engines in the printer, in the OS, and in a particular application are not used simultaneously. Only one color correction engine is used.

[Color Correction] and [Spot Color Settings] can be used in combination with one another simultaneously. However, you can actually use [Spot Color Settings] simultaneously, but only in cases where you select [Epson vivid color] or [Epson preferred color] for [Color Correction] and use the color correction engine in the printer. This is because if color correction is performed first in the application or OS, which are higher layers than the driver, and the RGB value of the specified original color will be changed. The color substitution engine for spot colors is in the driver and therefore will not be able to find the color in places where it should be changed.

Therefore, when [Color Correction] is set to [ICM] or [None], it cannot be combined with [Spot Color Settings] for simultaneous color correction.

Setting on the driver		Where to reflect the driver setting
Menu	Selection	
Color Correction	Epson vivid color	Printer color correction engine
	Epson preferred color	Printer color correction engine
	ICM	OS color correction engine
	None	None = assumed to be adjusted by the application
Spot color setting	Spot color not set	None
	File name of the spot color list	Driver spot color replacement engine

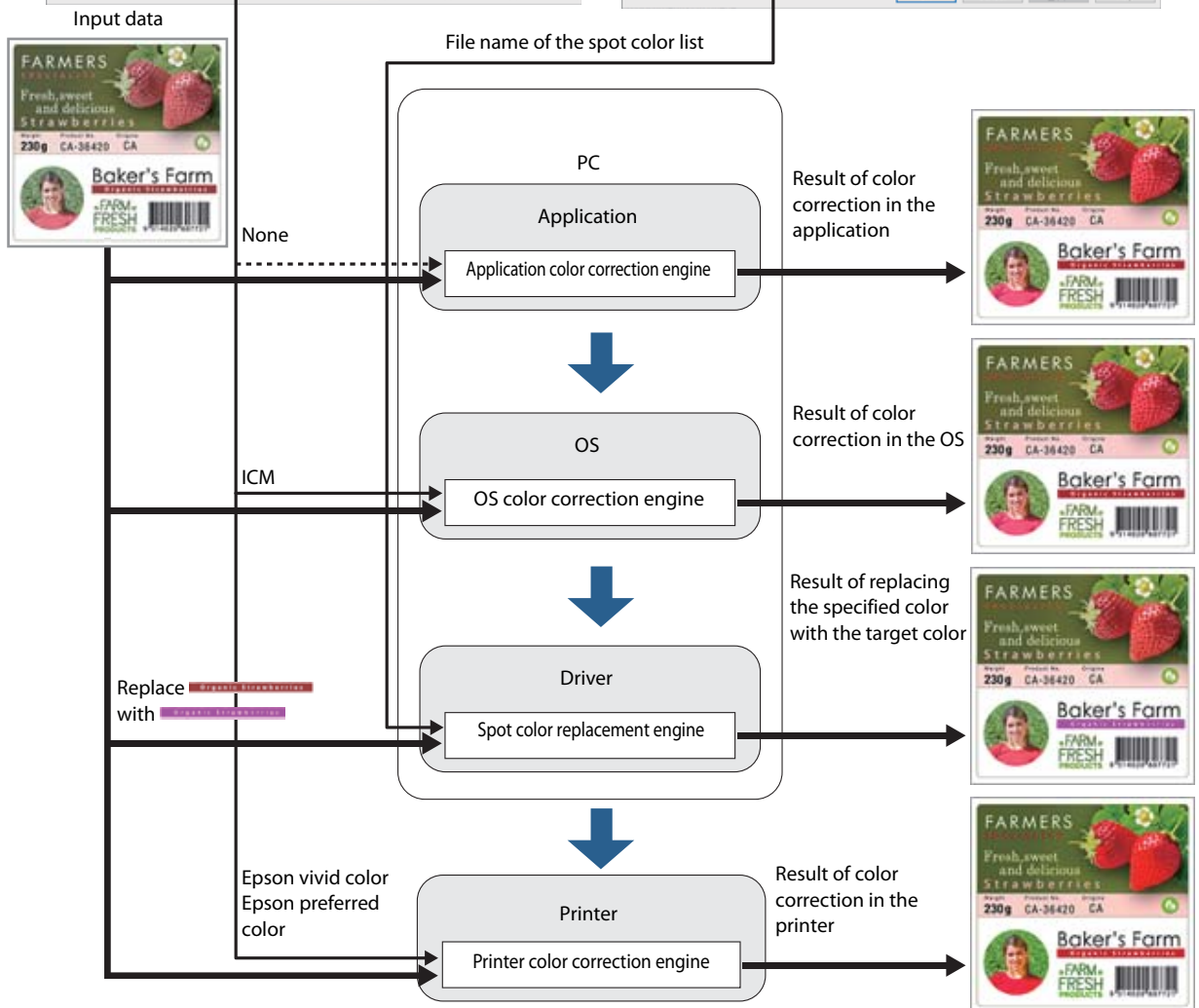
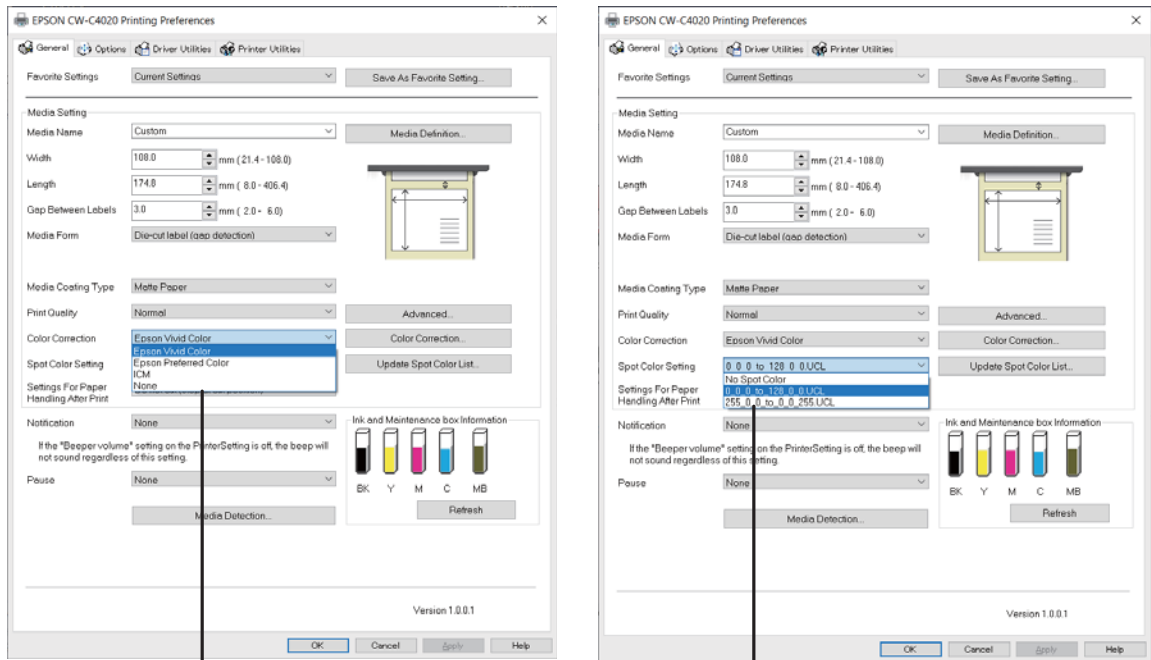

**CAUTION**  The image data is a representation of the concept of color correction, and is not the actual data before and after color correction.



## Setting on the Printer

### Epson Vivid Color

“Epson Vivid Color” conforms to the Adobe RGB color space for images, which has a wider color reproduction range than sRGB, but in order to bring the colors of the print result closer to the monitor, you need to prepare a monitor that is compatible with Adobe RGB.

### Epson Preferred Color

“Epson Preferred Color” conforms to the sRGB color space for images. The color reproduction range is narrower than Adobe RGB, but the colors of printed results are close to those shown on common monitors. This is the same color correction method as TM-C3500, so select this option when you want to replace printer from TM-C3500 without changing the output result.

There are more restrictions on the combination of paper type and print quality compared to “Epson Vivid Color”.

#### Restrictions when using Epson Preferred Color

The “Epson Preferred Color” option is only available with the following paper types and print quality combinations.

	Max Speed	Speed	Normal	Quality	Max Quality
Plain paper	✓	✓	-	-	-
Matte paper	-	✓	✓	-	-
Synthetic paper	-	✓	✓	-	-
Texture paper	-	-	-	-	-
Wristband paper	-	✓	-	-	-
Glossy paper	-	-	✓	-	-
Glossy film	-	-	-	-	-
High glossy paper	-	-	-	-	-

## Correction Method

If you select [Epson Vivid Color] or [Epson Preferred Color] from the [Color Correction] menu, and click the [Color Correction] button, the [Color Correction] window is displayed.

Adjust the color as desired comparing the “Original Picture” image and the “Preview” image.

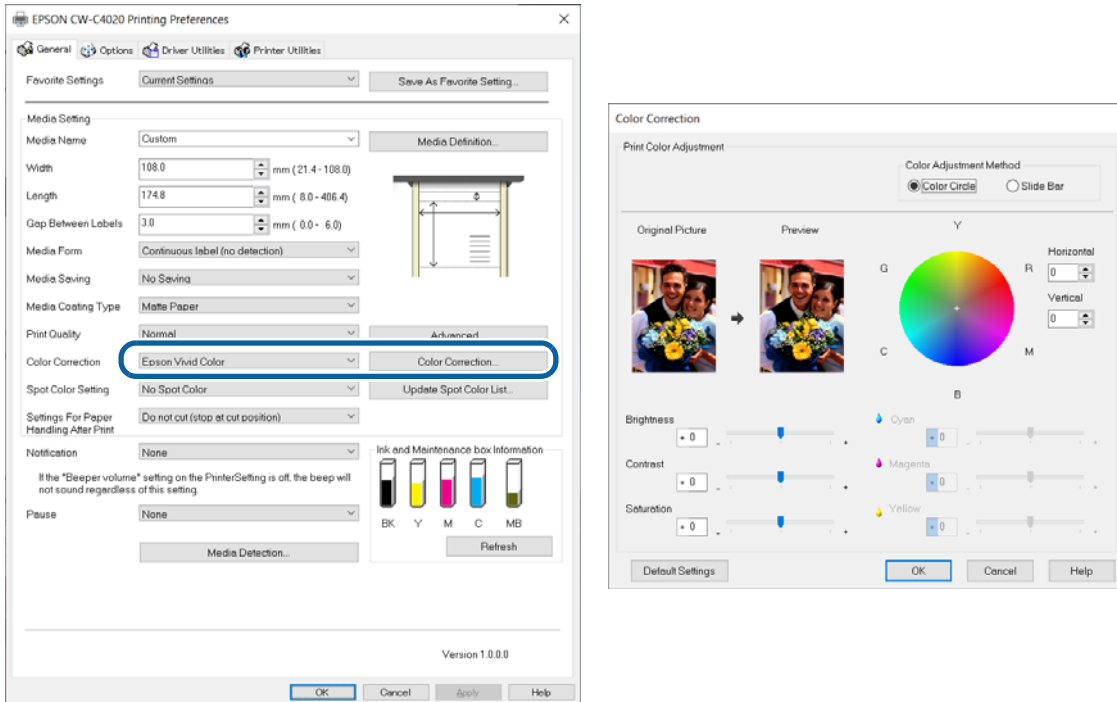

Item		Description
Brightness		Lets you adjust brightness of the entire image.
Contrast		Adjust the contrast of the entire image. When the contrast is increased, bright portions become more bright, and dark portions become more dark. When the contrast is decreased, difference between light and dark is reduced.
Saturation		Lets you adjust saturation (vividness) of the entire image. When the saturation is increased, the feel of the vividness of the image is increased. The more the saturation is decreased, the more the image becomes achromatic closing to gray.
Color Adjustment Method	Color Circle	Click on the circle to adjust the color. You can also adjust color by entering values in the [Horizontal and [Vertical] boxes.
	Slide Bar	You can move the Cyan, Magenta, and Yellow slide bars to adjust color.

## Setting using OS

### ICM

ICM (Image Color Management) is a Windows color control function to match apparent color between different devices such as a monitor and a printer. Apparent color on the monitor and on the printout is matched based on ICC profiles.

An ICC profile is a file that describes characteristics of the device such as a monitor and a printer according to ICC (International Color Consortium) standards.

However, since the color space of a four-color printer is narrow comparing to that of a monitor, it is impossible to accurately match colors on the monitor with printouts.

When you click the [Color Correction] button with [ICM] selected, the ICM window appears.

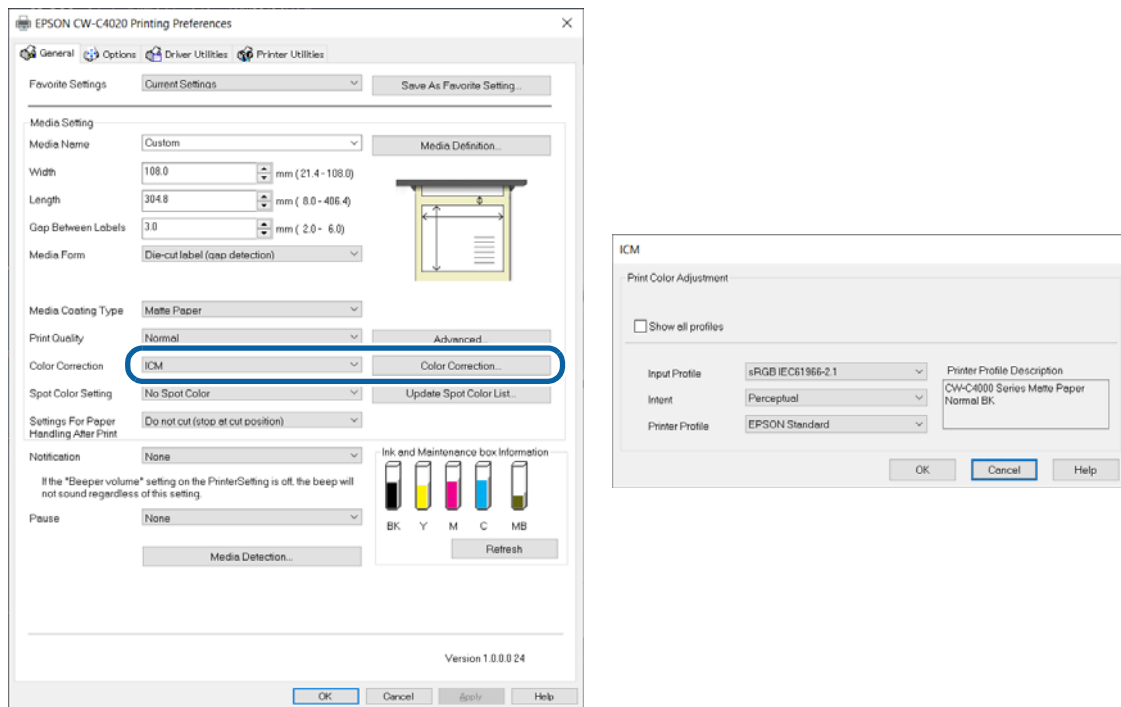

Item	Description
Show all profiles	<p>When the printer driver is installed, ICC profiles for Epson genuine paper are also installed. The ICC profiles include all combinations of [Media Coating Type] and [Print Quality] for each Epson paper.</p> <p>Since the check box for this item is not checked by default, the [Input Profile] setting is fixed to [sRGB IEC61966-2-1], and the [Printer Profile] setting is fixed to [EPSON Standard]. With the default settings, one of the ICC profiles for Epson paper is automatically selected according to the [Media Coating Type] and [Print Quality] settings.</p> <p>Select this check box when using paper other than Epson genuine paper and you have installed an ICC profile for the paper.</p> <p>When the check box is selected, the pull-down menu of [Input Profile] and [Printer Profile] shows all profiles installed on the system. Select the target ICC profile from the [Printer Profile] menu.</p>

Item		Description
Input Profile		Select a profile for a display device. Normally, only "sRGB IEC61966-2-1", which is the default of Windows OS, is displayed.
Intent	Saturation	Color is converted keeping the saturation.
	Perceptual	Color is converted keeping natural-looking image. Select this when color space of the image is wide.
	Relative Colorimetric	Color is converted so that chromatic coordinate between the original data and the print data matches, and the white point (color temperature) also matches between them. This method is used a lot for color matching.
	Absolute Colorimetric	Color is converted assigning both the original and print data to absolute chromatic coordinate. The white point (color temperature) of the original and print data is not corrected. Use this method to print an image that has a specific color such as a corporate logo.
Printer Profile		Select a printer profile that matches the media you use. Normally, only [EPSON Standard] is displayed. [EPSON Standard] automatically selects an ICC profile for Epson genuine paper that matches the [Media Coating Type] and [Print Quality] settings on the printer driver.

## ColorSync

“ColorSync” is a Color Matching engine on macOS. That is similar to ICM on Windows.

The following describes how to set an ICC profile using ColorSync taking Adobe Photoshop (hereafter, Photoshop) and other popular apps as examples.

### The case of the printing from Photoshop

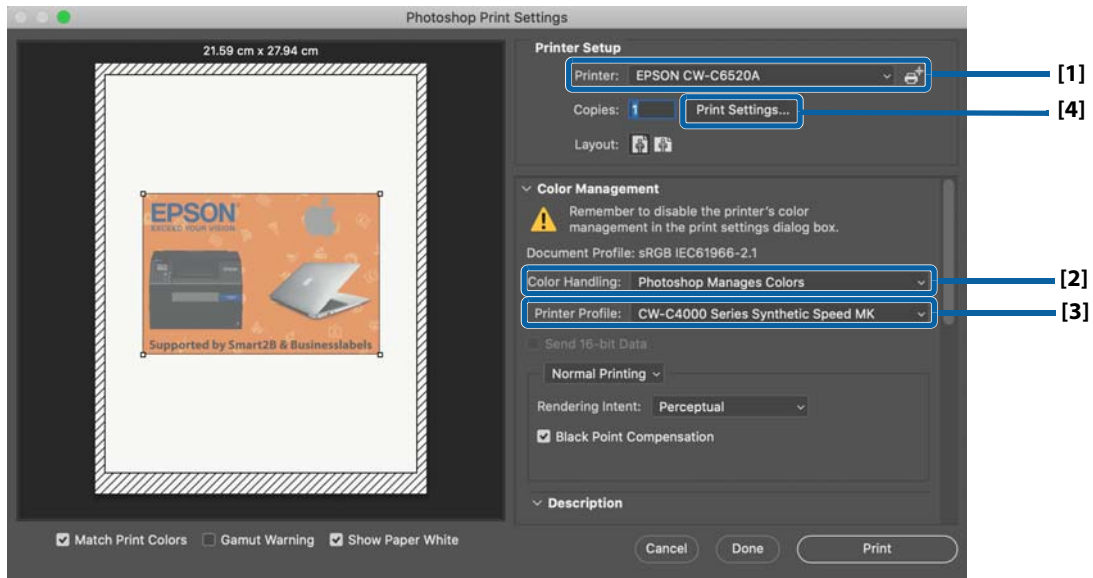

- 1 Select the printer queue to [Printer] menu.
- 2 Select [Photoshop Managed Color] to [Color Handling] menu.  
You cannot get the printing output with the color matching, if you select [Printer Managed Colors].
- 3 Select the suitable output ICC profile to [Printer Profile] menu.
- 4 Click [Print Settings], then select the print settings of the printer driver.  
The controls on [Color Matching] and [Color Options] are fixed, and you cannot change those.

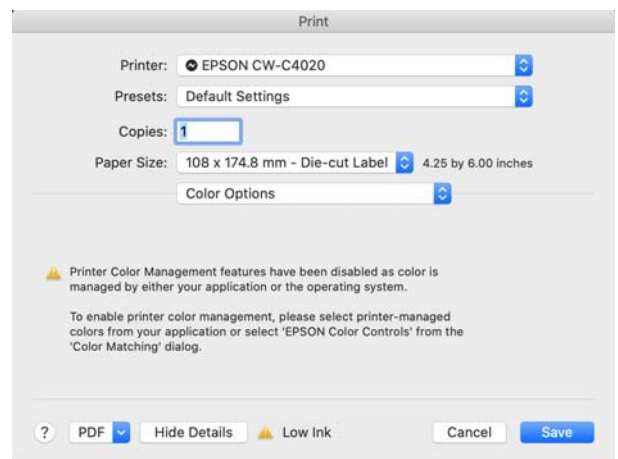
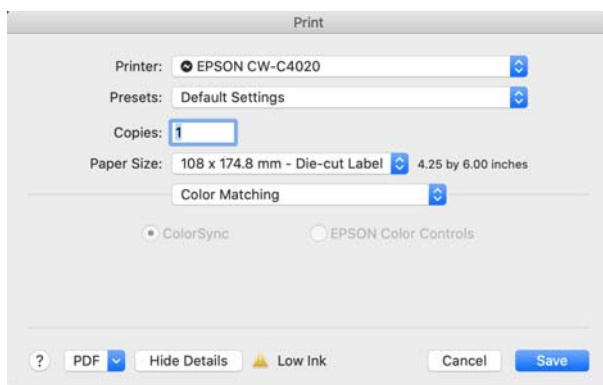

- 5 Select other print settings of Photoshop print window.
- 6 Click [Print] button.

### The case of the printing from Preview

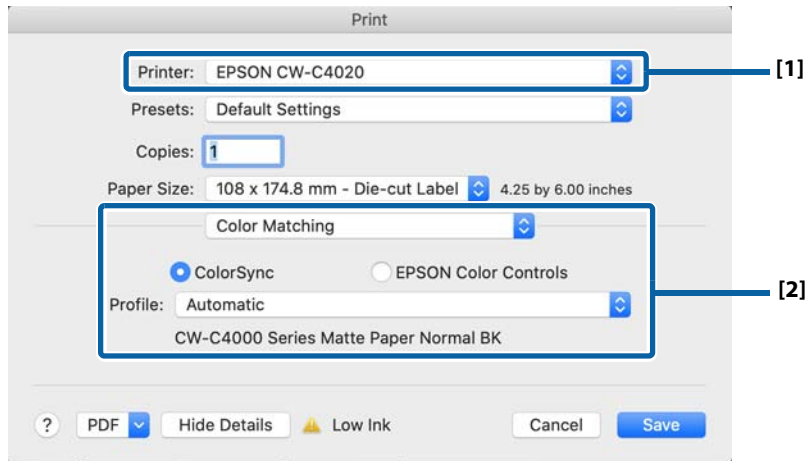

- 1 Select the printer queue to [Printer] menu.
- 2 Select [ColorSync] on [Color Matching] pane, then select the suitable output ICC profile to [Profile] menu.

The suitable output ICC profile provided by Epson is selected automatically, when you select [Automatic]. Select [Other Profiles] to open the [Select ColorSync Profile] window. You can select other output ICC profile by that window.

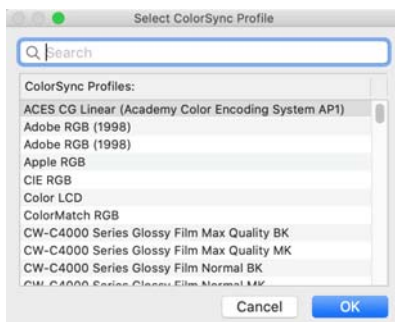

- 3 Select other print settings of the printer driver.
- 4 Click [Print] button.

## The case of the printing from Acrobat Reader



### Notes on using ColorSync

- The PDF data must be RGB data. CMYK data cannot be corrected properly.
- If a source profile (input profile) has not been embedded in the print data, “sRGB IEC61966-2.1” is automatically applied as the source profile.
- The rendering intent is fixed to “Perceptual”.

- 1 Select the printer in [Printer], and then click [Printer...] at the bottom of the screen.

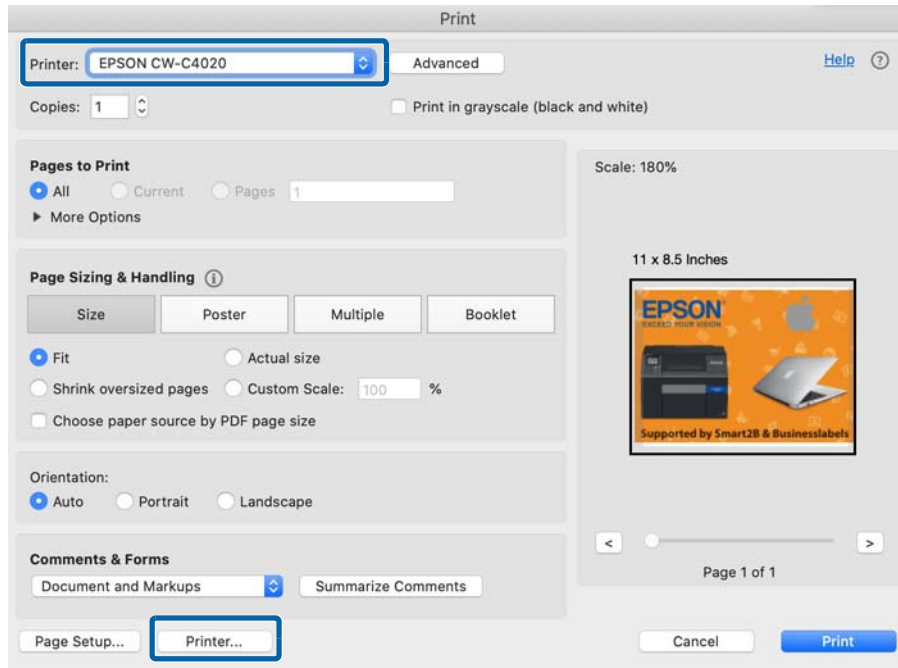

- 2** Select [ColorSync] as the [Color Matching] option, and then select a proper ICC profile in [Profile].

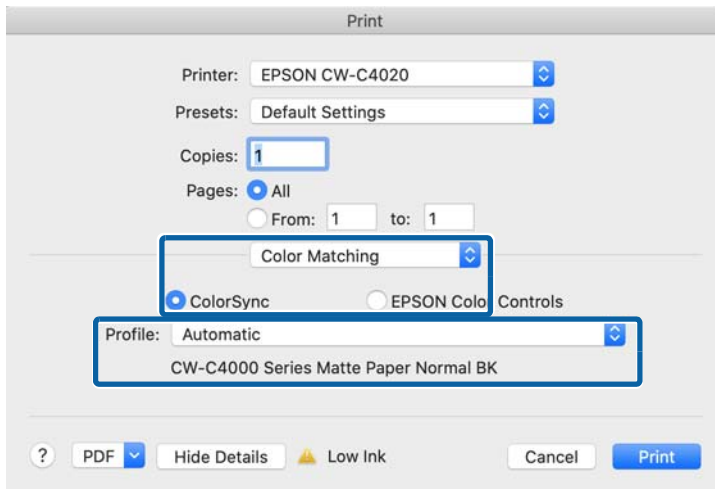

The default profile setting is [Automatic] which automatically selects an ICC profile provided by Epson.

Select [Other Profiles...] to display the ColorSync profile selection screen and select a target ICC profile by yourself.



- 3** Select other print settings.



## 4 Click [Advanced].

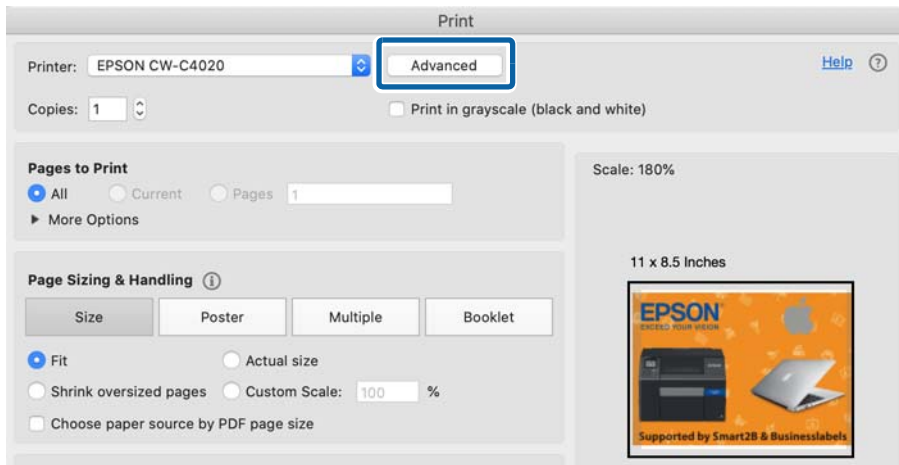

## 5 Select the checkbox for [Print As Image], and then click [OK].

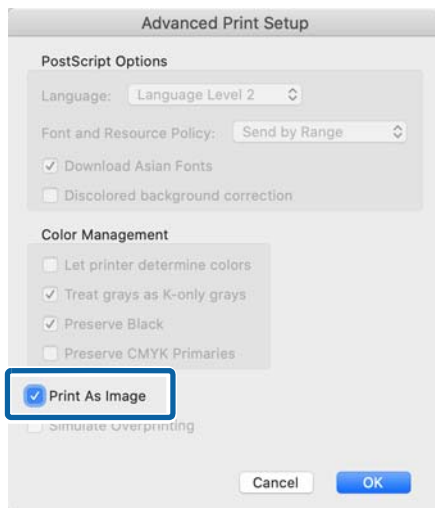

## 6 On the [Print] screen, click the [Print] button.

## ICC Profile

### What is ICC Profile?

An ICC profile is a file (file extension is .icc) that describes information for controlling colors according to the International Color Consortium (ICC) definition. Printout colors change significantly depending on the paper type and print mode.

CW-C4000 Series offer you the ICC profiles for each Epson genuine paper covering all combinations of paper types and print quality settings (print mode). The ICC profiles are stored in the folder shown below when the Windows printer driver is installed.

C:\Windows\System32\spool\drivers\color

If you use paper other than Epson genuine paper, you need to prepare an ICC profile for the paper by yourself.

### ICC Profiles provided for CW-C4000 Series

Media Name	Print Quality	Ink Type	ICC Profile Name	
Plain Paper	Max Speed	Gloss	CW-C4000Series_PlainPaper_MaxSpeed_BK.icc	
		Matte	CW-C4000Series_PlainPaper_MaxSpeed_MK.icc	
	Speed	Gloss	CW-C4000Series_PlainPaper_Speed_BK.icc	
		Matte	CW-C4000Series_PlainPaper_Speed_MK.icc	
	Normal	Gloss	CW-C4000Series_PlainPaper_Normal_BK.icc	
		Matte	CW-C4000Series_PlainPaper_Normal_MK.icc	
	Quality	Gloss	CW-C4000Series_PlainPaper_Quality_BK.icc	
		Matte	CW-C4000Series_PlainPaper_Quality_MK.icc	
	Matte Paper	Max Speed	Gloss	CW-C4000Series_MattePaper_MaxSpeed_BK.icc
			Matte	CW-C4000Series_MattePaper_MaxSpeed_MK.icc
Speed		Gloss	CW-C4000Series_MattePaper_Speed_BK.icc	
		Matte	CW-C4000Series_MattePaper_Speed_MK.icc	
Normal		Gloss	CW-C4000Series_MattePaper_Normal_BK.icc	
		Matte	CW-C4000Series_MattePaper_Normal_MK.icc	
Quality		Gloss	CW-C4000Series_MattePaper_Quality_BK.icc	
		Matte	CW-C4000Series_MattePaper_Quality_MK.icc	

Media Name	Print Quality	Ink Type	ICC Profile Name
Synthetic	Max Speed	Gloss	CW-C4000Series_Synthetic_MaxSpeed_BK.icc
		Matte	CW-C4000Series_Synthetic_MaxSpeed_MK.icc
	Speed	Gloss	CW-C4000Series_Synthetic_Speed_BK.icc
		Matte	CW-C4000Series_Synthetic_Speed_MK.icc
	Normal	Gloss	CW-C4000Series_Synthetic_Normal_BK.icc
		Matte	CW-C4000Series_Synthetic_Normal_MK.icc
	Quality	Gloss	CW-C4000Series_Synthetic_Quality_BK.icc
		Matte	CW-C4000Series_Synthetic_Quality_MK.icc
Texture Paper	Max Speed	Gloss	CW-C4000Series_TexturePaper_MaxSpeed_BK.icc
		Matte	CW-C4000Series_TexturePaper_MaxSpeed_MK.icc
	Speed	Gloss	CW-C4000Series_TexturePaper_Speed_BK.icc
		Matte	CW-C4000Series_TexturePaper_Speed_MK.icc
	Normal	Gloss	CW-C4000Series_TexturePaper_Normal_BK.icc
		Matte	CW-C4000Series_TexturePaper_Normal_MK.icc
	Quality	Gloss	CW-C4000Series_TexturePaper_Quality_BK.icc
		Matte	CW-C4000Series_TexturePaper_Quality_MK.icc
Wristband	Max Speed	Gloss	CW-C4000Series_Wristband_MaxSpeed_BK.icc
		Matte	CW-C4000Series_Wristband_MaxSpeed_MK.icc
	Speed	Gloss	CW-C4000Series_Wristband_Speed_BK.icc
		Matte	CW-C4000Series_Wristband_Speed_MK.icc
	Normal	Gloss	CW-C4000Series_Wristband_Normal_BK.icc
		Matte	CW-C4000Series_Wristband_Normal_MK.icc
Glossy Paper	Normal	Gloss	CW-C4000Series_GlossyPaper_Normal_BK.icc
		Matte	CW-C4000Series_GlossyPaper_Normal_MK.icc
	Quality	Gloss	CW-C4000Series_GlossyPaper_Quality_BK.icc
		Matte	CW-C4000Series_GlossyPaper_Quality_MK.icc
	Max Quality	Gloss	CW-C4000Series_GlossyPaper_MaxQuality_BK.icc
		Matte	CW-C4000Series_GlossyPaper_MaxQuality_MK.icc

Media Name	Print Quality	Ink Type	ICC Profile Name
Glossy Film	Normal	Gloss	CW-C4000Series_GlossyFilm_Normal_BK.icc
		Matte	CW-C4000Series_GlossyFilm_Normal_MK.icc
	Quality	Gloss	CW-C4000Series_GlossyFilm_Quality_BK.icc
		Matte	CW-C4000Series_GlossyFilm_Quality_MK.icc
	Max Quality	Gloss	CW-C4000Series_GlossyFilm_MaxQuality_BK.icc
		Matte	CW-C4000Series_GlossyFilm_MaxQuality_MK.icc
High Glossy Paper	Normal	Gloss	CW-C4000Series_HighGlossyPaper_Normal_BK.icc
		Matte	CW-C4000Series_HighGlossyPaper_Normal_MK.icc
	Quality	Gloss	CW-C4000Series_HighGlossyPaper_Quality_BK.icc
		Matte	CW-C4000Series_HighGlossyPaper_Quality_MK.icc
	Max Quality	Gloss	CW-C4000Series_HighGlossyPaper_MaxQuality_BK.icc
		Matte	CW-C4000Series_HighGlossyPaper_MaxQuality_MK.icc



ICC profiles made by X-rite solutions are included.

## Procedure for Creating an ICC Profile

When using paper other than Epson genuine paper, acquire an ICC profile of the paper provided by the paper manufacturer, or create an ICC profile for the paper by yourself.

To create an ICC profile, you need a colorimeter and a software program that generates an ICC profile.

Example:

- ❑ X-Rite, Incorporated (<https://xritephoto.com/>)  
i1iO2 (colorimeter), i1Profiler (software program to generate an ICC profile)
- ❑ Datacolor company (<https://www.datacolor.com/>)  
SpyderPrint (print calibration tool)

Since detailed procedure varies depending on the device and software used, the following describes the general procedure. See the manual that came with the device and software for more details.

- 1 Start a software program that generates an ICC profile, and then print color patches for measurement on the paper you want to use.**
- 2 Measure the printed color patches with a colorimeter.**
- 3 Using the software program, generate an ICC profile according to the measured results.**

### No composite

The [Color Correction] button is disabled when [Color Correction Mode] is set to [No composite].

Select [No composite] only when setting color correction on an application software. For instructions on how to set color correction on the software, see its manual or help.

## Processing Paper to Avoid Unprinted Labels

In the case of die-cut label paper or continuous paper (with black marks), the printer may feed the paper without printing on the first label, or may run out of paper despite the existence of unprinted labels. To avoid producing such unprinted labels, this section describes how to process the paper and make settings.

### Printing from the 1st Label

In order to detect the beginning of a page, the printer feeds paper by a certain amount after the paper is loaded. As a result, the printer may not be able to print on the first label. This section explains how to load and process the paper for printing from the first label.

### Loading Paper

When loading paper, check that the leading edge of the paper is in between the auto-cut position and the edge of the paper ejection table, and then close the roll paper cover.

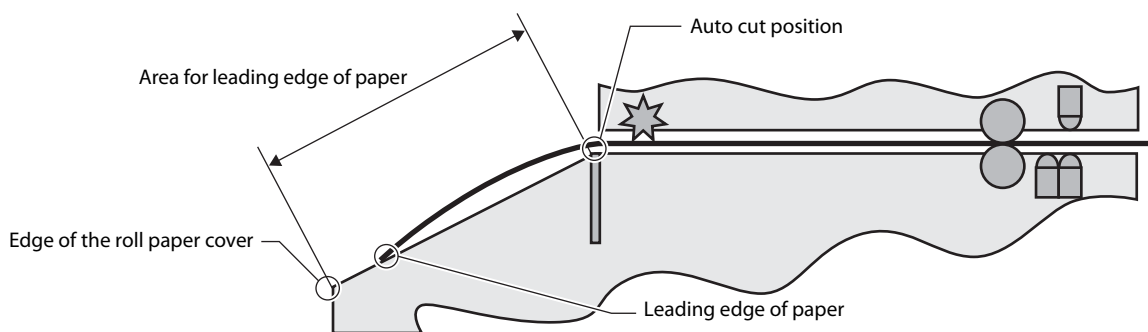

### Roll Paper

The following types/forms of paper can be used.

- Continuous paper (Black Mark)
- Die-cut label (Black Mark)
- Die-cut label (Gap)

### How to process paper

- Continuous paper (Black Mark)

Place the first black mark 190 to 200 mm away from the leading edge of the paper.

Do not place the black mark less than 190 mm from the leading edge of paper.

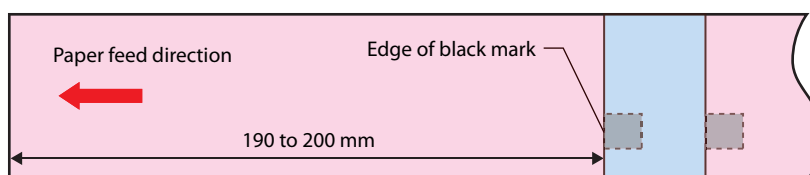

- Die-cut label (Black Mark), Die-cut label (Gap)  
Place the first label 190 to 200 mm away from the leading edge of the paper.  
Less than 190 mm from the leading edge of the paper should be liner paper only, with no labels or black marks.

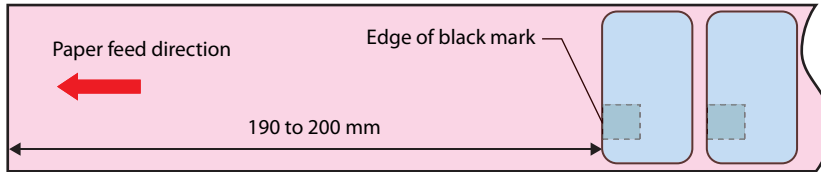

## Fanfold Paper

The following types/forms of paper can be used.

- Continuous paper (Black Mark)
- Die-cut label (Black Mark)

### How to process paper

- Continuous paper (Black Mark)  
Place the first black mark at least 65 mm away from the leading edge of the paper.  
Do not place the black mark less than 65 mm from the leading edge of paper.

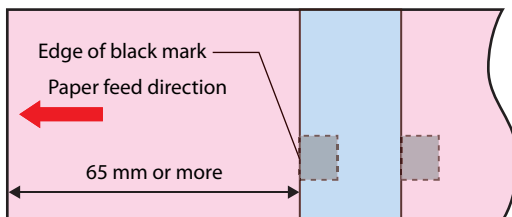

- Die-cut (Black Mark)  
Place the first label at least 65 mm away from the leading edge of the paper.  
Less than 65 mm from the leading edge of the paper should be liner paper only, with no labels or black marks.

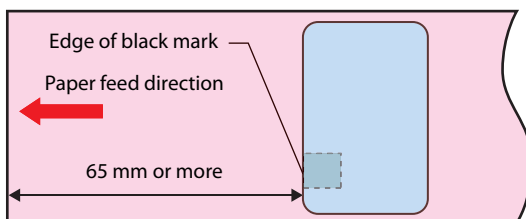

## Printing on the Last Label

There may still be printable labels left when no paper is detected. In order to print on the last label, this section explains how to process the paper.

### How to Process Roll Paper

The following types/forms of paper can be used.

- Continuous paper (Black Mark)
- Die-cut label (Black Mark)
- Die-cut label (Gap)

### How to process paper

- Continuous paper (Black Mark), Die-cut label (Black Mark)

Leave a margin of at least 146 mm between the rear edge of the paper and the rear edge of the last ticket or label. Less than 146 mm from the rear edge of the paper should be liner paper only, with no labels.



When the last ticket or label has been printed, the message "Roll paper is not loaded" will be displayed and the printer will stop. Reload the paper to resume printing.

Continuous paper (Black Mark)

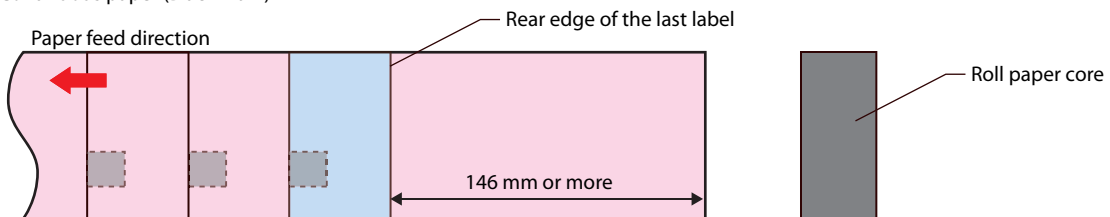

Die-cut label (Black Mark)

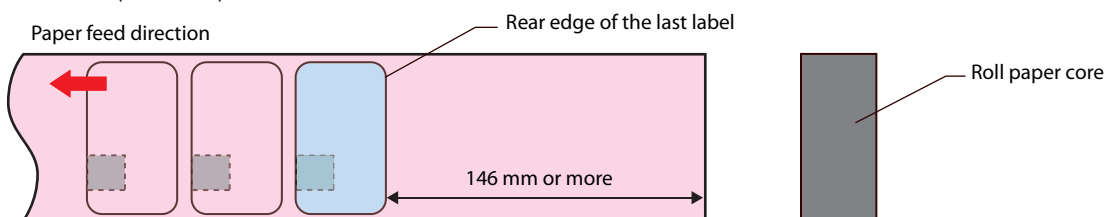



- Die-cut label (Gap)  
 Leave a margin of at least 146 mm between the rear edge of the paper and the rear edge of the last ticket or label. Less than 146 mm from the rear edge of the paper should be liner paper only, with no labels.



When the last ticket or label has been printed, the message shown below will be displayed and the printer will stop. Reload the paper to resume printing.

<Message>  
 Cannot detect the paper with the specified [Media Detect] setting.  
 Load paper that matches the setting or change the [Media Detect] setting.

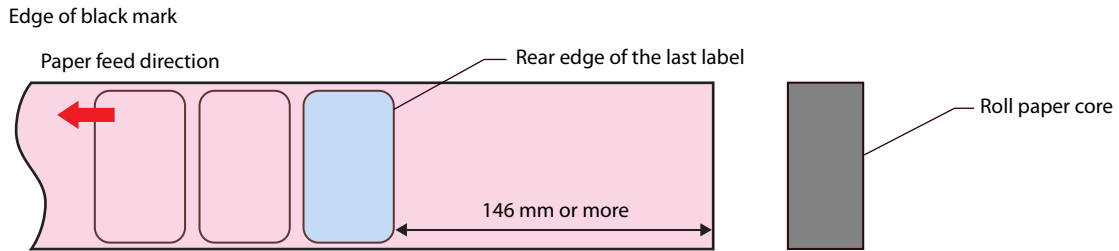

### How to Process Fanfold Paper

The following types/forms of paper can be used.

- Continuous paper (Black Mark)
- Die-cut label (Black Mark)

### How to process paper

Leave a margin of at least 198 mm between the rear edge of the paper and the rear edge of the last ticket or label. Less than 198 mm from the rear edge of the paper should be liner paper only, with no labels.



When the last ticket or label has been printed, the message "Fanfold paper is not loaded" will be displayed and the printer will stop. Reload the paper to resume printing.

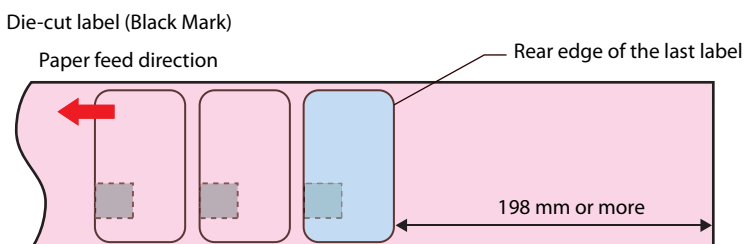
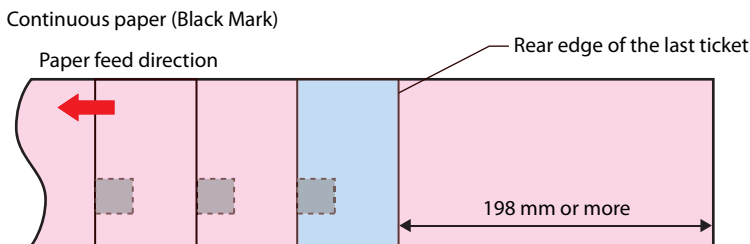

## ***Adjusting Sensitivity of the Detectors and Threshold for Detecting Labels***

The printer is equipped with two detectors; one detects leading edge of each label and another one detects black marks.

If you have labels that cannot be detected by the printer, the labels may become detectable by changing sensitivity of the detectors and/or threshold for detecting labels.

Change the settings using the operation panel.

[Menu] - [Maintenance] - [Calibration]

### **Simple Media Detect**

Allows you to adjust the threshold for detecting labels. Since this adjustment can be made in a short time, perform this adjustment first.

### **Media Detect**

Allows you to adjust the sensitivity of the detectors and the threshold for detecting labels. Perform this adjustment if your labels still cannot be detected after performing the [Simple Media Detect] adjustment.

## ***Detecting Differences in Paper Size Using Label Command***

This function is for the users who use label commands to print labels. Label commands include a command that detects differences in paper size. Use the function to detect paper size differences before printing starts.

## Restricting Operation of the Operation Panel (Lock Setting function)

The [Lock Setting] function allows an administrator to lock the paper settings, printer settings, and/or system administration related settings to prevent unauthorized changes.

The procedure is as follows

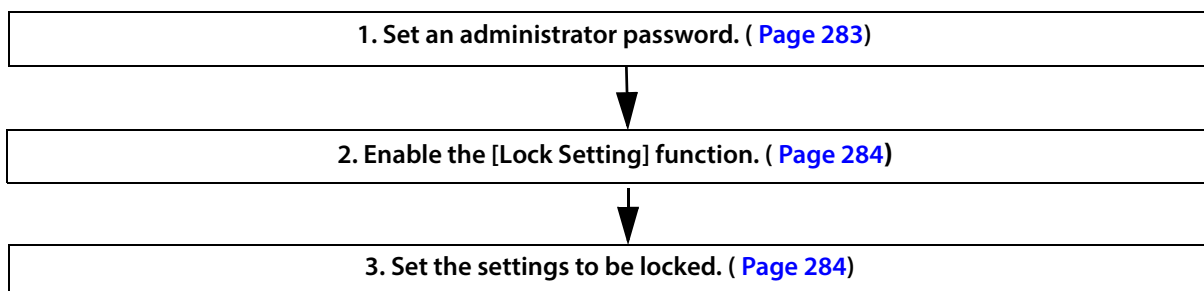

The following settings can be locked.

**General Settings:** Settings that are rarely changed once you configure them, such as the network settings and datetime settings.

**Media Settings:** Settings related to media (paper)

**Printer Settings:** Menus for adjusting or maintaining the printer and the print settings

To know which menu or setting can be locked, see "[Operation Panel Settings](#)" on page 230.

### Checking the Initial Value for the Administrator Password

The initial value for the administrator password depends on whether there is a password label applied to the rear of the printer.

- If there is a password label  
The "PASSWORD" on the password label is the initial value.

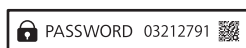

In the example shown, the initial password is 03212791.

- If there is no password label  
The serial number of the printer is the initial value.  
You can check the serial number on the status sheet. ("[Printing Status Sheet](#)" on page 34)

## Enabling the [Lock Setting] Function

Set an administrator password in advance.

- 1** Select [Menu] - [General Settings] - [System Administration] - [Security Settings] - [Admin Settings] in that order.
- 2** Set [Lock Setting] to [On].  
Options that allow you to set which settings to lock are displayed.
- 3** Select the target options you want to lock, set it to [On], and then press the OK button.



When you set "Lock Setting" to "On", the "General Settings" option is automatically set to "On". You cannot set the "General Settings" option to "Off" with "Lock Setting" set to "On".

- 4** When a confirmation message is displayed, select [Yes].

Once the Lock Setting is enabled, the administrator password is required when changing any one of the locked settings.

## Changing the Administrator Password

- 1** Select [Menu] - [General Settings] - [System Administration] in that order.
- 2** Enter the current administrator password, and then select [OK] on the screen.
- 3** Select [Security Settings] - [Admin Settings] - [Admin Password] - [Change] in that order.
- 4** Enter the current administrator password, and then select [OK] on the screen.
- 5** Enter a new administrator password, and then select [OK] on the screen.





Set the new password using alphanumeric characters and symbols, with a length of eight or more characters but no more than 20 characters.

- 6** Enter the new password again, and then select [OK] on the screen.
- 7** When a message is displayed, press the OK button.

## Resetting the Administrator Password

If you forgot the password, reset the password following the procedure below.

- 1** Press the  (Home) button to display the home screen.
- 2** Hold down the  (back) button and  (cancel) button at the same time.
- 3** When a confirmation message is displayed, select [Yes].
- 4** Enter the password to unlock, and then select [OK] on the screen.

The password to unlock depends on whether there is a password label applied to the rear of the printer.

- If there is a password label  
Enter the value for "PASSWORD" on the password label.



In the example shown, the initial password is 03212791.

- If there is no password label  
Enter "1234".



Even if there is a password label on the rear of the printer, it might not be possible to initialize the printer depending on the firmware version. In that case, enter "1234".

- 5** When a message is displayed, press the OK button.

## Cleaning the Printer

This chapter describes how to carry out maintenance of the printer.

### Cleaning the Exterior

Disconnect the power cable from the power outlet and wipe off any dirt with a dry or slightly damp cloth.



Do not use alcohol\*, benzene, thinner, trichloroethylene, or ketone based solvent to clean the exterior of the printer. Doing so may deform or damage the plastic and rubber parts.

\* When using alcohol, refer to "[Cleaning the Exterior with Alcohol for Disinfection](#)".

### Cleaning the Exterior with Alcohol for Disinfection

Use the following cleaning method that we have verified.

Prepare the following items for cleaning.

- Rubbing alcohol
- Soft cloth (for disinfecting with alcohol and for wiping)
- Vinyl gloves



- For rubbing alcohol, use ethanol with a concentration of 70 to 80 vol% or isopropyl alcohol with a concentration of about 70 vol%. Other chemicals have not been tested by us and using them may cause deterioration, discoloration, or cracking of the printer.
- For soft cloths, use uncolored microfiber cloths. Other types of cloths have not been tested by us and may scratch the surface of the printer if used.
- Do not use rubbing alcohol for cleaning the following parts. Use a soft, dry cloth.
  - Connectors (Power connector, LAN port, USB port)  
Use of rubbing alcohol may cause poor contact of the connectors.
  - Labels attached to the printer  
Use of rubbing alcohol may cause the printed contents of the label to disappear.
  - Operation panel, Transparent window of the front cover  
Use of rubbing alcohol may cause the operation panel and window to fog up, making it difficult to see the panel and the inside of the printer.
  - AC adapter  
Use of rubbing alcohol may cause short-circuiting, deterioration, or damage to the electronic components, which may result in electric shock or fire.

Follow the steps below to clean the exterior.

- 1 Turn off the printer, and unplug the power cable.**
- 2 Wipe gently and slowly with a soft cloth lightly moistened with rubbing alcohol.**  
After cleaning, wipe with a soft, dry cloth so that no rubbing alcohol remains on the surface.

**CAUTION**

- Cleaning work should be performed under normal temperature environment. Under high temperature environment, rubbing alcohol may cause deterioration, discoloration, and cracking of the printer surface.
- Do not spray rubbing alcohol directly on the printer or clean it with a cloth so damp that it drips rubbing alcohol. Also, do not allow rubbing alcohol to enter inside the printer through gaps in the buttons on the control panel and gaps in covers. If rubbing alcohol gets inside the printer, it may short-circuit the electronic components or cause deterioration or damage to the components.
- Do not rub the printer surface strongly or wipe the same area repeatedly. The printer surface may become deteriorated or damaged beyond repair.
- Clean with rubbing alcohol no more than three times a day.
- Do not connect the power plug or operate the power supply until the rubbing alcohol has completely dried.

## Cleaning the Platen

If there is ink adhered to the platen, hands or paper may become dirty. Furthermore, if the holes in the platen become blocked by dirt, ink soiling inside the platen may occur.

Use the non-woven fabric or cotton swabs to clean the platen by following the steps below.

**CAUTION**

- Do not use water or alcohol.
- Take care not to change the position of the shutters on the platen. If the shutters are opened or closed incorrectly, paper may get jammed or be smudged with ink.
- Take care not to deform or damage the four sensors.

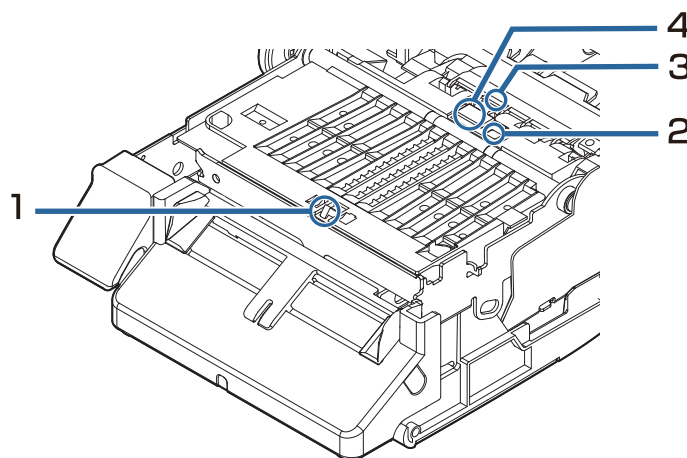

**1** Turn the printer off and then disconnect the power cable from the outlet.

**2** Open the front cover.

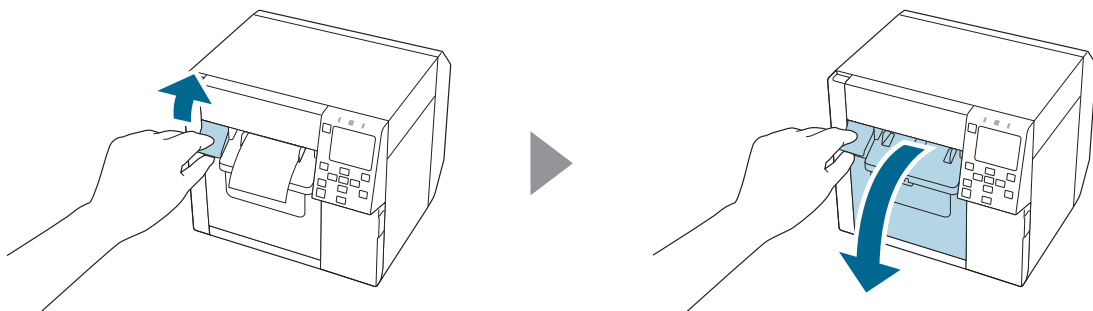

- 3** Remove the roll paper or fanfold paper.
- 4** Use the non-woven fabric for platen cleaning to clean the platen.

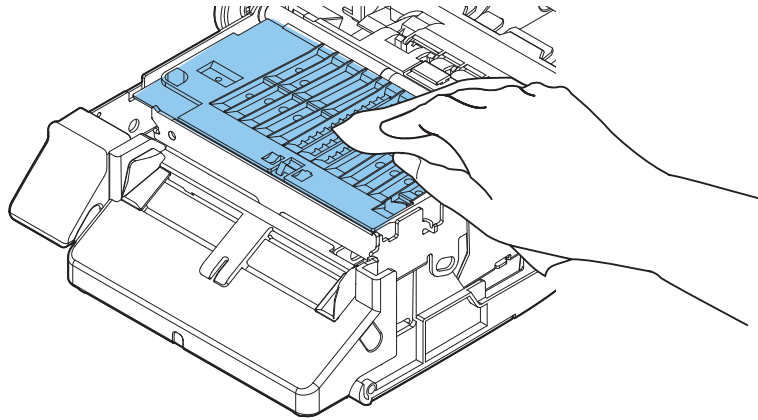

- 5** Use cotton swabs to clean the holes and around the holes. If the holes are blocked, be sure to remove the dirt to unblock the holes.

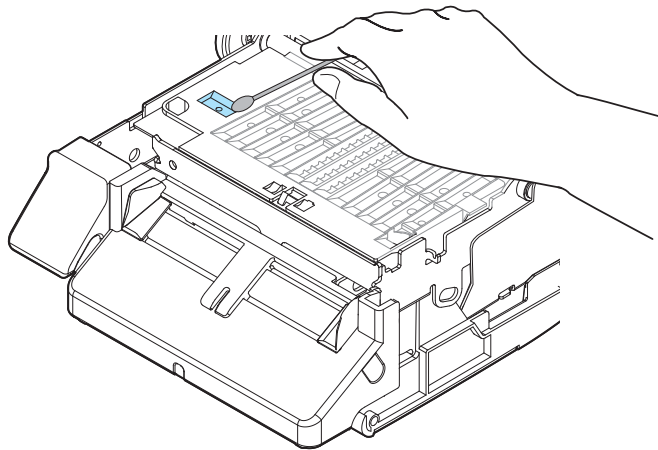

- 6** Close the front cover.



## Cleaning the Auto Cutter

The fixed blade of the auto cutter may become unable to cut cleanly due to the adhesive of label paper adhering to it.

Perform cleaning by following the steps below.

- 1** Turn the printer off and then disconnect the power cable from the outlet.
- 2** Open the front cover and remove the paper.
- 3** Remove the adhesive adhered to the fixed blade of the auto cutter on the front cover side.

Remove it with a cotton swab or the like dampened with alcohol.

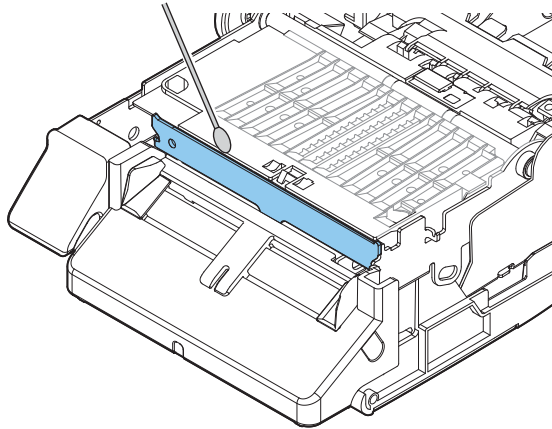

- Do not directly touch the fixed blade of the auto cutter. Doing so may cause injury to a finger.
- Do not use benzine, thinner, trichloroethylene, or ketone based solvent. Doing so may deform or damage the plastic and rubber parts.
- Do not spray or allow alcohol to drip directly on the printer. If alcohol gets inside the printer, it may short-circuit the electronic components or cause deterioration or damage to the components.
- Be careful not to allow alcohol to come into contact with any sections beside the areas to be cleaned.

## Cleaning the Inside of the Printer (when Paper is fed from the Inside)

When printing on label paper feeding it from the roll paper set inside the printer, the adhesive of the label paper may adhere to the inside of the printer, resulting in poor print quality.

Please follow the procedure below to clean the printer.

- 1 Turn off the printer and disconnect the power cable from the power outlet.**
- 2 Open the front cover and remove the paper.**
- 3 Remove any adhesive from the roller.**  
Use a cloth moistened with alcohol (recommended: ethanol 80 vol% or less). While rotating the roller by hand, remove the adhesive and clean the entire roller.

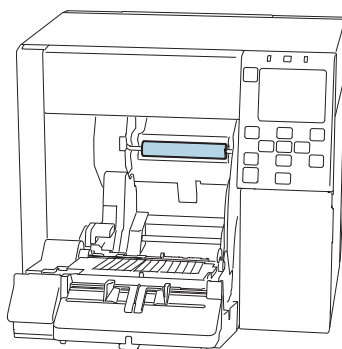

- 4 Remove any adhesive that has adhered to the inner surface of the paper guides.**  
Use a cloth moistened with alcohol (recommended: ethanol 80 vol% or less).

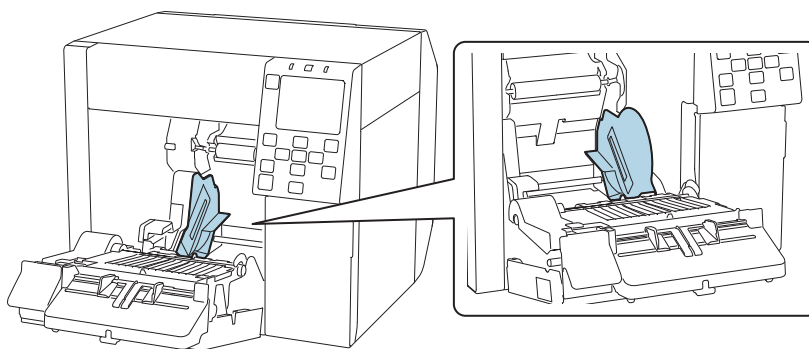

- Do not use benzine, thinner, trichloroethylene, or ketone based solvent. Doing so may deform or damage the plastic and rubber parts.
- Do not spray or allow alcohol to drip directly on the printer. If alcohol gets inside the printer, it may short-circuit the electronic components or cause deterioration or damage to the components.
- Be careful not to allow alcohol to come into contact with any sections beside the areas to be cleaned.

## Cleaning the Inside of the Printer (when Paper is fed from the Outside)

When printing on label paper feeding it from outside the printer, the adhesive of the label paper may adhere to the inside of the printer, resulting in poor print quality.

Please follow the procedure below to clean the printer.

- 1** Turn off the printer and disconnect the power cable from the power outlet.
- 2** Open the front cover.
- 3** Open the rear cover and remove the paper.
- 4** Remove any adhesive that has adhered to the inner surface of the fanfold paper guides.

Use a cloth moistened with alcohol (recommended: ethanol 80 vol% or less).

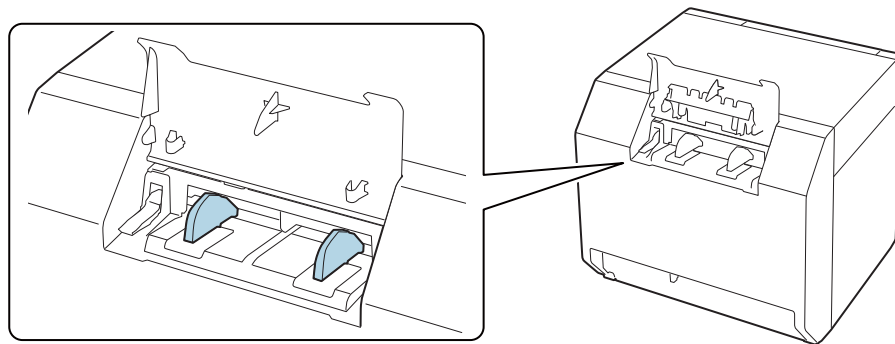

- 5** Remove any adhesive that has adhered to the inner surface of the paper feed guide.

Use a cloth moistened with alcohol (recommended: ethanol 80 vol% or less).

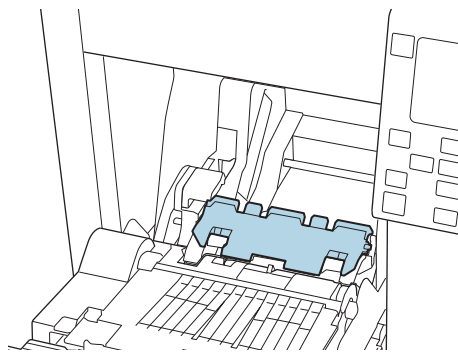

- Do not press down hard on the paper feed guide. This may cause the paper feed guide to come off or be damaged.
- Do not use benzine, thinner, trichloroethylene, or ketone based solvent. Doing so may deform or damage the plastic and rubber parts.
- Do not spray or allow alcohol to drip directly on the printer. If alcohol gets inside the printer, it may short-circuit the electronic components or cause deterioration or damage to the components.
- Be careful not to allow alcohol to come into contact with any sections beside the areas to be cleaned.

## Cleaning the Print Head

If the nozzles are clogged, faint colors, banding, or unintended colors appear on printouts.

When such print quality problems occur, print nozzle check patterns and check for nozzle clogging.



### IMPORTANT

When printing the nozzle check pattern, load paper that is at least 21.4 mm (0.84 inches) wide and 38.6 mm (1.52 inches) long.

## Amount of Remaining Paper Required to Print a Nozzle Check Pattern

### Continuous paper / continuous label

If the paper width is 21.4 mm (0.84 inches) to 39.0 mm (1.54 inches): 273.5 mm (10.77 inches)

If the paper width is 39.1 mm (1.54 inches) or more: 197.4 mm (7.77 inches)



Printing a nozzle check pattern with black mark detection still enabled may increase the amount of remaining paper required. We recommend using settings where black marks are not detected, even for paper with black marks, when printing.

### Die-cut label (included roll paper)

For the included roll paper, the nozzle check pattern can be printed with two labels.

Included roll paper: paper width 108.0 mm (4.25 inches), paper length 174.8 mm (6.88 inches), gap between pages 3.0 mm (0.12 inches)



When printing the nozzle check pattern with die-cut labels, the amount of remaining paper required depends on the paper width, paper length, and gap between pages. Since some combinations require paper lengths of up to 531 mm (20.9 inches), we recommend using continuous paper, continuous labels, or the included roll paper.

Example of the nozzle check patterns with gloss black ink

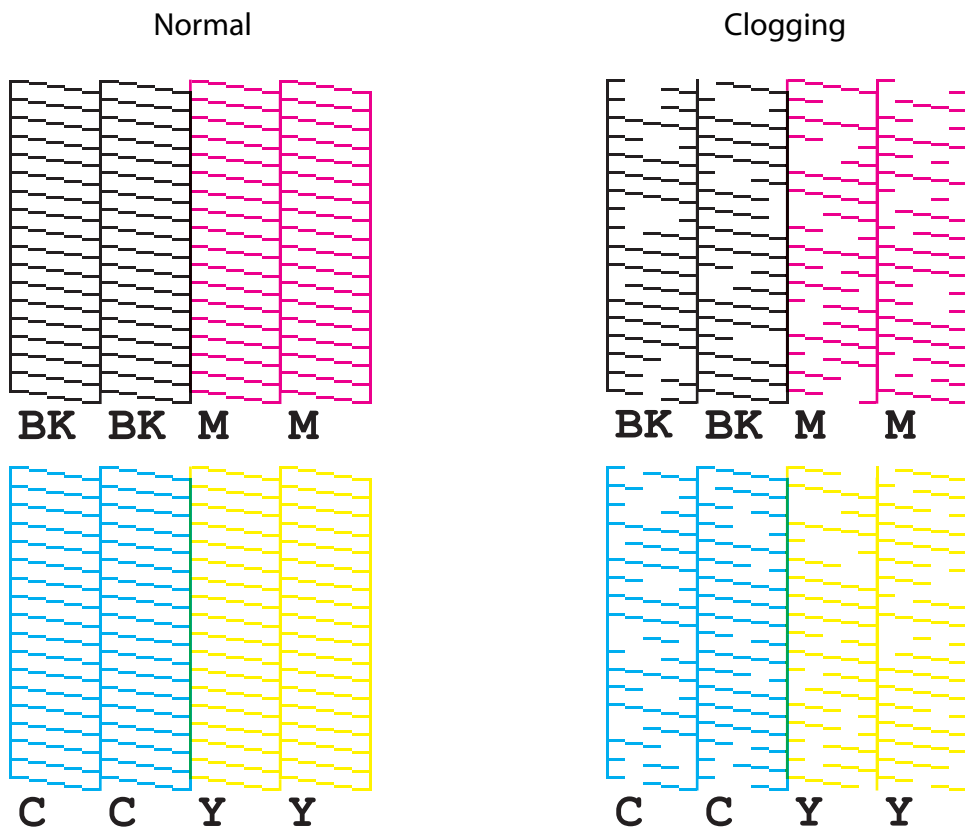

When the printed patterns show the nozzle clogging state, run a head cleaning.

## Printing Nozzle Check Patterns

You can print the nozzle check patterns using the nozzle check function available from the operation panel or the printer driver.

### Using the Operation Panel

[Menu] - [Maintenance] - [Print Head Nozzle Check]

### Using the Printer Driver

Click [Nozzle Check] on the [Printer Utilities] tab.

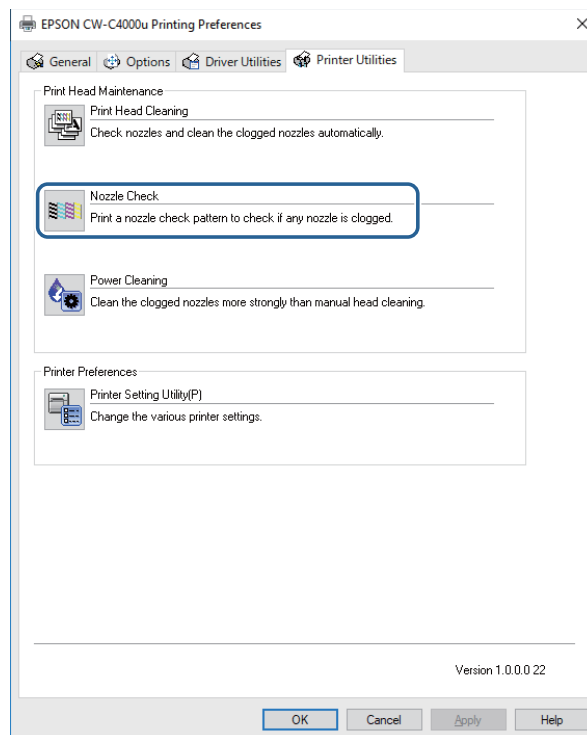

## Print Head Cleaning

If nozzles are clogged, run a print head cleaning. Run [Power Cleaning] only when nozzle clog is not cleared by running [Print Head Cleaning].

To run a print head cleaning, select the menu as described below.



### IMPORTANT

- Do not turn off the power or open the covers during head cleaning. Doing so may cause printing malfunction.
- Do not run the head cleaning more than necessary. Ink is consumed because ink is discharged from the head to clean it.
- If there is not much ink remaining, head cleaning may not be possible. Replace the ink cartridges and then try again. ("[Replacing the Ink Cartridges \(p45\)](#)")
- The [Power Cleaning] consumes ink more than [Print Head Cleaning].

## Using the Operation Panel

[Menu] - [Maintenance] - [Print Head Cleaning]

[Menu] - [Maintenance] - [Power Cleaning]

## Using the Printer Driver

Click [Print Head Cleaning] or [Power Cleaning] on the [Printer Utilities] window.

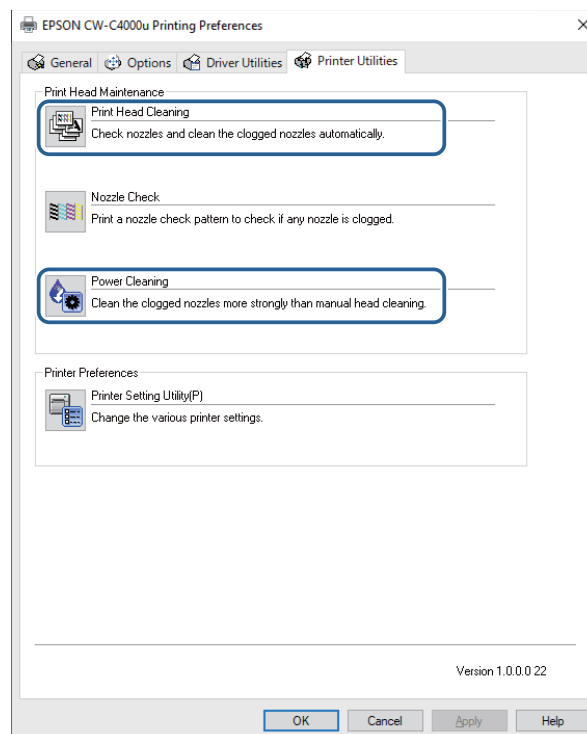

## Using the WebConfig

Select [Print Head Cleaning] on the [Maintenance] window. Then select the cleaning type from [Auto] or [Power Cleaning], and then click [Start].

For details on WebConfig, see "[WebConfig](#)" on page 242.



## Storing the Printer After Ink is Charged

### Storing the Printer for Long Periods



If you need to store the printer for long periods after installing the ink cartridges, follow the procedure below.

- 1 **Run the nozzle check to confirm that the print head nozzles are not clogging and there is no problem with the print quality. If the print quality is not good, run a print head cleaning.**

See "[Test Print](#)" on page 82.



 <b>CAUTION</b>	<p>If you store the printer without solving the print quality problem (nozzle clogging), ink inside the nozzles may get hard and the print quality problem may become unrecoverable when you start using the printer again.</p>
	<p>If you have transported the printer after installing the ink cartridges, nozzle clogging may occur due to vibrations applied to the printer during the transport.</p>

- 2 **When printing is finished, press the  (Power) button to turn off the printer.**

 <b>CAUTION</b>	<p>Especially when storing the printer for long periods, make sure to turn it off using the  (Power) button.</p>
---	---

- 3 **Store the printer in a cool and dark place.**

For information about environmental requirements for storing the printer, see "[Environmental Specifications](#)" on page 359.

 <b>CAUTION</b>	<p>The printer has a storage life of up to six months.</p>
	<p>Make sure to store the printer with all ink cartridges installed.</p>



## Transporting or Storing the Printer at -10°C (With Matte Black Ink Installed)

If the ambient temperature becomes -10°C or lower, the print head may be damaged. If -10°C or lower ambient temperature is expected, discharge ink in advance following the procedure below.



- Since ink is discharged to the maintenance box, the box needs to have enough remaining space for the discharged ink. If the remaining space in the box is not enough, have a new maintenance box ready for replacement.
- During the ink discharging work, keep the ambient temperature between 5 to 35 degrees C.
- While the printer is discharging ink, do not open any cover or turn off the printer.

- 1 If paper has been loaded, remove it.**
- 2 Select the menus on the operation panel in the order shown below.**  
[Menu] - [Maintenance] - [Ink Discharging]
- 3 When a confirmation message is displayed, select [Start].**  
Ink discharging is started. When discharging ink is finished, the printer is automatically turned off.



When you use the printer next time, you need to recharge ink to the printer. When the printer is turned on, a confirmation screen for recharging ink appears. Select [OK] to start recharging ink. It takes about 5 to 14 minutes. When recharging ink is finished, a home screen appears.

## For Using the Printer after Long Storage

When using the printer after storing it for long periods, follow the procedure below.

- 1 Check the ink cartridges to see if they are expired.**



Replace the ink cartridges with new ones in the following cases.  
For instructions on how to replace the cartridges, see "[Installing the Ink Cartridges](#)" on page 44.

- Three years or more have passed from the manufacturing date.
- Six months or more have passed from when the cartridge was installed in the printer.

- 2 Turn the printer on.**  
The auto self-check function checks the nozzles for clogging and run a cleaning.



**CAUTION**

While the printer is running the print head cleaning, do not turn off the power or open the ink cartridge cover, front cover, paper cover, and the maintenance box cover.

- 3 Run the nozzle check to confirm that the print head nozzles are not clogging and there is no problem with the print quality.**

## For Transporting the Printer

When transporting the printer, make sure to follow the guidelines below.



- Make sure to remove paper before transporting the printer.
- Do not remove the ink cartridges and the maintenance box for transporting the printer.
- When turning off the printer for transporting, make sure to turn off the printer with the  (Power) button.
- Do not let the printer tilt to all directions by 10 degrees or more during transportation. Otherwise, the printer may fall down causing an accident.
- Do not let the printer upside down or lay on its side during transportation.

# Troubleshooting

## A message is displayed on the operation panel.

Message	Solution
Information Paper feed error. Load the paper or change the media source setting.	Use paper that matches the [Media Source] and [Media Form] settings. Or change the [Media Source] and [Media Form] settings to match them with the loaded paper. ( <a href="#">"Paper Source and Paper Detection Settings" on page 91</a> )
Information Cannot detect the paper with the specified [Media Detect] setting. Load paper that matches the setting or change the [Media Detect] setting.	Use paper that matches the [Media Detect] settings. Or change the [Media Detect] settings to match them with the loaded paper. ( <a href="#">"Paper Source and Paper Detection Settings" on page 91</a> )
(On the home screen) Load paper.	Load paper. ( <a href="#">"Loading Paper" on page 66</a> )
Information The paper size set in the printer may differ from the print setting.	Load media that matches the print area size. Or change the print area to match it with the media size. ( <a href="#">"Loading Paper" on page 66</a> )
Paper Out The roll paper is not loaded.	Load roll paper. ( <a href="#">"Loading Paper" on page 66</a> )
Paper Out The fanfold paper is not loaded.	Load fanfold paper. ( <a href="#">"Loading Paper" on page 66</a> )
Information Paper jam.	Remove the jammed paper and then load paper. ( <a href="#">"Paper Jam" on page 315</a> )
Information The paper has not been loaded correctly. Reload the paper.	Remove the paper, and then load the paper again. ( <a href="#">"How to Remove Paper" on page 80</a> , <a href="#">"Loading Paper" on page 66</a> )
Information Calibration failed. Press the OK button. Then reload or replace the paper.	Make sure that the paper loaded in the printer matches the paper detection method (gap or black mark), and reset the paper. ( <a href="#">"How to Remove Paper" on page 80</a> ) Calibration is impossible if gap between labels exceeds 6 mm. ( <a href="#">"Paper Specifications" on page 344</a> ) If the error still occurs, the detector cannot handle the paper. Replace the paper.
Information The paper has already been cut and cannot be cut.	This error occurs when you press the Cut button at the position where the paper is already cut. Feed the paper by printing or pressing the Feed button to enable the Cut button.
Maintenance Error The ink cartridge is not installed correctly.	Install an ink cartridge with a sufficient amount of ink remaining. ( <a href="#">"Replacing the Ink Cartridges" on page 45</a> )

Message	Solution
(On the home screen, an exclamation mark on the ink levels)	<p>Prepare a new ink cartridge to be replaced with the low-ink-level cartridge.</p> <p>If you continue to use the low-ink-level cartridge, you may be required to replace it during printing.</p> <p>If you replace the cartridge during printing, you may see a difference in color between colors printed by the old cartridge and colors printed by the new one due to a difference in ink drying status.</p> <p>If it is not acceptable for you, replace the ink cartridge with a new one before starting printing.</p> <p><a href="#">("Replacing the Ink Cartridges" on page 45)</a></p> <p>The removed ink cartridge can be installed again and used until you are prompted to replace it.</p>
<p>Information</p> <p>You need to replace Ink Cartridge(s).</p>	<p>Install an ink cartridge with a sufficient amount of ink remaining.</p> <p><a href="#">("Replacing the Ink Cartridges" on page 45)</a></p>
<p>Maintenance Error</p> <p>Cannot recognize the ink cartridge.</p> <p>Select "Next" to clear the error.</p>	<p>Reinstall the ink cartridge.</p> <p>If the error reoccurs, replace the ink cartridge with a new one.</p> <p><a href="#">("Replacing the Ink Cartridges" on page 45)</a></p>
<p>Information</p> <p>You have not installed genuine Epson ink cartridges.</p>	<p>For the best performance of the printer, it is recommended to use genuine Epson ink cartridges.</p> <p>Use of non-genuine Epson ink cartridges can adversely affect the printer and print quality and prevent the printer from realizing its maximum performance.</p> <p>Epson cannot guarantee the quality and reliability of non-genuine Epson products.</p> <p>Repairs for any damage or breakdown of this product due to the use of non-genuine Epson products will not be free of charge even if the warranty period is still valid.</p>
<p>Information</p> <p>These ink cartridges are not compatible.</p>	<p>Because the installed ink cartridges are not the ones for this printer, an error such as a cartridge detection error may occur.</p>
<p>Maintenance Error</p> <p>A maintenance box is not installed.</p> <p>Model number: SJMB4000</p>	<p>Install a new maintenance box.</p> <p><a href="#">("Replacing the Maintenance Box" on page 48)</a></p>
<p>Maintenance Error</p> <p>Cannot recognize the maintenance box.</p> <p>Model number: SJMB4000</p>	<p>Reinstall the maintenance box.</p> <p>If the error reoccurs, replace the maintenance box with a new one.</p> <p><a href="#">("Replacing the Maintenance Box" on page 48)</a></p>
<p>(On the home screen)</p> <p>The Maintenance Box is nearing end of its service life.</p>	<p>Prepare a new maintenance box to be replaced with the near-full maintenance box.</p> <p>When a message saying "The Maintenance Box is at the end of its service life. You need to replace it." is displayed, replace the maintenance box.</p> <p><a href="#">("Replacing the Maintenance Box" on page 48)</a></p>

Message	Solution
<p>Maintenance Error</p> <p>The Maintenance Box is at the end of its service life.</p> <p>You need to replace it.</p> <p>Model number: SJMB4000</p>	<p>Replace the maintenance box with a new one.</p> <p>(<a href="#">"Replacing the Maintenance Box" on page 48</a>)</p>
<p>Information</p> <p>Memory Full. Document was not printed.</p>	<p>Contact your system administrator and delete unnecessary files.</p>
<p>Printer Error</p> <p>Turn on the printer again.</p> <p>See your documentation for more details.</p> <p>XXXXXX</p>	<ol style="list-style-type: none"> <li>1. Turn off the printer.</li> <li>2. Check that there is no paper jam or foreign materials near the ejection slot.</li> <li>3. Turn the printer on.</li> </ol> <p>If the printer error still occurs, contact qualified service personnel for advice. When contacting, tell the person the "XXXXXXXX" (a 6- or 8-digit alphanumeric code).</p>
<p>Information</p> <p>Cannot start cleaning because ink is low.</p> <p>Printer features except cleaning are available.</p>	<p>When running the cleaning, install ink cartridges with a sufficient amount of ink remaining.</p> <p>(<a href="#">"Replacing the Ink Cartridges" on page 45</a>)</p>
<p>Information</p> <p>Paused</p> <p>The print quality may decrease because the nozzles are clogged.</p>	<p>The print quality may decrease because the nozzles are clogged. If it is not acceptable, run a print head cleaning.</p> <p>(<a href="#">"Cleaning the Print Head" on page 292</a>)</p>

Message	Solution
<p>Error</p> <p>The connection between your network and the printer is unstable.</p> <p>You may be able to solve this problem by disabling the IEEE802.3az (Energy Efficient Ethernet) function.</p> <p>See your documentation for more details.</p>	<p>When connecting to a wired LAN using a device that supports IEEE802.3az (Energy Efficient Ethernet), the connection may become unstable, the connection may not be possible, or the communication speed may slow down.</p> <p>Follow the steps below to disable the IEEE802.3az function on your computer and printer.</p> <ol style="list-style-type: none"> <li>1. Disconnect the LAN cables from the computer and printer respectively.</li> <li>2. If the IEEE802.3az function has been enabled on your computer, disable it.</li> <li>3. Connect the computer and printer directly with a LAN cable.</li> <li>4. On the printer, select [Menu] - [General Settings] - [Network Settings] - [Connection Check] to check the IP address of the printer.</li> <li>5. Start WebConfig on the computer.</li> </ol> <p>Start your web browser and enter the IP address of the printer.</p> <ol style="list-style-type: none"> <li>6. Select the [Network Settings] tab, then [Ethernet].</li> <li>7. Set [IEEE 802.3az] to [Off].</li> <li>8. Click [Next].</li> <li>9. Click [Apply].</li> <li>10. Disconnect the LAN cable from the computer and printer.</li> <li>11. If you disabled IEEE802.3az on your computer in step 2, enable it.</li> <li>12. Connect the LAN cables you disconnected in step 1 to the computer and printer.</li> </ol> <p>If the problem still occurs, a device other than the printer may be causing the problem.</p>

## Print Quality Problems

Status	Cause	Solution
Horizontal White Banding	The nozzles are clogging.	Print the nozzle check patterns to check the nozzles for clogging. ("Test Print" on page 82) If the nozzles are clogging, run a print head cleaning. ("Cleaning the Print Head" on page 292)
White or Black Banding	The paper is not loaded correctly.	Reload the paper. ("Loading Paper" on page 66)
	The paper being used and the Media Coating Type setting differ.	Check the paper being used and the Media Coating Type setting of the printer driver. ("Printer Driver for Windows" on page 84)
	White banding or black banding can occur if the paper feeding setting is not appropriate for the paper used.	Adjust the paper feed settings. The adjustment is available in [Print Head Alignment] of PrinterSetting. ("Print Head Alignment" on page 208)
Unintended Top and Bottom Margins are Generated	If die-cut label (without black marks) thinner than required thickness is used, the printer may not be able to correctly detect the labels and cause unintended top and bottom margins on each label. (The "top and bottom" used here means the beginning and end of labels in the paper feed direction.)	Carry out [Print start position adjustment (Vertical direction)] of PrinterSetting. Enter a minus correction value to reduce the top margin, and enter a plus correction value to reduce the bottom margin. ("Position adjustment" on page 195)
Printed Characters Look Blurred	The outside shutters on the platen, which are not needed to be opened for the paper, are open.	Air flow from the outside shutters adversely affect the printing operation and may cause blurred print. Set the shutters on the platen according to the instructions on the label attached to the printer. ("Adjusting the Shutters" on page 78)
	Blurred print may occur when the printer settings are not appropriate for the thickness of the paper.	Carry out [Bi-directional Printing Adjustment] of PrinterSetting. ("Print Head Alignment" on page 208)
Printed Colors Are Wrong	If the printer is moved after initial charging, the specified colors may not be output (colors may be mixed) due to vibrations and impacts.	Run a head cleaning and check that colors are no longer mixed. ("Cleaning the Print Head" on page 292)

Status	Cause	Solution
Print position shifts	The edge guide is not set along the paper edge.	Check that the edge guide is properly set at the paper width position. (" <a href="#">Loading Paper</a> " on page 66)
	The paper is not loaded centrally.	If the paper is offset from the center when loaded, print position may be laterally shifted at the beginning of printing. Use the paper guides to load the paper centrally or feed the paper before starting printing.
	The rear edge of the paper is approaching	When the trailing edge of the paper approaches, print position may be laterally shifted, or blurred print may occur. Replace the paper with a new one.
	Paper that is easily folded or soft might not feed properly because it is easily sucked onto the platen.	Depending on paper used, manual adjustment of the platen vacuum is required. Carry out the manual adjustment using the printer driver following the steps below. <ol style="list-style-type: none"> <li>1. Display the [General] window of the printer driver.</li> <li>2. Click [Advanced] in the [Media Settings] field. The advanced settings window appears. ("<a href="#">Advanced</a>" on page 90)</li> <li>3. Select the check box for [Media Hold Pressure] in the [Paper Adjustment] field. The manual adjustment is enabled.</li> <li>4. Move the slide bar to lower the number and reduce the suction power.</li> </ol>
Paper is Smeared or Smudged with Ink	The paper being used and the Media Coating Type setting differ.	Check the paper being used and the Media Coating Type setting of the printer driver. (" <a href="#">Printer Driver for Windows</a> " on page 84)
	If foreign matter is adhered to the head, the paper may be smeared with ink.	Run a print head cleaning. (" <a href="#">Cleaning the Print Head</a> " on page 292)
	If the platen vacuum is insufficient for the paper, the paper may rub against the print head and be smeared with ink.	Depending on paper used, manual adjustment of the platen vacuum is required. Carry out the manual adjustment using the printer driver following the steps below. <ol style="list-style-type: none"> <li>1. Display the [General] window of the printer driver.</li> <li>2. Click [Advanced] in the [Media Settings] field. The advanced settings window appears. ("<a href="#">Advanced</a>" on page 90)</li> <li>3. Select the check box for [Media Hold Pressure] in the [Paper Adjustment] field. The manual adjustment is enabled.</li> <li>4. Move the slide bar to raise the number and increase the suction power.</li> </ol>
	The paper width and the shutters on the platen do not match.	If the paper width and shutters on the platen do not match, rising up of the paper may cause the paper and print head to rub against each other, leading to the paper becoming dirty. Set the shutters on the platen according to the instructions on the label attached to the printer. (" <a href="#">Adjusting the Shutters</a> " on page 78)



Status	Cause	Solution
Part of print data is rimmed/Auto cut or Peeling position is Incorrect	The paper being used and the media definition (size settings) do not match.	If the paper and the media definition of the printer driver do not match, printing may not be at the correct position. Set the media definition correctly. (" <a href="#">User-Defined Paper</a> " on page 93)
	Shift of print and stop position may occur depending on the paper used.	Adjust the print start position using PrinterSetting. (" <a href="#">Position adjustment</a> " on page 195)

## Cannot Print

Status	Cause	Solution
Auto Paper Feeding does Not Start	The sensor has failed.	If operation was normal up until now, the sensor has probably failed. Request repairs.
Paper is Fed and Ejected, and an Error Occurs  Media Form: Continuous label (without black marks)	The paper being used differs from that of Media detection settings.	Check the paper being used and Media detection settings of the printer. (" <a href="#">Paper Source and Paper Detection Settings</a> " on page 91)
Paper is Fed and Ejected, and an Error Occurs  Media Form: Die-cut label (Gap)	The paper being used differs from that of Media detection settings.	Check the paper being used and Media detection settings of the printer. (" <a href="#">Paper Source and Paper Detection Settings</a> " on page 91)
	The transmittance of the paper does not comply with the specifications.	If the transmittance of the paper differs, gaps may not be recognizable. Infrared light is used for gap detection, and the infrared transmittance of the backing paper needs to be the specified value or higher and the infrared transmittance of the label part needs to be the specified value or lower. Check the specifications of the paper, and use paper that complies with the printer specifications. (" <a href="#">Paper Specifications</a> " on page 344) The gaps may become recognizable by adjusting the label gap detector. On the operation panel, select [Menu] - [Maintenance] - [Calibration] - [Simple Media Detect] in that order. If the problem is not resolved, carry out [Media Detect].
	The sensor has failed.	If operation was normal up until now, the sensor has probably failed. Request repairs.
Paper is Fed and Ejected, and an Error Occurs  Media Form: Continuous Label (Black Mark), Die-cut Label (Black Mark)	The paper being used differs from that of Media detection settings.	Check the paper being used and Media detection settings of the printer. (" <a href="#">Paper Source and Paper Detection Settings</a> " on page 91)
	The black marks do not comply with the specifications.	If the reflectivity of the black marks is higher than the specified value, the black marks may not be recognizable. Infrared light is used for black mark detection, and the infrared reflectivity needs to be the specified value or lower. Check the specifications of black mark printing, and use black marks that comply with the printer specifications. The black marks may become recognizable by adjusting the black mark detector. On the operation panel, select [Menu] - [Maintenance] - [Calibration] - [Simple Media Detect] in that order. If the problem is not resolved, carry out [Media Detect].
	The sensor has failed.	If operation was normal up until now, the sensor has probably failed. Request repairs.

## Network Connection Check Errors

Check the error number printed on the connection check report and take measures correspond to the error number.

For instructions on how to print the report, see "[Checking Network Connection and Settings](#)" on page 36.

### Error Code

Error number	Solution
E-1	<ul style="list-style-type: none"> <li>• Check that the LAN cable is securely connected to the printer and the other network devices such as a hub.</li> <li>• Check that the network device such as a hub is powered on.</li> </ul>
E-2 E-3 E-7	<ul style="list-style-type: none"> <li>• Make sure that the access point is turned on.</li> <li>• Make sure that your computer or other devices are communicating properly with the access point.</li> <li>• Keep the printer and access point close together. Remove any obstacles in between.</li> <li>• If you entered the SSID directly, make sure that the SSID you entered is correct. You can check the SSID in the network settings column on the connection check report.</li> <li>• When setting up with push-button auto-configuration, make sure the access point supports AOSS/WPS. If the access point does not support AOSS/WPS, push button automatic setting cannot be used.</li> <li>• Make sure that the SSID does not use any character string other than ASCII characters (alphanumeric characters and symbols). The printer cannot display SSIDs that contain non-ASCII character strings.</li> <li>• When connecting to an access point, confirm the SSID and password beforehand. If you are using an access point with the manufacturer's settings, the SSID and password will be written on the label of the access point. If you don't know the SSID and password, check with the person who set up the access point, or refer to the manual for the access point.</li> <li>• If you want to connect to the SSID generated by the tethering function of your smart device or other devices, check the manual of your smart device for the SSID and password.</li> <li>• If you are suddenly unable to connect to your wireless LAN (Wi-Fi), check the following. If any of the following apply to you, please use the installer to reconfigure your network settings. The installer can be obtained from the following website. <a href="https://www.epson-biz.com/">https://www.epson-biz.com/</a> <ul style="list-style-type: none"> <li>• Have you newly set up your network environment with push-button auto-configuration (AOSS/WPS) from another smart device?</li> <li>• Has this wireless LAN (Wi-Fi) network been configured using a method other than push-button auto-configuration?</li> <li>• Are you using an access point manufactured by Buffalo Corporation that can be set up using push buttons (AOSS)?</li> </ul> </li> </ul>
E-5	<p>Check if the access point has one of the following security methods. If not, change the access point settings to use one of the following security methods, and reconfigure the network settings of the printer.</p> <ul style="list-style-type: none"> <li>• WEP-64 bit (40 bit)</li> <li>• WEP-128 bit (104 bit)</li> <li>• WPA PSK (TKIP/AES)*</li> <li>• WPA2 PSK (TKIP/AES)*</li> <li>• WPA (TKIP/AES)</li> <li>• WPA2 (TKIP/AES)</li> <li>• WPA3 SAE (AES)*</li> </ul> <p>* WPA PSK is also referred to as WPA Personal, WPA2 PSK as WPA2 Personal, and WPA3 SAE as WPA3 Personal.</p>

Error number	Solution
E-6	<ul style="list-style-type: none"> <li>• Make sure that MAC address filtering is disabled. If enabled, please register the MAC address of the printer to prevent it from being filtered. For details, please refer to the manual of the access point. You can check the MAC address of the printer in the network settings column on the connection check report.</li> <li>• If Shared authentication is enabled in the access point's WEP security method, make sure that the authentication key and index are correct.</li> </ul>
E-8	<ul style="list-style-type: none"> <li>• When the TCP/IP setting of the printer is set to automatic, enable DHCP on the access point.</li> <li>• When the TCP/IP setting of the printer is set to manual, the manually set IP address is invalid because it is outside the valid range (such as 0.0.0.0). Set a valid IP address using the operation panel of the printer or using WebConfig.</li> </ul>
E-9	<p>Check the followings.</p> <ul style="list-style-type: none"> <li>• Is the device that uses the printer turned on?</li> <li>• From the device that uses the printer, is it possible to access the Internet and connect to other computer or network devices on the same network?</li> </ul> <p>If there are no problems, please use the installer to reconfigure your network settings. The installer can be obtained from the following website.  <a href="https://www.epson-biz.com/">https://www.epson-biz.com/</a></p>
E-10	<p>Check the followings.</p> <ul style="list-style-type: none"> <li>• Are the other devices on the network turned on?</li> <li>• If you have set the printer's TCP/IP settings manually, is the network address (IP address, subnet mask, and default gateway) correct?</li> </ul> <p>If the network address is incorrect, correct it. You can check the IP address, subnet mask, and default gateway in the network settings column on the connection check report.  If you have enabled DHCP, set the IP address to Auto in the printer's TCP/IP settings. If you want to set the IP address manually, check the printer's IP address in the network settings column on the connection check report, then set the address in the printer's network settings screen. Set the subnet mask to "255.255.255.0".</p>
E-11	<p>Check the followings.</p> <ul style="list-style-type: none"> <li>• If you have set the printer's TCP/IP settings manually, is the default gateway address correct?</li> <li>• Is the device specified as the default gateway turned on?</li> </ul> <p>Set the correct default gateway address. You can check the default gateway address in the network settings column on the connection check report.</p>
E-12	<p>Check the followings.</p> <ul style="list-style-type: none"> <li>• Are the other devices on the network turned on?</li> <li>• Is the network address (IP address, subnet mask, default gateway) of the printer that you set manually correct?</li> <li>• Are the network addresses (subnet mask and default gateway) of other devices the same?</li> <li>• Is the IP address of the printer duplicated with other devices?</li> </ul> <p>If there are no problems, try the following.</p> <ul style="list-style-type: none"> <li>• On a computer on the same network as the printer, use the installer to reconfigure the network settings. The installer can be obtained from the following website.  <a href="https://www.epson-biz.com/">https://www.epson-biz.com/</a></li> <li>• The security type "WEP" allows multiple security keys to be registered to the access point. When multiple keys are registered, make sure that the security key for the first (primary) index is set to the printer.</li> </ul>

Error number	Solution
E-13	<p>Check the followings.</p> <ul style="list-style-type: none"> <li>• Are network devices (access points, hubs, routers, etc.) turned on?</li> <li>• Are the TCP/IP settings of network devices other than the printer set manually? (If the TCP/IP settings of other network devices are set manually, but only the printer's TCP/IP settings are set automatically, only the printer may be on a different network.)</li> </ul> <p>If there are no problems, try the following.</p> <ul style="list-style-type: none"> <li>• On a computer on the network to which the printer is connected, use the installer to reconfigure the network settings. The installer can be obtained from the following website.  <a href="https://www.epson-biz.com/">https://www.epson-biz.com/</a></li> </ul> <p>The security type "WEP" allows multiple security keys to be registered to the access point. When multiple keys are registered, make sure that the security key for the first (primary) index is set to the printer.</p>

## Messages about the network environment

Message	Solution
Multiple specified networks (SSIDs) were found. Please check.	There is a possibility that the same SSID is set for multiple access points. Please check the settings of the access point and change the SSID.
The wireless environment needs to be improved. Turn off the access point and then back on. If the problem persists, please refer to the manual of the access point.	Move the printer closer to the access point, turn off the access point and then back on. If the problem persists, please refer to the manual of the access point.
The maximum number of devices that can be connected wirelessly has been reached. If you want to add a device, please disconnect other devices.	Up to 8 wireless devices can be connected at the same time via Wi-Fi Direct (Simple AP) connection. To add another computer or smart device, disconnect the computer or smart device that is not using the printer before adding it.

## Unable to Connect to the Network

---

### **There is some problem with the wireless LAN network device(s)**

Turn off the power of all devices connected to the network. Wait about 10 seconds, then turn on the wireless router (access point), computer or smart device, and printer, in that order. Move the devices closer to the wireless router (access point) so that they can receive radio waves more easily, and reconfigure the settings.

---

### **The devices and the wireless router are too far apart to receive a signal**

Move the computer or smart device and printer closer to the wireless router, and then turn the router back on.

---

### **You have replaced the wireless LAN router, but the connection settings have not been changed**

Reconfigure the settings to match the new router.

---

### **The SSID connected to the computer or smart device is different from that of the printer**

If you are using multiple wireless LAN routers or one wireless LAN router that can use multiple SSIDs, you will not be able to connect if the SSID that your computer or smart device is connected to is different from the SSID that the printer is connected to. Connect your computer or smart device to the same SSID.

---

### **The privacy separator function of the wireless LAN router is enabled**

Many wireless LAN routers (access points) and mobile routers have a privacy separator function that blocks communication between devices. If you cannot communicate between the printer and your computer or smart device even though they are connected to the same SSID, disable the privacy separator function on your wireless router (access point). For details, refer to the manual of your wireless router (access point).

---

### **The IP address has not been assigned correctly**

If the IP address is "169.254.XXX.XXX" and the subnet mask is "255.255.0.0", the IP address may not have been assigned correctly. On the printer's operation panel, select [Settings] - [Network Settings] - [Advanced], and check the IP address and subnet mask assigned to the printer.

Restart the wireless router or reconfigure the network settings of the printer.

---

### **There is a problem with your computer's network settings**

Make sure you can browse the website from your computer. If you cannot, there is a problem with your computer's network settings.

Check your computer's network connection. For more information, refer to your computer's manual.

## A message is displayed on the computer screen

If the following screen appears, resolve the problem following the instructions on the screen.

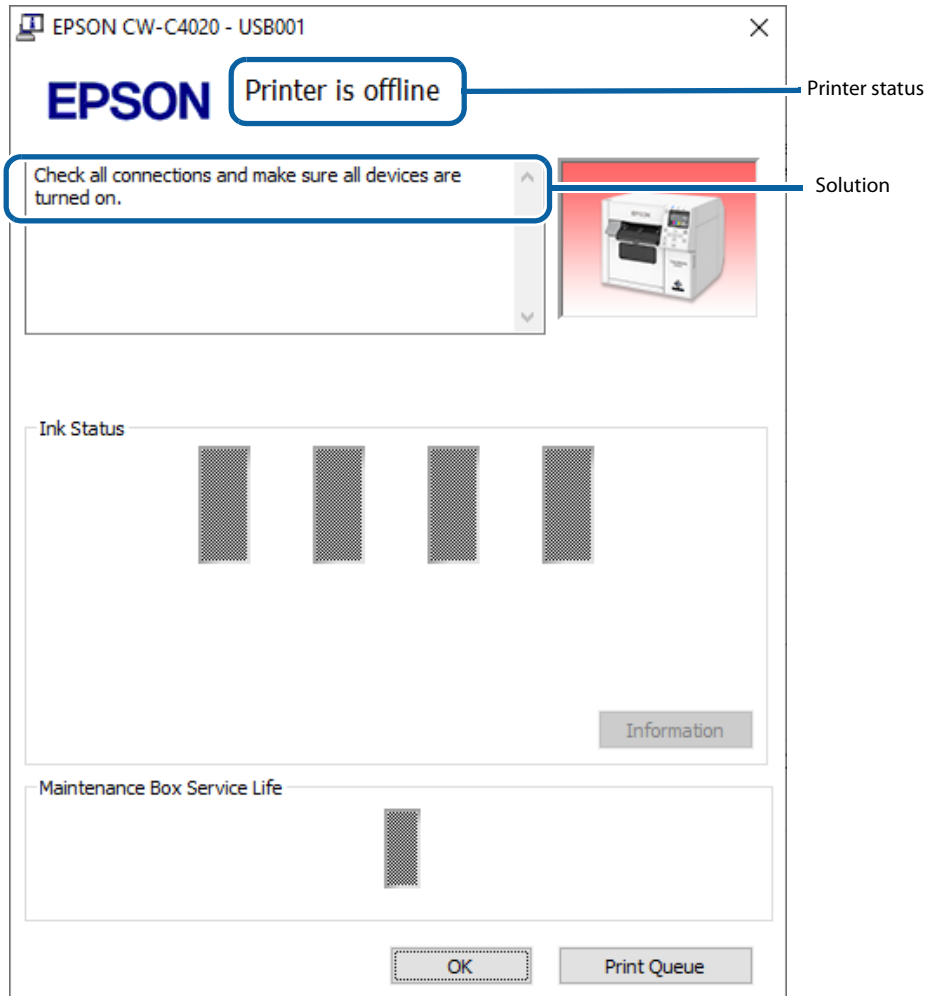

## Printing from a computer is impossible or becomes suddenly impossible

### Checking Whether the Printer Driver Is Installed

Check whether or not the required software and applications are installed on the computer.

To print with this printer, a printer driver is required. Check whether or not the printer driver is installed by following the steps below.

- 1 Display Devices and Printers on the computer.**
- 2 Check that the printer name is displayed.**  
If not, the printer driver is not installed.
- 3 Install the printer driver.**  
(["Downloading Printer Driver, Utilities, and Manuals" on page 365](#))

### Reconnecting the Printer and Computer

- 1 Check the cable connections.**  
Check that the power cable and the USB cable or wired LAN cable are connected properly.  
If the connection was made wirelessly, check that the wireless LAN unit is inserted correctly.
- 2 Reconnect all of the devices.**  
For USB connection
  - Disconnect the USB cable and then reconnect it.
  - If the computer has multiple USB ports, connect the cable to a different port.
 For wired LAN connection
  - Device connected by wired LAN may have become unstable. Restart the network function.
  - Turn off the all devices.
  - Wait about 10 seconds, then turn on the network device, computer, and printer in that order.
 For wireless LAN connection
  - Disconnect the optional wireless LAN unit and reconnect it.
  - Turn off the all devices.
  - Wait about 10 seconds, then turn on the network device, computer, and printer in that order.
- 3 Check that data is sent from the computer to the printer.**  
For the check procedure, see ["Checking the Print Data" on page 313](#).



---

## Checking the [Devices and Printers]

If the printer icon is not displayed in the [Devices and Printers] window, the printer device may have been deleted. Add the printer again following the procedure below.

- 1 Turn off the printer.**
- 2 Disconnect the USB cable from the computer.**
- 3 Wait for about 10 seconds, and then reconnect the USB cable to the computer.**
- 4 Turn the printer on.**  
The printer icon is now displayed in the [Devices and Printers] window.

---

## Checking the Print Data

If print data is not sent from a computer to the printer, it may be caused by print jobs remaining on the computer, or print jobs that has been paused or offline setting.

Check it following the procedure below.

- 1 Display Devices and Printers on the computer.**
- 2 Set the printer as the default printer.**  
Right-click the icon of the printer to be used and then click Set as default printer.  
If the printer is installed multiple times, copies of the printer driver may be created.  
If there is more than one printer icon and you find a copied one such as "CW-C40XX (Copy 1)", right-click on the copied icon and then delete it by clicking Remove device.
- 3 Perform a test print to check whether or not the print data is sent to the printer.**  
Right-click the icon of the printer being used and then click Printer properties.
- 4 The printer properties screen of the printer driver appears. Click Print Test Page on the General tab.**  
If the test print is successful, you have confirmed that data is sent from the computer to the printer.
- 5 Display the print job. Right-click the icon of the printer being used and then click See what's printing.**
- 6 A screen appears. Check the print job.**  
If print data is displayed, select [Printer] - [Cancel All Documents].  
If the print data cannot be deleted, restart the computer.
- 7 Check "Pause Printing" or "Use Printer Offline" is not set for the printer.**  
Select Printer and make sure that "Pause Printing" or "Use Printer Offline" is not checked. If any of them is checked, clear the check mark.



---

## The printer does not turn on

Check that the power cable is connected to the printer and outlet properly. (["Connecting the Power Cable" on page 41](#))



## Print Job is Canceled on PC but "Printing" Message on Printer Does Not Disappear

If you cancel printing in printer queue on the computer, it may cause the print data to break up and "Printing" may be kept displayed on the operation panel of the printer.

To cancel this state, press the  (Pause) button on the operation panel, then press the  (Cancel) button, and then perform [Format All].

If you are still unable to cancel after performing the above steps, restart the printer.

## Error Beep Sound Does Not Stop

If the printer has been set to sound the error beep continuously, press the  (home) button or the  (back) button on the operation panel to stop the beep sound.

## Paper Jam

### Roll Paper is Jammed

- 1 Open the front cover.

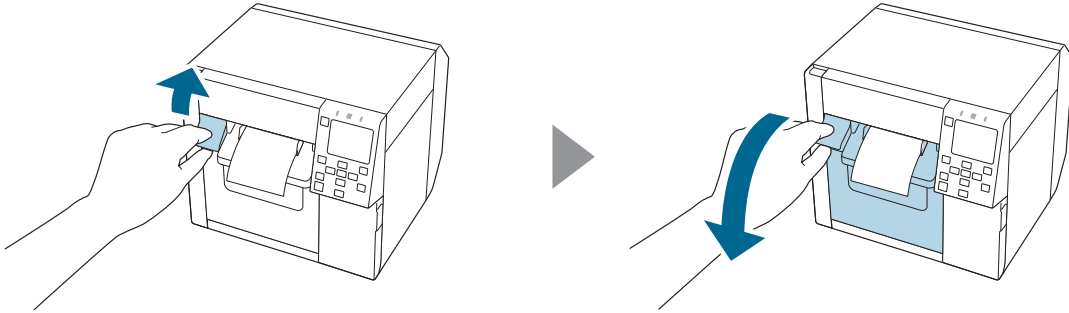

- 2 Remove the jammed paper.

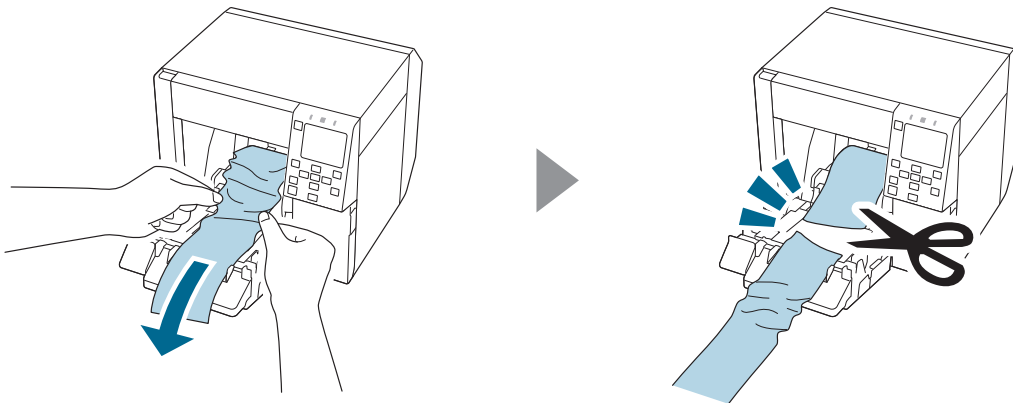

- 3 Pull out the leading edge of the roll paper, and then close the front cover.

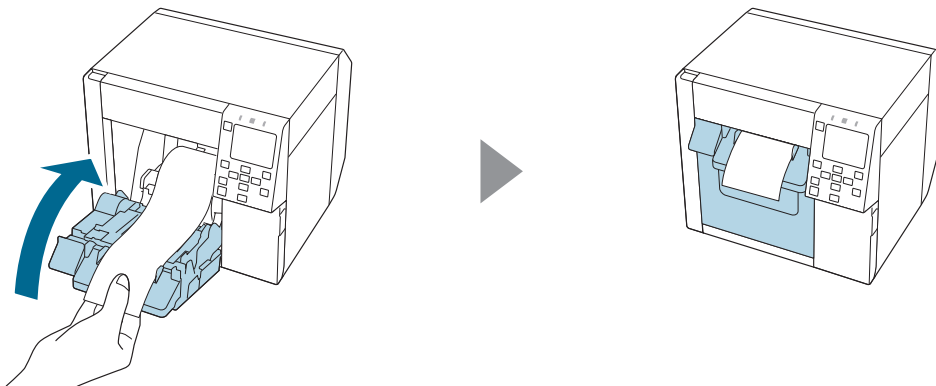

#### 4 Press the **||** (Pause) button.

Check that the printer is ready for printing by checking the home screen.

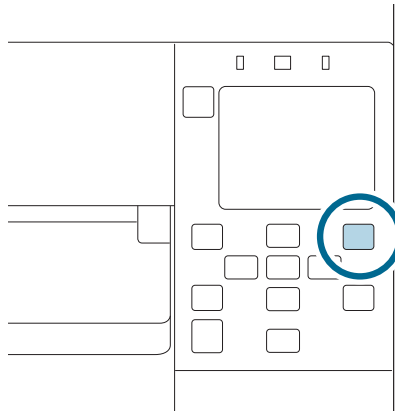

After removing jammed paper, make sure that there is no labels or adhesive left inside the printer. If you use the printer without removing them, it leads to frequent paper jams, or may cause poor print quality.

If paper jam occurs frequently, clean the inside of the printer.  
(["Cleaning the Printer" on page 286](#))

## Fanfold Paper is Jammed

- 1 Open the front cover.

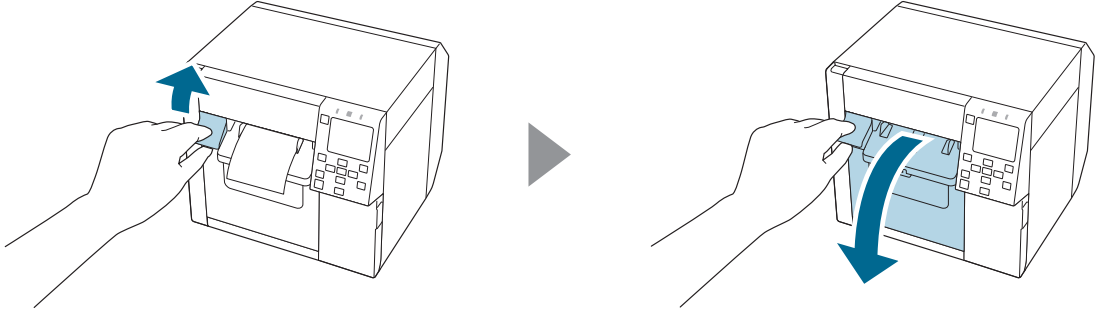

- 2 Cut out the jammed paper.

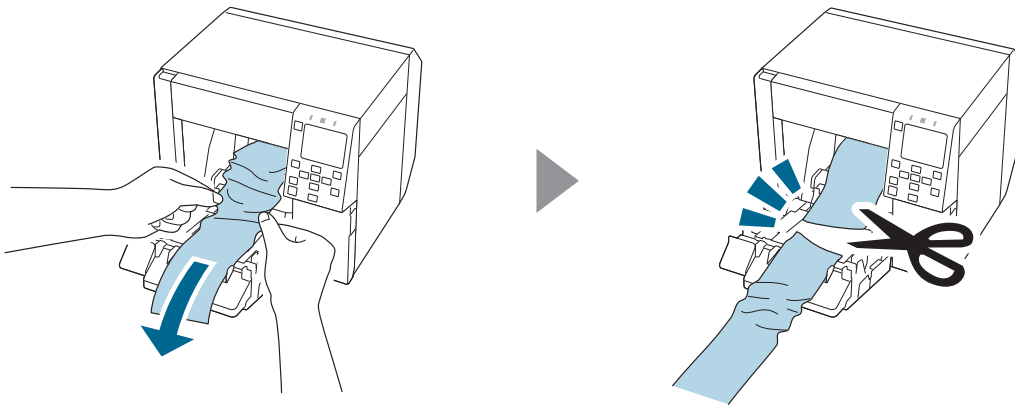

- 3 Open the rear cover and then remove the jammed paper.

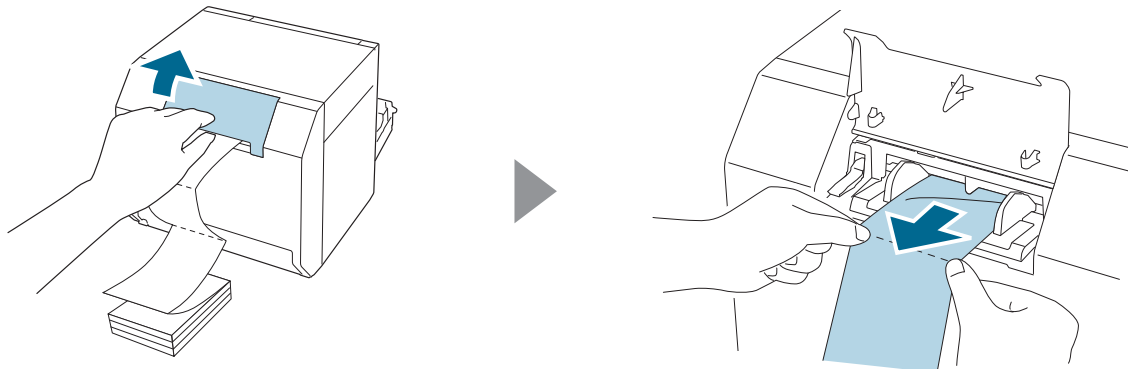

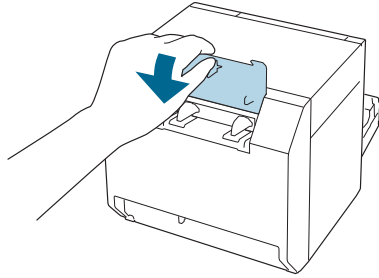
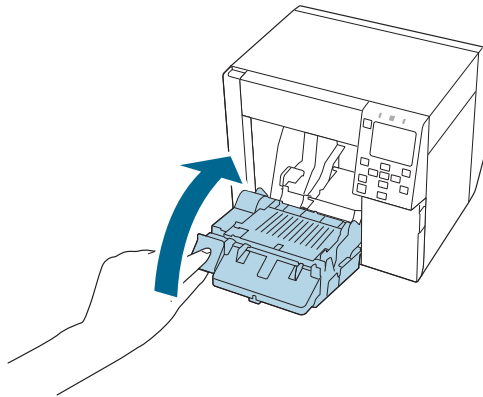
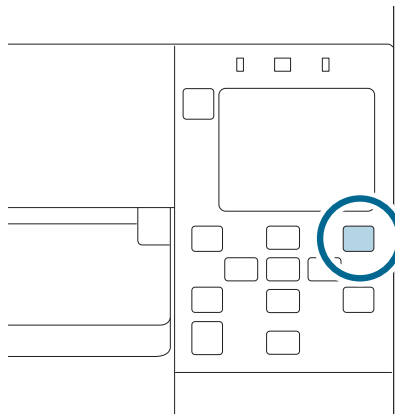
**4** Close the rear cover.**5** Close the front cover.**6** Press the **||** (Pause) button.

After removing jammed paper, make sure that there is no labels or adhesive left inside the printer. If you use the printer without removing them, it leads to frequent paper jams, or may cause poor print quality.

If paper jam occurs frequently, clean the inside of the printer.  
(["Cleaning the Printer" on page 286](#))

# Information for Application Development

This chapter provides printer control methods and other information necessary for developing an application.

## How to Control the Printer

The printer control method differs depending on how to print from the printer.

Application specifications	Printer control method	Page
Print using the printer driver that is installed following the setup workflow described in chapter 2.	Use the printer driver.	<a href="#">Page 84</a>
Print using the Epson Inkjet Label Printer SDK from Windows applications you developed.	Use the Epson Inkjet Label Printer SDK commands.	<a href="#">Page 320</a>
Print using your application that directly controls ESC/Label commands.	Use the ESC/Label commands.	<a href="#">Page 321</a>
Print using an existing application and printer driver that were used for a ZPL II compatible monochrome printer. Change from preprint system to on-demand print system.	Change the printer settings to replace the printer.	<a href="#">Page 324</a>
Print using a Linux driver that has been rebuilt from the Linux driver source code to match the Linux OS of the distribution you are using.	Use the rebuilt printer driver for Linux.	<a href="#">Page 180</a>
Print using the Linux driver source code from your application.	Use the source code of the Linux driver.	<a href="#">Page 180</a>
Print using the iOS SDK from iOS applications you developed.	Use the iOS SDK.	<a href="#">Page 321</a>
Print using the Android SDK from Android applications you developed.	Use the Android SDK.	<a href="#">Page 321</a>
Print using the Web Application SDK from Web applications you developed.	Use the Web Application SDK.	<a href="#">Page 321</a>

## Using the Epson Inkjet Label Printer SDK

The SDK provides you an environment required for your application to print through the Epson printer driver. The followings are included.

Item	Description
Epson Inkjet Label Printer SDK User's Guide	Describes overview of Epson Inkjet Label Printer SDK configuration, functions required for controlling the Epson inkjet label printer from an application, how to use the sample programs, and printer driver settings that need to be configured in advance.
EPDI (EPSON Printer Driver Interface)	EPDI (EPSON Printer Driver Interface) provides application programming interfaces of Epson printer driver. By using the EPDI, you can configure the Epson printer driver settings from your application.  For details about EPDI and information necessary to use it on your application programming, see "EPDI for Inkjet Label Printer Reference Guide" included in this SDK.
EpsonNet SDK	EpsonNet SDK provides API commands to get status of Epson inkjet label printer. For details about the API and information necessary to use it on your application programming, see "EpsonNet SDK for Windows Reference Guide" included in this SDK.
Label Print Sample Program	Provides executable files and source files of the program that perform printing from Epson inkjet label printer using Epson Inkjet Label Printer SDK. For instructions on how to use the sample programs, see "Epson Inkjet Label Printer SDK User's Guide".

### Operating Environment

OS	Refer to the Appendix.
Software	Printer driver (Download from the web site or install using Install Navi that is launched from the supplied CD*.)  *Depending on country or region, the CD does not come with the printer.

### How to Get Software

Contact qualified service personnel.



## *Using the iOS SDK/Android SDK/Web Application SDK*

The SDKs are development kits for controlling an ESC/Label command-enabled printer from a web application or a native application on a smart device. They include library, manual, sample programs, etc.

### How to Get

Follow the instructions in the URL below to get them.

<https://www.epson-biz.com/>

## *Using the ESC/Label Commands*

The ESC/Label commands allow you to print directly from your application without using the printer driver. For more details about ESC/Label commands, contact qualified service personnel.

## Replacing from ZPL II Compatible Monochrome Printer

If you want to print from the printer using an existing application and printer driver that were used for a ZPL II compatible monochrome printer, you need to change the printer settings so that they match with the settings of the ZPL II compatible monochrome printer.

### Changing from Two-Step Printing to One-Step Printing

CW-C4000 Series allow you to register an image file in png format to the printer, and print data sent from a host computer overlaying the registered image on the print data.

For example, if you had created color labels in two steps as described below, you can change it to one step without changing the system and data on the host computer.

Step 1. Purchasing label paper preprinted in color from a printing company.

Step 2. Printing monochrome data on the preprinted paper using ZPL II compatible monochrome printer.

#### Conventional Printing Method (Preprinting + Monochrome)

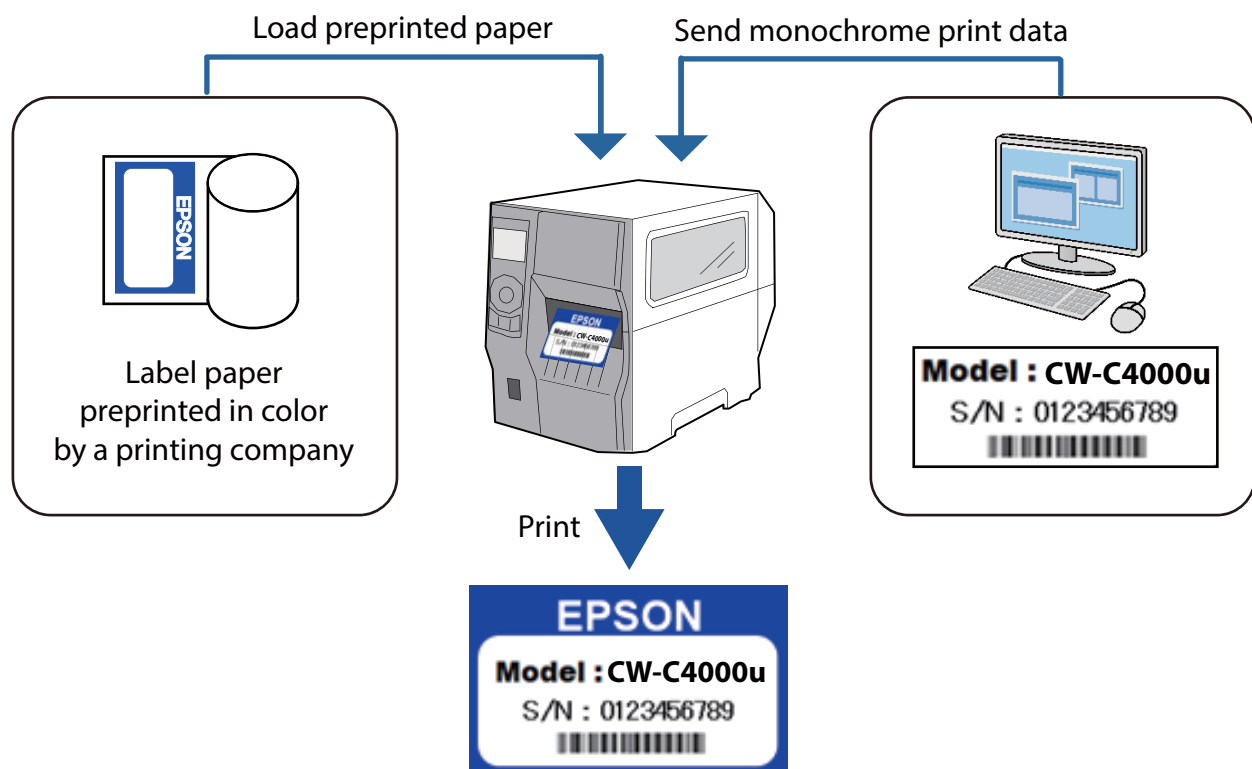

### One Step Printing Method with CW-C4000 Series

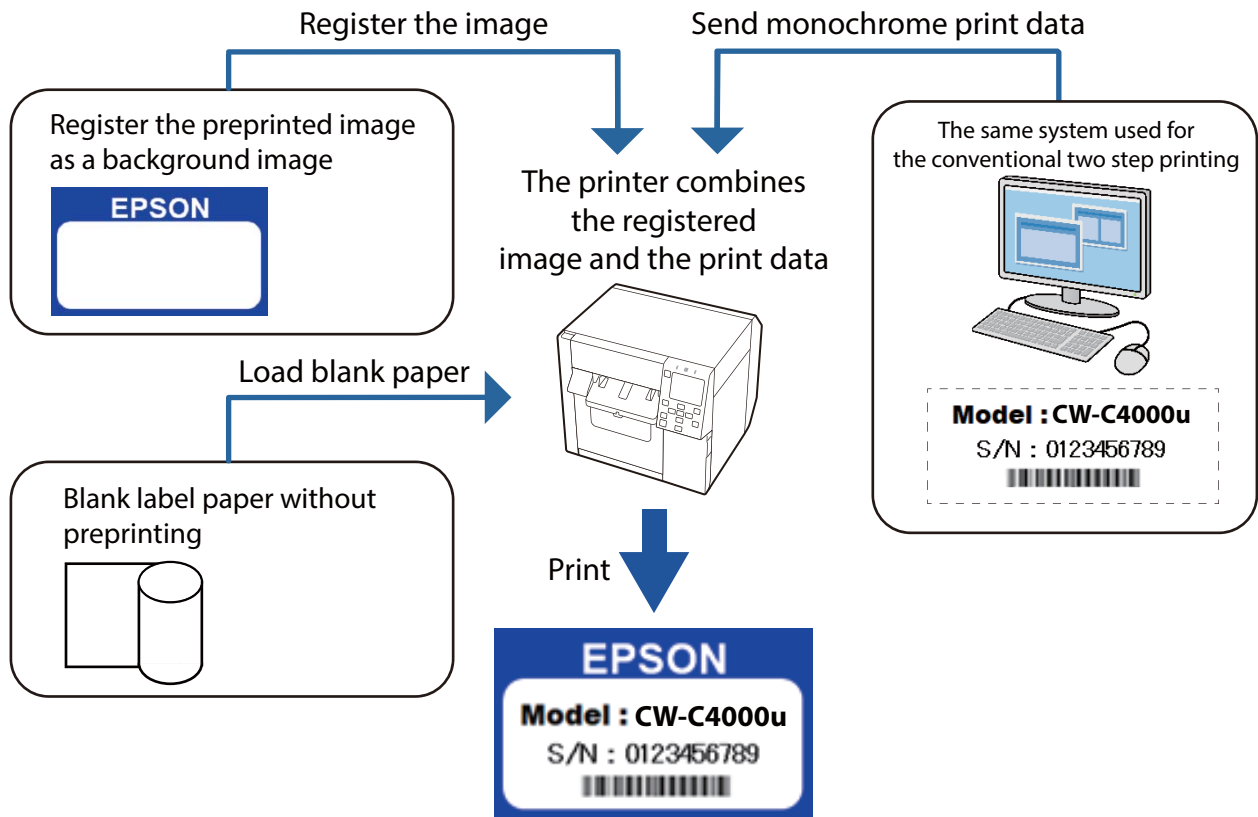

## Changing Printer Settings and Replacing Printer

Follow the flowchart below.

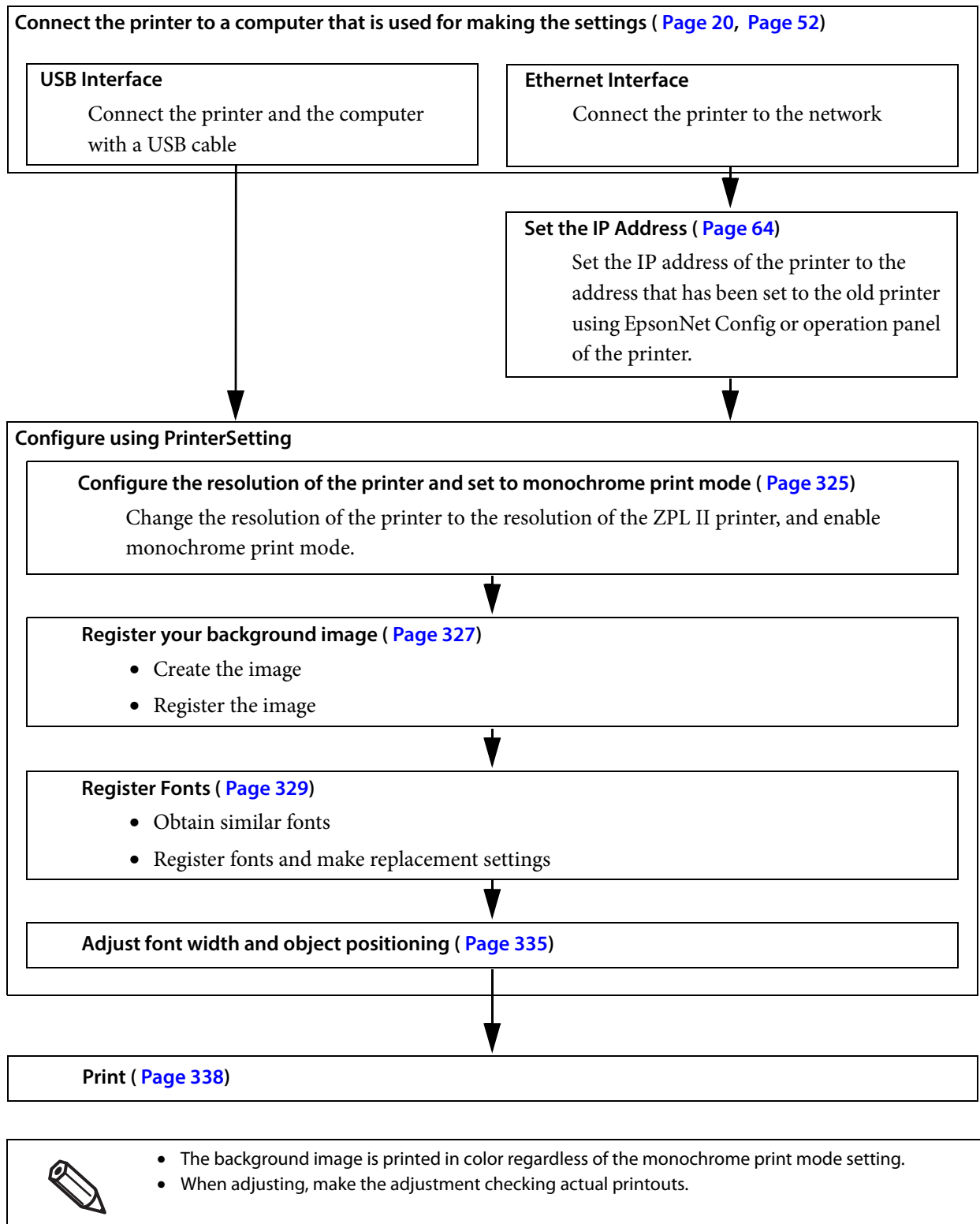

## Setting the Printer Resolution and Monochrome Print Mode

- 1 Start PrinterSetting.
- 2 Select [Advanced settings] from the [Detailed settings] menus, then click [Set...] beside the [Replace settings from printer using ZPL II commands:] option.

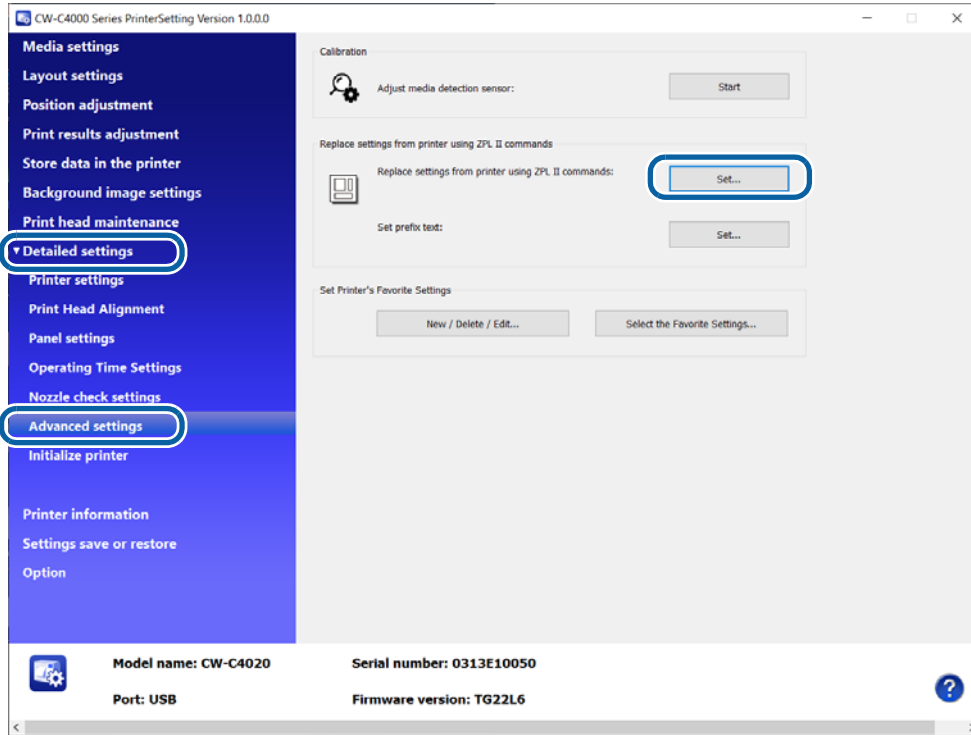

The "Replace settings from printer using ZPL II commands" window appears.

- 3** Select the resolution in the [Resolution of the printer in use:] pull-down menus. If the same resolution is not found in the menus, select one of the closest resolution. For example, if the resolution of the ZPL II compatible monochrome printer you were using is 203 dpi, select 200 dpi.

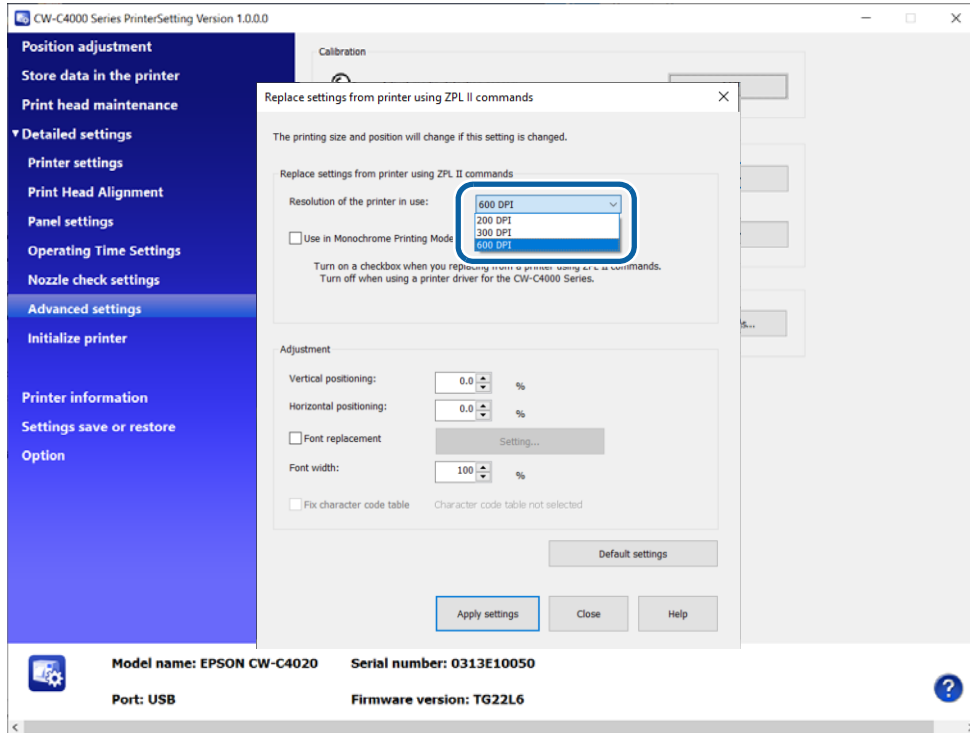

- 4** Select the checkbox for [Use in Monochrome Printing Mode] to print only in black and white and not print in color after replacing from the ZPL II compatible monochrome printer.

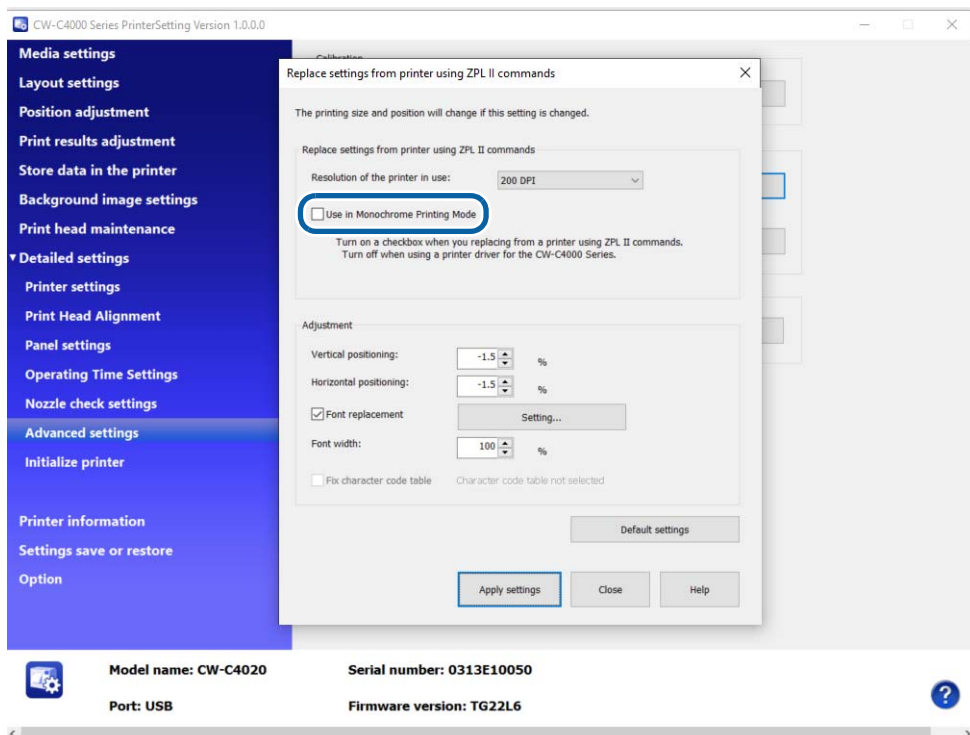

## Registering a Background Image

- 1** Create an images to be used as a background image.  
Use an image-editing software, save the background image in png format.  
Make sure to set the image resolution to 600 dpi.
- 2** Start PrinterSetting.
- 3** On the [Store data in the printer] window, click [Store...] in the [Image (Only .png)] field.  
The “Store image” window appears.
- 4** Specify the png image file to be stored, and then click [Set].

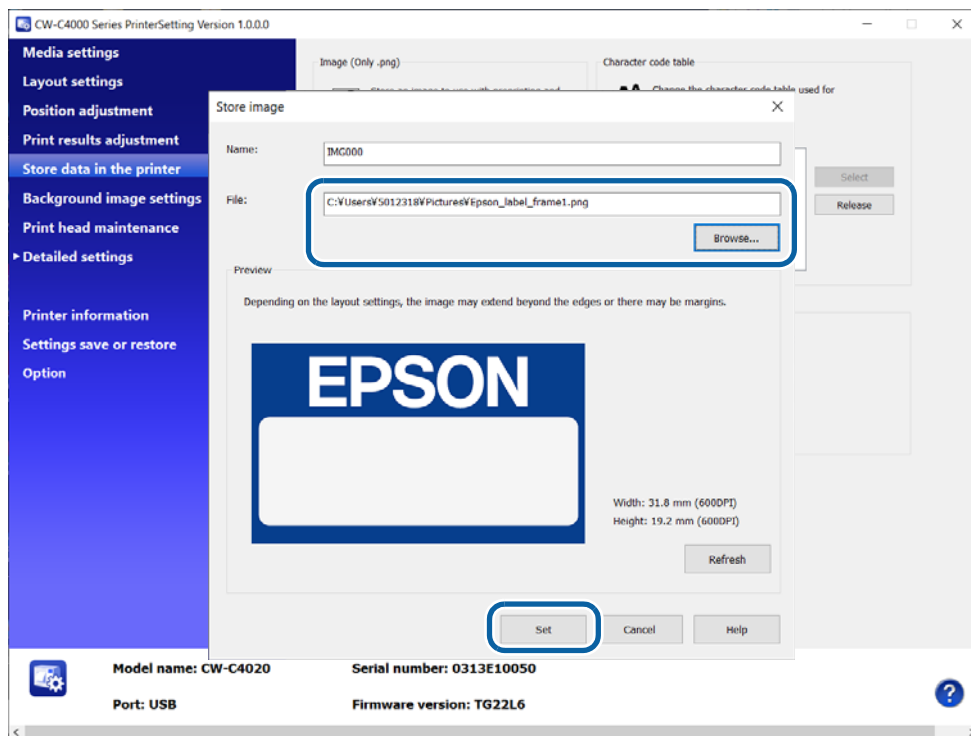

The image file is sent to the printer and stored as a background image.

- 5 On the [Background image settings] window, select the stored image to use in the [Set background image] field.

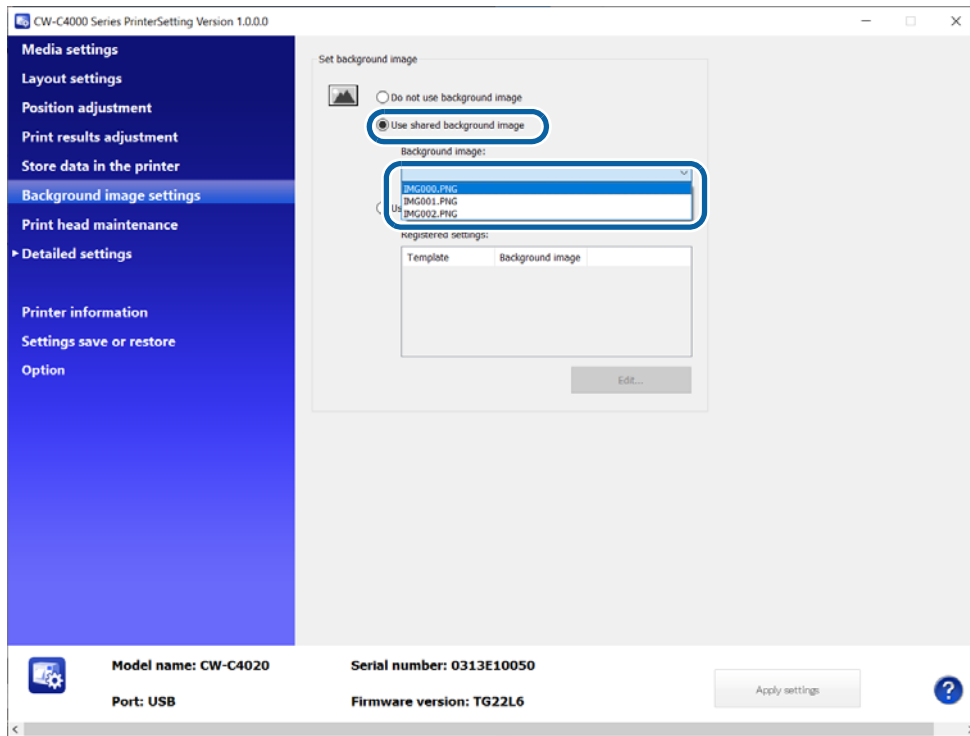



## Registering Fonts

### Font Registration Function

CW-C4000 Series and ZPL II compatible monochrome printers have built-in fonts. CW-C4000 Series have Epson original built-in fonts and they are different from the fonts on the ZPL II compatible monochrome printers.

Since the font style (shape and thickness) and space around the font (causes changes in character spacing) of printed characters depend on the type of the built-in font, there may be differences in print results between CW-C4000 Series and ZPL II compatible monochrome printers.

**Example:**

**Print results of ZPL II compatible monochrome printer**



**Print results of CW-C4000 Series**



To get print results close to the results of ZPL II compatible monochrome printer, CW-C4000 Series provide the functions to register fonts and replace fonts of the ZPL II printer with similar fonts.

### Getting Similar Fonts

Prepare fonts (file format is TTF) similar to the built-in fonts on the ZPL II compatible monochrome printer. There are the following fonts that are similar to the fonts on ZPL II compatible monochrome printers. Since there are lot of fonts that differ in character thickness and spacing, carefully choose optimum fonts. Please get fonts and their licenses on your own responsibility.

Similar Fonts (Typical Example)

Font Name	Type Examples
Swiss 721	Black, Black Condensed
Helvetica	Bold, Bold Condensed

## Registering/Replacing Fonts

- 1 Start PrinterSetting.
- 2 On the [Store data in the printer] window, click [Store...] in the [Font (Only .ttf and .tte)] field.

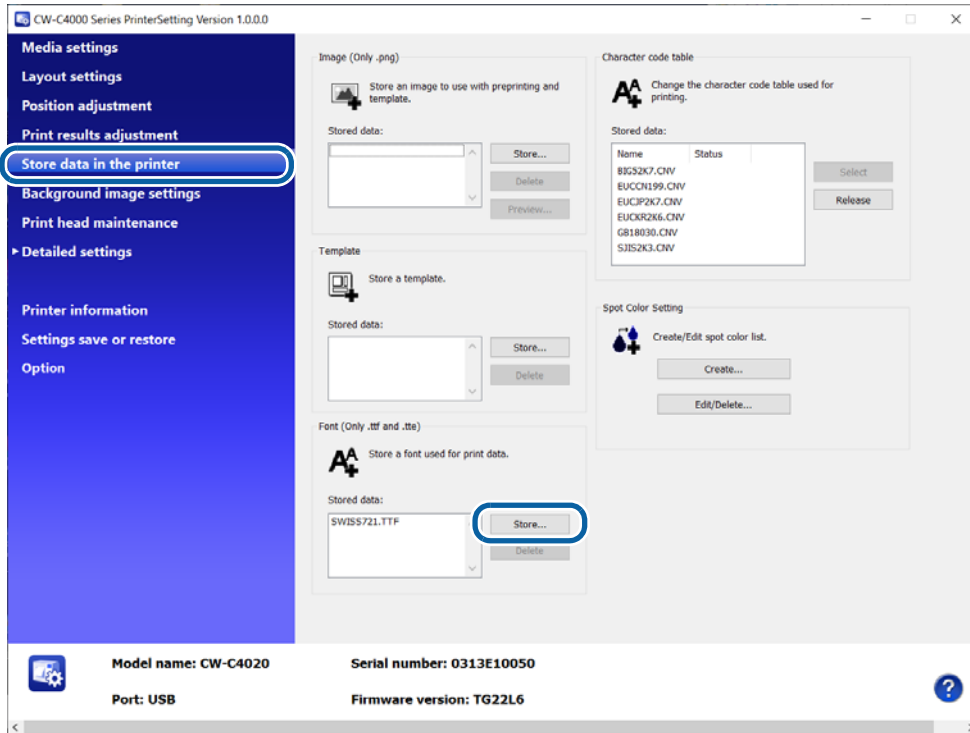

The "Store font" window appears.

- 3 Specify the font file (TTF format) to be stored, and then click [Set].**  
The font file is sent to the printer and stored as a built-in font.

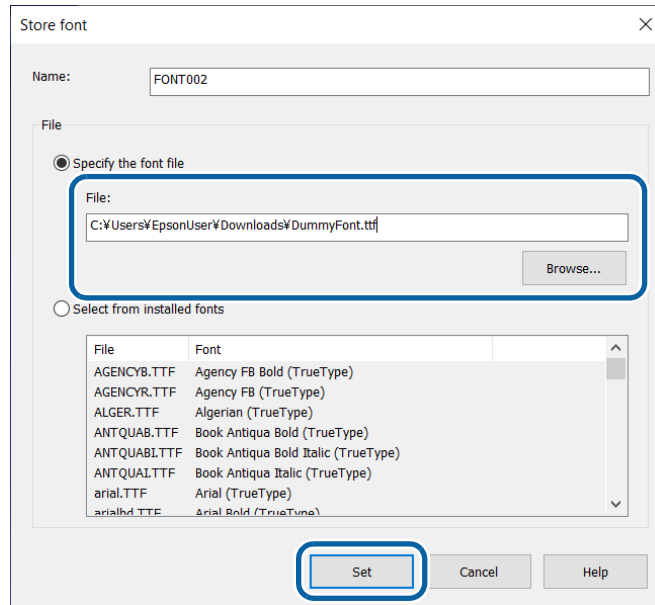

- 4 Select [Advanced settings] from the [Detailed settings] menus, then click [Set...] beside the [Replace settings from printer using ZPL II commands:] option.**

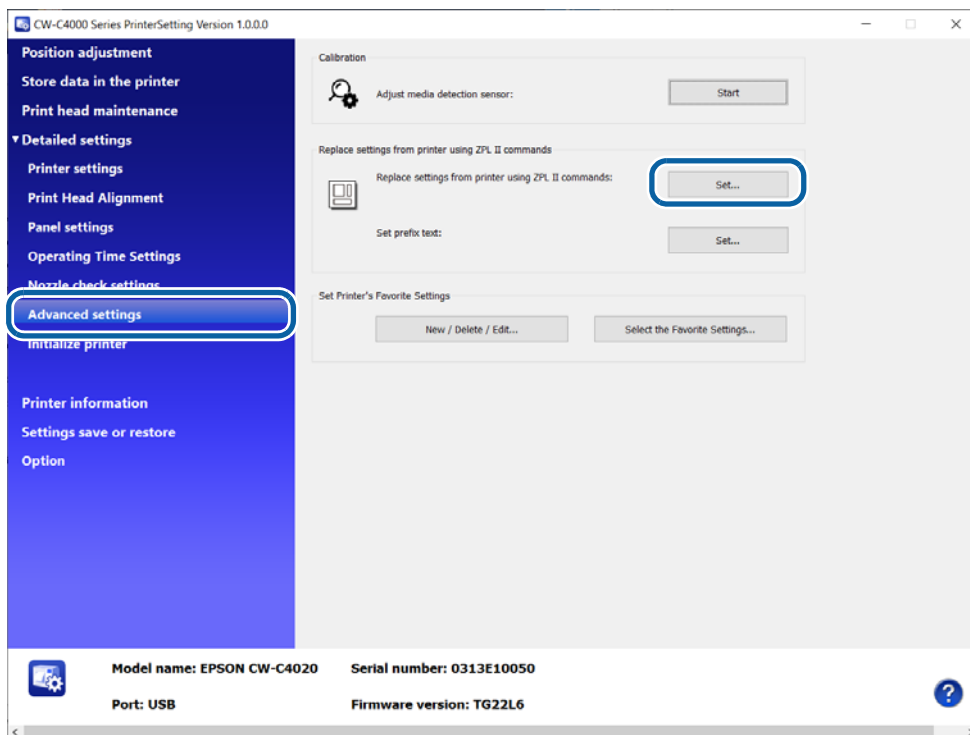

- 5 On the [Replace settings from printer using ZPL II commands] window, click [Settings] beside [Font replacement].

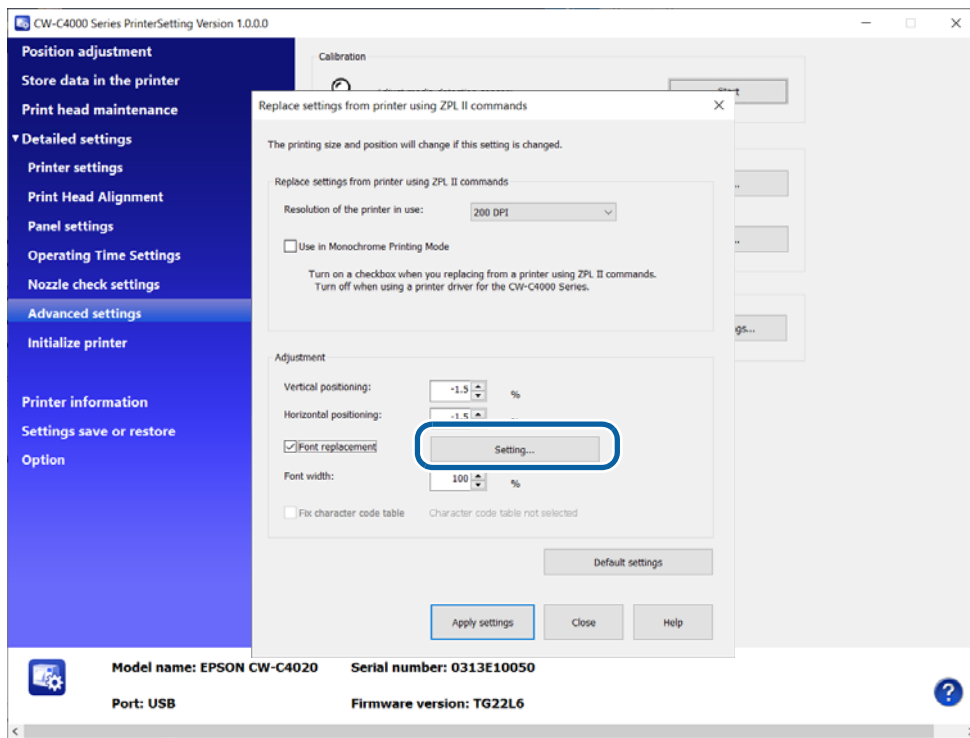

- 6 Select the font on the ZPL II compatible monochrome printer to be replaced by specifying the ID of the font. Select the ID from the list box.

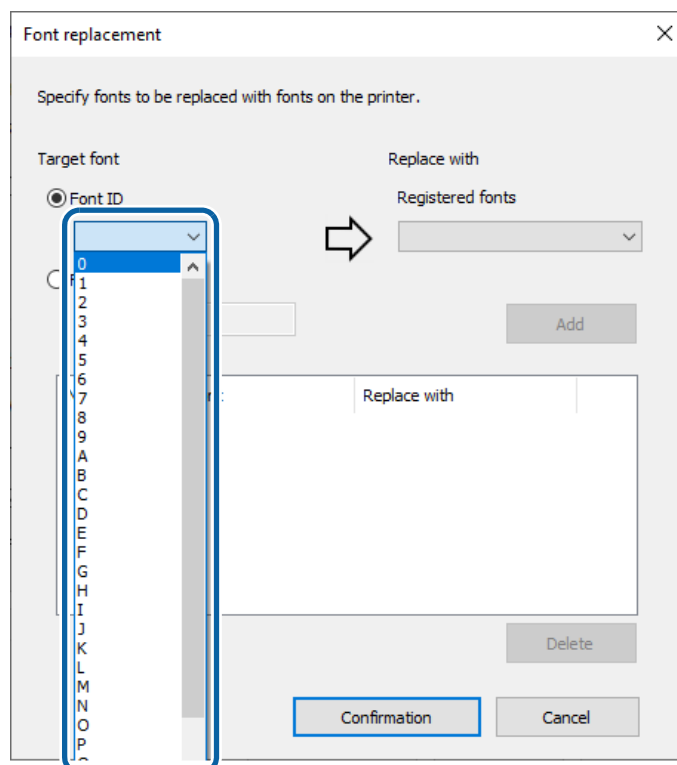

## 7 Select a font to be associated to the font ID.

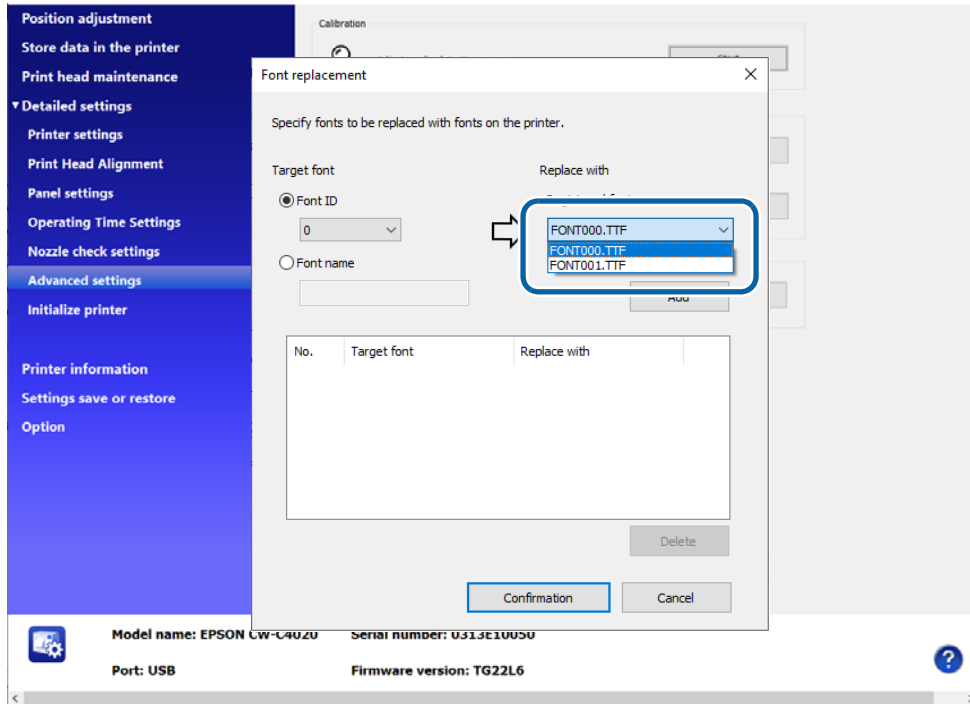

## 8 Click [Add] to add the pair to the list in the window. Click [Confirmation] to save the list and go back to the "Replace settings from printer using ZPL II commands" window.

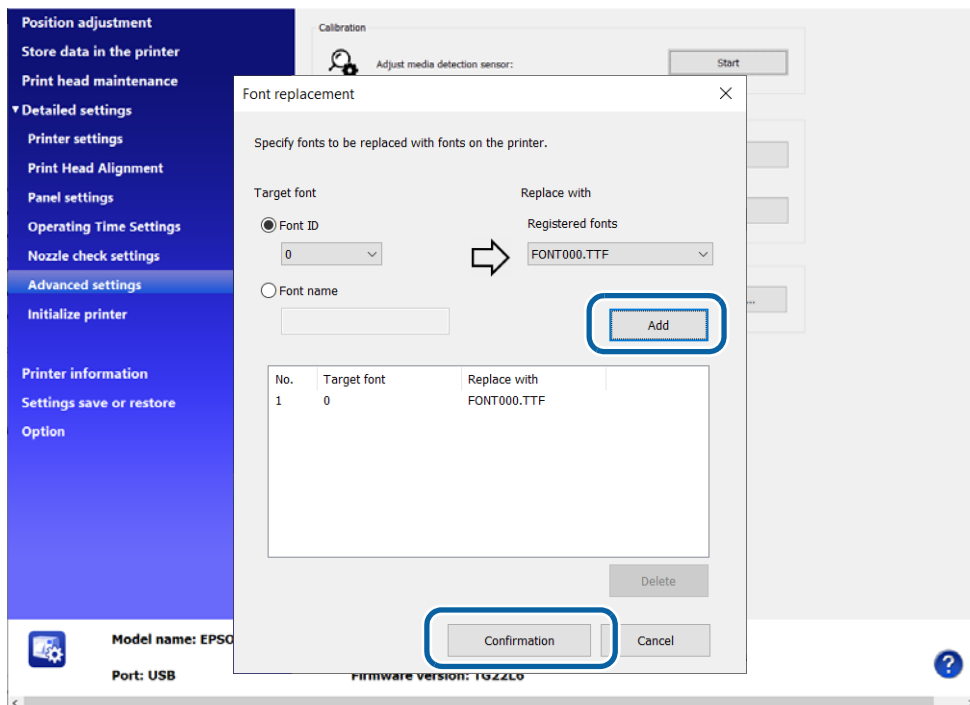

## 9 Select the check box for [Font replacement] to apply the font replacement settings.

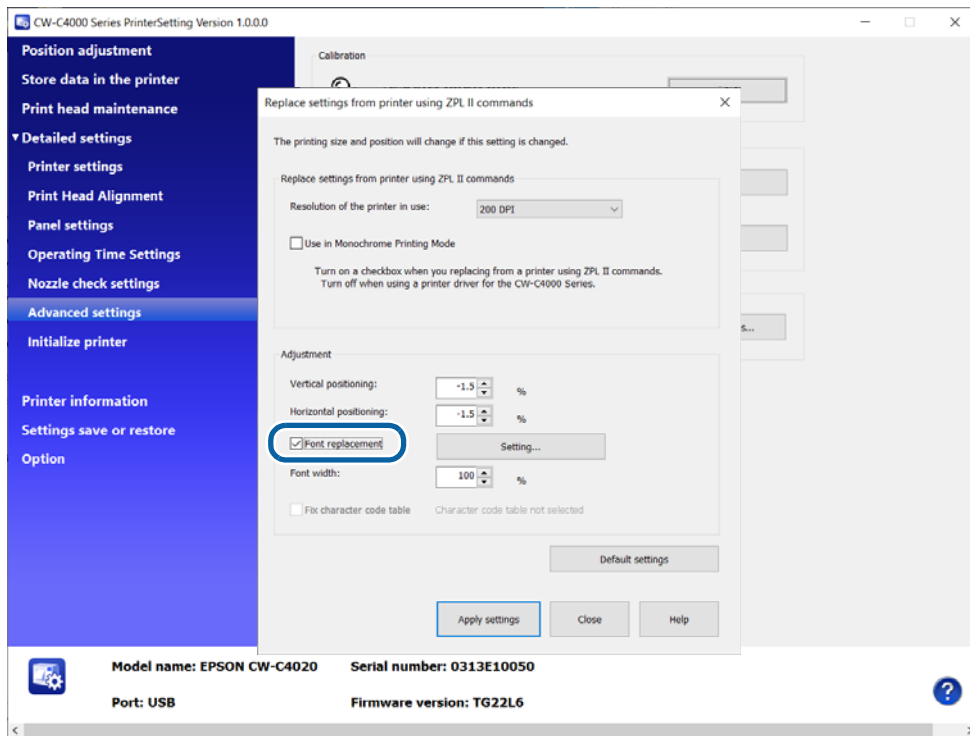

## 10 Click [Apply settings].

The settings are sent and set to the printer.

## Adjusting Font Width and Object Positioning

The following adjustments are provided in the [Replace settings from printer using ZPL II commands] window.

### Font width

This allows you to reduce width of font. “100%” is the original size. You can specify how much to reduce the width in increments of 1%. If you reduce the width too much, printed characters may become illegible. When you change the setting, check actual printouts. It is expected that the allowable range is 80 to 100%.

### Vertical Positioning

This allows you to adjust vertical print position of objects, such as a text, barcode, graphic, and image, on a single page. The setting can be changed in the range of -5.0 to + 5.0% in increments of 0.1%.

### Horizontal Positioning

This allows you to adjust horizontal print position of objects, such as a text, barcode, graphic, and image, on a single page. The setting can be changed in the range of -5.0 to + 5.0% in increments of 0.1%.

If CW-C4000 Series prints labels in 200 dpi, which had been printed in 203 dpi by the ZPL II compatible monochrome printer, the objects are printed being enlarged by 1.5% (203 divided by 200). Use the Vertical/Horizontal positioning functions to compensate position gaps caused by the difference in print resolution. Note that the positioning functions adjust only position of objects and do not change dimensions of the objects. This is to prevent the objects from being deformed. Especially for a thin line and barcode objects because scaling them down can result in disappearance of the line and drop in readability of the barcode.

In most cases, objects can be properly positioned with this functions, however, if there is a too large object comparing to the page size, or if gaps between multiple objects are too narrow, objects may be printed overlapping with each other resulting in printing labels different from the original label design.

### Objects on a page

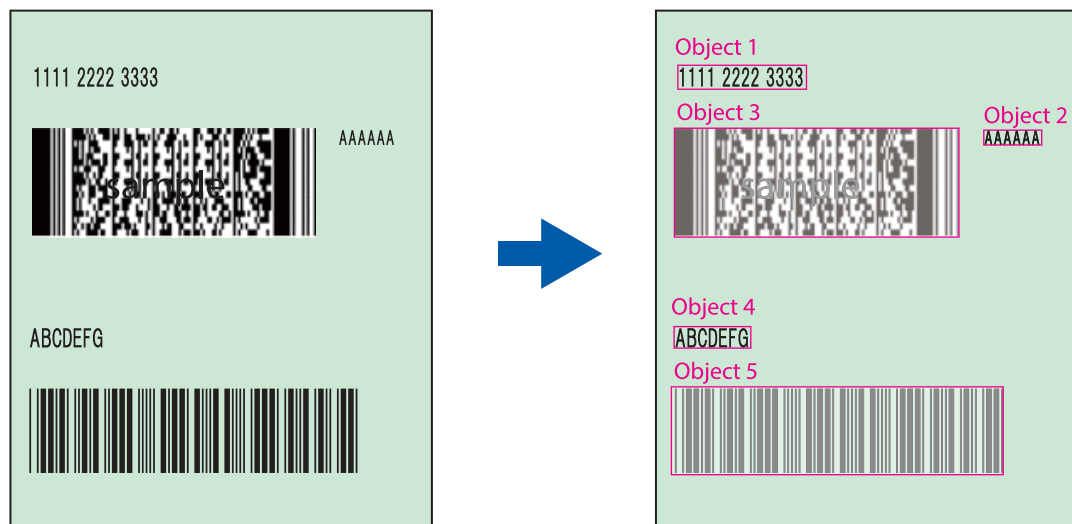

Example when scaled down by 1.5% both vertically and horizontally with the positioning functions

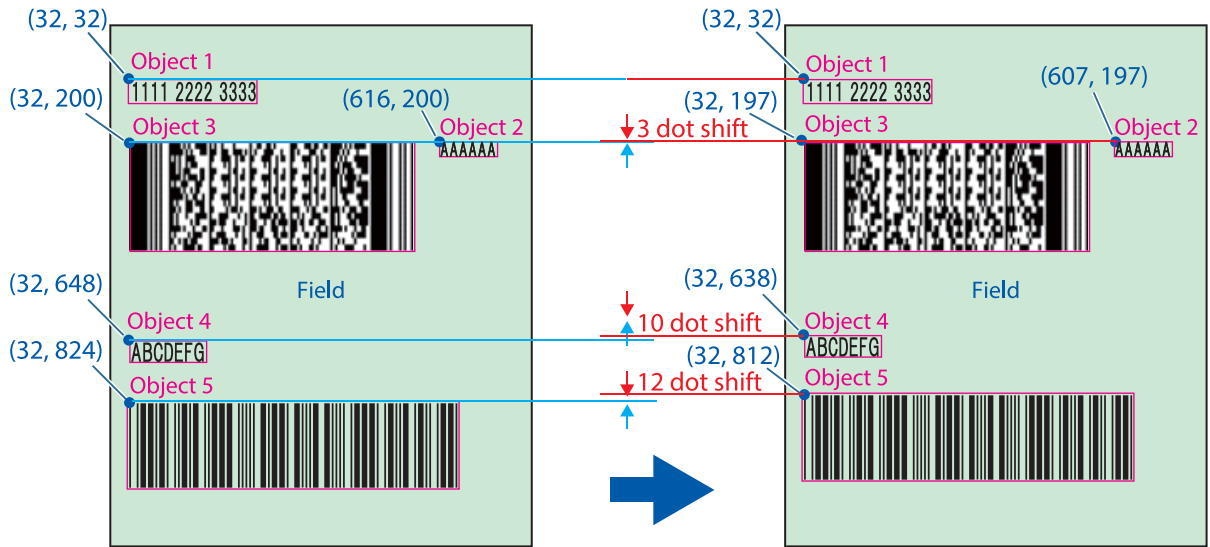

**Ex:** Object 2:  $616 \times 0.985 = 606.8$   
 $200 \times 0.985 = 197.0$   
 Object 4:  $32 \times 0.985 = 31.5$   
 $648 \times 0.985 = 638.3$

- 1 Start PrinterSetting.
- 2 Select [Advanced settings] from the [Detailed settings] menus, then click [Set...] beside the [Replace settings from printer using ZPL II commands:] option.

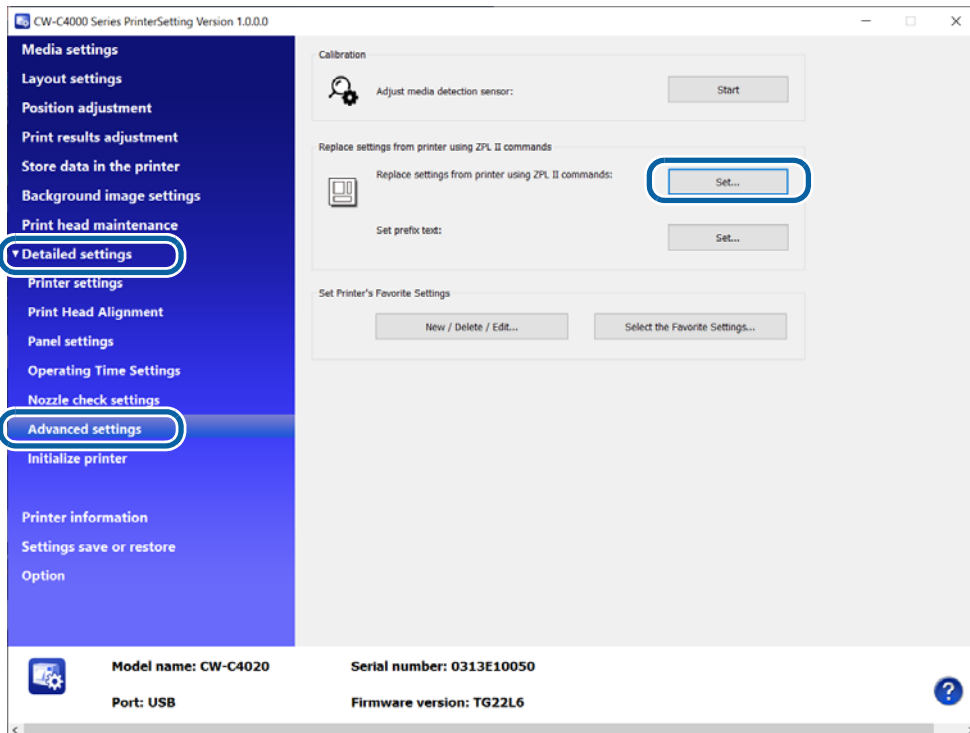

The “Replace settings from printer using ZPL II commands” window appears.



- 3 Select a value in each of the Vertical positioning and Horizontal positioning boxes.**  
If you have set the same resolution as the resolution of the ZPL II compatible monochrome printer, set "0" (zero) to both the [Vertical positioning] and [Horizontal positioning].  
If the resolution of the ZPL II compatible monochrome printer you were using is 203 dpi, and you have set the resolution to 200 dpi, set "-1.5%" to both the [Vertical positioning] and [Horizontal positioning].

Replace settings from printer using ZPL II commands

The printing size and position will change if this setting is changed.

Replace settings from printer using ZPL II commands

Resolution of the printer in use: 200 DPI

Use in Monochrome Printing Mode

Turn on a checkbox when you replacing from a printer using ZPL II commands.  
Turn off when using a printer driver for the CW-C4000 Series.

Adjustment

Vertical positioning: -1.5 %

Horizontal positioning: -1.5 %

Font replacement Setting...

Font width: 100 %

Fix character code table Character code table not selected

Default settings

Apply settings Close Help

If you do not adjust the font width, proceed to step 5.

## 4 Adjust the font width.

First set this to "100%", and then change it after checking actual print results.

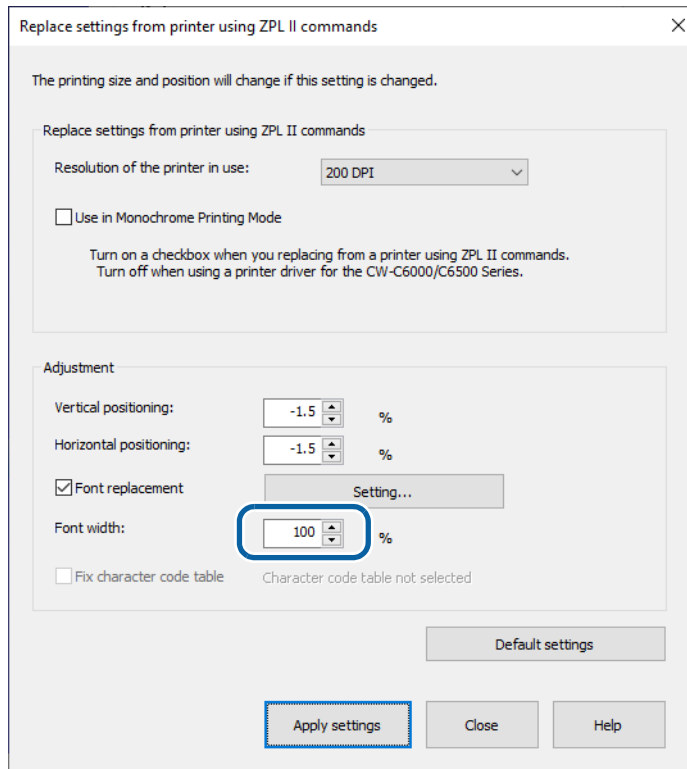

## 5 Click [Apply settings].

The settings are sent and set to the printer.

---

## Printing

Let the printer print under conditions where the printer is actually used, then check the print results.

## Utilizing Templates

If you have used templates with a monochrome thermal printer, you can register the template to CW-C4000 Series and use the templates from your application that directly controls ZPL II commands.

For details, see ["Changing Printer Settings and Replacing Printer" on page 324](#).

Since the ESC/Label commands and ZPL II commands are different in supported range and template file extension, you need to change some commands in accordance with the ESC/Label command specifications. For more details about the ESC/Label command specifications, refer to the "ESC/Label Command Reference Guide".

The procedure is as follows.

### 1 Register the image. ( Page 199)

Register the image to the printer.

### 2 Register the template. ( Page 200)

Register the template to the printer.

If you use template files created by using the ZPL II commands, change the file extension so that the file is supported by the ESC/Label commands. In addition to that, delete commands that are not supported by the ESC/Label commands.

### 3 Link the template and the image. ( Page 204)

Configure the settings to link the template and the image.

### 4 Set the resolution. ( Page 218)

Select [Advanced settings] from the [Detailed settings] menus, then select [Replace settings from printer using ZPL II commands:] and set the resolution that is the same as the resolution of the monochrome thermal printer you were using.

### 5 Print the template.

To print labels using template files, change the file extension of the template file specified by the ZPL II commands in the application so that the file is supported by the ESC/Label commands.

The template specified by the ZPL II command in the application, variable information, and the image are combined and printed.

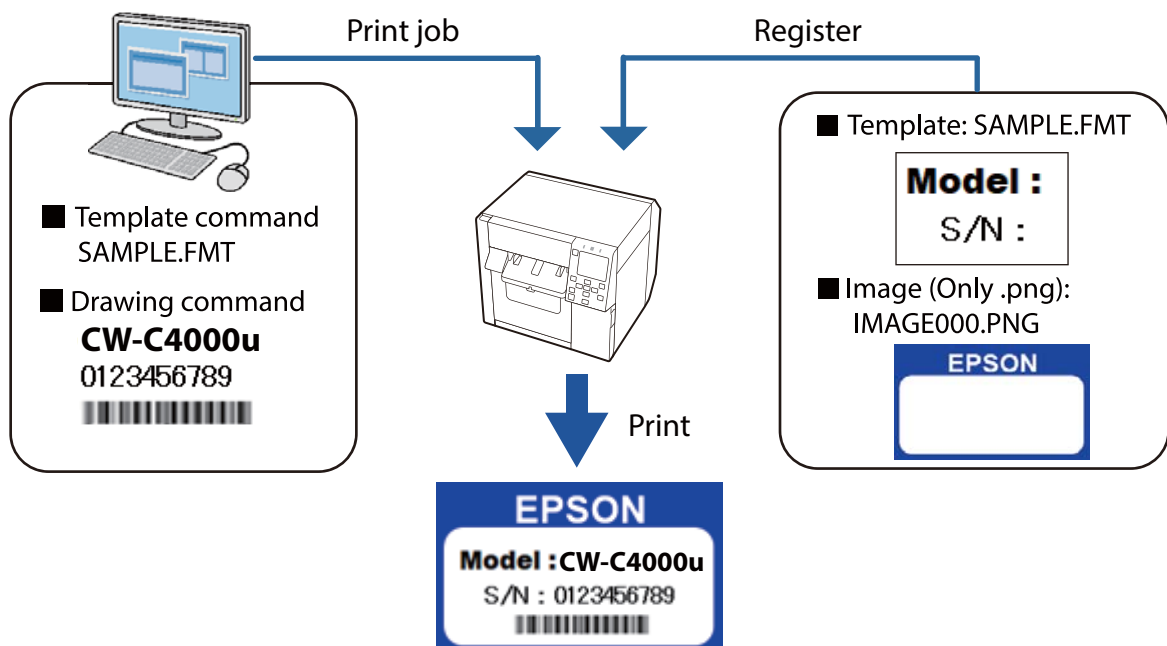

## Software and Manuals

The following pieces of software and manuals are provided.

### Software

Name	Description	Providing Method
Install Navi	Allows you to install the printer driver and other software, and also connect the product with the computer.	CD-ROM*
Printer driver for Windows	Driver to print from Windows applications. The utility (CW-C4000 PrinterSetting) for configuring the printer settings can be started from the driver. For details on how to use the driver, refer to Help or the video.	<ul style="list-style-type: none"> <li>• Web</li> <li>• CD-ROM*</li> </ul>
Printer driver for Mac	Driver to print from Mac applications. For details on how to use the driver, refer to the driver's Help.	Web
Printer driver for Linux	Driver to print from a Linux application.	
EpsonNet Config SE	Tool to acquire or set network settings, such as TCP/IP of the product.	<ul style="list-style-type: none"> <li>• Web</li> <li>• CD-ROM*</li> </ul>
Color Tone Matching Assistant	Assists you to adjust colors of illustrations or letters. You can check how a specific color used in illustrations or letters will look on printouts.	
SAP HVP Plugin	If you use the SAP EH&S WWI HVP system to perform a large amount of printing over the network, the HVP plug-in for EPSON CW-C40x0 can reduce the load on the server and the traffic in the network.	Web
Epson Device Admin	Epson Device Admin is a multifunctional software for managing printers on a network. ( <a href="#">"Epson Device Admin" on page 244</a> )	Web
USB Printer Class Device Replacement Service	When a USB device of the same model is replaced, this tool automatically changes the output destination to a different printer driver without changing the application or OS settings.	Web

\*Depending on country or region, the CD does not come with the printer.

## Manual

Name	Description	Providing Method
Start Here	Guides you through basic setup steps from unpacking to loading paper.	<ul style="list-style-type: none"> <li>• Included in the printer package</li> <li>• Web</li> </ul>
User's Guide	Describes details about the functions and operating procedures of the product, maintenance information, and troubleshooting. Download this guide from the web site or, depending on the country or region, this is included in the supplied CD*. ( <a href="#">"Downloading the Latest Version" on page 3</a> )	<ul style="list-style-type: none"> <li>• Web</li> <li>• CD-ROM*</li> </ul>
CW-C4000 Series Technical Reference Guide (This manual)	Provides information necessary for installing the product, performing daily tasks, and developing a system using the product.	Web
Maintenance box manual	Precautions on handling the maintenance box are described.	<ul style="list-style-type: none"> <li>• Included in the maintenance box package</li> <li>• Web</li> </ul>

\*Depending on country or region, the CD does not come with the printer.

# Appendix

## Product Specifications

Item		Specifications		
Printing method		Serial inkjet, dot matrix method Four-color printing		
Paper feed method		Forward and reverse friction feed		
Cutting type of the auto cutter		Full cut (cuts paper completely)		
Print resolution		300 × 600 dpi, 600 × 600 dpi 600 × 1200 dpi, 1200 × 1200 dpi		
Print speed	Print quality setting: Max Speed 300 × 600 dpi (width × height)	Print width	25.4 mm	124 mm/s
			101.6 mm	100 mm/s
	Print quality setting: Speed 600 × 600 dpi (width × height)	Print width	25.4 mm	111 mm/s
			101.6 mm	70 mm/s
	Print quality setting: Normal 600 × 600 dpi (width × height)	Print width	25.4 mm	63 mm/s
			101.6 mm	48 mm/s
	Print quality setting: Quality 600 × 1200 dpi (width × height)	Print width	25.4 mm	27 mm/s
			101.6 mm	18 mm/s
	Print quality setting: Max Quality 1200 × 1200 dpi (width × height)	Print width	25.4 mm	11 mm/s
			101.6 mm	8 mm/s
Interface		Wired LAN	1000BASE-T/100BASE-TX /10BASE-T	
		Wireless LAN	Available by connecting the optional Wireless LAN Unit (OT-WL06).	
		USB	USB2.0 High-Speed	
Weight		Approx. 13 kg		

## Operating Environment

Supported OS	Windows 11 Windows 10 (32 bit/64 bit) Windows 8.1 (32 bit/64 bit) Windows Server 2022 Windows Server 2019 Windows Server 2016 Windows Server 2012 R2 Windows Server 2012 OS X 10.9.5 or later, macOS 10.12 or later
Operation confirmed OS	CentOS 7 (x86_64) Ubuntu 20.04 (x86_64)
Computer	The following computer that runs one of the above operating systems must be supported. PC/AT compatible machine
CPU	A computer that has Pentium 4 2 GHz or higher processor is recommended.
Memory	1 GB or more is recommended.
HDD	At least 250 MB is required.



- The above requirements may not satisfy the minimum system requirements of the supported operating systems. In that case, satisfy the minimum system requirements of the operating system.
- Epson has confirmed the operation of the above OS distributions and versions. Since there are many distributions and versions of Linux, Epson does not guarantee operation of any particular distribution or version. For OS versions and distributions other than those listed above, you need to check the operation by yourself.

## Paper Specifications

The paper that can be used with this printer are as follows.

Use the paper that is supported by the black ink you are using. If you use paper that is not supported by the black ink you are using, ink smear, bleeding, blurring, or faint print may occur.

### Paper Forms

Paper Forms	Page
Roll Continuous Paper	<a href="#">Page 346</a>
Roll Continuous Paper (Black Mark)	<a href="#">Page 346</a>
Fanfold Continuous Paper (Black Mark)	<a href="#">Page 347</a>
Roll Full-page Label	<a href="#">Page 348</a>
Roll Die-cut Label (Gap)	<a href="#">Page 349</a>
Roll Die-cut Label (Black Mark)	<a href="#">Page 349</a>
Fanfold Die-cut Label (Black Mark)	<a href="#">Page 351</a>

### Paper Types

Paper Type	When using Matte Ink	When using Gloss Ink
Plain Paper	✓	-
Matte Paper	✓	✓
Texture Paper	✓	-
Synthetic	✓	✓
Glossy paper	-	✓
Glossy Film	-	✓
High Glossy Paper	-	✓





- If you use paper that does not satisfy the required specifications, it may cause paper jams or lead to a drop of paper feed accuracy, barcode readability, and print quality.
- If the end edge of roll paper is pasted or taped to the core, the printer will fail to detect the end of the paper resulting in wasting multiple labels on the roll paper.
- If you are using synthetic labels with backing sheet made of paper, or labels with polyethylene laminated backing sheet, paper curl may occur depending on storage and usage environmental conditions. Because the degree of expansion and contraction due to heat and moisture varies between the plastic materials, such as the synthetic and polyethylene, and the paper materials. If you use the curled paper, the paper may be rubbed against the print head causing ink smear on printouts or paper jams.
- Do not use paper sheets connected to each other with pieces of tape or other material. If you use the connected paper, the seams may cause false detection, or the paper may be rubbed against the print head causing ink smear on printouts or paper jams.
- When using matte black ink, if you touch paper surface immediately after printing, ink may adhere to your fingers.
- If labels less than 10 mm in length are automatically cut, they may stay near the fixed blade and be difficult to remove.
- The printer may not be able to detect the paper correctly depending on the paper material and the condition of the black marks. Please verify the paper well before using it.

## Paper Shape/Form/Size

### Roll Continuous Paper (with or without Black Mark)

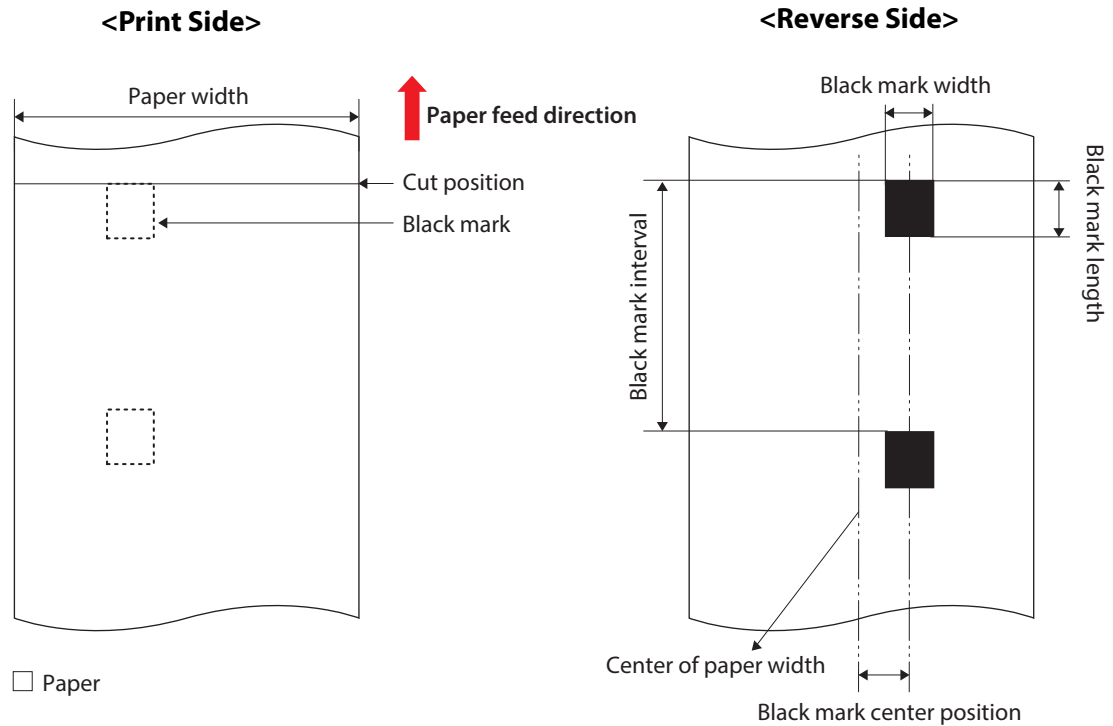

Item	Specifications	
	Continuous Paper	Continuous Paper (Black Mark)
Paper Type	Plain paper, Matte paper, Glossy paper	
Paper width	25.4 to 108 mm	
Black mark position	-	See the above figure
Black mark width	-	13 mm or more
Black mark length	-	At least 4 mm, With 4 mm or more of space around the mark
Black mark center position	-	8.5 +/- 1 mm
Black mark interval	-	8 to 406.4 mm
Paper thickness	0.084 to 0.131 mm	
Roll core outer diameter	44.1 mm or more	
Roll paper outer diameter	Up to 101.6 mm	
Winding direction	The side to be printed must face outward	
Holes and cutouts	Paper with holes or cutouts cannot be used	



Since the black mark detector is not located at the center of the paper width, black marks on both sides can be detected no matter which edge of the paper is printed from.

## Fanfold Continuous Paper (Black Mark)

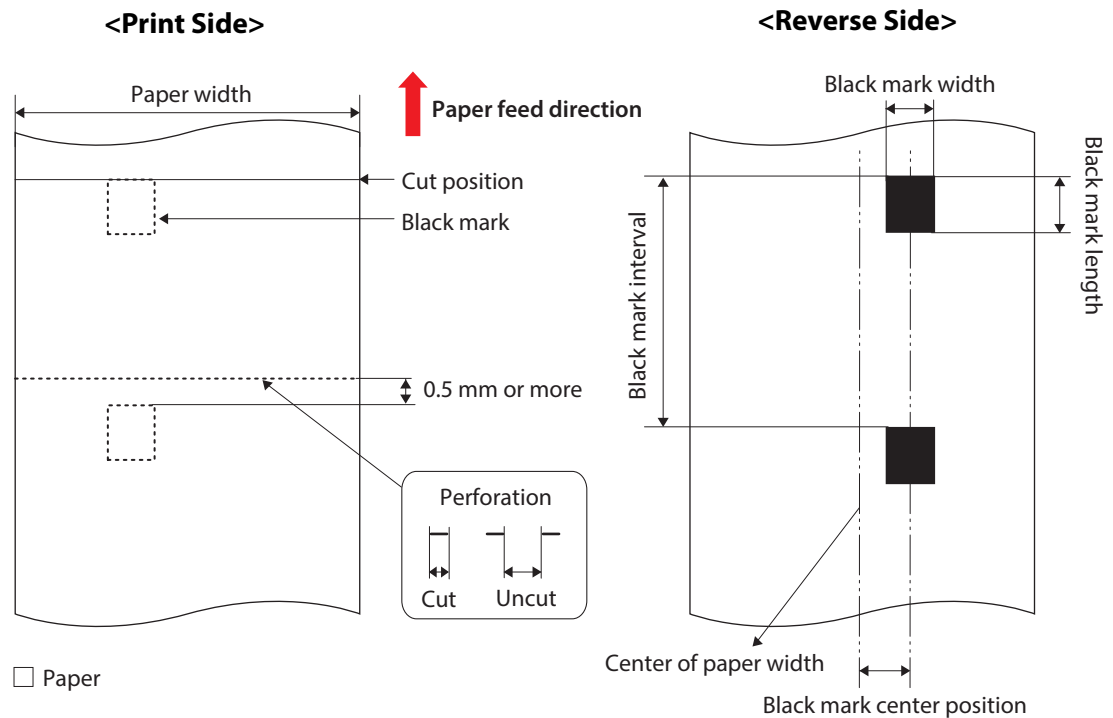

Item	Specifications
Paper Type	Plain paper, Matte paper, Glossy paper
Paper width	50 to 108 mm
Black mark position	See the above figure. At least 0.5 mm away from the perforation
Black mark width	13 mm or more
Black mark length	At least 4 mm, With 4 mm or more of space around the mark
Black mark center position	8.5 +/- 1 mm
Black mark interval	8 to 304.8 mm
Paper thickness	0.119 to 0.131 mm
Perforation interval	152.4 to 304.8 mm
Number of folds	500 or less
Perforation form	3 to 5 mm of slit length with 1 mm interval * There should be no slits at both side edges of paper
Holes and cutouts	Paper with holes or cutouts cannot be used



- Auto cutting on the perforation lines will generate scraps of paper that may cause problems. Also, auto cutting ahead of the perforation line may cause problems when feeding paper. Therefore, perform auto cutting when paper is fed at least 0.5 to 1 mm away from the perforation line.
- Since the black mark detector is not located at the center of the paper width, black marks on both sides can be detected no matter which edge of the paper is printed from.

## Roll Full-page Label

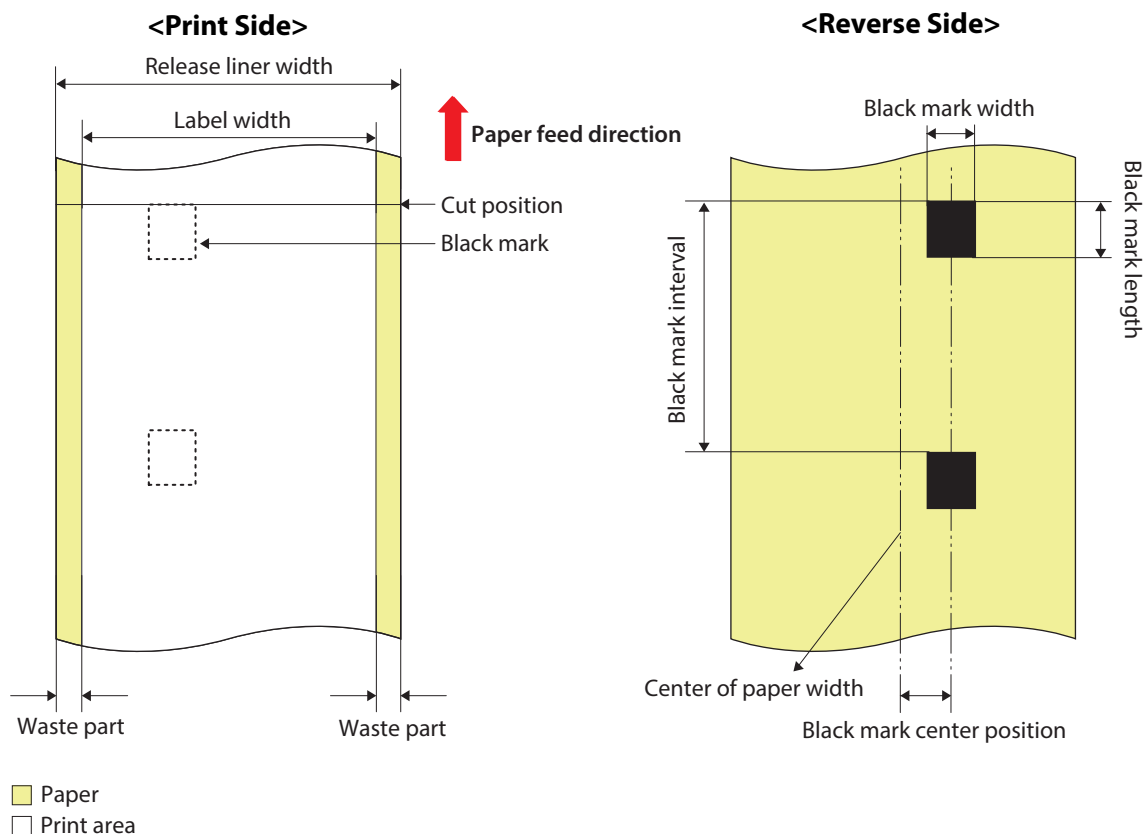

Item	Specifications	
	Without black marks	With black marks
Paper Type	Plain paper, Matte paper, Synthetic paper, Glossy paper, Glossy film, High glossy paper, Texture paper	
Release liner width	25.4 to 112 mm	
Label width	21.4 to 108 mm	
Waste part on the left and right	2 +/- 0.5 mm	
Black mark position	-	See the above figure
Black mark width	-	13 mm or more
Black mark length	-	At least 4 mm, With 4 mm or more of space around the mark
Black mark center position	-	8.5 +/- 1 mm
Black mark interval	-	8 to 406.4 mm
Paper thickness	0.159 to 0.240 mm	
Roll core outer diameter	44.1 mm or more	
Roll paper outer diameter	Up to 101.6 mm	
Winding direction	The side to be printed must face outward	
Holes and cutouts	Paper with holes or cutouts cannot be used	



- To prevent adhesive from adhering to the roll paper supply unit, use label paper from which the left and right wasted parts are removed.
- Since the black mark detector is not located at the center of the paper width, black marks on both sides can be detected no matter which edge of the paper is printed from.

## Roll Die-cut Label (Gap/Black Mark)

### □ Paper without waste parts

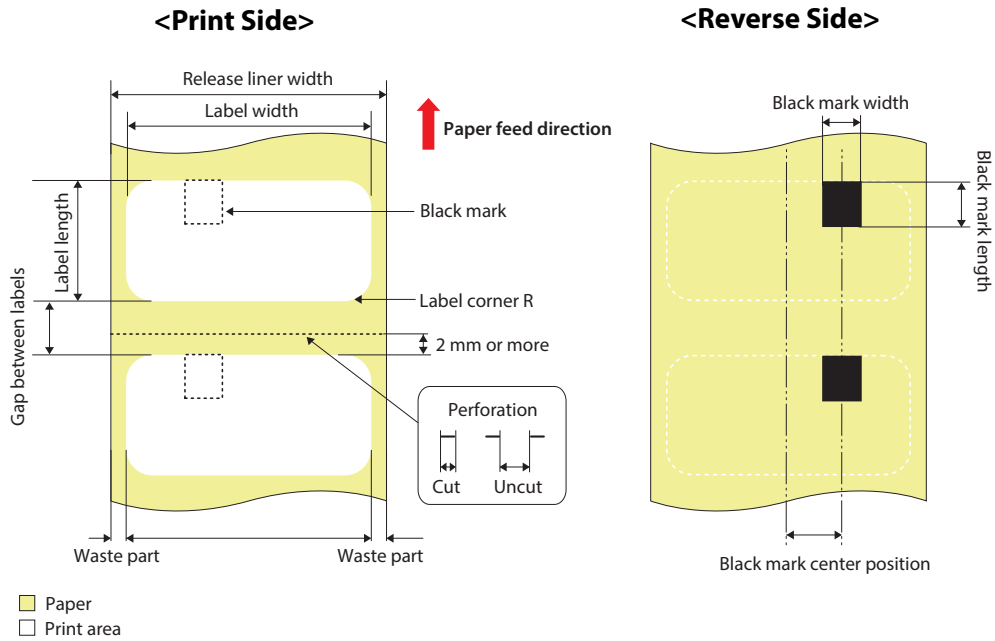

### □ Paper without waste parts on the left and right edges (die-cut label with black marks)

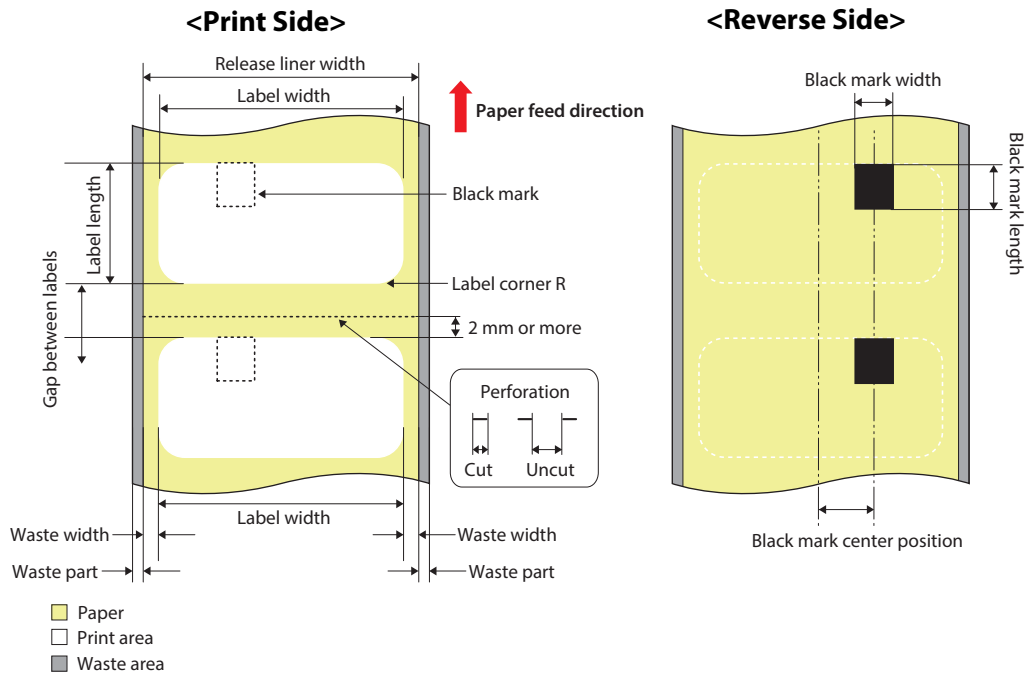

Item	Specifications	
	Die-cut label (Gap)	Die-cut label (Black Mark)
Paper Type	Plain paper, Matte paper, Synthetic paper, Glossy paper, Glossy film, High glossy paper, Texture paper	
Release liner width	25.4 to 112 mm	
Label width	21.4 to 108 mm	
Label length	8 to 406.4 mm	

Item	Specifications	
	Die-cut label (Gap)	Die-cut label (Black Mark)
Gap between labels	2 to 6 mm	
Waste part on the left and right	2 +/- 0.5 mm	
Waste width	-	1.5 mm or more
Label corner R	1.5 mm or less	
Black mark position	-	See the above figure. Leading edge of the mark should be aligned with that of the label
Black mark width	-	13 mm or more
Black mark length	-	At least 4 mm, With 4 mm or more of space around the mark
Black mark center position	-	8.5 +/- 1 mm
Black mark interval	-	10 to 412.4 mm
Paper thickness	0.159 to 0.240 mm	
Roll core outer diameter	<ul style="list-style-type: none"> <li>• 44.1 mm or more (plain paper, matte paper, or synthetic paper)</li> <li>• 56.8 mm or more (paper types other than above)</li> </ul>	
Roll paper outer diameter	Up to 101.6 mm	
Winding direction	The side to be printed must face outward	
Perforation form	3 to 5 mm of slit length with 1 mm interval * There should be no slits at both side edges of paper	
Holes and cutouts	Paper with holes or cutouts cannot be used	



- Auto cutting on the perforation lines will generate scraps of paper that may cause problems. Also, auto cutting ahead of the perforation line may cause problems when feeding paper. Therefore, perform auto cutting when paper is fed at least 0.5 to 1 mm away from the perforation line.
- Place the black mark at least 2 mm away from the perforation.
- Do not use paper whose gap between labels is outside the specification, as it may cause a paper jam.
- Since the black mark detector is not located at the center of the paper width, black marks on both sides can be detected no matter which edge of the paper is printed from.
- Depending on the shape, paper thickness, and hardness of the die-cut label, the label may peel off from the backing inside the product. If you wish to use die-cut labels other than those specified, please contact qualified service personnel in advance.

### Fanfold Die-cut Label (Black Mark)

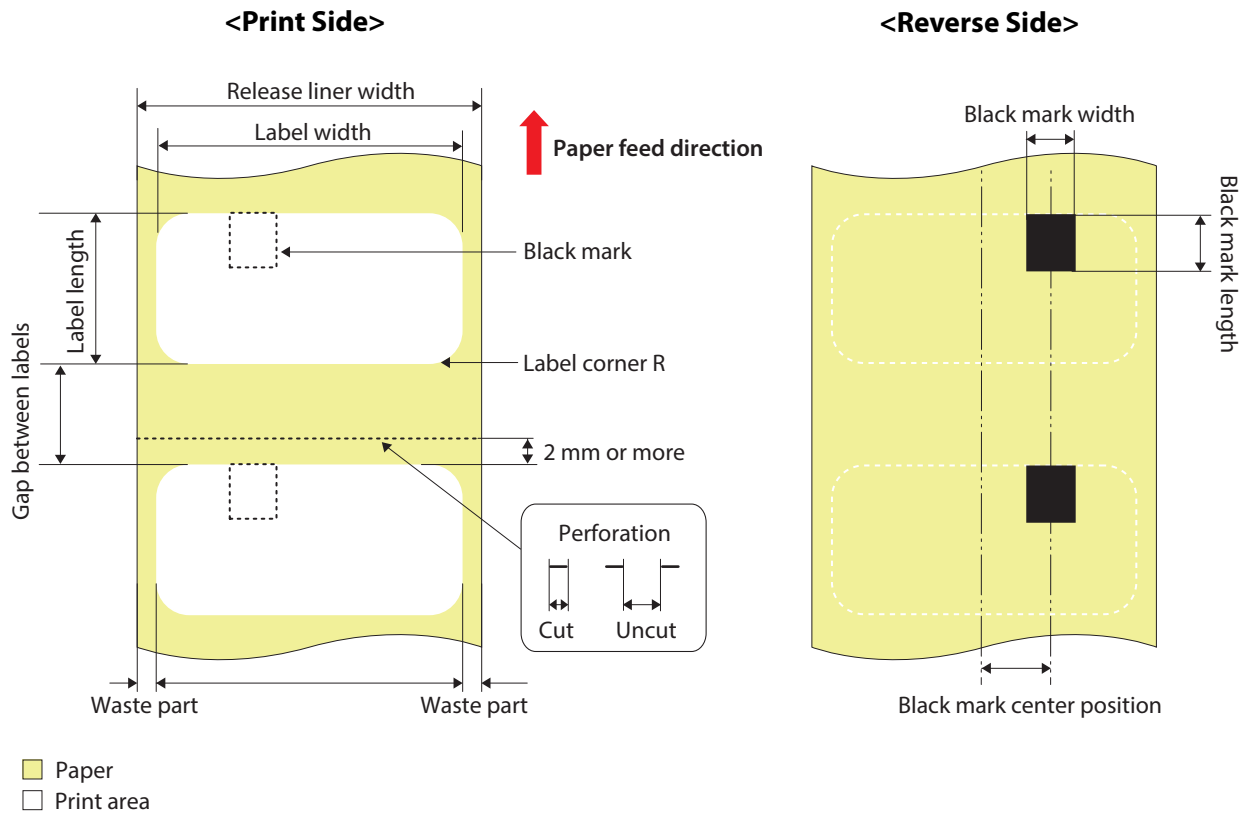

Item	Specifications
Paper Type	Plain paper, Matte paper, Synthetic paper, Glossy paper, Glossy film, High glossy paper, Texture paper
Release liner width	50 to 112 mm
Label width	46 to 108 mm
Label length	8 to 301.8 mm
Gap between labels	2 to 6 mm
Waste part on the left and right	2 +/- 0.5 mm
Waste width	1.5 mm or more
Label corner R	1.5 mm or less
Black mark position	See the above figure. Leading edge of the mark should be aligned with that of the label
Black mark width	13 mm or more
Black mark length	At least 4 mm, With 4 mm or more of space around the mark
Black mark center position	8.5 +/- 1 mm
Black mark interval	10 to 304.8 mm
Paper thickness	0.161 to 0.240 mm
Perforation interval	152.4 to 304.8 mm
Number of folds	500 or less
Perforation form	3 to 5 mm of slit length with 1 mm interval * There should be no slits at both side edges of paper
Holes and cutouts	Paper with holes or cutouts cannot be used



- Auto cutting on the perforation lines will generate scraps of paper that may cause problems. Also, auto cutting ahead of the perforation line may cause problems when feeding paper. Therefore, perform auto cutting when paper is fed at least 0.5 to 1 mm away from the perforation line.
- Place the black mark at least 2 mm away from the perforation.
- Do not use paper whose gap between labels is outside the specification, as it may cause a paper jam.
- Since the black mark detector is not located at the center of the paper width, black marks on both sides can be detected no matter which edge of the paper is printed from.
- Depending on the shape, paper thickness, and hardness of the die-cut label, the label may peel off from the backing inside the product. If you wish to use die-cut labels other than those specified, please contact qualified service personnel in advance.



## Printable Area

### Continuous Paper

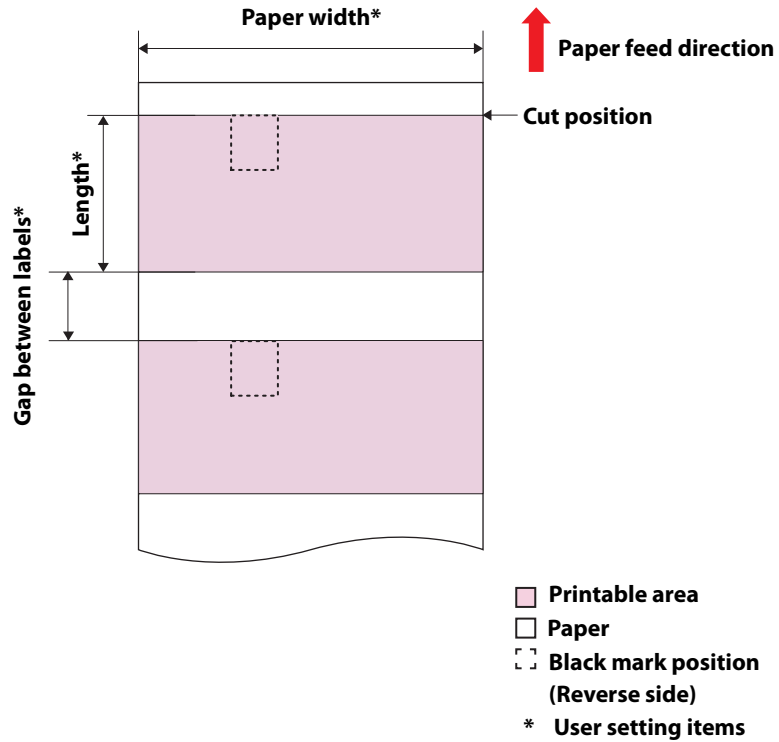

- In the case of borderless printing, the ink may adhere to the label or your hand, causing stains, or to the inside of the printer, causing a malfunction.
- Adding a margin of 1.5 mm or more to the top of the print area may reduce the occurrence of ink smudges and white streaks.

## Die-cut Label (Black Mark), Die-cut Label (without black marks)

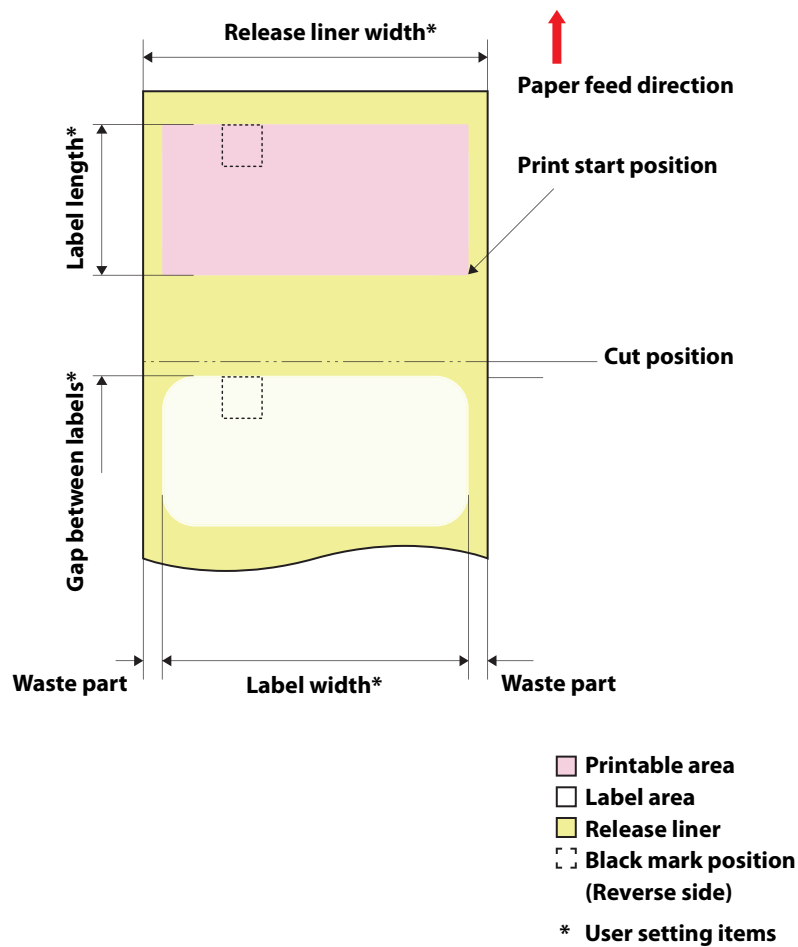

- In the case of borderless printing, the ink may adhere to the label or your hand, causing stains, or to the inside of the printer, causing a malfunction.
- Adding a margin of 1.5 mm or more to the top of the print area may reduce the occurrence of ink smudges and white streaks.

## Full-page Label (Black Mark)

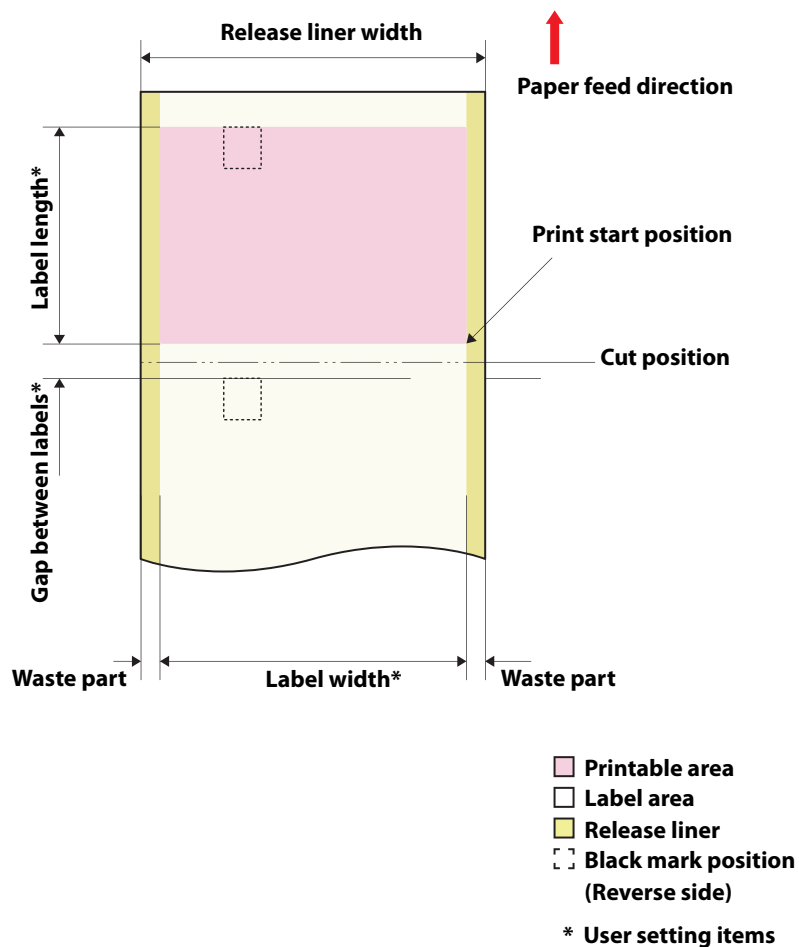

- In the case of borderless printing, the ink may adhere to the label or your hand, causing stains, or to the inside of the printer, causing a malfunction.
- Adding a margin of 1.5 mm or more to the top of the print area may reduce the occurrence of ink smudges and white streaks.

## Full-page Label

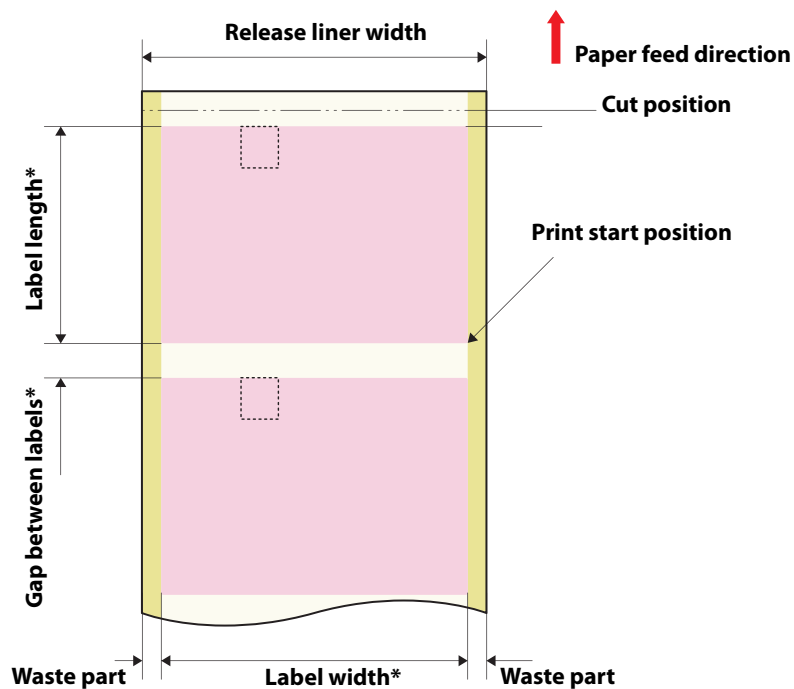

- Printable area
- Label area
- Release liner
- Black mark position (Reverse side)
- \* User setting items



- In the case of borderless printing, the ink may adhere to the label or your hand, causing stains, or to the inside of the printer, causing a malfunction.
- Adding a margin of 1.5 mm or more to the top of the print area may reduce the occurrence of ink smudges and white streaks.

## Paper detection method

Sensor	Label sensor (Transmissive photo interrupter)
	Black mark sensor (Reflective photo interrupter)
Judging method	The label sensor and black mark sensor detect the position of the paper.



- When using die-cut label without black marks, the light transmission rates must be: 40% or higher for the backing paper, and 23% or lower for the labels.
- When using paper with black marks, the black mark reflectance rate must be 10% or lower, and the white reflectance rate is 70% or higher.

## Electrical Specifications

Item		Specifications
Power supply		Dedicated AC adapter (AC ADAPTER, K1, Model number: M248B)
Rated voltage		42 V DC
Rated current		1.38 A
Power consumption*	Operating*	Approx. 28.2 W on average
	Standby	Approx. 2.6 W on average
	Power off	Approx. 0.13 W on average

\* Based on Epson evaluation conditions

## Reliability

Product life	Printer	When any one of the following is reached <ul style="list-style-type: none"> <li>• 5 years</li> <li>• 150 km or 1,500,000 pages</li> <li>• 6,000,000 cycles of carriage movement</li> <li>• 1,500,000 times of valve operation inside the ink path</li> </ul>	
	Auto cutter mechanism (Number of cuts)	Plain roll paper	1,500,000
		Matte roll paper	700,000
		Glossy roll paper	700,000
		Wrist band	200,000
		Die-cut label backing (Plain paper)	1,500,000
		Die-cut label backing (Texture paper)	500,000
		Die-cut label backing (Matte paper)	1,500,000
		Die-cut label backing (Synthetic)	500,000
		Die-cut label backing (Glossy paper)	1,500,000
		Die-cut label backing (Glossy film)	500,000
		Die-cut label backing (High Glossy paper)	1,500,000
		Full-page label (Plain paper)	750,000
		Full-page label (Matte paper)	500,000
		Full-page label (Synthetic)	100,000
		Full-page label (Glossy paper)	300,000
		Full-page label (Glossy film)	100,000
Full-page label (High Glossy paper)	200,000		
Full-page label (Texture paper)	100,000		



- Depending of paper used, the reliability values may differ.
- The cutter reliability may differ if paper is changed to wider paper because it causes differences partially in degree of wear of the cutter blade.

## Environmental Specifications

Item		Specifications	
Temperature/ humidity	Printing	5 to 35°C, 20 to 80% RH without condensation (the blue-colored range in the graph) <div style="text-align: center;"> </div> <p>Outside the above temperature range, the nozzle self-check system may not function properly.</p>	
	Barcode printing	15 to 35°C, 20 to 80% RH without condensation	
	Storage	When packed (ink not charged):	-20 to 60°C, 5 to 85% RH without condensation (Within 120 hours at -20°C or 60°C)
With ink charged:		Gloss black ink	-15 to 40°C (Within 6 months at 0 to 25°C) (Within 1 month at 40°C)
		Matte black ink	-10 to 40°C (Within 6 months at 0 to 25°C) (Within 1 month at 40°C)
Elevation		0 to 3000 m	
Noise		Approx. 58 dB Based on Epson evaluation conditions.	

## Overall Dimensions

Item	Specifications
Height	285 mm
Width	310 mm
Depth	283 mm

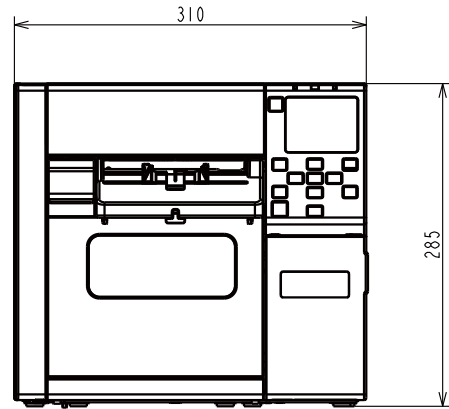
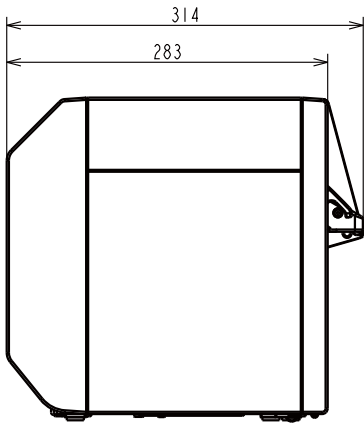

Unit: mm

### With the paper tray installed

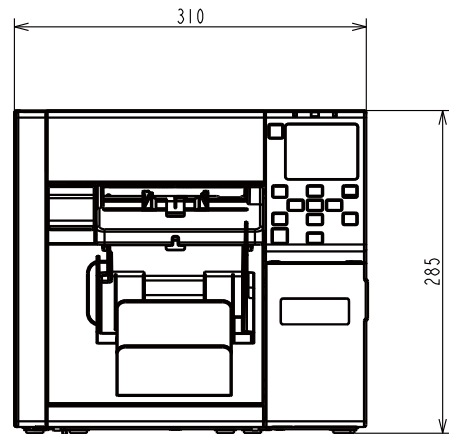
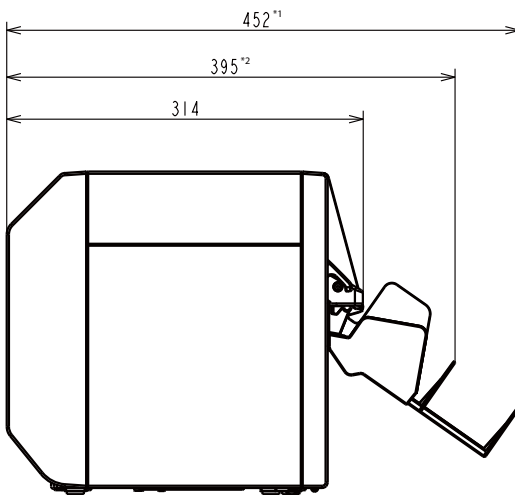

Unit: mm

\*1: When the paper tray is extended

\*2: When the paper tray is retracted



## Consumables Specifications

### Ink Cartridges

Model number	CW-C4000u	SJIC41P-BK, SJIC41P-MK, SJIC41P-C, SJIC41P-M, SJIC41P-Y
	CW-C4000e	SJIC42P-BK, SJIC42P-MK, SJIC42P-C, SJIC42P-M, SJIC42P-Y
	CW-C4010	SJIC42P-BK, SJIC42P-MK, SJIC42P-C, SJIC42P-M, SJIC42P-Y
	CW-C4020	SJIC43P-BK, SJIC43P-MK, SJIC43P-C, SJIC43P-M, SJIC43P-Y
	CW-C4030	SJIC44P-BK, SJIC44P-MK, SJIC44P-C, SJIC44P-M, SJIC44P-Y
	CW-C4040	SJIC45P-BK, SJIC45P-MK, SJIC45P-C, SJIC45P-M, SJIC45P-Y
	CW-C4050	SJIC46P-BK, SJIC46P-MK, SJIC46P-C, SJIC46P-M, SJIC46P-Y
Type	4 individual color cartridges	
Ink colors	Black (gloss black (BK), matte black (MK)), cyan (C), magenta (M), yellow (Y)	
Ink type	Pigmented ink	
Expiration date	6 months after installation in the printer, 3 years from the production date including the period of use	
Storage temperature	Transporting (without unpacking)	-20 to 60°C (within 5 days when 60°C)
	Storage (without unpacking)	-20 to 40°C (within 1 month when 40°C)
	Installed	-20 to 40°C (within 1 month when 40°C)

### Maintenance Box

Model number	SJMB4000	
Type	Maintenance box with integrated waste ink absorbing material	
Storage temperature	Transporting (without unpacking)	-20 to 60°C (within 5 days when 60°C)
	Storage (without unpacking)	-20 to 40°C (within 1 month when 40°C)
	Installed	-20 to 40°C (within 1 month when 40°C)

## Optional Products

### OT-PT40

The OT-PT40 is a paper tray that allows you to temporarily collect printed labels.

The OT-PT40 can store the paper of the following sizes.

Maximum paper size: 105 x 148 mm (width x length)

Minimum paper size: 76 x 54 mm (width x length)



- In the case of roll paper, the paper is curled so if multiple labels or sheets are printed and ejected, they may overflow the OT-PT40.
- Depending on the printer model, OT-PT40 comes with the printer.

Follow the steps below to install the OT-PT40.

- 1 Attach the OT-PT40 to the hooks on the bottom of the paper ejection guides.**

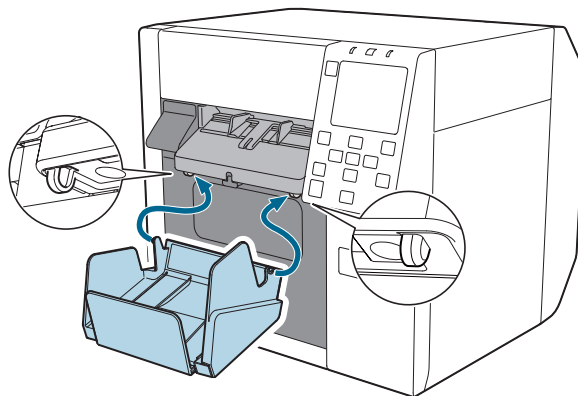

- 2 Pull the lever at the bottom right of the OT-PT40 to release the lock.**

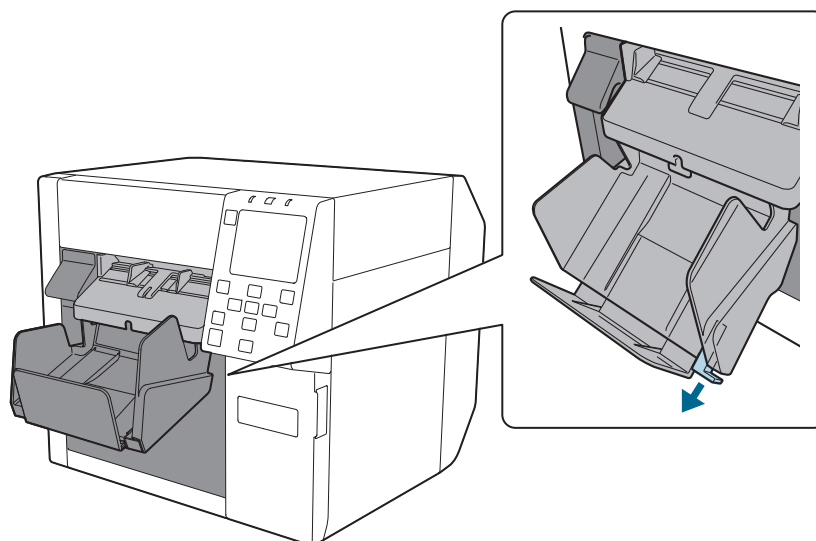

- 3** Extend the tray until the paper length indication matches with the length of your paper.

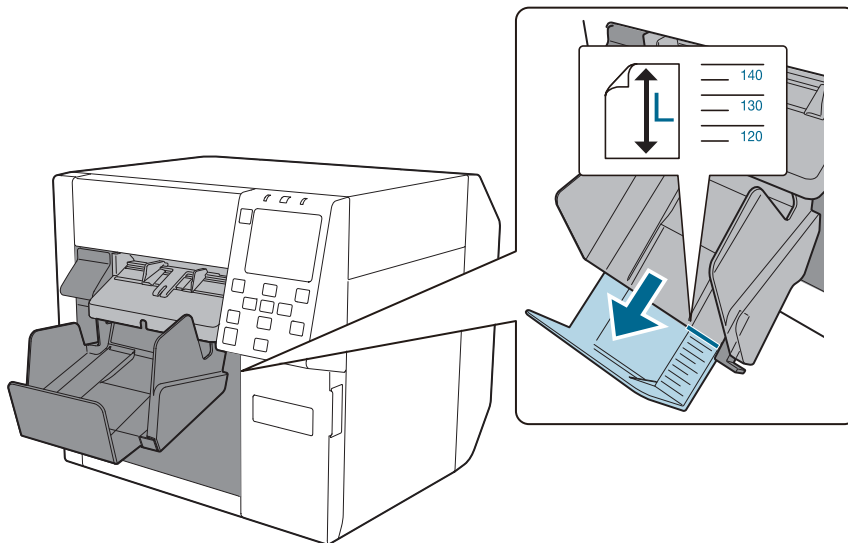

- 4** Push in lever at the bottom right of the tray to lock it in place.

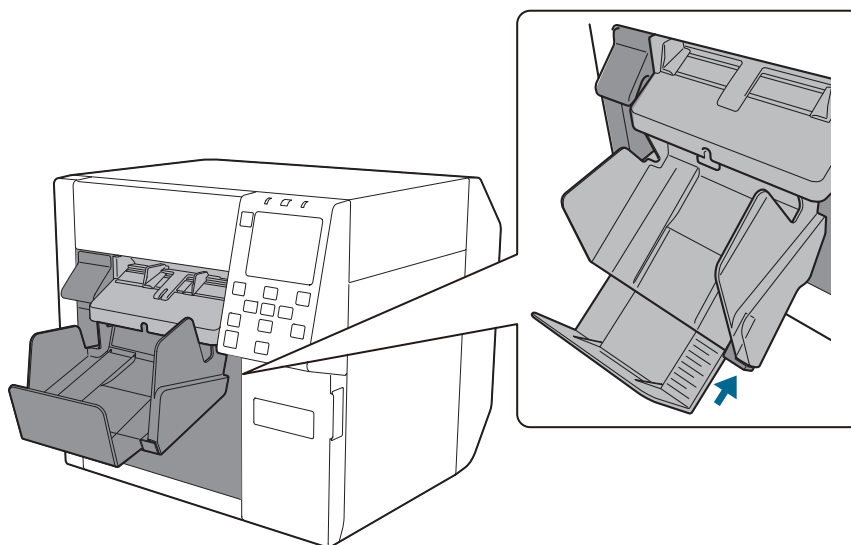

**OT-CU40**

This option is to replace the auto cutter when it has exceeded its service life and is unable to cut.



- The service life of the auto cutter varies depending on the media to be cut. For details, see "[Reliability](#)" on page 358.
- Read the instruction manual included with the option to ensure safe and proper use.
- For details about the replacement method, see the manuals posted at the following URLs.  
[https://support.epson.net/p\\_doc/969/](https://support.epson.net/p_doc/969/)

## Downloading Printer Driver, Utilities, and Manuals

The latest versions of the printer driver, utilities, and manuals can be downloaded from the following URLs.

For customers in North America, go to the following web site:

[https://support.epson.net/p\\_doc/96a/](https://support.epson.net/p_doc/96a/)

For customers in other countries and regions, go to the following web site:

<https://www.epson-biz.com/>

## Label Print Applications

Some commercially available label print applications offer a printer driver for this printer allowing you to use the printer easily from the applications. By using the printer driver, you can make the printer settings and use the printer functions.

When you use the printer driver, you do not need to use the Epson printer driver.

The label print applications that offer a printer driver for this printer are listed below.

- BarTender
- NiceLabel
- CODESOFT

### How to Get Software

BarTender

<https://www.bartendersoftware.com/>

NiceLabel

<https://www.nicelabel.com/>

CODESOFT

<https://www.teklynx.com/>

## For Inquiries

If you have any technical questions about this printer, or if any problems occur, please contact us with the following information.



- Contents of technical questions must be about our printers only. For those about products of Microsoft Corporation or other companies, please contact them.
- If any problems occur, check whether there is any physical cause (such as connection or power problems) before contacting us.

- Type of inquiry: Problem / Question
- Date:
- Your company:
- Department:
- Your name:
- Phone/Fax/Email:
- Computer information:
  - Manufacturer
  - CPU
- OS (with Service Pack information):
- Model name of the printer:
- Printer driver: Installed (OS driver or Epson driver) / Not installed
- Connection type: USB / Ethernet / MS shared (Client / Server)
- Firewall: OS standard / Personal (Product name/Ver.) / None
- Your application information:
  - Windows service operation / Normal EXE operation
- EPSON application status: EpsonNet WebManager / EpsonNet Log Browser / Epson Monitoring Tool / EpsonNet Simple Viewer / EpsonNet SDK for Windows / Printer Setting / Other (Application name)
- Phenomenon of the problem (or content of the question):
- System configuration: Hardware configuration such as computer and network, and Software module configuration
- Procedure of reproduction of the problem: Operation procedure, functional procedure, function and argument value to reproduce
- Reproducibility of the problem: Yes (    out of    times) / No