

# CW-C6000 Series

# CW-C6500 Series

## Technical Reference Guide

---

### **Product Overview**

Describes features for the product.

### **Setup**

Describes setup and installation of the product.

### **Handling**

Describes how to handle the product.

### **Information for Application Development**

Describes how to control the printer and necessary information when you develop applications.

### **Appendix**

Describes specifications of the product.

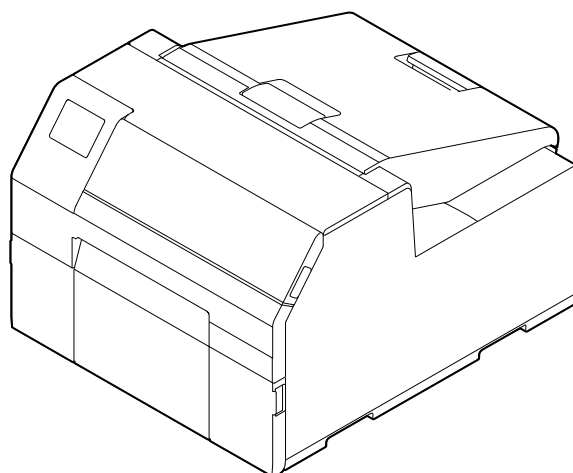
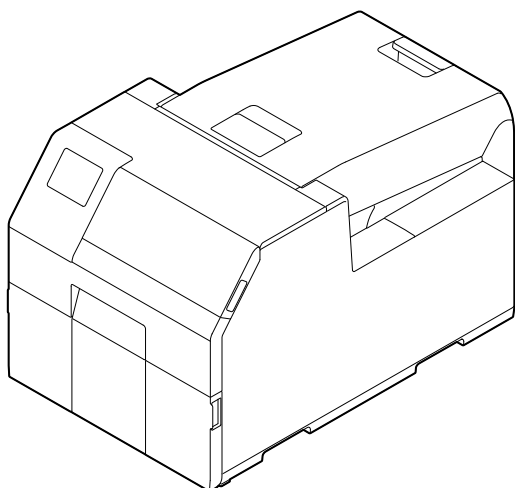

## Cautions

- All rights reserved. No part of this publication may be reproduced, stored in a retrieval system, or transmitted in any form or by any means, electronic, mechanical, photocopying, recording, or otherwise, without the prior written permission of Seiko Epson Corporation.
- The content of this manual is subject to change without notice. Please contact us for the latest information.
- While every precaution has been taken in the preparation of this manual, Seiko Epson Corporation assumes no responsibility for errors or omissions.
- Neither is any liability assumed for damages resulting from the use of the information contained herein.
- Neither Seiko Epson Corporation nor its affiliates shall be liable to the purchaser of this product or third parties for damages, losses, costs, or expenses incurred by purchaser or third parties as a result of: accident, misuse, or abuse of this product or unauthorized modifications, repairs, or alterations to this product, or (excluding the U.S.) failure to strictly comply with Seiko Epson Corporation's operating and maintenance instructions.
- Seiko Epson Corporation shall not be liable for any damages or problems arising from the use of any options or any consumable products other than those designated as Genuine Epson Products or Epson Approved Products by Seiko Epson Corporation.

## Trademarks

Microsoft, Windows are trademarks of the Microsoft group of companies.

Apple, Mac, mac OS, OS X, and ColorSync are trademarks of Apple Inc., registered in the U.S. and other countries.

Zebra Technologies Corporation and ZPL II are the registered trademarks or trademarks of Zebra Technologies Corporation.

Intel®, Celeron®, and Pentium® are trademarks of Intel Corporation in the U.S. and/or other countries.

Adobe, the Adobe logo, Acrobat, Adobe PDF Print Engine, the Adobe PDF Print Engine logo, Illustrator, Photoshop, PostScript and Reader are either registered trademarks or trademarks of Adobe in the United States and/or other countries.

QR Code is a registered trademark of DENSO WAVE INCORPORATED in Japan and other countries.

BarTender® is registered trademark of Seagull Scientific, Inc. in the United States and other countries.

CODESOFT is registered trademarks or trademarks of TEKLYNX International.

This product bundles Dell BSAFE™ software developed by Dell Inc. in the United States.

Copyright© 2021 Dell Inc. All rights reserved.

BSAFE is a trademark or registered trademark of Dell Inc. in the United States and other countries.

All other trademarks are the property of their respective owners and used for identification purpose only.

©Seiko Epson Corporation 2019–2026

# Before Use

This chapter describes information you should know before using the product.

## Manuals for This Product

### Paper manual

### Start Here



Guides you through basic setup steps from unpacking to loading paper.

### Manual viewable with PC

### User's Guide



Describes details about the functions and operating procedures of the product, maintenance information, and troubleshooting.

### Manual viewable with PC

### CW-C6000 Series/CW-C6500 Series Technical Reference Guide (This manual)



Provides information necessary for installing the product, performing daily tasks, and developing a system using the product.

### Manual viewable with PC

### Online Video Manual



Provides videos that show you operating procedures and troubleshooting information. Access the videos from the following URL.

<[https://support.epson.net/p\\_doc/790/](https://support.epson.net/p_doc/790/)>

The contents of videos are subject to change without notice.

---

## Downloading the Latest Version

The latest versions of the printer driver, utilities, and manuals can be downloaded from the following URLs.

For customers in North America, go to the following web site:

<https://www.epson.com/support/>

For customers in other countries and regions, go to the following web site:

<https://epson.sn>



## Symbols Used in This Guide

The following symbols are used in this guide to indicate important information.

---



### Symbols for Safety

The symbols shown below are used in this manual in order to ensure safety and proper use of this product and to prevent danger to you and other persons, and property damage. Be sure that you completely understand their meanings before reading this manual.

 <b>WARNING</b>	Handling the product improperly by ignoring this symbol can lead to death or serious injury.
 <b>CAUTION</b>	Handling the product improperly by ignoring this symbol can lead to injury and property damage.

---

### Symbols for General Information

 <b>IMPORTANT</b>	Indicates information with which you must comply when using the product. Mishandling due to ignoring this information may cause the product to fail or malfunction.
	Indicates supplementary explanations and information you should know.

## Safety Precautions

To ensure safe use of the product, be sure to read this manual and the other instruction manuals supplied with the product before use. Store this manual in a safe place so that you can resolve any unclear points regarding the product at any time.

## Cautions on Installation



Do not block the air vents of the product. (["Rear" on page 21](#))  
Doing so can result in heat accumulated in the product causing a fire.  
Do not cover the product with a cloth or install it in a poorly-ventilated location.  
Furthermore, ensure there is the installation space specified in the manual.



- Do not install/store the product in an unstable location or in a location subject to vibration from other devices. The product may fall or collapse, causing breakage and possible injury.
- Do not install the product in a location exposed to oily smoke or dust, or in a humid location. Doing so may cause electric shock or fire.
- When lifting the product, perform the work with the correct posture. Lifting the product with an inappropriate posture may cause injury.
- Because the product is heavy, do not attempt to carry the product by one person. When unpacking or moving the product, make sure to carry the product by at least two persons. See below for details on the mass of this product. (["Product Specifications" on page 358](#))
- Do not install the product at a location exposed to strong light such as direct sun rays. Doing so may result in printing failure due to malfunction of the detectors.
- If the printer has charged matte black ink and is more likely to be exposed to a temperature of -10 or lower degrees C (14°F), make sure to discharge ink before turning the printer off. Otherwise, the print head may be damaged due to freezing. (["Transporting or Storing the Printer at -10°C \(14°F\) \(With Matte Black Ink Installed\)" on page 312](#))

## Cautions on Handling



- Do not use the product in a location with volatile substances such as alcohol or paint thinner present, or near fire. Doing so may cause electric shock or fire.
- Shut down the product immediately if it produces smoke, a strange odor, or unusual noise. If you go on using the product, it may result in electric shock or fire. If an abnormality occurs, immediately turn off the power and remove the plug from the outlet, and then contact qualified service personnel for advice.
- Shut down the product immediately if a foreign object or water or other liquid gets inside the product. If you go on using the product, it may result in electric shock or fire. Immediately turn off the power and remove the plug from the outlet, and then contact qualified service personnel for advice.
- Do not disassemble the areas other than those mentioned in this manual.
- Never attempt to repair the product yourself as doing so is dangerous.
- Do not use the product in a location where inflammable gas, explosive gas, etc. is present in the atmosphere. Furthermore, do not use aerosol sprayers containing flammable gas inside or around the product. Doing so may cause fire.
- Do not connect cables in ways other than those mentioned in this manual. Doing so may cause fire. It may also damage the other connected devices.
- Do not touch the areas inside the product other than those mentioned in this manual. Doing so may cause electric shock or burns.
- Do not insert metal or flammable materials, or allow them to fall into the product. Doing so may cause electric shock or fire.
- If the screen of the printer is damaged, handle the liquid crystal inside it very carefully. Should any of the following situations arise, take emergency measures.
  - \* When any part gets onto your skin, wipe off the deposit, and wash the area properly with soap and water.
  - \* When any part gets into your eyes, flush them with clean water for at least 15 minutes, and thereafter, consult with a doctor.
  - \* When a part gets into your mouth, immediately consult with a doctor.



- Do not allow anyone to stand or place heavy objects on top of the product. In particular, be careful in the case of a household with children. The product may fall or collapse, causing breakage and possible injury.
- Install the cables and optional products in the proper direction according to the proper procedures. If they are installed improperly, it may result in fire or injury. Follow the instructions in this manual to install them properly.
- Before moving the product, shut down and unplug the product, and make sure that all the cables are disconnected. Failure to do so may damage a cable, causing electric shock or fire.
- Do not store or transport the product while it is tilted, standing, or upside down. Doing so may cause the ink to leak.
- Do not use the printer with the paper cover removed. Doing so will cause the printer to malfunction.



If this product is used in a place where silicon-based gases including siloxane (silicon adhesive, silicon oil, silicon powder, etc.) or malignant gases (nitric acid, hydrogen sulfide, ammonia, chlorine, etc.) are present in the air, contact failure may occur in mechanical contacts such as mechanical switch or DC motor in a short time due to adhesion or oxidation of the insulation film.

## Cautions on Power Supply



### WARNING

- Do not allow dust or other foreign material to adhere to the power plug. Doing so may cause electric shock or fire.
- Do not use a power cord other than that supplied with the product. In addition, do not use the supplied power cord with another device. Doing so may cause electric shock or fire.
- Do not use a damaged power cord. Doing so may cause electric shock or fire. Contact qualified service personnel for advice if the power cord is damaged. Furthermore, observe the following points so as not to damage the power cord.
  - \* Do not modify the power cord.
  - \* Do not place heavy objects on the power cord.
  - \* Do not forcibly bend, twist, or pull the power cord.
  - \* Do not lay the power cord near a heating appliance.
- Do not insert or remove the power plug with a wet hand. Doing so may cause electric shock.
- Do not connect many power cords to one outlet. Doing so may cause fire. Supply power directly from a power outlet.
- Regularly disconnect the power plug from the outlet and clean the base of the prongs and between the prongs. Leaving the power plug connected to the outlet for a long period of time may cause dust to accumulate on the base of the power plug prongs, resulting in a short and fire.
- Hold the plug and do not pull the cord when disconnecting the power plug from the outlet. Pulling the cord may damage the cord or deform the plug, causing electric shock or fire.





### CAUTION

To ensure safety, unplug the product before leaving it unused for an extended period.

## Cautions on Ink Cartridges



### CAUTION

- The ink cartridges that can be used differ depending on the model number of the product. Use ink cartridges suitable for the model number of your printer. ("[Ink Cartridges](#)" on page 407)
- Do not touch the IC chip on an ink cartridge. Doing so may result in normal operation and printing becoming no longer possible.
- The product uses ink cartridges equipped with IC chips to manage the amount of ink used and other information so ink cartridges are usable even if they are removed and reinstalled. However, if an ink cartridge with not much ink remaining is removed and reinstalled, it may not be usable. Some ink is consumed each time cartridges are installed because the product automatically checks their reliability.
- If the firmware version of the printer is other than TS05JC, TS06JC, TS26JC, TS19K2, TS25K3, or TS21K5, you are prompted to select black ink type when turning on the printer and installing the ink cartridges for the first time. Once the black ink cartridge is installed and the printer charge the ink, you cannot change the black ink type any more. The printer does not work if you replace the black ink cartridge with a cartridge of different type of black ink.
- Install all ink cartridges. Printing is not possible if even only one ink cartridge is missing.
- Since ink cartridges are designed to stop the operation before ink runs out completely to maintain the quality of the print head, some ink remains in the used ink cartridges.
- All the ink colors are consumed also for the maintenance operations when an ink cartridge is replaced and for print head cleaning.
- Do not turn off the power or open the ink cartridge cover during ink charging (while the  (power) LED lamp is flashing). Opening the cover may cause the ink to be recharged, resulting in more ink being consumed. Also, it may result in normal printing becoming no longer possible.
- Even for monochrome printing, all the ink colors are used in an operation designed to maintain the printing and print head quality.
- Do not disassemble an ink cartridge. Doing so may cause ink to get into eyes or onto skin.
- Do not disassemble or modify an ink cartridge. Doing so may cause printing malfunction.
- Use of old ink cartridges may result in reduced print quality. Use ink cartridges up within six months after opening the packages. The usage period for ink cartridges is printed on the packaging of the individual ink cartridges.
- If ink contacts your skin, eyes, or mouth, take the following actions.
  - \* When ink gets onto your skin, immediately wash the area with soap and water.
  - \* When ink gets into your eyes, immediately flush them with water. Leaving the ink as is may result in bloodshot eyes or mild inflammation. If something is wrong, immediately consult with a doctor.
  - \* When ink gets into your mouth, immediately spit it out and consult with a doctor.
- There may be some ink around the ink supply port on a removed ink cartridge. Take care so that it does not stain the desk or other surface.
- Do not open an ink cartridge package until you are ready to install the ink cartridge in the product.
- Do not shake an ink cartridge too hard. The ink cartridge may leak if you shake it around too much or push the sides strongly.
- Do not allow foreign objects to fall into the cartridge installation section. Doing so may result in normal printing becoming no longer possible. Remove any object that falls into the installation section, taking care not to damage the section.
- When ink is charged the first time (right after purchase), ink is consumed for filling the print head nozzles (ink discharge holes) to get ready for printing. Therefore, the number of the sheets that can be printed may be fewer than for cartridges installed later.
- When the printer is powered off with the  (power) button, the print head is automatically capped to prevent the ink from drying. When you will not use the printer after installing the ink cartridges, be sure to turn the power off with the  (power) button. Do not pull out the power plug or turn off the breaker while the power is on.



- Printing on water-repellent paper such as art paper, which is slow-drying, may cause print stains. Also, if you print on glossy paper, fingerprints may get on the paper or ink may adhere to your fingers when you touch the print surface. Select and use paper that will not cause print stains.
- Store the ink cartridges in a place out of reach of children.
- Epson recommends storing ink cartridges in a cool and dark place.
- If you wish to use ink cartridges that have been stored in a cold place for a long period of time, leave them for at least 3 hours in a place that is at room temperature before use.
- Do not remove the ink cartridges from the product when storing or transporting the product.

## Cautions on the Maintenance Box



- Store in a place out of reach of children. Do not drink any adhered ink.
- Do not disassemble or modify the maintenance box. Doing so may cause ink to get into eyes or onto skin.
- Do not touch the IC chip on the maintenance box.
- If a maintenance box that can still be used has been removed and left detached for a long period of time, do not reuse it.
- Do not peel off the film from the top surface of the maintenance box.
- If ink contacts your skin, eyes, or mouth, take the following actions.
  - \* When ink gets onto your skin, immediately wash the area with soap and water.
  - \* When ink gets into your eyes, immediately flush them with water. Leaving the ink as is may result in bloodshot eyes or mild inflammation. If something is wrong, immediately consult with a doctor.
  - \* When ink gets into your mouth, immediately spit it out and consult with a doctor.
- Do not shake a used maintenance box too hard. The ink may leak from the maintenance box if you swing or shake it too hard.
- Avoid storing the maintenance box under high temperatures or in a frozen state.
- Keep it away from direct sunlight.

## Caution Label

The labels affixed to the product indicate the following cautions.

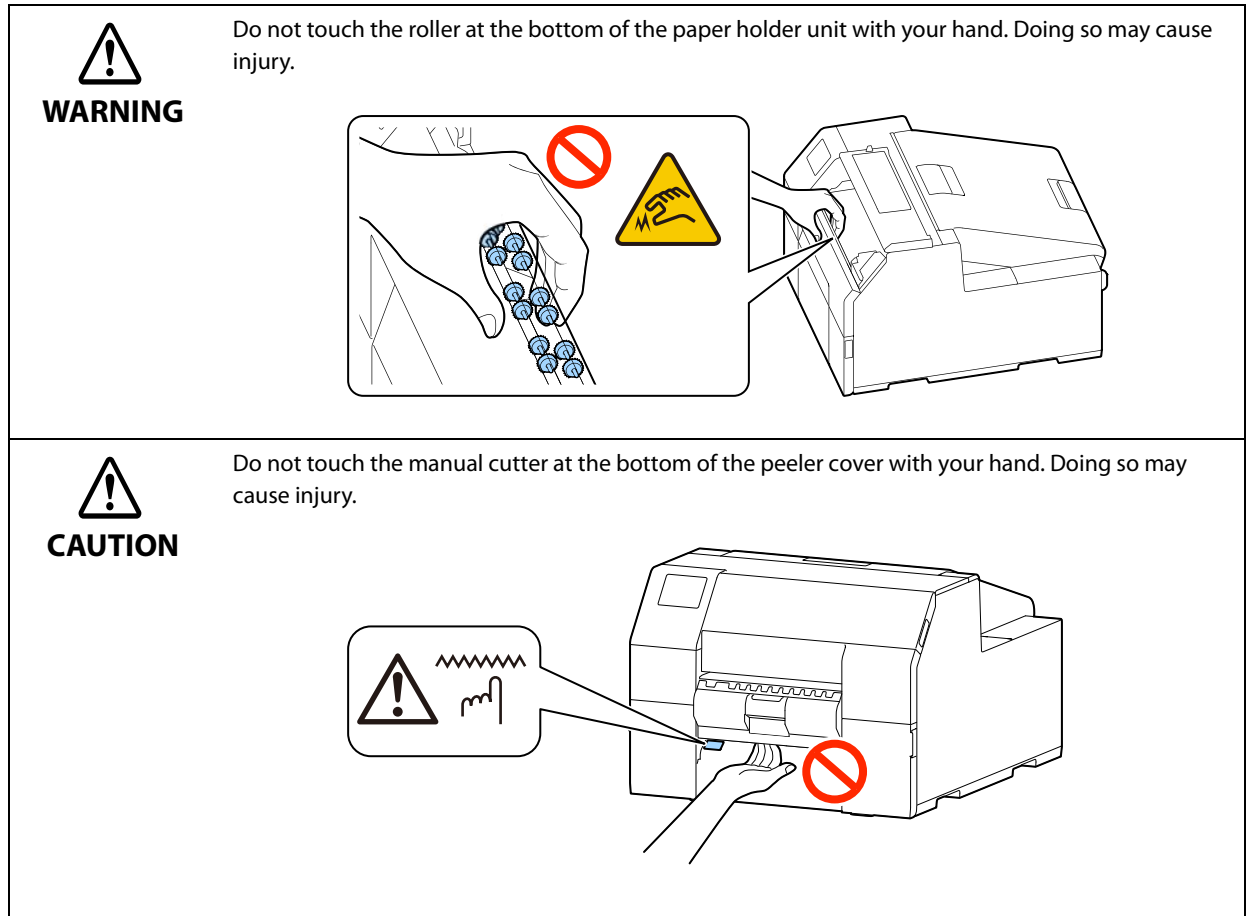

## Restriction of Use

When this product is used for applications requiring high reliability/safety such as transportation devices related to aviation, rail, marine, automotive etc.; disaster prevention devices; various safety devices etc.; or functional/precision devices etc., you should use this product only after giving consideration to including fail-safes and redundancies into your design to maintain safety and total system reliability. This product is not intended for use in applications requiring an extremely high level of reliability and safety, such as in aerospace instruments, main communication equipment, nuclear power control equipment, or medical equipment, etc. Please make your own judgment on this product's suitability after a full evaluation.

## About This Manual

### Aim of the Manual

This manual is intended to provide information required for developing, designing, and installing a system, and for developing and designing printer applications for developers.

### Manual Content

This manual consists of the following chapters.

Chapter 1	<a href="#">Product Overview</a>
Chapter 2	<a href="#">Setup</a>
Chapter 3	<a href="#">Handling</a>
Chapter 4	<a href="#">Information for Application Development</a>
Appendix	<a href="#">Appendix</a>

### Screenshots

Unless otherwise noted, Windows 10 screenshots are used in this manual. Depending on the printer model and OS version that you use, the screenshots may differ from actual Windows screens.

Depending on version of the printer driver and utility you are using, screens shown in this manual may slightly differ from actual screens.

### Illustrations

Unless otherwise noted, illustrations of CW-C6500 Series are used in this manual. They may look slightly different from your printer.

# Contents

■ <b>Before Use</b> .....	<b>3</b>
Manuals for This Product.....	3
Symbols Used in This Guide .....	4
Safety Precautions .....	5
Cautions on Installation.....	5
Cautions on Handling .....	6
Cautions on Power Supply .....	7
Cautions on Ink Cartridges .....	8
Cautions on the Maintenance Box.....	9
Caution Label .....	10
■ <b>Restriction of Use</b> .....	<b>11</b>
■ <b>About This Manual</b> .....	<b>11</b>
Aim of the Manual .....	11
Manual Content.....	11
Screenshots.....	11
Illustrations.....	11
■ <b>Contents</b> .....	<b>12</b>

---

## ***Product Overview***..... **18**

■ <b>About Models of this Product</b> .....	<b>18</b>
Auto cutter model .....	18
Peeler model.....	18
Gloss Black Ink/Matte Black Ink .....	19
About the Version of the Printer Driver and Utility.....	19
■ <b>Part Names and Functions</b> .....	<b>20</b>
Front .....	20
Rear .....	21
Inside.....	23
Spindle and Flange.....	24
Operation Panel.....	25
■ <b>Nozzle Verification Technology</b> .....	<b>28</b>
Nozzle Verification Technology Settings .....	28
Dot Substitution (Supplemental Printing) Function.....	30
■ <b>Periodic Auto Cleaning</b> .....	<b>31</b>
Setting Time to Start the Periodic Auto Cleaning .....	31
Execution of the Periodic Auto Cleaning .....	31
Examples of the Time Setting to Avoid Interrupting Printing Operation.....	31
■ <b>Checking the Printer Status</b> .....	<b>32</b>
Printing the Status Sheet .....	32
Printing the Network Connection Check Report.....	33
Checking the Status of Consumables.....	34

<b>Setup .....</b>	<b>35</b>
■ <b>Unpacking .....</b>	<b>35</b>
■ <b>Removing the Protective Materials .....</b>	<b>36</b>
■ <b>Installing the Printer .....</b>	<b>37</b>
■ <b>Connecting the Power Cable .....</b>	<b>38</b>
■ <b>Turning On/Off .....</b>	<b>39</b>
Turning the Power On .....	39
Turning the Power Off .....	39
■ <b>Setting Language and Date/Time .....</b>	<b>40</b>
■ <b>Selecting Black Ink Type .....</b>	<b>40</b>
■ <b>Installing the Ink Cartridges .....</b>	<b>41</b>
Replacing the Ink Cartridges .....	42
■ <b>Installing the Maintenance Box .....</b>	<b>44</b>
Replacing the Maintenance Box .....	44
■ <b>Installing the Printer Driver and Connecting to a Computer .....</b>	<b>47</b>
■ <b>How to Configure the Network Settings .....</b>	<b>48</b>
■ <b>Media Settings .....</b>	<b>49</b>
■ <b>Opening the Paper Cover .....</b>	<b>50</b>
Opening the Cover using the Lever in the Front .....	50
Opening the Cover using the Lever in the Back .....	50
■ <b>Loading Paper .....</b>	<b>51</b>
How to Load Paper (Auto Cutter Model - Supply from Inside) .....	52
How to Load Paper (Auto Cutter Model - Supply from Outside) .....	56
How to Load Paper (Peeler Model - Supply from Inside) .....	60
How to Remove Paper (For the Auto Cutter Model) .....	66
How to Remove Paper (For the Peeler Model) .....	68
How to Eject Paper at Paper End (For the Auto Cutter Model) .....	70
How to Eject Paper at Paper End (For the Peeler Model) .....	71
Feeding Paper into the Printer Manually .....	72
■ <b>Test Print .....</b>	<b>73</b>
Test Print using the Printer Driver .....	74
<b>Handling .....</b>	<b>75</b>
■ <b>Printer Driver for Windows .....</b>	<b>75</b>
Printer Driver .....	75
Printer Driver Screen Configuration .....	76
Media Setting .....	77
Media Source and Media Detection Settings .....	85
User-Defined Paper .....	87
Banner Printing .....	92

Printing Barcodes .....	94
Printing 2D Symbols.....	105
Printing Barcodes / 2D Symbols on .NET Environment .....	113
Favorite Settings.....	115
User Defined Information .....	118
Exporting/Importing Printer Driver Settings .....	118
Starting PrinterSetting from the Printer Driver .....	123
Speeding Up Printing using High Speed Batch Label Printing Function.....	124
Sharing the Printer Driver .....	134
Setting EPSON Status Monitor 3.....	158
Restrictions on Using the Printer Driver.....	164
Printer Driver Isolation .....	165
<b>■ Printer Driver for Mac .....</b>	<b>167</b>
Basic Procedure for Printing .....	167
Customizing the Printer Driver.....	173
Epson Label Printer Utility.....	175
<b>■ Printer Driver for Linux .....</b>	<b>177</b>
Getting the Package (epson-inkjet-printer-cw-c6000c6500) .....	178
Installing the Printer Driver .....	178
Installing Input/Output Modules .....	178
Adding the Printer to the CUPS .....	178
Installing Epson Label Printer Utility for Linux .....	180
Starting Epson Label Printer Utility for Linux.....	180
Exiting Epson Label Printer Utility for Linux.....	181
Uninstalling Printer Driver, Epson Label Printer Utility for Linux .....	181
<b>■ Printing from SAP System .....</b>	<b>183</b>
Methods of Printing from SAP System .....	183
Direct Printing .....	185
Indirect Printing.....	185
High Volume Printing .....	186
<b>■ PrinterSetting (Windows) .....</b>	<b>187</b>
How to Start PrinterSetting .....	188
How to Apply Settings .....	189
Media settings.....	190
Layout settings.....	191
Position adjustment.....	193
Print results adjustment.....	195
Store data in the printer.....	196
Background image settings .....	200
Print head maintenance .....	204
Printer settings.....	205
Print Head Alignment.....	206
Panel settings .....	211
Operating Time Settings.....	213
Nozzle check settings .....	214
Advanced settings .....	215
Initialize printer.....	224
Printer information .....	225
Settings save and restore .....	227
Option .....	228

■ Operation Panel Settings.....	229
■ Web Config .....	243
■ Epson Device Admin.....	245
■ EPSON Cloud Solution PORT.....	246
■ Using Loftware's Loftware Cloud .....	247
Registering a Printer (Web Config) .....	247
Registering a Printer (Epson Device Admin) .....	254
How to Check the Printer Connection Status .....	262
Troubleshooting .....	267
■ Spot Color Settings .....	268
Creating Spot Color Setting File.....	268
Printing using the Spot Color Setting File.....	273
■ Color Correction .....	274
Relationship Between Driver Settings, Color Correction Methods, and Spot Color Settings.....	274
Color Correction Method Options by Model .....	275
Setting on the Printer .....	277
Setting using OS.....	278
Creating an ICC Profile.....	285
None .....	287
■ Printing from the First Label (Auto cutter model only) .....	288
■ Setting Label Size and Paper Layout for Borderless Printing .....	289
Borderless Printing Concepts.....	289
Label Media Settings .....	290
■ Adjusting Sensitivity of the Detectors and Threshold for Detecting Labels .....	291
■ Adjusting Gap Detector .....	292
Adjusting Label Detector for Circle Die-cut Labels (Example).....	293
■ Restricting Operation of the Operation Panel (Lock Setting function) .....	294
Setting an Administrator Password .....	294
Enabling the [Lock Setting] Function .....	295
Changing the Administrator Password .....	295
Resetting the Administrator Password.....	296
■ Cleaning the Printer.....	297
Cleaning the Exterior .....	298
Cleaning the Auto Cutter (Auto Cutter Model Only).....	299
Cleaning the Peeler (Peeler Model Only).....	300
Cleaning the Edge Guides.....	301
Cleaning the Platen .....	302
Cleaning the Paper Feed Roller.....	303
Cleaning the Paper Pressure Roller .....	306
Print Head Cleaning .....	309
Using the Operation Panel.....	310
Using the Printer Driver .....	310
Using the Web Config.....	310
■ Storing the Printer After Ink is Charged .....	311
Preparation for Long-Term Storage .....	311

Transporting or Storing the Printer at -10°C (14°F) (With Matte Black Ink Installed).....	312
For Using the Printer after Long Storage.....	312
<b>■ For Transporting the Printer .....</b>	<b>313</b>
<b>■ Troubleshooting.....</b>	<b>314</b>
A message is displayed on the operation panel.....	314
Print Quality Problems .....	318
Cannot Print .....	321
Network Connection Check Errors.....	324
A message is displayed on the computer screen .....	325
Printing from a computer is impossible or becomes suddenly impossible.....	326
Print Job is Canceled on PC but "Printing" Message on Printer Does Not Disappear.....	328
Error Beep Sound Does Not Stop .....	328
Paper is jammed .....	328

---

## ***Information for Application Development..... 335***

<b>■ How to Control the Printer .....</b>	<b>335</b>
<b>■ Using the Epson Inkjet Label Printer SDK .....</b>	<b>336</b>
Operating Environment.....	336
How to Get Software.....	336
<b>■ Using the ESC/Label Commands.....</b>	<b>337</b>
How to Get Software.....	337
<b>■ Replacing from ZPL II Compatible Monochrome Printer .....</b>	<b>338</b>
Changing from Two-Step Printing to One-Step Printing.....	338
Utilizing Templates .....	355
<b>■ Software and Manuals .....</b>	<b>356</b>

---

## ***Appendix..... 358***

<b>■ Product Specifications .....</b>	<b>358</b>
Relationship Between "Print Resolution" and "Resolution Settings" .....	359
Operating Environment.....	360
Paper Specifications .....	361
Paper detection method .....	396
Electrical Specifications .....	396
Reliability.....	397
Environmental Specifications.....	398
Overall Dimensions .....	399
<b>■ Consumables Specifications .....</b>	<b>407</b>
Ink Cartridges .....	407
Maintenance Box.....	408
<b>■ Option Specifications .....</b>	<b>409</b>
Roll Paper Holder.....	409

---

■ Requirements for External Devices .....	410
Media Source Setting .....	410
Paper Feed Speed .....	410
Paper Tension.....	411
Paper Curl.....	412
Paper Angle for Feeding and Ejecting .....	413
Position of Paper Feeder and Paper Rewinder .....	414
■ Downloading Printer Driver, Utilities, and Manuals.....	415
■ Label Print Applications.....	415
How to Get Software.....	415
■ For Inquiries .....	416

# Product Overview

This chapter describes features of the product.

## About Models of this Product

### Auto cutter model

Features: Equipped with an auto cutter. The paper can be cut either according to the application settings, or with the help of the Cut button on the operation panel.

Model number:

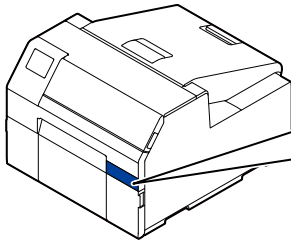

#### **CW-C6000 Series (4-inch model)**

ColorWorks C6000Au, ColorWorks C6000Ae, ColorWorks C6010A, ColorWorks C6020A, ColorWorks C6030A, ColorWorks C6040A, ColorWorks C6050A

#### **CW-C6500 Series (8-inch model)**

ColorWorks C6500Au, ColorWorks C6500Ae, ColorWorks C6510A, ColorWorks C6520A, ColorWorks C6530A, ColorWorks C6540A, ColorWorks C6550A

### Peeler model

Features: Equipped with a peeler mechanism. By passing a backing paper through the peeler, labels are printed being peeled from the backing paper.

Model number:

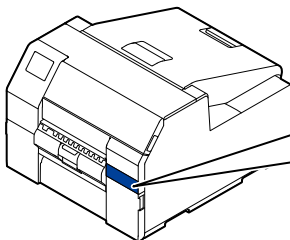

#### **CW-C6000 Series (4-inch model)**

ColorWorks C6000Pu, ColorWorks C6000Pe, ColorWorks C6010P, ColorWorks C6020P, ColorWorks C6030P, ColorWorks C6040P, ColorWorks C6050P

#### **CW-C6500 Series (8-inch model)**

ColorWorks C6500Pu, ColorWorks C6500Pe, ColorWorks C6510P, ColorWorks C6520P, ColorWorks C6530P, ColorWorks C6540P, ColorWorks C6550P

Lateral view (when waiting the printed label to be removed):

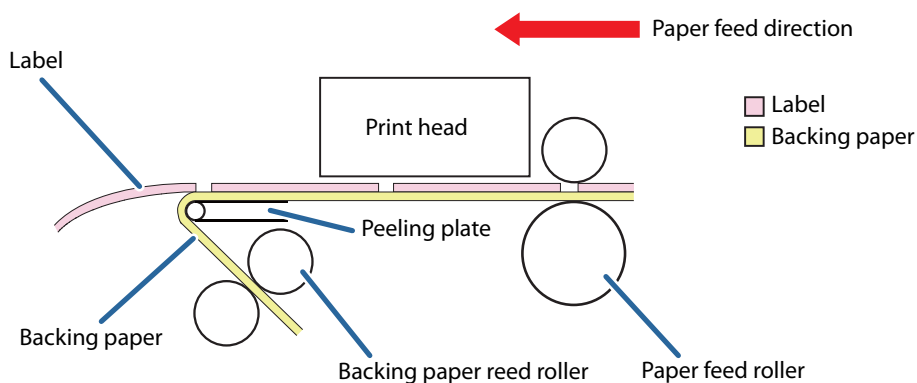

## Gloss Black Ink/Matte Black Ink

If the firmware version of the printer is other than TS05JC, TS06JC, TS26JC, TS19K2, TS25K3, or TS21K5, you can select either gloss black (BK) and matte black (MK) for the type of black ink you want to use. The printer prompts you to select it when you turn on the printer for the first time.



### IMPORTANT

You cannot change the black ink type once you select the black ink type and let the printer charge the ink.

## About the Version of the Printer Driver and Utility

Depending on the firmware version of the printer, available versions of the printer driver and utility vary. Use the combination indicated as "Available (Recommended)" in the table below. In addition, download and use the latest version of firmware.

You can use the combinations indicated as "Available", however, the printer may malfunction or there may be restrictions on some functions.

		Driver/PrinterSetting Version	
		Ver.1.0.0.0 / Ver.1.1.0.0	Versions higher than those in the left column
Printer firmware version	TS05JC, TS06JC, TS26JC, TS19K2, TS25K3, TS21K5	Available	Not available
	Versions higher than those in the above row.	Not available	Available (Recommended)

You can check the version of your printer firmware by using one of the following methods.

- Printing the status sheet ("[Printing the Status Sheet](#)" on page 32)
- Checking on the operation panel ("[Operation Panel Settings](#)" on page 229)

To get the latest version of the printer driver and utility, see "[Downloading Printer Driver, Utilities, and Manuals](#)" on page 415.

## Part Names and Functions

This section describes the main operation parts.

### Front

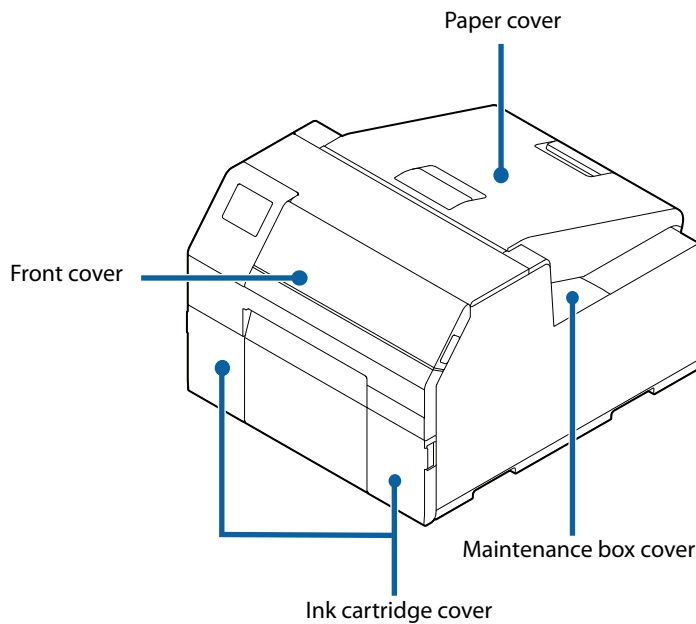

### Peeler model

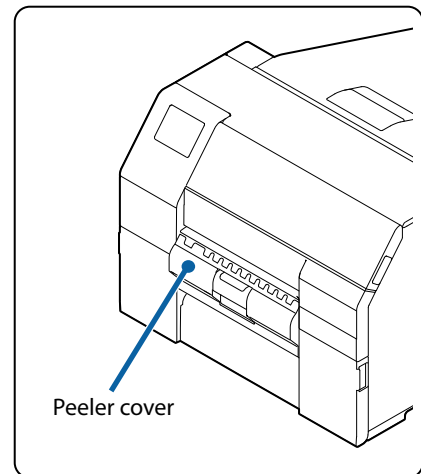

Name	Description
Front cover	Open this cover to remove paper if it is jammed. ("Paper is jammed" on page 328)
Ink cartridge cover	Open this cover to install/replace the ink cartridge. ("Replacing the Ink Cartridges" on page 42)
Maintenance box cover	Open this cover to install/replace the maintenance box. ("Replacing the Maintenance Box" on page 44)
Paper cover	Open this cover to load or replace paper. How to open the paper cover differs depending on whether the paper is to be supplied from the inside or the outside. ("Opening the Paper Cover" on page 50)
Peeler cover (peeler model only)	Open this cover to load paper. By passing a backing paper through the peeler, labels are printed being peeled from the backing paper. The cover is equipped with a label peeling detector, which detects whether a peeled label is remaining at the paper ejection slot or not.

Rear

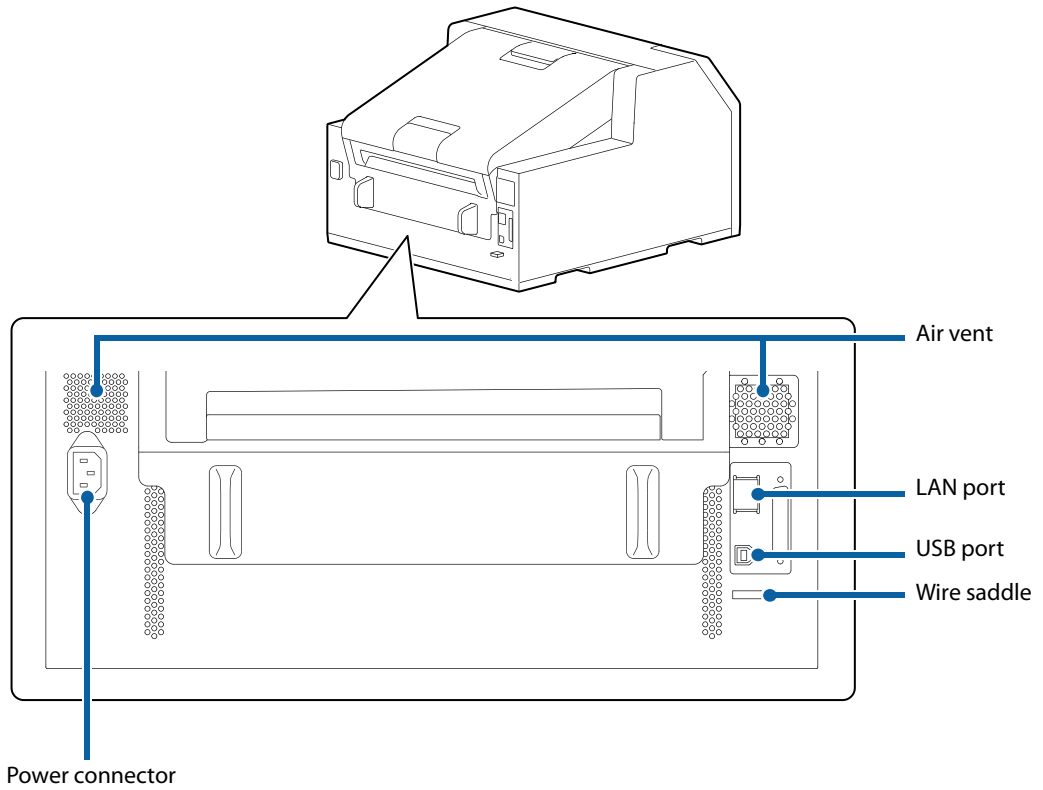

Name	Description
Power connector	Connect the power cable.
Wire saddle	Pass the USB cable through this saddle to prevent disconnection of the cable.
USB port	Connect a USB cable.

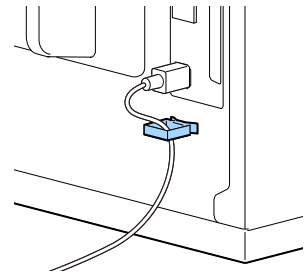

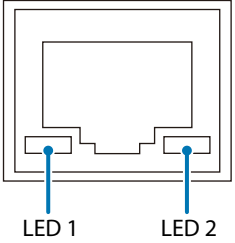
Name	Description																	
LAN port	<p data-bbox="443 297 655 322">Connect a LAN cable.</p> <p data-bbox="443 333 671 358"><b>LED Status Indication</b></p>  <table border="1" data-bbox="448 656 1430 1043"> <thead> <tr> <th data-bbox="448 656 616 707">LED</th> <th data-bbox="616 656 882 707">LED status</th> <th data-bbox="882 656 1430 707">Description</th> </tr> </thead> <tbody> <tr> <td data-bbox="448 707 616 875" rowspan="3">LED1</td> <td data-bbox="616 707 882 763">Lit yellow</td> <td data-bbox="882 707 1430 763">Connecting at one of the speeds</td> </tr> <tr> <td data-bbox="616 763 882 819">Blinking yellow</td> <td data-bbox="882 763 1430 819">Sending/receiving data</td> </tr> <tr> <td data-bbox="616 819 882 875">Off</td> <td data-bbox="882 819 1430 875">Not connected</td> </tr> <tr> <td data-bbox="448 875 616 1043" rowspan="3">LED2</td> <td data-bbox="616 875 882 931">Lit green</td> <td data-bbox="882 875 1430 931">Connecting using 1000BASE-T</td> </tr> <tr> <td data-bbox="616 931 882 987">Lit orange</td> <td data-bbox="882 931 1430 987">Connecting using 100BASE-TX</td> </tr> <tr> <td data-bbox="616 987 882 1043">Off</td> <td data-bbox="882 987 1430 1043">Connecting using 10BASE-T, or not connected</td> </tr> </tbody> </table>	LED	LED status	Description	LED1	Lit yellow	Connecting at one of the speeds	Blinking yellow	Sending/receiving data	Off	Not connected	LED2	Lit green	Connecting using 1000BASE-T	Lit orange	Connecting using 100BASE-TX	Off	Connecting using 10BASE-T, or not connected
LED	LED status	Description																
LED1	Lit yellow	Connecting at one of the speeds																
	Blinking yellow	Sending/receiving data																
	Off	Not connected																
LED2	Lit green	Connecting using 1000BASE-T																
	Lit orange	Connecting using 100BASE-TX																
	Off	Connecting using 10BASE-T, or not connected																
Air vent	<p data-bbox="443 1081 1430 1167">Exhausts heat generated in the printer to prevent the temperature inside the printer from rising. Provide a clearance of 10 cm {3.94"} or more from the area around the air vent to ensure ventilation when installing the printer.</p>																	

## Inside

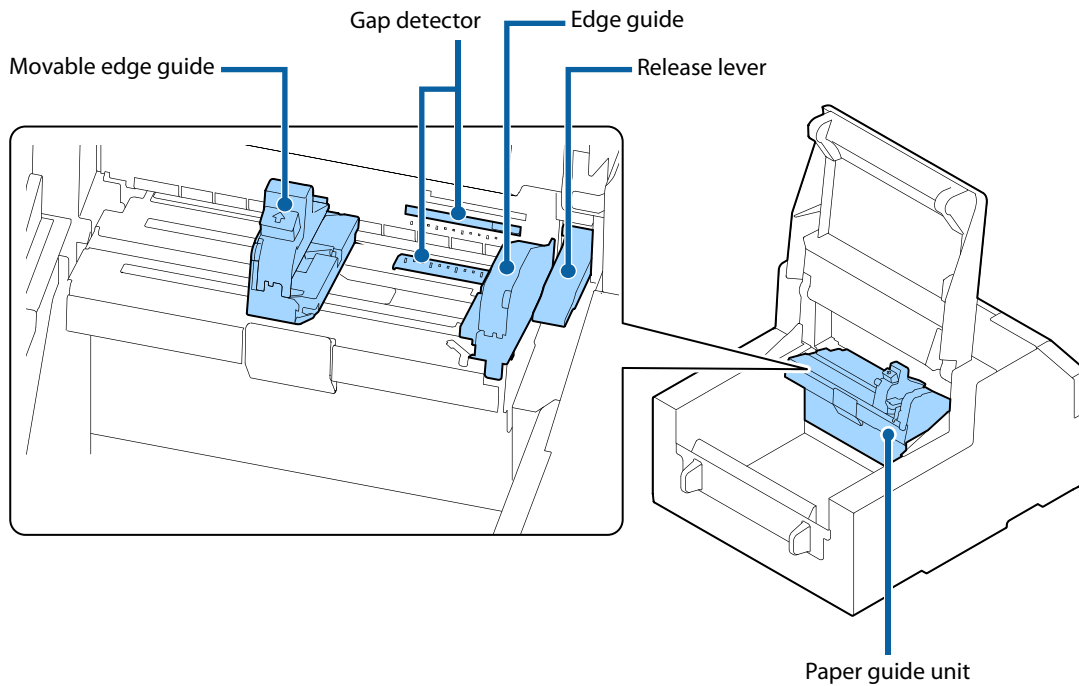

Name	Description
Movable edge guide	Supports paper at the paper width position while the paper is fed into the printer. Squeeze the blue lever to move the edge guide. Adjust them to match the paper width.
Gap detector	You can adjust the position of the gap detector. The adjustment is necessary before printing on odd-shaped labels such as circle or oval. (" <a href="#">Adjusting Gap Detector</a> " on page 292)
Release lever	Use this lever when removing a jammed paper. By moving the lever up, the paper pressure rollers are unlocked and you can remove paper jammed inside the front cover.
Edge guide	Supports paper while the paper is fed into the printer. When loading paper, load the paper along this guide.
Paper guide unit	Move this unit when cleaning the paper feed roller. If you pull the blue lever, the entire unit moves, and you can check the paper feed roller.

## Spindle and Flange

Used to supply the paper from the inside.

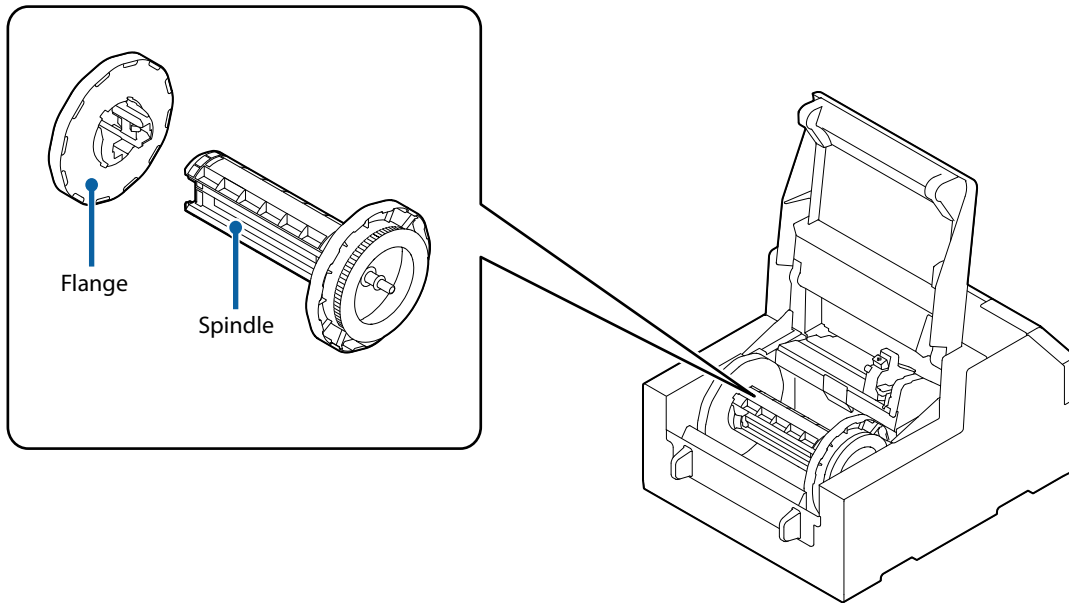

Name	Description
Flange	Attach this to the spindle to fix the roll paper loaded on the spindle. Squeeze the blue lever to attach or remove to/from the spindle.
Spindle	Load roll paper on this spindle.

## Operation Panel

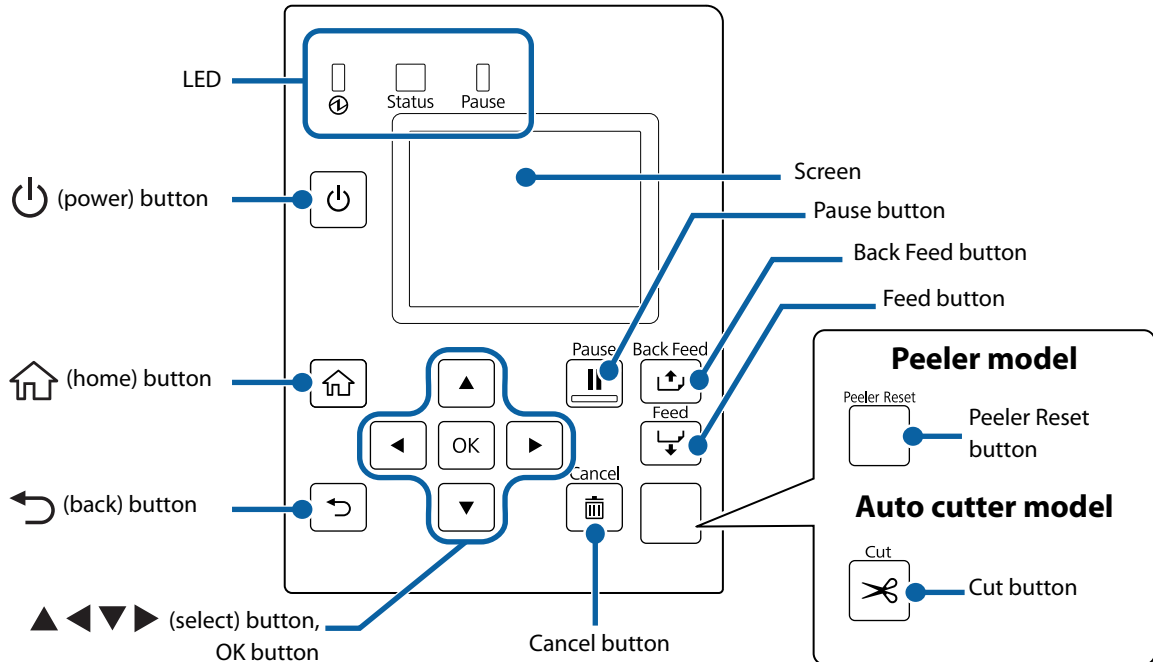

Name	Description
LED	<p>The status of the printer can be checked from the flashing of the LEDs. This allows you to know the cause of an error and how to resolve the problem.</p> <ul style="list-style-type: none"> <li>• (power) LED Stays on while the printer is on. Flashes during printing or charging ink.</li> <li>• Status LED Stays on or flashes while an error or problem is occurring.</li> <li>• Pause LED Stays on or flashes while the printer is paused.</li> </ul>
(power) button	Turns on/off the printer.
(home) button	Displays the Home screen.
(back) button	Use to return to the previous screen.
▲◀▼▶ (select) button, OK button	Use the ▲◀▼▶ keys to select a menu item, and then press the OK button to activate the selected menu or setting.
Cancel button	<p>Use this to cancel printing.</p> <p>To cancel printing, press the [Cancel] button while the printer is paused, and select either the [Next label format] or the [All label formats] on the "Cancel Selection" screen.</p>
Cut button (Auto cutter model only)	Use to cut paper. The paper cannot be cut twice at the same position.
Peeler Reset button (Peeler model only)	Press this button if printing of the next data does not start even after removing printed labels. For details, refer to <a href="#">"Cannot Print" on page 321</a> .

Name	Description
Feed button	Press this briefly to feed paper by one page. Hold down to feed paper continuously.
Back Feed button	Use to replace paper. Hold down this button to feed the paper backward until you can pull the paper out of the printer.
Pause button	<ul style="list-style-type: none"> <li>If pressed during printing The printer pauses after printing of the current page is finished, and the Pause LED lights up. Press it again to resume printing and turn the Pause LED off.</li> <li>If pressed during standby The printer pauses, and the Pause LED lights up. Press it again to return to standby and turn the Pause LED off.</li> <li>If printing paused due to an error Press to release the printer pause and turn the Pause LED off.</li> </ul>
Screen	Status of the printer, menus, and error messages are displayed.

## Home Screen

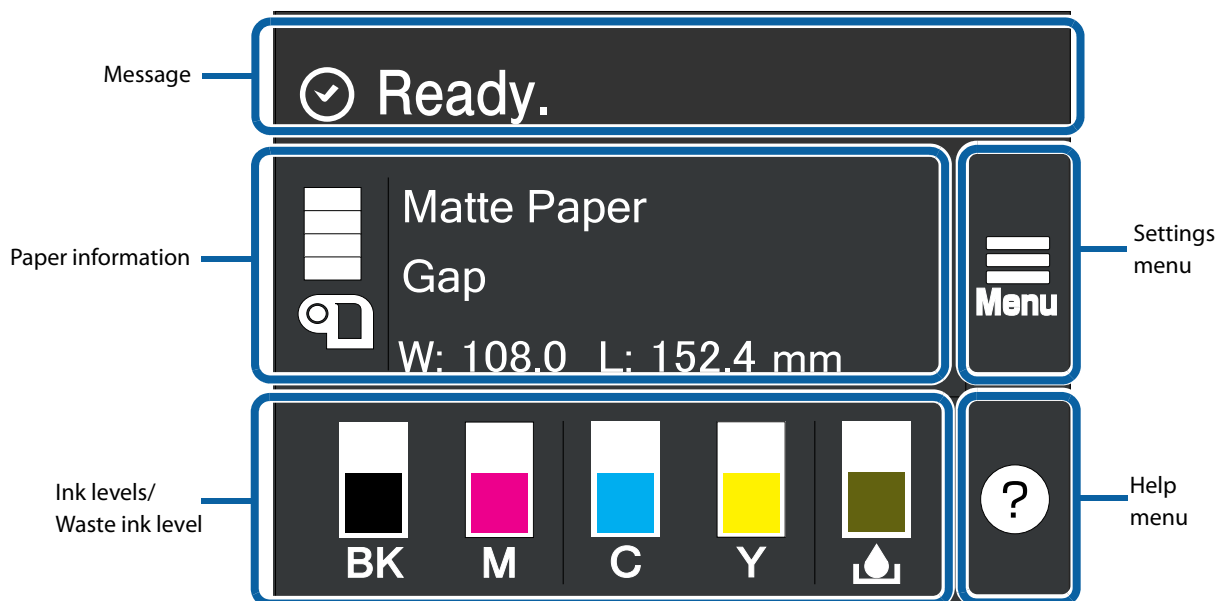

Name	Description
Message	A printer status or an error message is displayed. ( <a href="#">"A message is displayed on the operation panel!"</a> on page 314)
Paper information	The current paper settings are displayed. For a roll paper, approximate remaining paper length of the roll is also displayed. Touch this area to directly access the [Paper Settings] menus.

Name	Description
Ink levels/ Waste ink level	<p>The length of the bars indicate how much ink of each color is remaining, and how much space in the maintenance box is remaining. The shorter the bars are, the lower the ink levels and remaining space are.</p> <p>A [ ! ] mark will appear when the ink cartridge or the maintenance box needs to be replaced soon.</p> <p>A [ x ] mark will appear when the ink cartridge or the maintenance box needs to be replaced.</p> <p>Matte black ink is displayed as "MK".</p>
Help menu button	You can see troubleshooting information and basic operating procedures.
Settings menu button	<p>Allows you to access the maintenance menus, various printer settings, and network settings. Throughout this manual, touching this button is indicated as [Menu].</p> <p>All the settings available from this button are listed in the link below.</p> <p><a href="#">("Operation Panel Settings" on page 229)</a></p>

## Nozzle Verification Technology

The “Nozzle Verification Technology” allows the printer to detect clogging of the print nozzles by self-check. Depending on required print quality, you can enable or disable the “Nozzle Verification Technology” function, set how often to run the self-check, threshold for the check, and whether to run a cleaning after the check. In addition to that, if nozzle clogging is not cleared by the cleaning, the printer carries out supplemental printing using nozzles adjacent to the clogged nozzles.

By using this function, you can prevent sharp decline in the print quality and barcode quality.

### Nozzle Verification Technology Settings



Self nozzle check is run at the following times.

- When the number of printouts has reached the number specified as the detection interval of the auto nozzle check system.
- When the printer is turned on.
- When the front cover or the paper cover is closed after a paper jam.
- When the time specified by the periodic cleaning arrives.  
[\("Periodic Auto Cleaning" on page 31\)](#)

If the “Nozzle Verification Technology” function is enabled, self nozzle check is run at the following time.

- When the number of printouts has reached the number specified as the interval of the self-check.

If the result of self nozzle check exceeds the specified threshold, a head cleaning is run automatically to clear the nozzle clogging. After the cleaning, the self nozzle check is run again. If the result of the check still exceeds the threshold, auto cleaning is also run again.

 <b>CAUTION</b>	<p>This function cannot provide 100% accuracy guarantee for preventing drop in print quality due to nozzle clogging. The printer cannot perfectly detect missing dots and skewed ink drops on printouts.</p>
	<ul style="list-style-type: none"> <li>• The cleaning cleans the entire print head. It does not clean the print head partially for cleaning only the clogged nozzles.</li> <li>• A small amount of ink is consumed for this Nozzle Verification Technology function.</li> <li>• The print head cleaning is run automatically after the self nozzle check when set to do so. Ink is consumed for the head cleaning.</li> </ul>

### Enabling/Disabling the Nozzle Verification Technology

You can enable or disable the Nozzle Verification Technology function.

The factory default is “Enable”.

#### How to Set

Set using the operation panel of the printer, or using PrinterSetting.

See ["Operation Panel Settings" on page 229](#) or ["PrinterSetting \(Windows\)" on page 187](#).

## Setting Auto Nozzle Check Interval

Specify the number of printouts to let the printer run the nozzle check when reached the number. The printer will stop while running the check.

### How to Set

Set using the operation panel of the printer, or using PrinterSetting.

Specify the number in the range of 1 to 13000.

See ["Operation Panel Settings" on page 229](#) or ["PrinterSetting \(Windows\)" on page 187](#).



- The count of printouts is reset when the specified number is reached and nozzle check is performed, and when the printer is turned off.
- The factory default is "500".

## Setting Threshold of Nozzle Clogging

Specify the threshold of nozzle clogging. If the number of detected clogged nozzles exceed the threshold, a message is displayed on the printer's screen. You can set to run an auto head cleaning in such a case. If the number of clogged nozzles is below the threshold, you can use the supplemental printing function.

### How to Set

Set using the operation panel of the printer, or using PrinterSetting.

Specify the number in the range of 0 to 16 nozzles.

See ["Operation Panel Settings" on page 229](#) or ["PrinterSetting \(Windows\)" on page 187](#).



- The number of nozzles is the total of four color (BK (MK), C, M, Y) nozzles.
- The factory default is "6".

## Setting Auto Cleaning after Nozzle Check

You can set to run an auto head cleaning when the number of detected clogged nozzles exceeds the threshold.

When this setting is enabled: A message is displayed on the printer's screen and the cleaning is run automatically when the number of detected clogged nozzles exceeds the threshold.

When this setting is disabled: A message is displayed on the printer's screen when the number of detected clogged nozzles exceeds the threshold, but the cleaning is not run.

### How to Set

Set using the operation panel of the printer, or using PrinterSetting.

The factory default is "Enable".

See ["Operation Panel Settings" on page 229](#) or ["PrinterSetting \(Windows\)" on page 187](#).

## Dot Substitution (Supplemental Printing) Function

The “Dot Substitution” function automatically supplements missing dots caused by clogged nozzles with dots generated by nozzles adjacent to the clogged nozzles. The number of nozzles that can be supplemented is up to 16 nozzles. However, if the clogged nozzles are located next to each other, the supplementation does not work well. If the number of clogged nozzles exceeds 16, supplementation for 16 nozzles is performed without stopping the printing operation.

You cannot use this function if you have disabled the Nozzle Verification Technology function. Enable the Nozzle Verification Technology function to use this function.



- This function cannot perfectly supplement missing dots, so drop in print quality or barcode quality can occur even if this function is used.
- Since the supplementation is performed according to information of clogged nozzles that has been acquired when starting printing, nozzles that get clogged during printing are not supplemented.

### How to Set

Set using the operation panel of the printer, or using PrinterSetting.

The factory default is “Enable”.

See ["Operation Panel Settings" on page 229](#) or ["PrinterSetting \(Windows\)" on page 187](#).

## Periodic Auto Cleaning

Sometimes, the printer runs a periodic cleaning automatically to maintain the print head in good condition. The cleaning takes 3 to 14 minutes, and printing is disabled during the cleaning. To prevent the cleaning from running when you want to print, set the time to start the periodic auto cleaning.

The cleaning will start at the specified time. However, the cleaning is not run if the printer determines that the print head does not need to be cleaned.

Setting the cleaning start time allows you to clean the print head without interrupting printing operation. The default time is "00:00".

### Setting Time to Start the Periodic Auto Cleaning

Set using the operation panel of the printer, or using PrinterSetting.

During the cleaning, printing is disabled. Specify a time when the printer is on but not in use. The time can be set in one-minute increments.

For the setting procedure, see "[Operation Panel Settings](#)" on page 229 or "[Printer settings](#)" on page 205.



- The cleaning takes 3 to 14 minutes.
- If you set a time within less than 10 minutes from the current time, the cleaning is run at the set time 24 hours later.

### Execution of the Periodic Auto Cleaning

At the set time, the cleaning is automatically run if the printer is on and it determines that the cleaning is necessary.



- If the printer has been left unused without being powered on for a long time, the cleaning may be run when the printer is turned on.
- In the following cases, the cleaning is not run at the set time. It is run next time the printer is turned on.
  - The printer is not powered on.
  - The ink level is too low to run the cleaning, or some ink cartridge(s) needs to be replaced.
  - The remaining amount of space in the maintenance box is too low to run the cleaning, or the box needs to be replaced.

### Examples of the Time Setting to Avoid Interrupting Printing Operation

The followings are examples of the cleaning start time setting to reduce the likelihood of unintended cleaning during printing.

#### In the case that the printer is always powered on

Set the time to a time that printing work is not performed, such as midnight.

#### In the case that the printer is powered on and off every day

- Set the time to a time that the printer is off, such as midnight, to let the printer run the cleaning right after it is powered on.
- If printing work is not performed during lunch break, set the time to a time such as 12:00 in order to let the printer run the cleaning during the lunch break.

# Checking the Printer Status

## Printing the Status Sheet

By printing the status sheet, you can check the firmware version and the current printer settings, such as print mode and media detection settings.

On the operation panel, select the menu in the order shown below to print the status sheet.

[Menu] - [Printer Status/Print] - [Print Status Sheet]



To print the status sheet, load paper that has a label that measures at least 4 inches width and 6 inches long.

**IMPORTANT**

Status Sheet Example	Status Sheet (Network Settings) Example
<pre> &lt;Printer Status Sheet&gt; Sheet Output Time YYYY.MM.DD hh:mm  &lt;Basic Information&gt; Model XX-XXXXX BK Serial Number XXXXXXXXXX Main Firmware Version XXXXXXXXX MAC Address XX:XX:XX:XX:XX:XX IP Address Setting Auto/Manual IP Address XXX.XXX.XXX.XXX Subnet Mask XXX.XXX.XXX.XXX Gateway Address XXX.XXX.XXX.XXX Head ID XXXXXXXXXXXXXXXXXXXXXXXXXXXXXXXXXXXX           </pre> <hr style="border: 0; border-top: 1px solid black; margin: 10px 0;"/> <pre> --  ^^^^  ^^^^ 03  xxxx  yyyy/mm/dd hh:mm 04  xxxx  yyyy/mm/dd hh:mm 05  xxxx  yyyy/mm/dd hh:mm 06  xxxx  yyyy/mm/dd hh:mm 07  xxxx  yyyy/mm/dd hh:mm 08  xxxx  yyyy/mm/dd hh:mm 09  xxxx  yyyy/mm/dd hh:mm 10  xxxx  yyyy/mm/dd hh:mm           </pre>	<div style="border: 1px solid black; padding: 10px; margin: 10px auto; width: 80%;"> <pre> HHH NetWork Status Sheet HHH &lt;General Information&gt; MAC Address      xx:xx:xx:xx:xx:xx Firmware        xxxxxxxxx Network Status   AUTO(Disconnected) &lt;TCP/IP IPv4&gt; Obtain IP Address  Manual IP Address       xxx.xxx.xxx.xxx Subnet Mask      xxx.xxx.xxx.xxx Default Gateway   xxx.xxx.xxx.xxx  HHHHHHHHHHHH 1/1 HHHHHHHHHHHH           </pre> </div>



You can also print a list of registered fonts, barcode fonts, images or templates.

## Printing the Network Connection Check Report

By printing the network connection check report, you can check the network connection status and the network settings.

On the operation panel, select the menu in the order shown below to print the report.

[Menu] - [General Settings] - [Network Settings] - [Connection Check]



### IMPORTANT

To print the network connection check report, load paper that has a label that measures at least 4 inches width and 6 inches long.

### Network Connection Check Report Example

#### Check Network Connection

Check Result	Pass
--------------	------

Network is working correctly.

If your problems persist,  
see your documentation for help and networking tips.

#### Checked Items

Ethernet cable Connection Check	Pass
IP Address Check	Pass
Detailed IP Setup Check	Pass

#### Network Status

Printer Name	XX-XXXXX
Printer Mode1	XXXXXXXXXX
IP Address	XXX.XXX.XXX.XXX
Subnet Mask	XXX.XXX.XXX.XXX
Default Gateway	XXX.XXX.XXX.XXX
Mac Address	XX:XX:XX:XX:XX:XX

## Checking the Status of Consumables

On the home screen of the printer, you can check the following information; the status of the ink cartridges and the maintenance box, paper settings (paper type, detection method, label width/length), remaining amount of paper. ("Home Screen" on page 26)

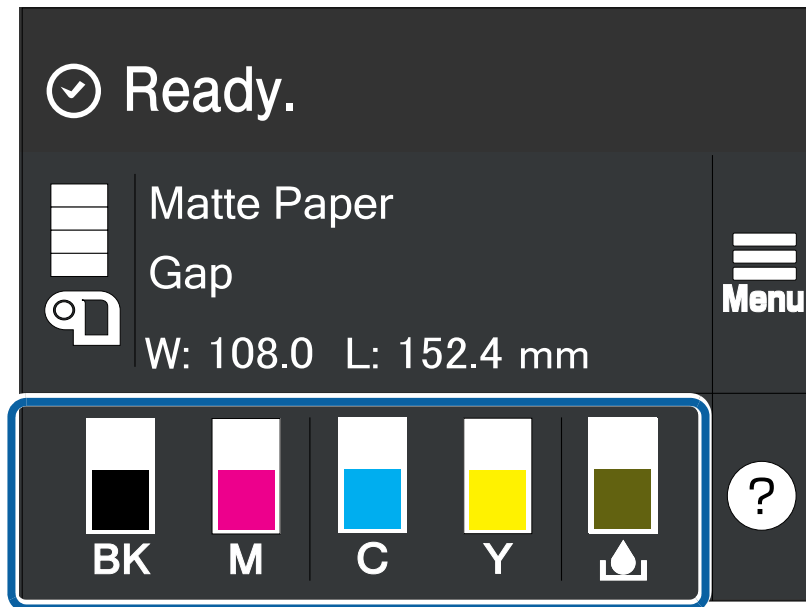

# Setup

This chapter describes procedures for installing and setting up the printer that are required before using the printer.

## Unpacking

After unpacking, make sure that all the printer and the accessories are included and they have no damages. The included items are as follows.

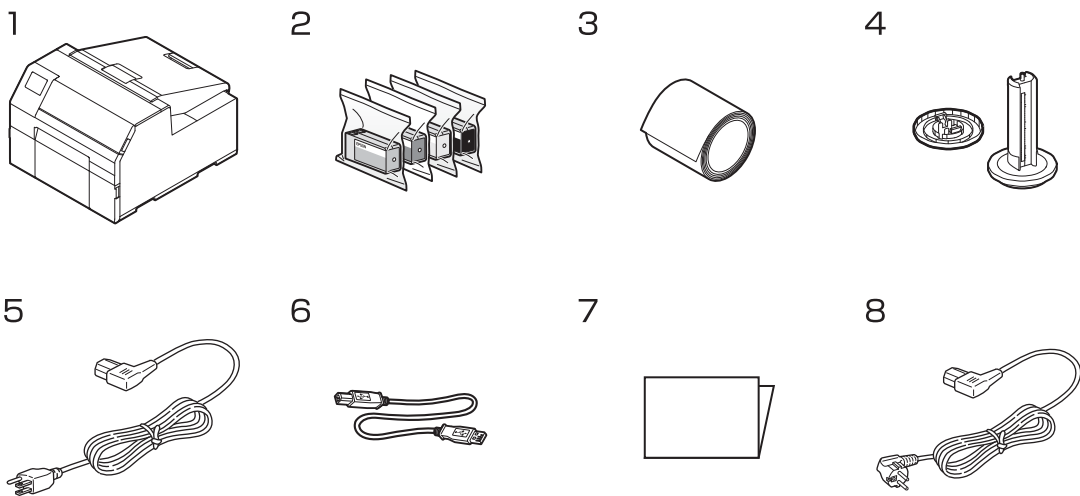

1	Printer (CW-C6000 Series or CW-C6500 Series)	2	Ink cartridges for initial setup: C, M, Y, BK (MK)* * Either one of a BK (gloss black) cartridge or MK (matte black) cartridge is included.
3	Roll paper (for initial operation check)	4	Flange and Spindle
5	Power cable	6	USB cable
7	Manual	8	Power cable for specific regions (not included depending on country or region)

## Removing the Protective Materials

Remove the all protective materials such as pieces of tape and cushion materials. There are about eight protective materials and some of them have been attached to inside the printer.

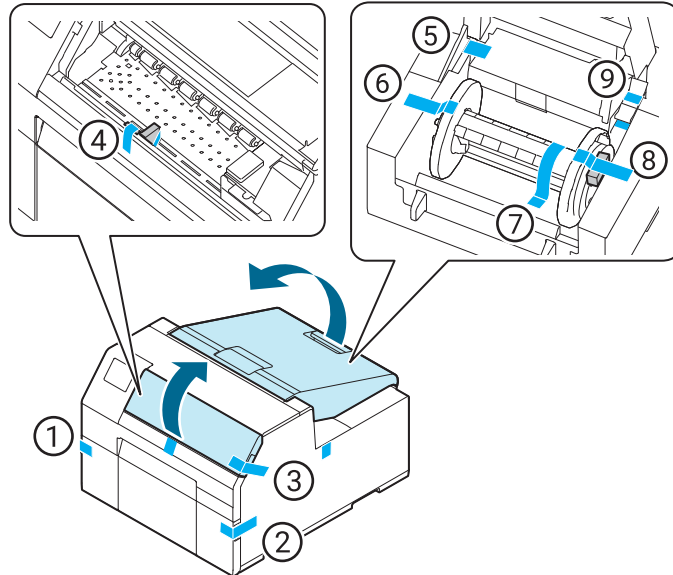

## Installing the Printer

Allow sufficient space for the printer. Make sure that the installation location meets the following requirements.

- On a level and stable surface with sufficient strength to support the weight of the printer

	Auto cutter model	Peeler model
CW-C6000 Series	Approx. 22.5 kg (49.60 lb)	Approx. 22.8 kg (50.27 lb)
CW-C6500 Series	Approx. 25.5 kg (56.22 lb)	Approx. 26.3 kg (57.98 lb)

- On an area larger than the bottom surface of the printer.
- A location that is not subject to vibrations and impacts.
- A location where a dedicated power outlet is available.
- A location where you can load and remove paper without difficulty.
- A location with sufficient space around the printer to allow for installation of accessories, replacement of consumable products, and daily cleaning.
- A location that meets the following environmental requirements.  
For more details, see ["Environmental Specifications" on page 398](#).

		Temperature	Humidity
Printing		5 to 35°C (41 to 95°F)	20 to 80% RH, No condensation
Storage	Gloss black ink	-20 to 40°C (-4 to 104°F)	5 to 85% RH, No condensation (without being unpacked)
	Matte black ink	-10 to 40°C (14 to 104°F)	



- Make sure to carry the printer by two or more persons.
- To lift the printer, put your hands on the indented portions on the side of the printer as shown below. If you put your hands on the other portions of the printer to lift it, the printer may get damaged.

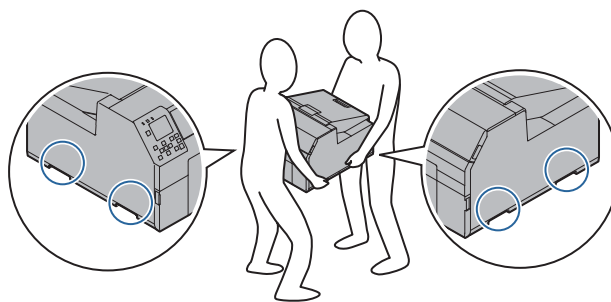

- Do not install the product at a location exposed to strong light such as direct sun rays. Doing so may result in printing failure due to malfunction of the detectors.
- If the printer has charged matte black ink and is more likely to be exposed to a temperature of -10 or lower degrees C (14°F), make sure to discharge ink before turning the printer off. Otherwise, the print head may be damaged due to freezing. For more details, see ["Storing the Printer After Ink is Charged" on page 311](#).

## Connecting the Power Cable

Follow the procedure below to connect the power cable.



### WARNING

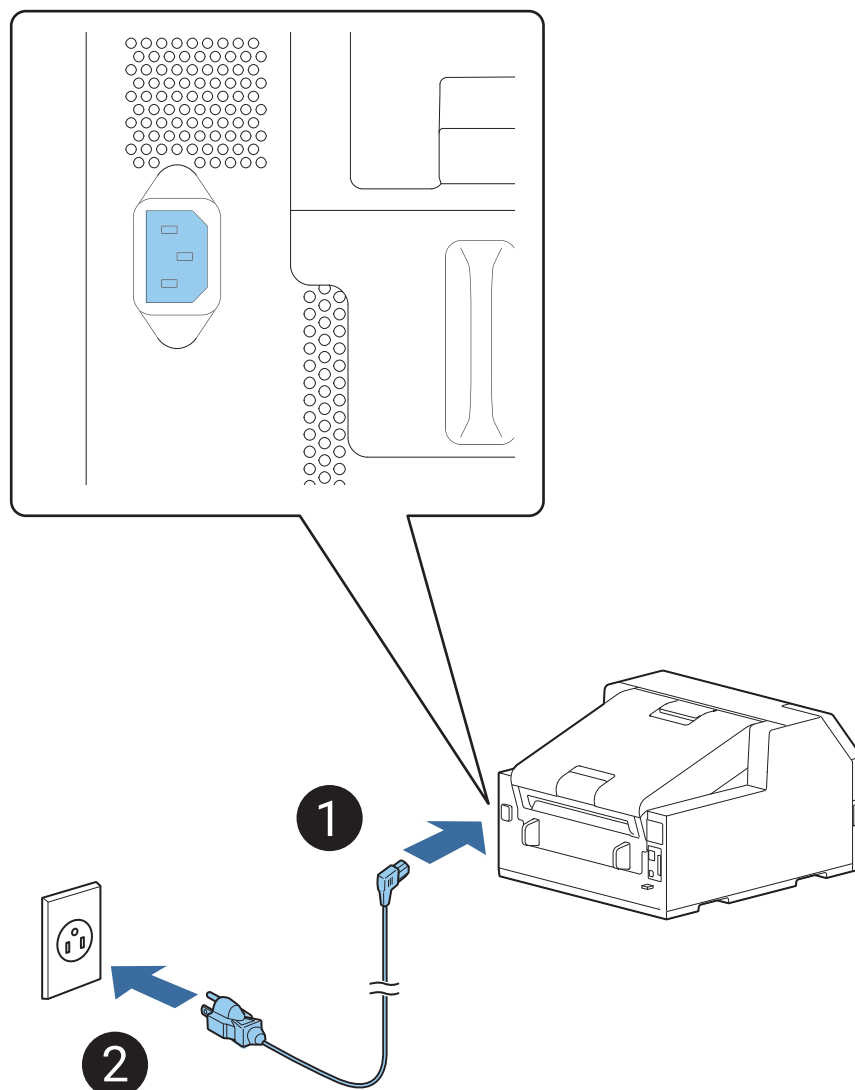

Install the printer near a wall outlet so that you can disconnect the plug from the outlet immediately in the event of an emergency.

- 1** Insert the power cable firmly all the way into the power connector on the back of the printer.
- 2** Insert the power plug firmly all the way into an outlet.





## Turning On/Off

### Turning the Power On

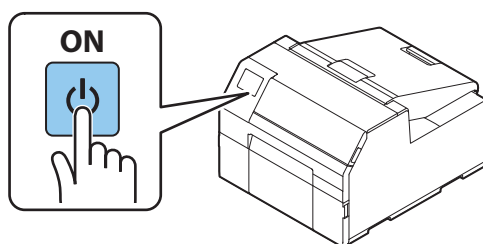
Hold down the  (power) button until the  (power) LED lights up.



### Turning the Power Off

Press the  (power) button. Then select [Yes] on the confirmation screen. The  (power) LED goes out and the printer is turned off.

## Setting Language and Date/Time

Follow the on-screen instructions to set language, the date and time.

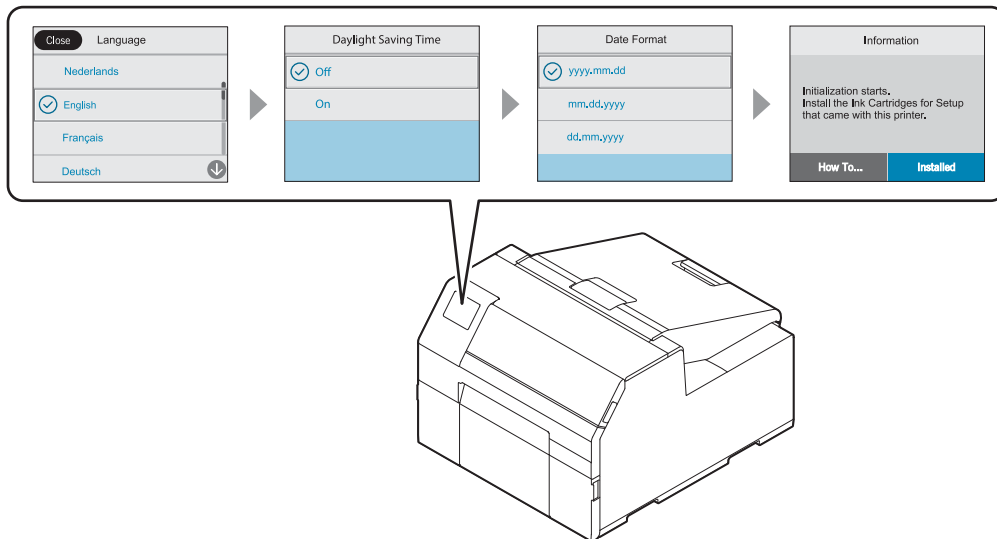

## Selecting Black Ink Type

If the version of the printer firmware is other than TS05JC, TS06JC, TS26JC, TS19K2, TS25K3, or TS21K5, select which type of black ink you use following the on-screen instructions.

On the black ink type confirmation screen, select [Done].

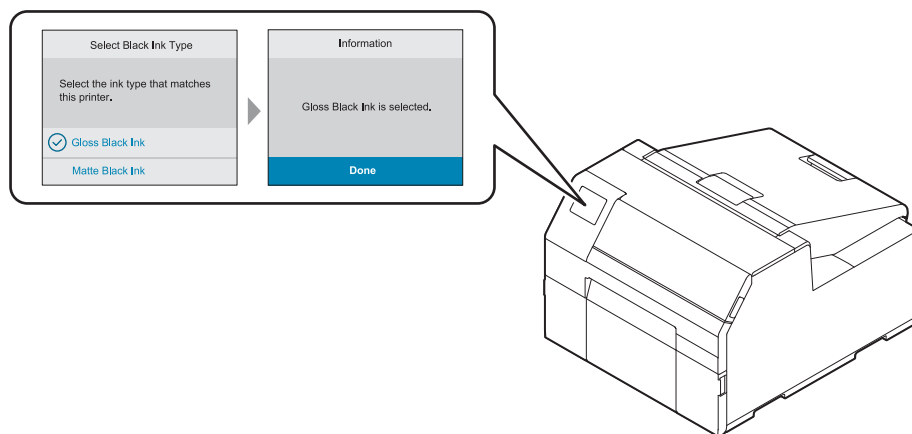

## Installing the Ink Cartridges

Follow the on-screen instructions to install the ink cartridges.

When you close the cover, a message that confirms whether to start initial ink charging is displayed. Select [Yes] to start the initial ink charging. When you see a message saying that the initial ink charging is finished, select [OK].

If the version of the printer firmware is TS05JC, TS06JC, TS26JC, TS19K2, TS25K3, or TS21K5, initial ink charging will start right after you install the cartridges and close the cover. A home screen is displayed when the initial ink charging is finished.

It takes about 19 minutes for the initial ink charging. The time differs according to circumstances.



Before installing the ink cartridges, make sure to read the cautions on handling the ink cartridges. See "[Cautions on Ink Cartridges](#)" on page 8.

Never open any cover of the printer or turn off the printer during ink charging.

Doing so will consume a large amount of ink, which may result in the need to replace the ink cartridges or the maintenance box before the completion of charging.

Once you start the initial ink charging, you cannot change the black ink type.

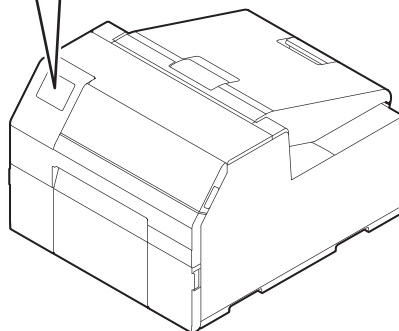
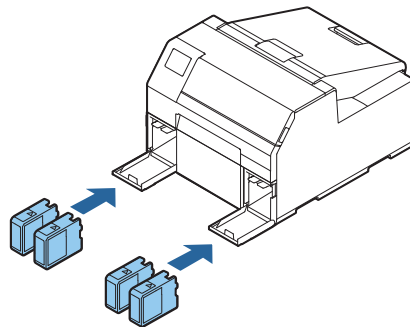

## Replacing the Ink Cartridges

### Checking Amount of Ink Remaining

You can check ink level of each color ink cartridge on the home or an error message screen of the operation panel.

Message	Description
You need to replace Ink Cartridge(s).	To maintain the quality of the print head, the printer stops printing before ink cartridges are completely expended. Replace the ink cartridge with new one.

### How to Replace the Ink Cartridges



#### IMPORTANT

When replacing the black ink cartridge, make sure to replace with a cartridge of the same type of black ink. The printer does not work if you install a cartridge of different type of black ink.

The procedure below is for replacing the BK cartridge. Follow the same procedure for replacing the other color cartridges.

#### 1 Open the left ink cartridge cover.

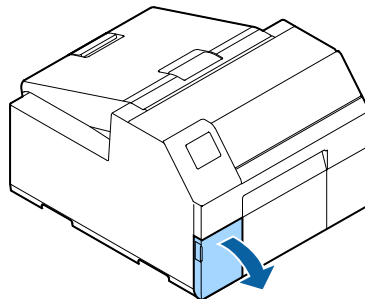

For replacing cyan or yellow cartridge, open the right ink cartridge cover.

#### 2 Press the lever down to remove the used ink cartridge.

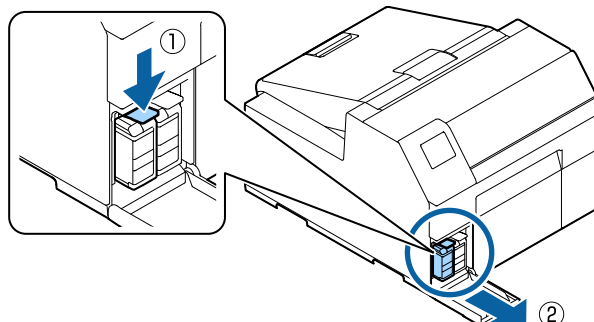

### 3 Open the bag and take out the new ink cartridge.

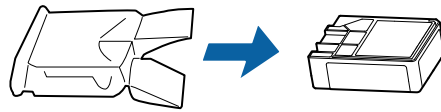

### 4 Shake the ink cartridge.

As shown in the figure below, shake the cartridge horizontally. Move the cartridge by about 5 cm to both directions, and repeat it about 15 times for about 5 seconds.

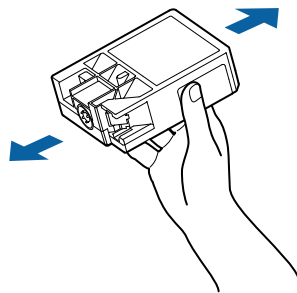

### 5 Install the ink cartridge in the slot.

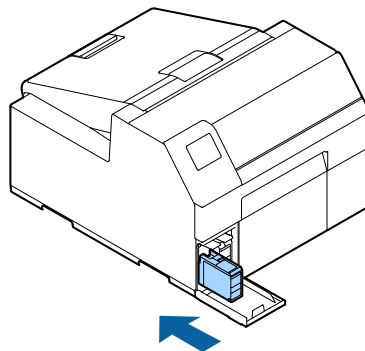

### 6 Close the ink cartridge cover.

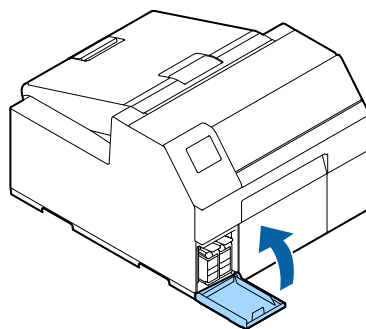

## Installing the Maintenance Box

The printer comes with the maintenance box installed.



Before handling the maintenance box, make sure to read the cautions on handling the maintenance box.  
See "[Cautions on the Maintenance Box](#)" on page 9.

### Replacing the Maintenance Box

#### Checking the Amount of Empty Space in the Maintenance Box

You can check the remaining capacity of the maintenance box on the home or an error message screen of the operation panel.

Message	Description
The Maintenance Box is at the end of its service life. You need to replace it.	Replace the maintenance box with a new one.

#### How to Replace the Maintenance Box



The maintenance box is the same for the CW-C6000/C6500 Series and the CW-D6000/D6500 Series.

You can install a new maintenance box to either series.

However, do not install it to a printer of a different series midway through use.  
Doing so may hamper the maintenance box functions.

#### 1 Open the paper cover.

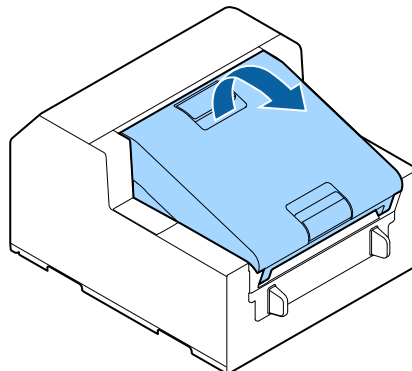

## 2 Open the maintenance box cover.

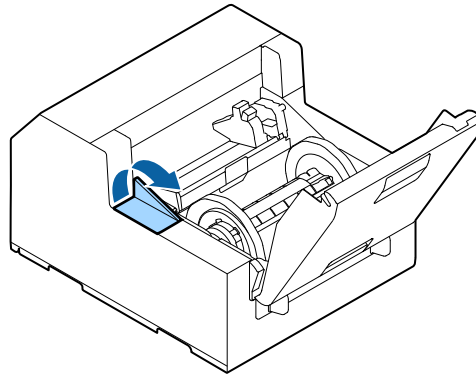

## 3 Take out the maintenance box.

When disposing of the used maintenance box, put it in a plastic bag that came with the new maintenance box.

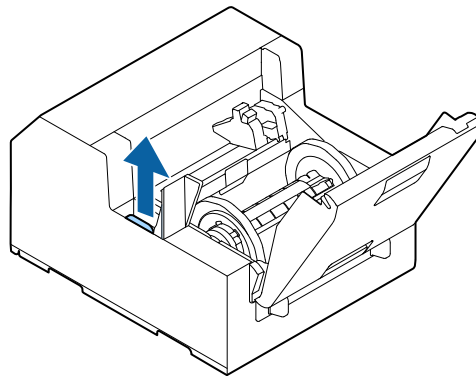

## 4 Take out a new maintenance box from the bag.

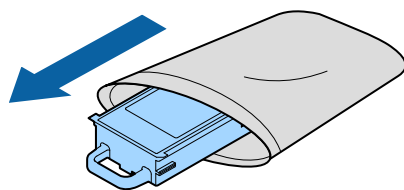

## 5 Install the new maintenance box.

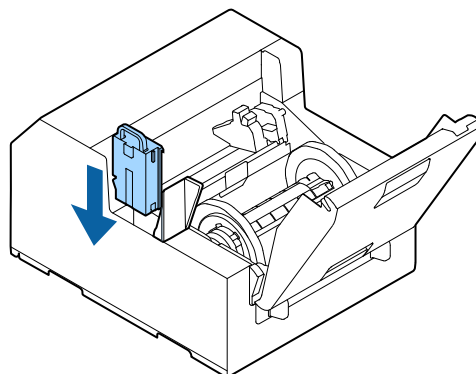

## 6 Close the maintenance box cover.

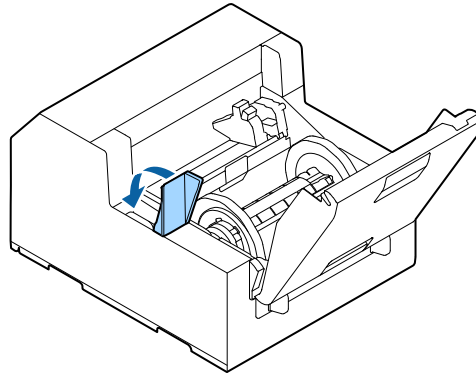

## Installing the Printer Driver and Connecting to a Computer

 Do not connect the printer to your computer until the screen prompts you to do so.

**CAUTION**

 When connecting with a USB cable, pass the cable through the wire saddle to prevent accidental disconnection.

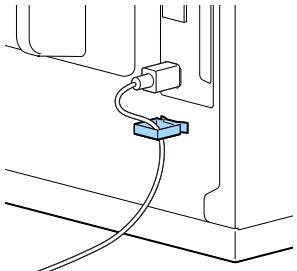

### 1 Go to the website below and search for your printer model number to download the printer driver.

You can get the software from the following website.

For customers in North America, go to the following web site: <https://www.epson.com/support/>

For customers in other countries and regions, go to the following web site: <https://epson.sn>

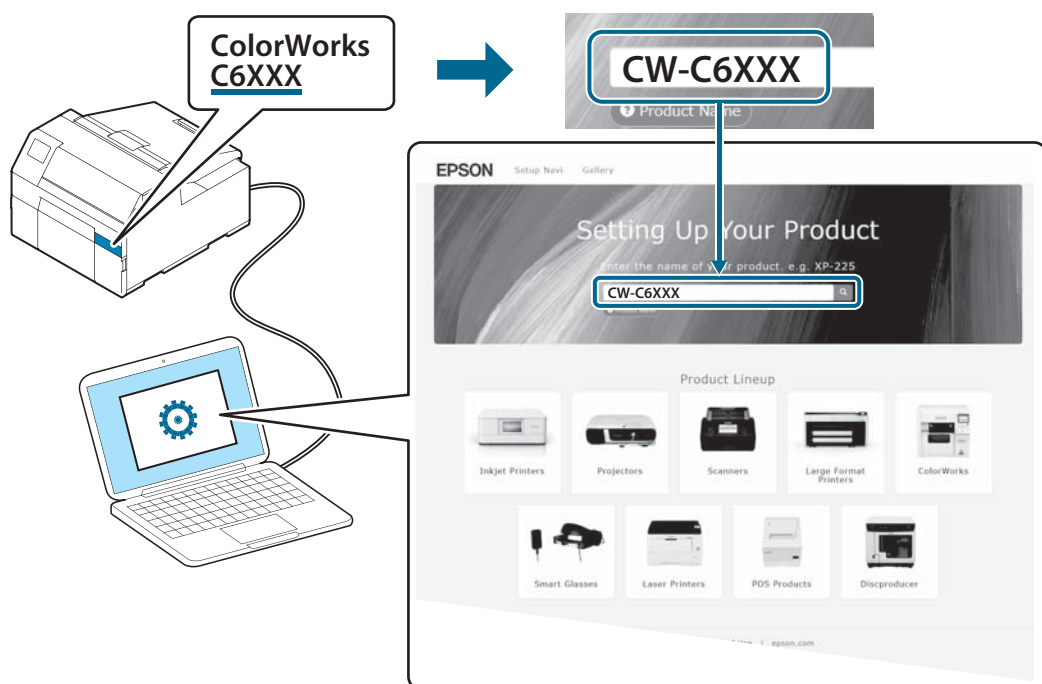

The diagram illustrates the process of finding the printer driver. It shows a printer with a callout box containing the text "ColorWorks C6XXX". An arrow points from this callout to a search bar containing the text "CW-C6XXX". Below this, a screenshot of the Epson website's "Setting Up Your Product" page is shown, with the search bar containing "CW-C6XXX" and a dropdown menu showing various product categories like Inkjet Printers, Projectors, Scanners, Large Format Printers, ColorWorks, Smart Glasses, Laser Printers, POS Products, and Discproducer.

### 2 Start the printer driver.

### 3 Follow the on-screen instructions to install the printer driver.

During the installation process, you will be guided to connect the computer to the printer.

## How to Configure the Network Settings

Follow the procedure below to set up the IP address of the printer.



- To connect to the printer via Ethernet, the network settings are required. When connecting to the printer via USB, the network settings are not required.
- Before starting the network settings, ask your network administrator for information required for the network settings.

- 1 Turn the printer on.**
- 2 Select [Menu] and then press the [OK] button.**
- 3 Select [General Settings] and then press the [OK] button.**
- 4 Select [Network Settings] and then press the [OK] button.**
- 5 Select [Advanced] and then press the [OK] button.**
- 6 Select [TCP/IP] and then press the [OK] button.**
- 7 Select [Obtain IP Address] and then select [Auto] or [Manual] using the [OK] button.**  
When you select [Auto], the network setting is complete.  
When you select [Manual], proceed to step 8.
- 8 Enter the IP address and the subnet mask.**  
Select a setting to change and then press the [OK] button to enter the information.
- 9 Select [Start Setup] and then press the [OK] button.**

The network setting is now complete.

## Media Settings

Configure the media source to use, and type, shape, detecting method of media to use.

- When using the Windows printer driver  
See "[Printer Driver for Windows](#)" on page 75.
- When Not using the Windows printer driver  
See "[PrinterSetting \(Windows\)](#)" on page 187.
- When configuring the settings without using a computer  
See "[Operation Panel Settings](#)" on page 229.



- If the settings on the printer (settable using the operation panel, PrinterSettings, or Web Config) differ from the printer driver settings, printing is performed by applying the printer driver settings.
- For media that can be used with this product, refer to "[Paper Specifications](#)" on page 361.

## Opening the Paper Cover

This section describes how to open the paper cover.



### CAUTION

Do not use the printer with the paper cover removed. Doing so will cause the printer to malfunction.

### Opening the Cover using the Lever in the Front

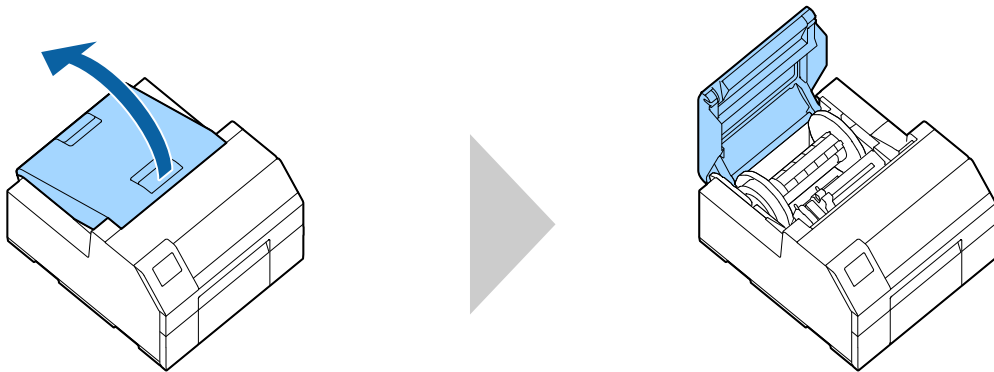

Open the paper cover as shown above for the following purposes.

- To load roll paper inside the printer, or to remove it.
- To replace the maintenance box.
- To clean inside the printer.
- To remove paper jammed inside the printer.

### Opening the Cover using the Lever in the Back

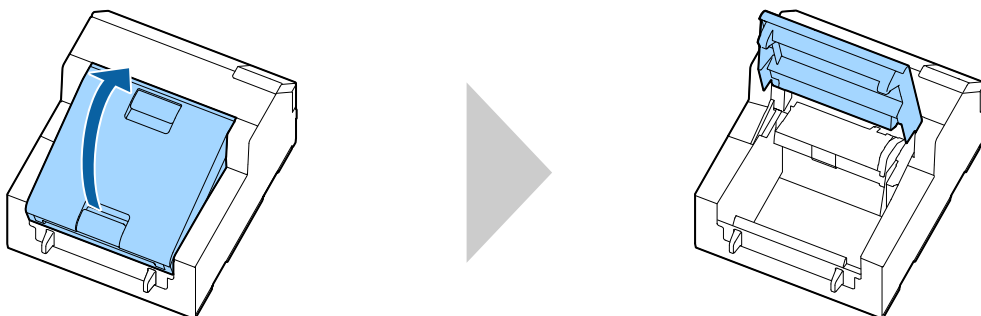

Open the paper cover as shown above for the following purposes.

- To set paper so that it is supplied from outside the printer, or to remove the paper.

## Loading Paper

This section describes how to load and replace paper. As shown below, the procedure of replacing paper differs depending on the size and whether paper has been/is going to be supplied from inside or outside.

Videos that show the procedure are also available.

Click the URL below to view the videos.

[https://support.epson.net/p\\_doc/790/](https://support.epson.net/p_doc/790/)

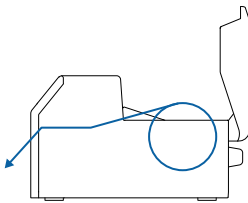
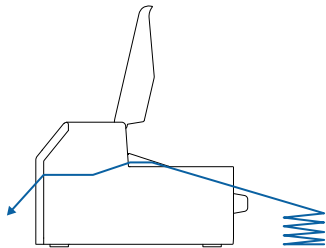
<p>Supply from Inside (Internal)</p> <p>Paper is supplied from inside the printer. Set roll paper attached to the spindle into the printer.</p> 	<p>Supply from Outside (Rear Feed)</p> <p>Paper is supplied from outside the printer. Place roll paper or fanfold paper behind the printer.</p> 
---	--

  
**IMPORTANT**

- To supply roll paper from outside the printer, prepare an external paper feeder and paper rewriter by yourself. For more details, see ["Requirements for External Devices" on page 410](#).
- With the peeler model, you cannot supply fanfold paper from outside the printer.
- When replacing paper with a different shape, form, or type of paper, change the paper settings either from the operation panel or on the printer driver before loading the paper. (["Operation Panel Settings" on page 229](#), ["Media Source and Media Detection Settings" on page 85](#), ["User-Defined Paper" on page 87](#))

Models	Supply from Inside (Internal)	Supply from Outside (Rear Feed)	
		Fanfold paper	Roll paper
Auto cutter model	<ul style="list-style-type: none"> <li>• Paper loading: <a href="#">Page 52</a></li> <li>• Paper removal: <a href="#">Page 66</a></li> <li>• Paper ejection at paper end: <a href="#">Page 70</a></li> </ul>	<ul style="list-style-type: none"> <li>• Paper loading: <a href="#">Page 56</a></li> <li>• Paper removal: <a href="#">Page 66</a></li> <li>• Paper ejection at paper end: <a href="#">Page 70</a></li> </ul>	<a href="#">"Requirements for External Devices" on page 410</a>
Peeler model	<ul style="list-style-type: none"> <li>• Paper loading: <a href="#">Page 60</a></li> <li>• Paper removal: <a href="#">Page 68</a></li> <li>• Paper ejection at paper end: <a href="#">Page 71</a></li> </ul>	/	<a href="#">"Requirements for External Devices" on page 410</a>

## How to Load Paper (Auto Cutter Model - Supply from Inside)



### CAUTION

After turning on the printer, do not open the paper cover until the home screen is displayed. Doing so may cause paper to be set improperly.

- 1 Turn on the printer, and then check that [Internal] is selected as the [Media Source] setting on the operation panel.  
(["Operation Panel Settings" on page 229](#))

- 2 Open the paper cover.

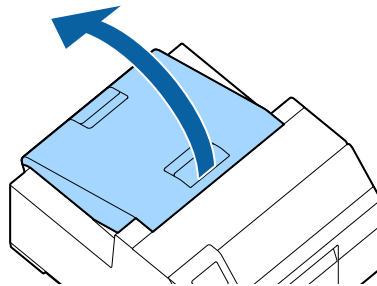

- 3 Remove the spindle from the printer.  
As shown in the figure, hold the spindle and flange with both hands, and remove them.

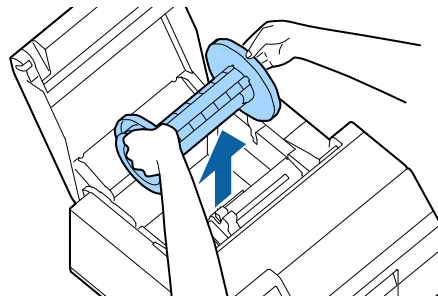

- 4 Load the roll paper on the spindle and fix it with the flange.

- To move the flange, squeeze the two levers.
- When loading the roll paper on the spindle, take note of the winding direction. The correct winding direction is marked on the spindle.
- Fix the flange and roll paper so that there is no gap in between.

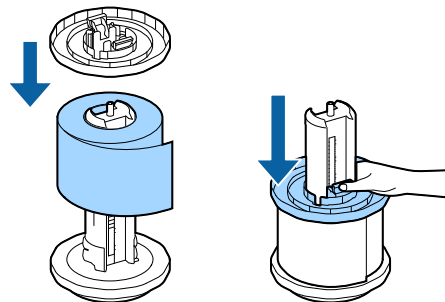

- 5 Hold the spindle with both hands, and set it in the printer.**  
Install the spindle so that both ends of the spindle fit into the holders inside the printer.

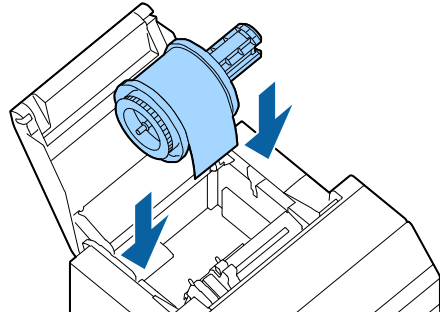

- 6 Slide the movable edge guide to the right side.**  
Squeeze the blue lever to move the edge guide.

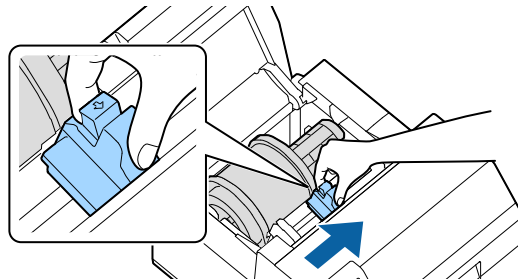

- 7 Pull the paper along the left edge guide.**

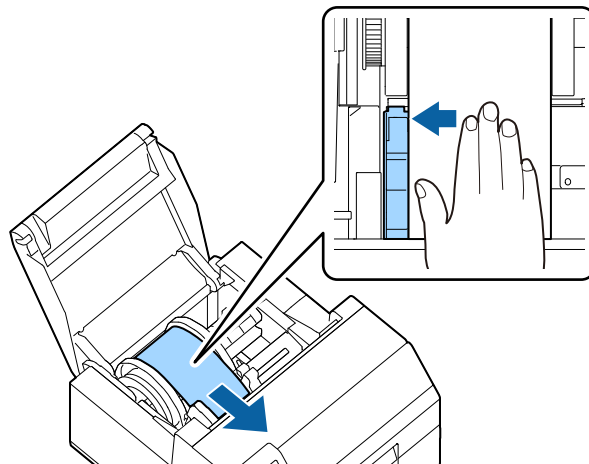

- 8** Place your hand on the paper to flatten it, and slide the movable edge guide against the paper.

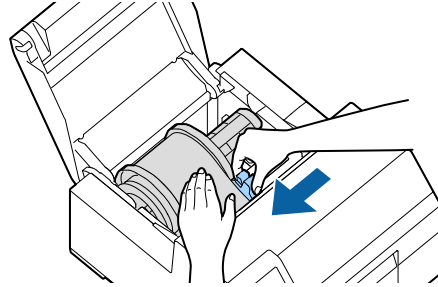

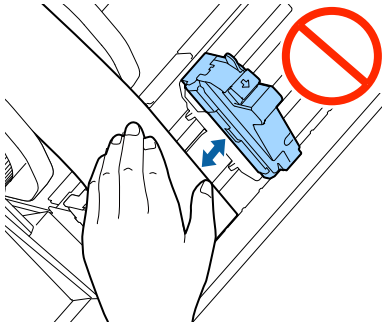
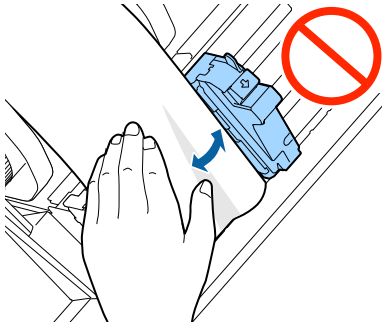
<p> <b>CAUTION</b></p>	<p>If the movable edge guide is not properly slid against the paper, print position may become incorrect or a paper jam may occur. Make sure to follow the guidelines below.</p>	
	<ul style="list-style-type: none"> <li>• There should be no gap between the guide and the paper edge.</li> </ul> 	<ul style="list-style-type: none"> <li>• Do not slide the guide against the paper too tightly.</li> </ul> 

- 9** Insert the paper into the paper feed slot until paper feeding starts automatically.  
Do not load backing paper that has no labels on it. The paper may not be detected and not be fed automatically.

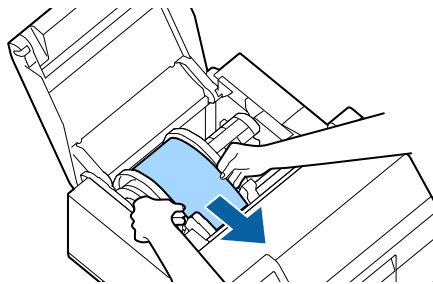

If you are using special paper, the paper may not be fed into printer automatically because the printer can fail to detect the paper. To feed the paper into the printer manually, see "[Feeding Paper into the Printer Manually](#)" on page 72.

**10** Rotate the spindle to remove looseness in the paper.

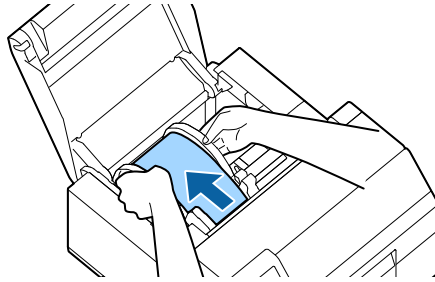

**11** Close the paper cover.

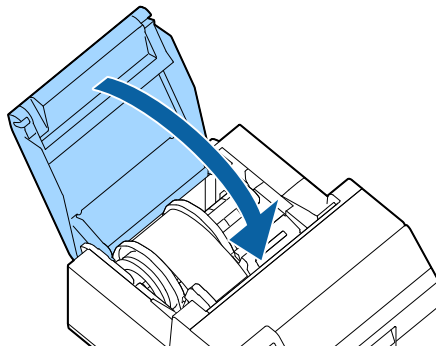

**12** Press the [Pause] button.

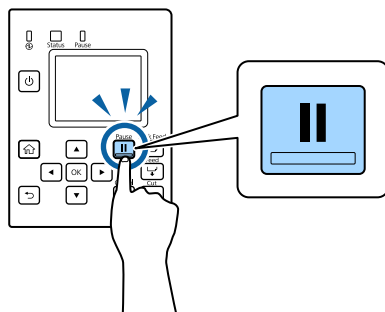

Loading paper (auto cutter model - supply from inside) is now completed.

## How to Load Paper (Auto Cutter Model - Supply from Outside)



### CAUTION

After turning on the printer, do not open the paper cover until the home screen is displayed. Doing so may cause paper to be set improperly.

- 1 Turn on the printer, and then check that [Rear Feed] is selected as the [Media Source] setting on the operation panel.**  
(["Operation Panel Settings" on page 229](#))

- 2 Open the paper cover.**

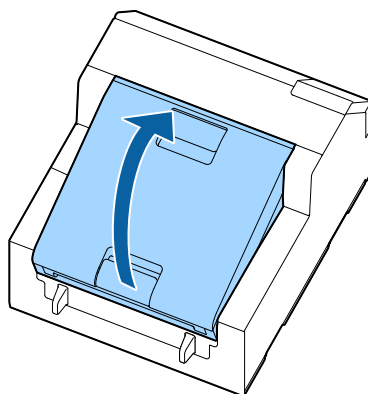

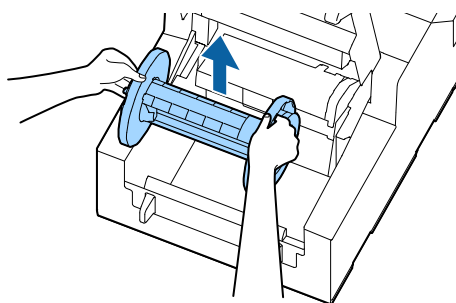

- 3 Remove the spindle, if present.**  
As shown in the figure, hold the spindle and flange with both hands, and remove them.

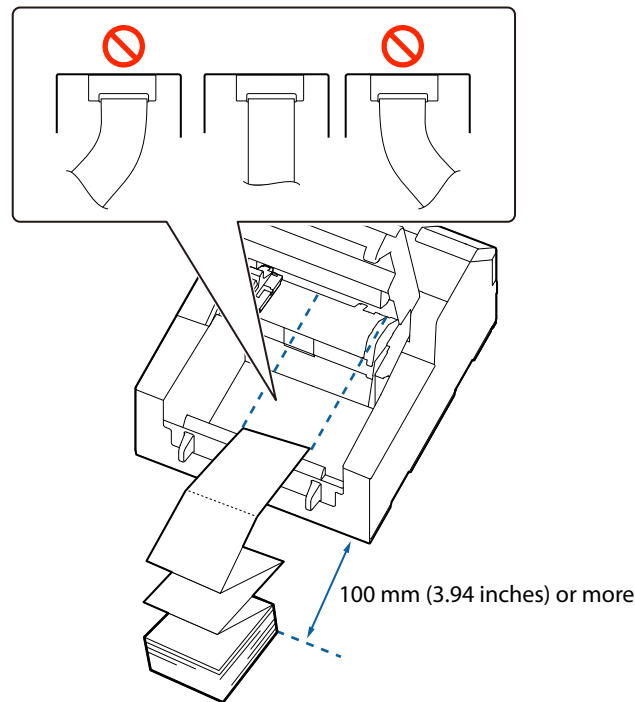

#### 4 Place the fanfold paper behind the printer.

- Place the fanfold paper at least 100 mm (3.94 inches) away from the printer.
- Make sure the paper is vertical in relation to the paper feed slot.



 <b>CAUTION</b>	<p>Make sure not to let the fanfold paper to curl near the printer. Doing so will deform the paper resulting in a paper jam or a print quality problem.</p>

#### 5 Slide the movable edge guide to the left side.

Squeeze the blue lever to move the edge guide.

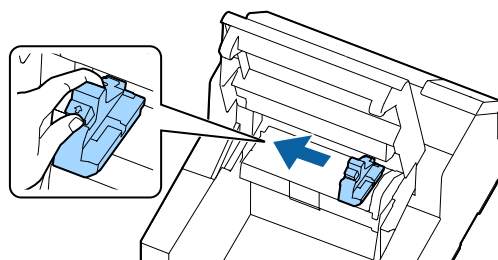

## 6 Pull the paper along the right edge guide.

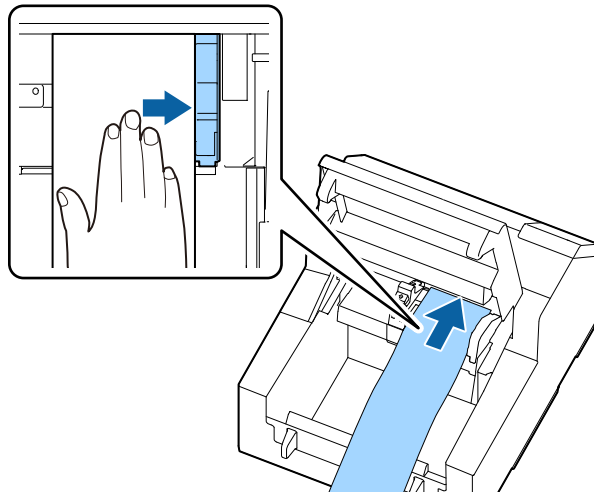

## 7 Place your hand on the paper to flatten it, and slide the movable edge guide against the paper.

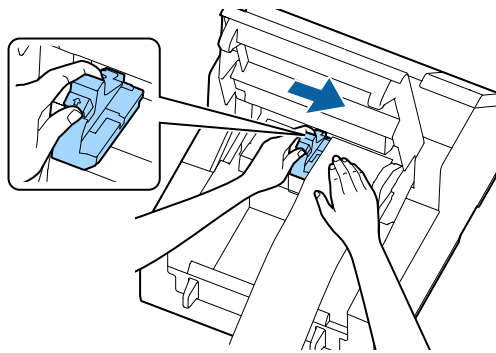

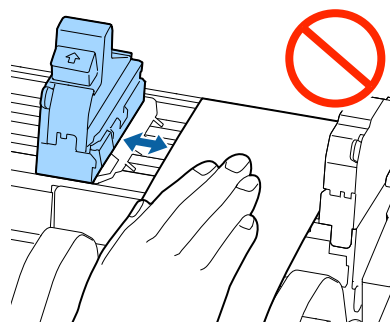
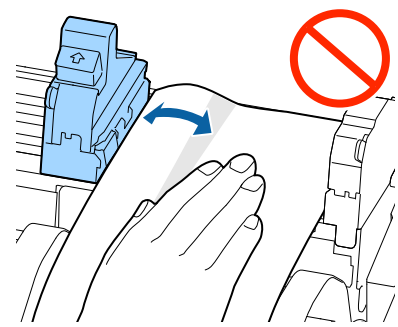
 <b>CAUTION</b>	<p>If the movable edge guide is not properly slid against the paper, print position may become incorrect or a paper jam may occur. Make sure to follow the guidelines below.</p>	
	<ul style="list-style-type: none"> <li>There should be no gap between the guide and the paper edge.</li> </ul> 	<ul style="list-style-type: none"> <li>Do not slide the guide against the paper too tightly.</li> </ul> 

- 8** Insert the paper into the paper feed slot until paper feeding starts automatically.  
Do not load backing paper that has no labels on it. The paper may not be detected and not be fed automatically.

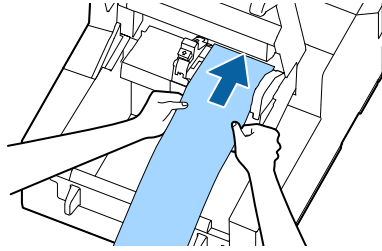

- 9** Close the paper cover.

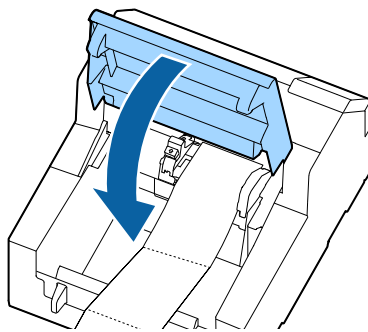

- 10** Press the [Pause] button.

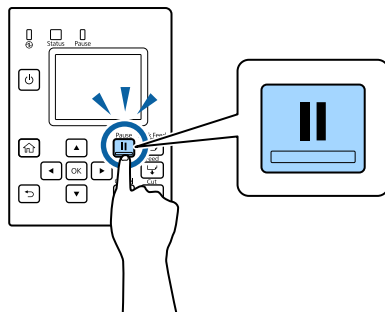

Loading paper (auto cutter model - supply from outside) is now completed.

## How to Load Paper (Peeler Model - Supply from Inside)



### CAUTION

After turning on the printer, do not open the paper cover until the home screen is displayed. Doing so may cause paper to be set improperly.

- 1 Turn on the printer, and then check that [Internal] is selected as the [Media Source] setting on the operation panel.  
(["Operation Panel Settings" on page 229](#))

- 2 Open the paper cover

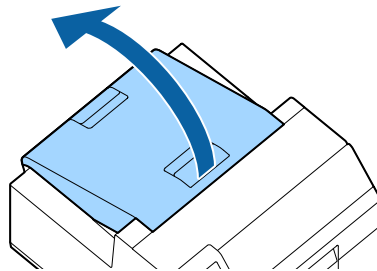

- 3 Remove the spindle from the printer.

As shown in the figure, hold the spindle and flange with both hands, and remove them.

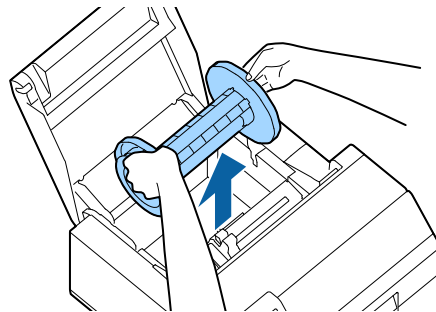

- 4 Load the roll paper on the spindle and fix it with the flange.

- To move the flange, squeeze the two levers.
- When loading the roll paper on the spindle, take note of the winding direction. The correct winding direction is marked on the spindle.
- Fix the flange and roll paper so that there is no gap in between.

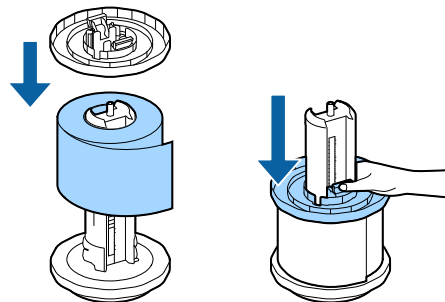

- 5 Hold the spindle with both hands, and set it in the printer.**  
Install the spindle so that both ends of the spindle fit into the holders inside the printer.

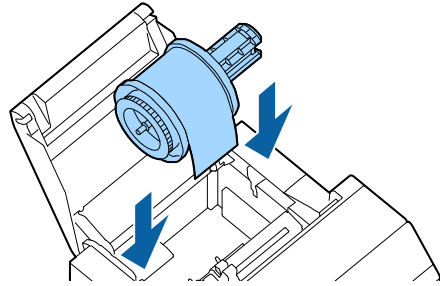

- 6 Slide the movable edge guide to the right side.**  
Squeeze the blue lever to move the edge guide.

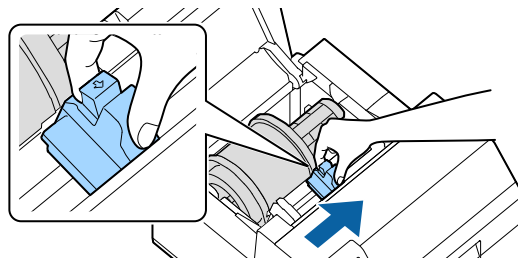

- 7 Pull the paper along the left edge guide.**

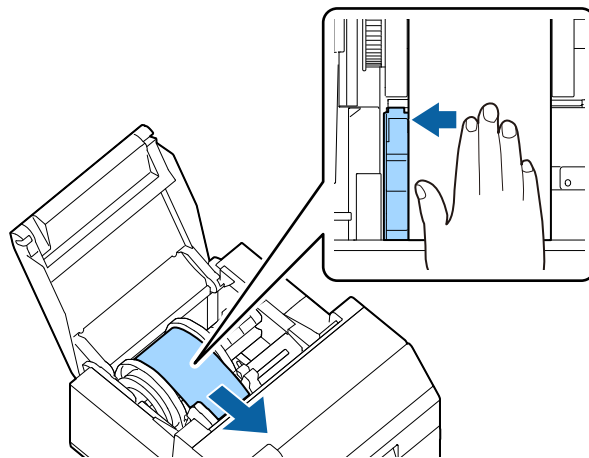

- 8** Place your hand on the paper to flatten it, and slide the movable edge guide against the paper.

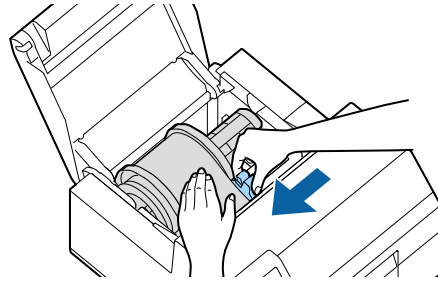

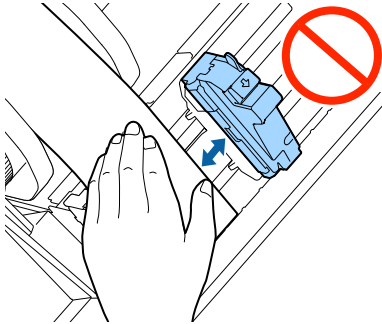
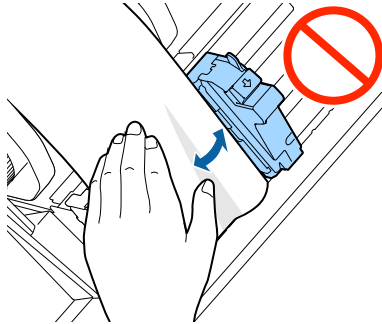
 <b>CAUTION</b>	<p>If the movable edge guide is not properly slid against the paper, print position may become incorrect or a paper jam may occur. Make sure to follow the guidelines below.</p>	
	<ul style="list-style-type: none"> <li>• There should be no gap between the guide and the paper edge.</li> </ul> 	<ul style="list-style-type: none"> <li>• Do not slide the guide against the paper too tightly.</li> </ul> 

- 9** Insert the paper into the paper feed slot until paper feeding starts automatically. Do not load backing paper that has no labels on it. The paper may not be detected and not be fed automatically.

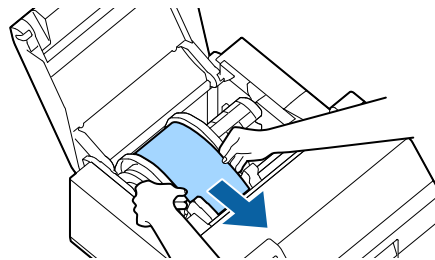

If you are using special paper, the paper may not be fed into printer automatically because the printer can fail to detect the paper. To feed the paper into the printer manually, see "[Feeding Paper into the Printer Manually](#)" on page 72.

**10** Rotate the spindle to remove looseness in the paper.

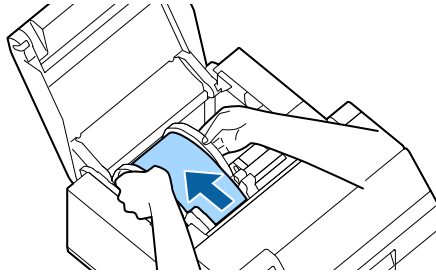

**11** Close the paper cover.

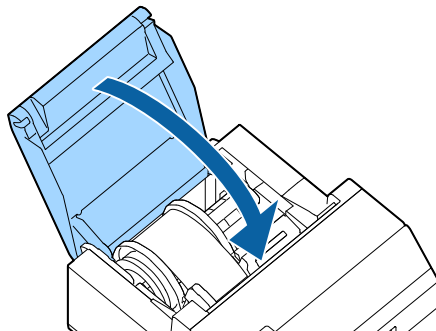

**12** Hold down the [Feed] button until the leading edge of paper touches the table on which the printer is installed.

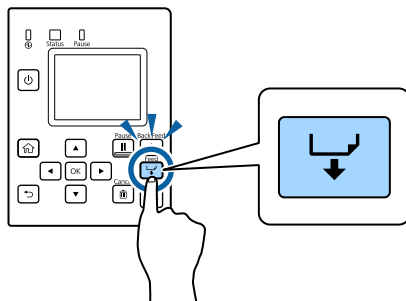

**13** Remove labels from the ejected paper.

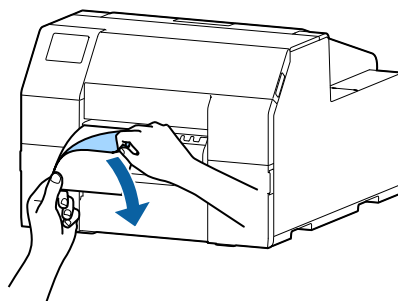

**14** Open the peeler cover.

Do not touch the manual cutter at the bottom of the peeler cover with your hand. Doing so may cause injury. ("Caution Label" on page 10)

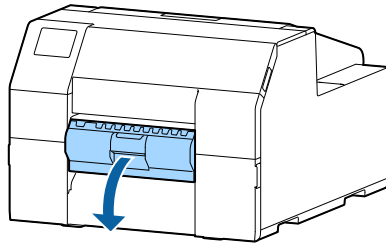
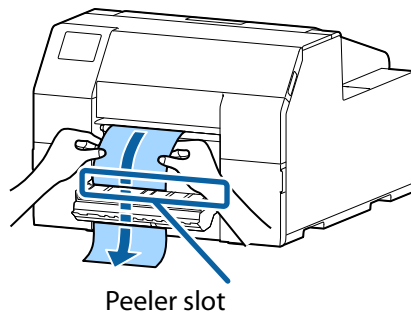
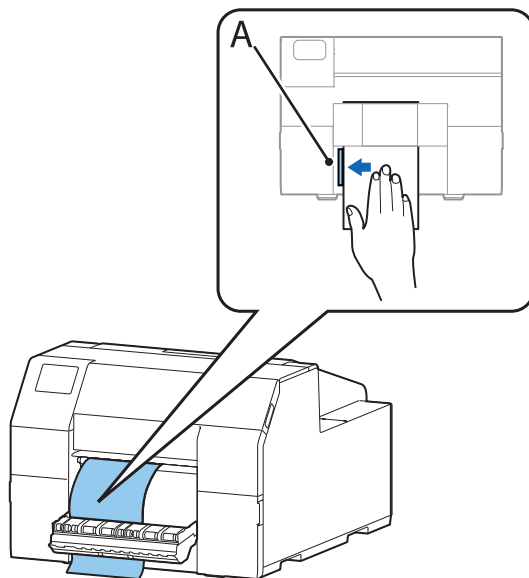
**15** Pass the paper through the peeler slot.**16** Before closing the peeler cover, load the paper along the protrusion A.

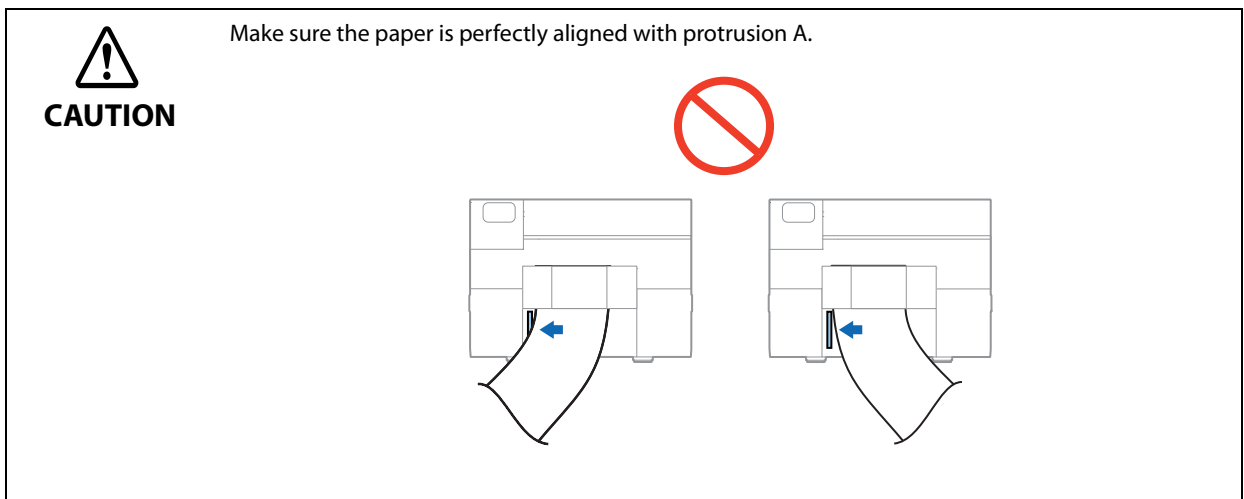

## 17 Close the peeler cover.

If the paper is loose, pull the leading edge of paper to remove the looseness and then close the peeler cover.

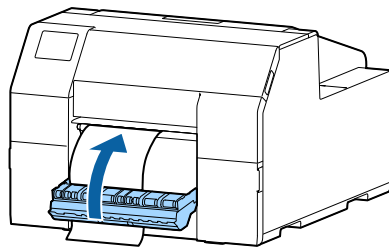

## 18 Press the [Pause] button.

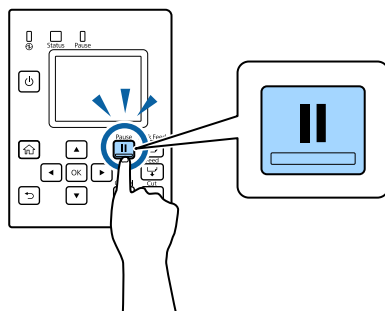

Loading paper (peeler model - supply from inside) is now completed.

## How to Remove Paper (For the Auto Cutter Model)

- 1 Check that the printer has been turned on.
- 2 Press the [Cut] button, and cut off the ejected labels.

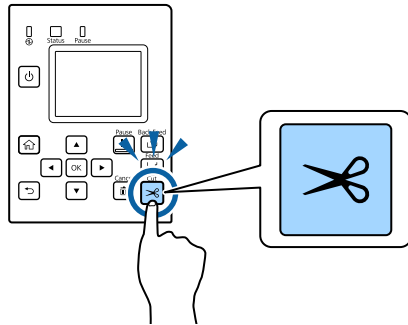

- 3 Press the [Back Feed] button to feed the paper backward.  
The paper can now be pulled out from inside the printer.

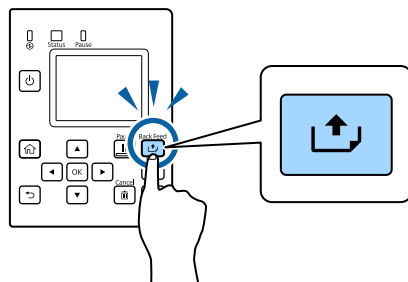

- 4 Open the paper cover.

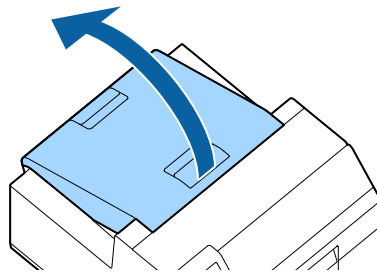

- 5 Slide the movable edge guide away from the paper, and remove the paper.

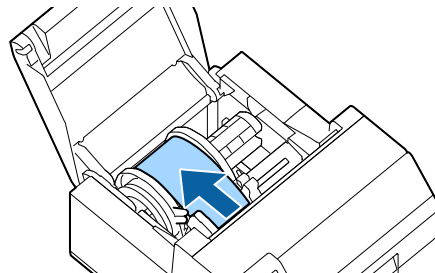

- 6 Close the paper cover.

## **7 Press the [Pause] button.**

Removing the paper is now completed.

To load paper, see the following pages.

["How to Load Paper \(Auto Cutter Model - Supply from Inside\)" on page 52](#), ["How to Load Paper \(Auto Cutter Model - Supply from Outside\)" on page 56](#)

## How to Remove Paper (For the Peeler Model)

**1** Check that the printer has been turned on.

**2** Open the peeler cover.

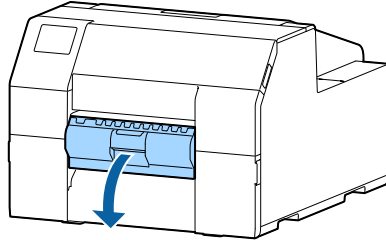

**3** Cut the backing paper near the paper ejection slot.

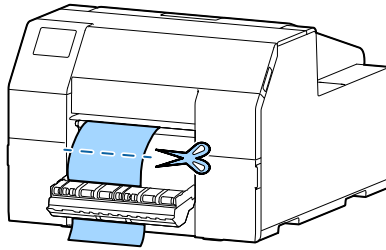

**4** Press the [Back Feed] button to feed the paper backward.  
The paper can now be pulled out from inside the printer.

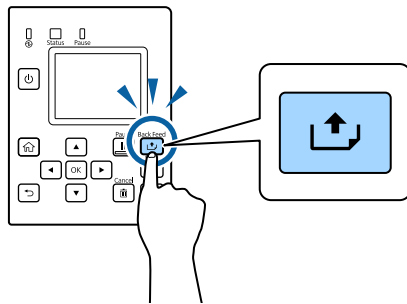

**5** Open the paper cover.

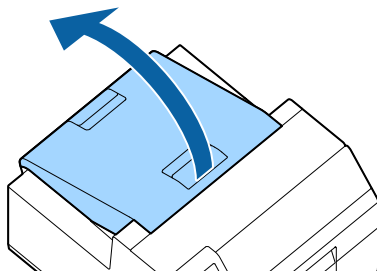

- 6 Slide the movable edge guide away from the paper, and remove the paper.

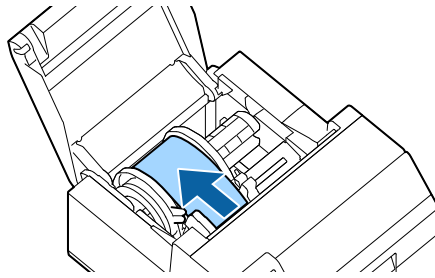

- 7 Close the paper cover.
- 8 Press the [Pause] button.

Removing the paper is now completed.

To load paper, see the following pages.

["How to Load Paper \(Peeler Model - Supply from Inside\)" on page 60](#)

## How to Eject Paper at Paper End (For the Auto Cutter Model)

- 1 Hold down the Feed button until the paper is completely ejected.

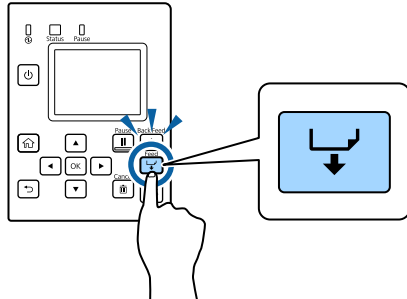

Ejecting paper at paper end is now completed.

To load paper, see the following pages.

["How to Load Paper \(Auto Cutter Model - Supply from Inside\)" on page 52](#), ["How to Load Paper \(Auto Cutter Model - Supply from Outside\)" on page 56](#)

## How to Eject Paper at Paper End (For the Peeler Model)

- 1 Open the peeler cover.

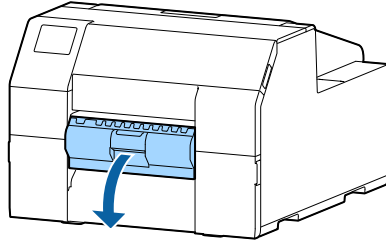

- 2 Remove the paper from the peeler slot.

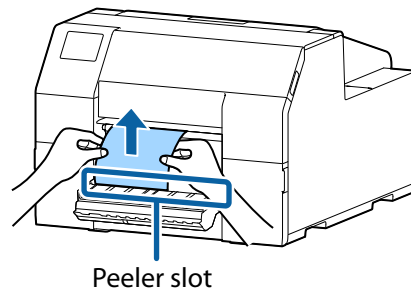

- 3 Hold down the Feed button until the paper is completely ejected.

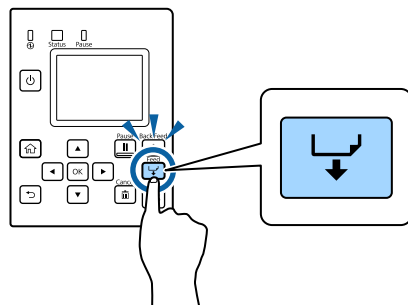

Ejecting paper at paper end is now completed.

To load paper, see the following pages.

["How to Load Paper \(Peeler Model - Supply from Inside\)" on page 60](#)

## Feeding Paper into the Printer Manually

If you are using special paper, the paper may not be fed into the printer automatically because the printer can fail to detect the paper. In such case, follow the procedure below to feed the paper manually.



### CAUTION

If this manual feeding method is used, the printer operation and print quality are not guaranteed.

- 1 Advance the paper with your hand until the leading edge comes in contact with the paper feed shaft.**

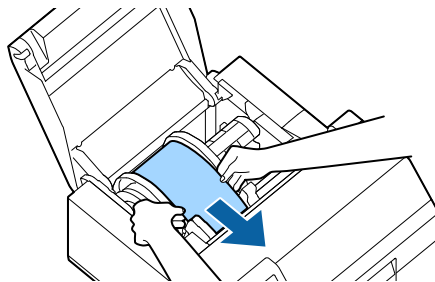

- 2 Hold down the paper with your hand and press the Feed button.**

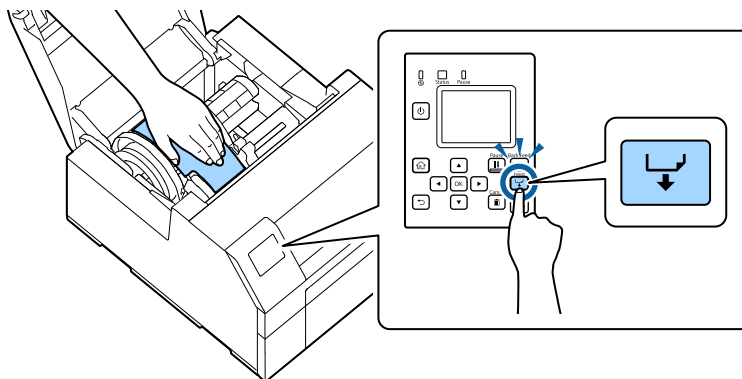

## Test Print

You can check whether the printer operates normally or not by printing a nozzle check patterns.

Follow the procedure below to print the nozzle check patterns. The nozzle check patterns allow you to check print nozzles for clogging.

- 1** Turn the printer on.
- 2** Select [Menu] and then press the [OK] button.
- 3** Select [Maintenance].
- 4** Select [Print Head Nozzle Check].
- 5** Select [Print].  
The nozzle check patterns are printed.

### 6 Checking the Nozzle Check Patterns

If the pattern is printed normally, all the lines are printed properly as shown in the left figure below. Nozzles are clogging if there are missing lines as shown in the right figure below. Run the print head cleaning.

**Example of the nozzle check patterns with gloss black ink**

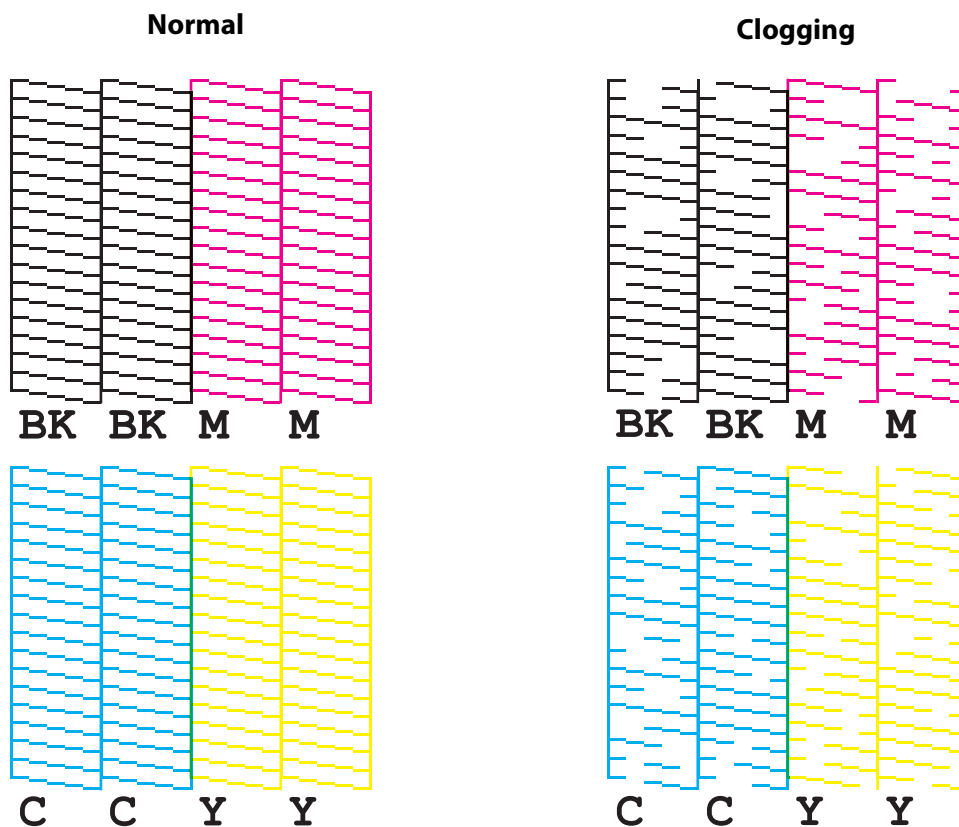

## Test Print using the Printer Driver

If you have already installed the printer driver, you can do a test print using the printer driver. Follow the procedure below to do the test print.

- 1 Open [Devices and Printers].
- 2 Right-click the icon of the printer, and then click [Printer properties].



This is how the screen appears if the name registered for the printer is EPSON CW-C6500Au.

- 3 The Printer properties screen appears. Click [Print Test Page] on the screen.

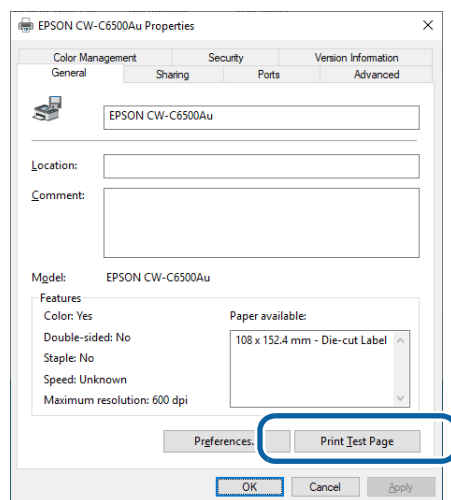

If the [Media Detect] setting has been set to [Gap], the test page is not printed from the first label. However, the auto cutter model can print from the first label if you do the settings described in the link below. ("[Printing from the First Label \(Auto cutter model only\)](#)" on page 288)

# Handling

This chapter provides basic information necessary for handling the printer.

## *Printer Driver for Windows*

This chapter describes how to operate the printer driver for Windows.

The printer driver is software to control the printer in accordance with the print instructions of application software. Setting the print settings in the printer driver screen enables you to obtain the best print results. Furthermore, you can also use the utilities to check the printer status and perform maintenance.

### Printer Driver

The printer driver print settings window is displayed.

**Method 1:** Windows Settings > printer management screen > [Print Settings]

**Method 2:** Windows Settings > printer management screen > [Printer Properties] > [General Settings] on the [General] tab

**Method 3:** Windows Settings > printer management screen > [Printer Properties] > [Printing Defaults] on the [Advanced] tab

**Method 4:** Application software print screen > [Printer Properties]

Any changes made to settings using either Method 1 or Method 2 will be specific to the user that is currently logged in.

Any changes made to settings using Method 3 will be applied to all users who use the printer. However, any settings that have been configured using either Method 1 or Method 2 will be given priority.

Any changes made to settings using Method 4 will be temporary.

If you want a value to be saved as a default setting, use either Method 1 or Method 2 to display and configure the printer driver.

The steps for opening the printer management screen from Windows Settings will vary depending on the version of Windows used.

## Printer Driver Screen Configuration

The printer driver is equipped with a help function. Right-click an item and then click Help to display an explanation on the item.

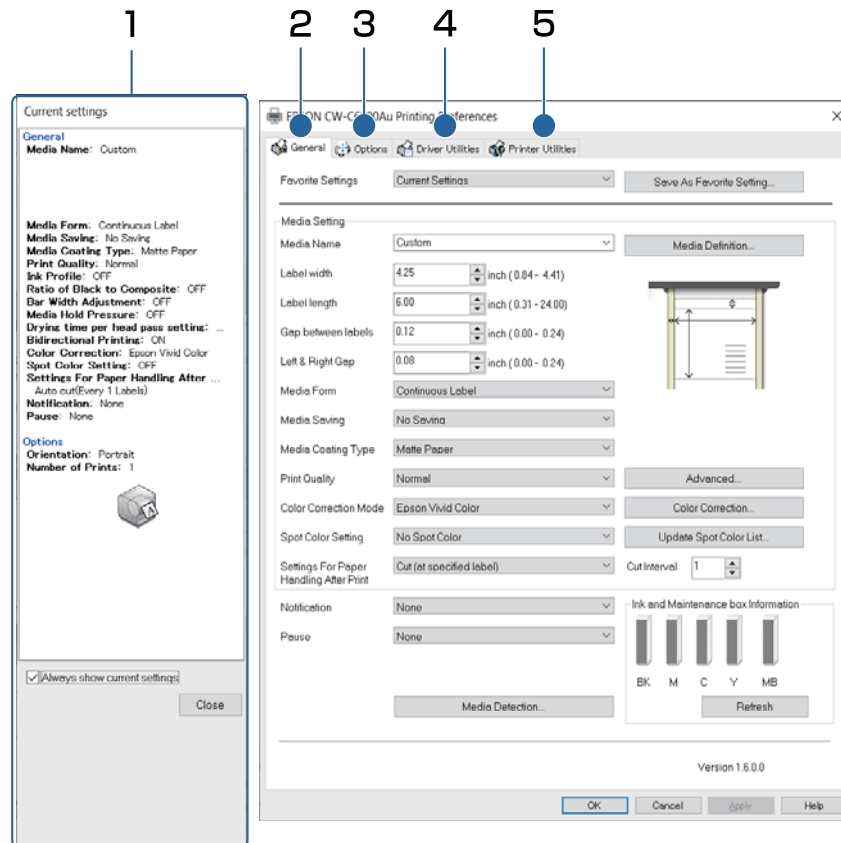

<b>1</b>	<b>Current Settings pane</b> Displays a summary of current settings.
<b>2</b>	<b>General tab</b> Lets you set media (paper) size, media form, and other basic print settings.
<b>3</b>	<b>Options tab</b> Print orientation and the number of copies can be set.
<b>4</b>	<b>Driver Utilities tab</b> Lets you configure various advanced settings.
<b>5</b>	<b>Printer Utilities tab</b> Lets you run printer maintenance functions such as print head cleaning or nozzle check, and start PrinterSetting.

## Media Setting

The following describes settings for the media on the printer driver.

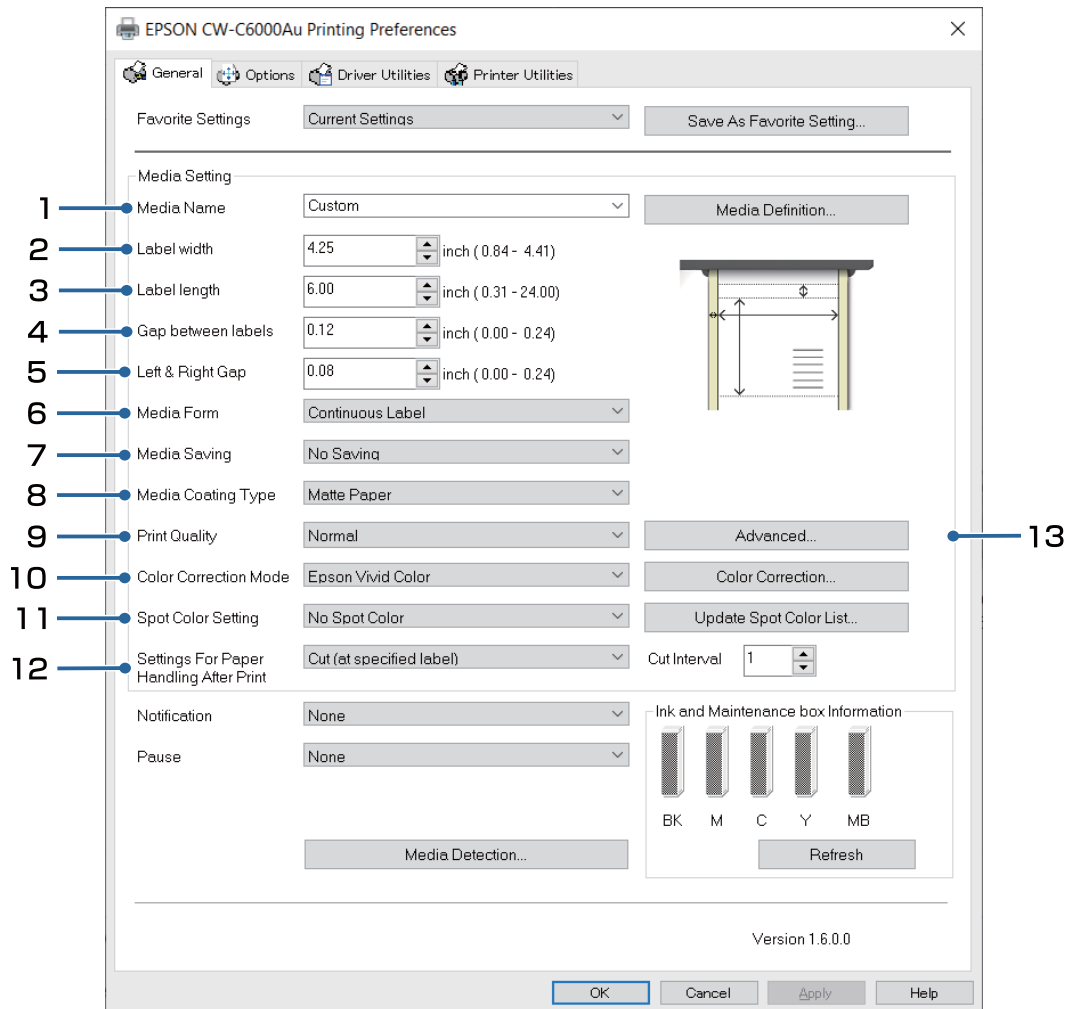

### 1 Media Name

You can select settings created in the user-defined paper settings. You can also select [Custom] to directly change the media settings.

**2 Label width**

Enter the width of the label.

- Continuous paper: Paper width



- Continuous label: Label width excluding the backing paper

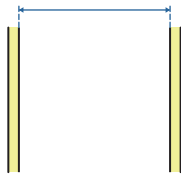

- Die-cut label: Label width excluding the backing paper

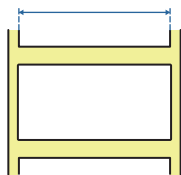

### 3 Label length

Enter the length of the label.

- Continuous paper, Continuous label: Length of the print range (length of one page)

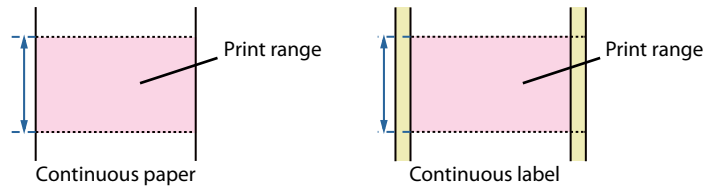

- Die-cut label: Label length excluding the backing paper

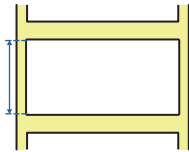

- If the interval for cutting the paper is less than 15.0 mm (0.59 inches), auto cutting is not possible because a paper jam may occur. If you want to use auto cutting for labels less than 15.0 mm (0.59 inches), set the interval for cutting the paper to 15.0 mm (0.59 inches) or more in the settings for paper handling after print. ("[Settings For Paper Handling After Print](#)" on page 83)
- Select the check box for [Banner Printing] on the [Options] tab to specify a label length up to 3000.0 mm (118.11 inches). This [Banner Printing] function is a processing function within the driver that divides the specified label length into multiple pages each having a length that is within the maximum label length that the printer can handle (609 mm (23.98 inches)) and prints them with a gap of 0 mm (0 inches) between the labels, so that labels longer than 609 mm (23.98 inches) can be printed.

### 4 Gap between labels

Enter the gap between labels.

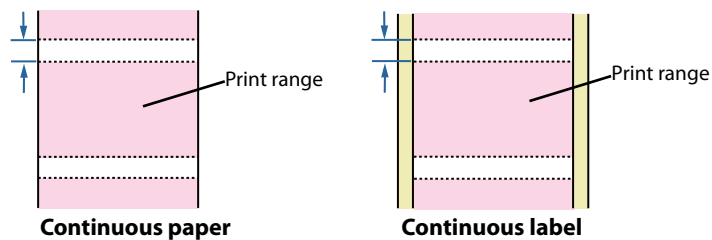

## 5 Left & Right Gap

The gaps on the left and right are always the same size. Therefore, a single value is entered for both the Left & Right Gap.

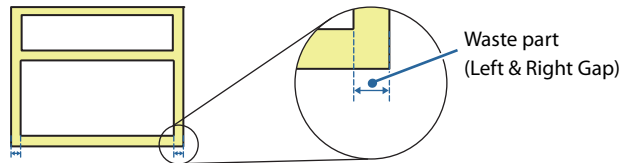

### IMPORTANT

- We recommend setting the Left & Right Gap to 2 mm (0.08 inches) or more. If it is set to less than 2 mm (0.08 inches), ink may adhere to the inside of the printer, staining printed material.
- Regarding the waste part on the left and right of the label  
 Auto cutter model: The waste parts can be set within a range of 2 to 6 mm (0.08 to 0.27 inches). (They should normally be set to 2 mm (0.08 inches).)  
 Peeler model: The waste parts can be set to 2 mm (0.08 inches) only.  
 \* If they are set larger than 2 mm (0.08 inches), problems such as paper jams might occur.

## 6 Media Form

Select the form of the paper. ("[Paper Specifications](#)" on page 361)

**7 Media Saving (for continuous paper and continuous label only)**

Select a media saving setting. The [Media Saving] function eliminates margins from one-page print data to suppress wasting paper.

**IMPORTANT**

Even if [Media Saving] is set to "Eliminate Lower Margin" or "Eliminate Lower and Upper Margin", the setting will be disabled when data for the barcode font replacement is included.



- No Saving: Paper is fed before starting printing and after completing printing, creating top and bottom margins on the printout.
- Eliminate Lower Margin: Paper is not fed after completing printing, and thus a lower margin is not created on the printout.
- Eliminate Lower and Upper Margin: Paper is not fed before starting printing or after completing printing, and thus lower and upper margins are not created on the printout.



If you set the printer to cut paper in the [Settings for Paper Handling After Print] setting, paper length of at least 15 mm (0.59 inches) is required. When the length of print data is less than 15 mm (0.59 inches), the margins are not eliminated even if you have set to [Eliminate Lower Margin] or [Eliminate Lower And Upper Margin].

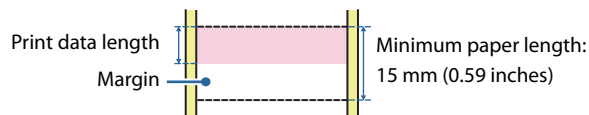

If your print data includes labels of various sizes, printing can be performed using label lengths optimized for the print data by setting the label (page) size to the largest value and then using the [Media Saving] function.

**8 Media Coating Type**

Select the media coating type. ("[Paper Specifications](#)" on page 361)

**9 Print Quality**

Select the print quality.

When [Media Coating Type] is [Plain Paper]

- Max Speed: 300 x 600 dpi
- Speed: 600 x 600 dpi (initial setting)
- Normal: 600 x 600 dpi
- Quality: 600 x 1200 dpi

When [Media Coating Type] is [Texture Paper], [Matte Paper], or [Synthetic]

- Max Speed: 300 x 600 dpi
- Speed: 600 x 600 dpi
- Normal: 600 x 600 dpi (initial setting)
- Quality: 600 x 1200 dpi

When [Media Coating Type] is [Glossy Paper], [Glossy Film], or [High Glossy Paper]

- Normal: 600 x 600 dpi
- Quality: 600 x 1200 dpi (initial setting)
- Max Quality: 1200 x 1200 dpi

**IMPORTANT**

Supported media coating types vary depending on which type of black ink, gloss black or matte black, is installed. For details, see ["Paper Specifications" on page 361](#).



If you change the [Media Coating Type] setting, the [Print Quality] setting will automatically be set to the initial setting suitable for the selected media coating type. Click [Advanced...] to configure more detailed print quality settings.

**10 Color Correction Mode**

Configure color correction settings. For more details about the color correction, see ["Color Correction" on page 274](#).

- Epson Vivid Color: The color correction engine inside the printer corrects the colors to vivid colors that are suitable for printing labels. As a result, the colors vary from that of a typical LCD monitor.
- Epson Preferred Color: The color correction engine in the printer corrects colors to produce print results that are close to those seen on a typical LCD monitor.
- ICM: The color correction engine inside the OS performs color correction according to the ICC profile corresponding to the set media coating type and print quality. The use of an appropriate ICC profile allows you to match the color of the LCD monitor and print result.
- None: Select this option when setting color correction on an application software. Color correction is not performed in the printer.

**11 Spot Color Setting**

Select a spot color setting file. For more details about the spot color setting, see ["Spot Color Settings" on page 268](#).

<b>12</b>	<b>Settings For Paper Handling After Print</b>
-----------	--

For the Auto Cutter Model

- Cut (after printing last label)
- Cut (at specified label)
- Cut (after last page of collate page)
- Do not cut (stop at cut position) (initial setting)
- Do not cut (stop at peel position)
- Do not cut (stop at the print end position)

For the Peeler Model

- Manual apply (Initial setting)
- Auto apply
- Rewind

**IMPORTANT**

- If you have set to [Cut (after last page of collate page)] and if the printer stops due to a paper jam or other reason while the auto cutter is operating after printing, it is impossible to resume printing.
- Cautions for when [Label length] is set to a value less than 15.0 mm (0.59 inches)
  - Auto cutting is not possible because a paper jam may occur.
  - You can select all three [Cut] options below in [Settings For Paper Handling After Print].
    - Cut (after printing last label)
    - Cut (at specified label)
    - Cut (after last page of collate page)
  - If you have selected [Cut (at specified label)] for [Settings For Paper Handling After Print] and selected the [Collate] check box on the [Options] tab, specify the number of pages per copy in [Cut Interval].  
If you have not selected the check box, we recommend specifying the number of copies in [Cut Interval].
  - When [Settings For Paper Handling After Print] - [Cut (at specified label)] - [Cut Interval] is set to "1", the driver automatically changes [Cut Interval] to "2" to reach or exceed the minimum label length that can be cut (15.0 mm (0.59 inches)).  
Also, to ensure that the label length does not become less than the minimum label length that can be cut (15.0 mm (0.59 inches)), "1" can no longer be set for [Cut Interval].

**13 Advanced**

Change the settings for color, barcode, and paper handling. For more details about each menu item, see the Help.

- **Print Color Adjustment**  
 Ink Profile: Print density can be changed to darker or lighter.  
 Ratio of Black to Composite: Adjust the ratio of black ink to composite black.
- **Barcode and 2D Symbol Preset**  
 Bar Width Adjustment: When using a built-in barcode font, adjust the bar width.
- **Paper Adjustment**  
 Media Hold Pressure: Adjust the paper suction power of the platen.  
 Drying time per head pass setting: Adjust additional time to dry ink.



- If you change the settings in [Print Color Adjustment], and/or [Bar Width Adjustment], it may affect readability of barcodes.
- If you increase the ratio of black ink in [Ratio of Black to Composite], be careful not to touch the label surface immediately after printing because ink can adhere to your fingers.

## Media Source and Media Detection Settings

- 1 Open the printer driver window.
- 2 Click [Media Detection...] on the General tab.

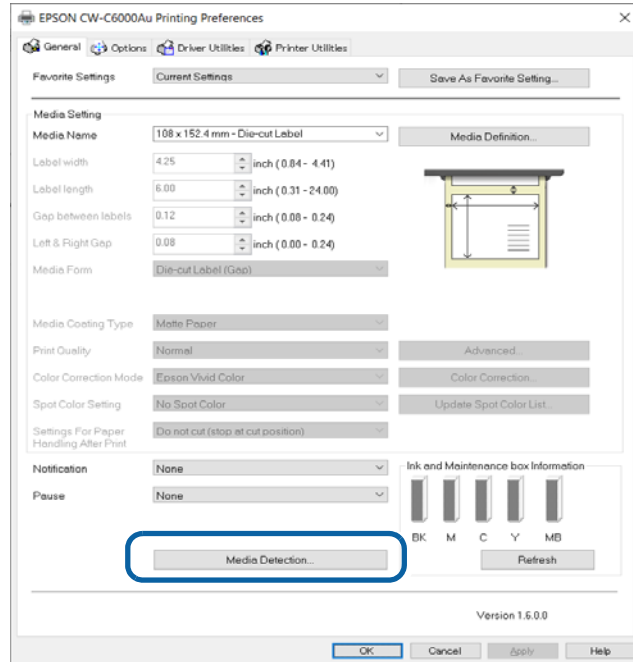

### 3 Make the following settings to match them with the paper you use.

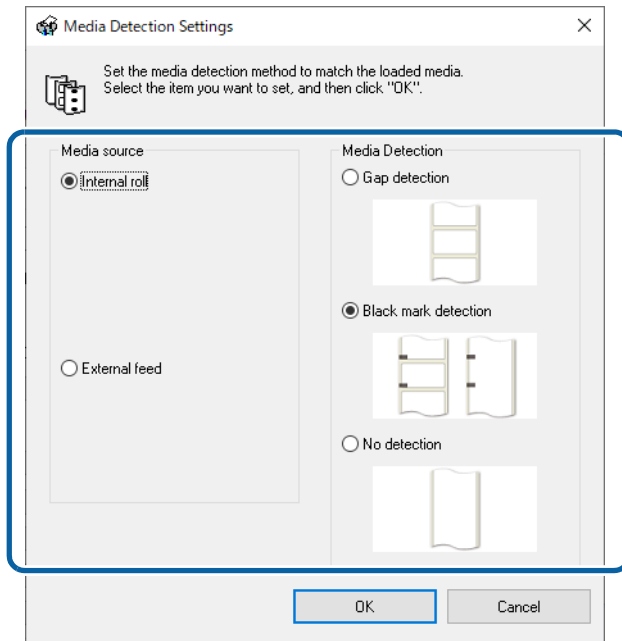

- Media Source: Select how to supply paper to the printer.

Setting item	Description
Internal roll (supply from inside)	Paper is supplied from inside the printer. Set roll paper attached to the spindle into the printer.
External feed (supply from outside)	Paper is supplied from outside the printer. Place roll paper or fanfold paper behind the printer.

- Media Detection: Select how to detect print positions.

Setting item	Description
Gap detection	The print position is detected based on the gaps between labels.
Black mark detection	The print position is detected based on the black marks printed on the back or backing paper of the paper.
No detection	Print position detection using gaps or black marks is not performed.

- 4 Click [OK].**  
Media source and media detection settings are now complete.

## User-Defined Paper

The size, form, type, and other settings of frequently used paper can be registered to the printer driver as a media definition. This is convenient because you will not need to set the paper settings of the driver when printing from an application if you register a media definition in advance.



If you wish to set the paper size and other settings every time without registering a media definition, select [Custom] from the [Media Name] pull-down menu on the [General] tab. The various settings on the [General] tab will become available so that you can set the paper size and other settings.

## Registering New

Register a new media definition by following the steps below.

- 1 Open the printer driver window.**
- 2 Click the [Media Definition] button on the [General] tab.**  
The Media Definition screen appears.

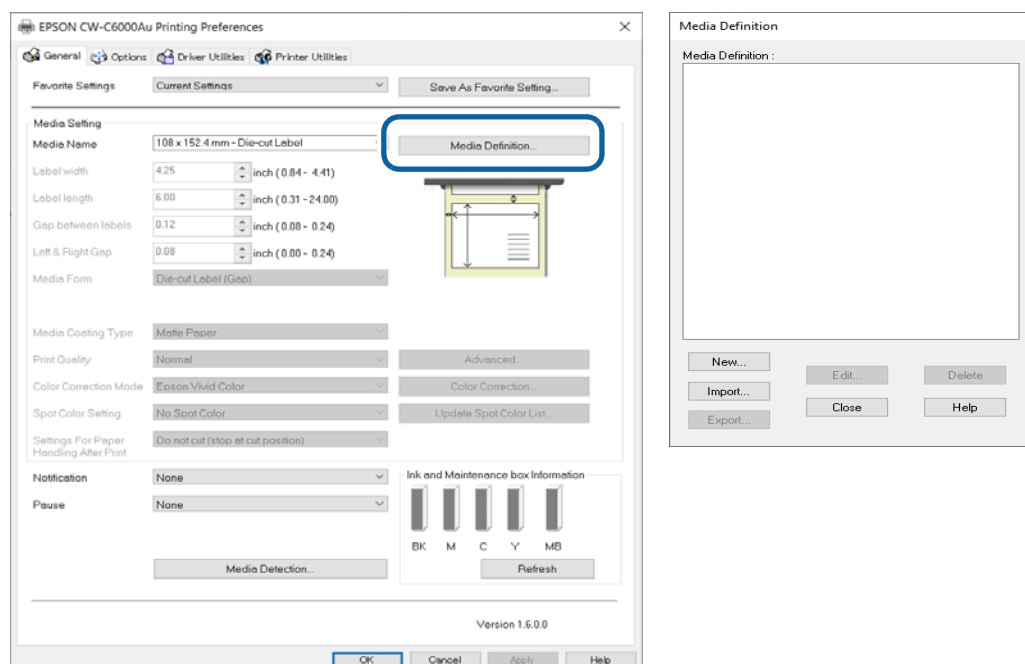

- 3** Click the [New] button.  
The New screen appears.

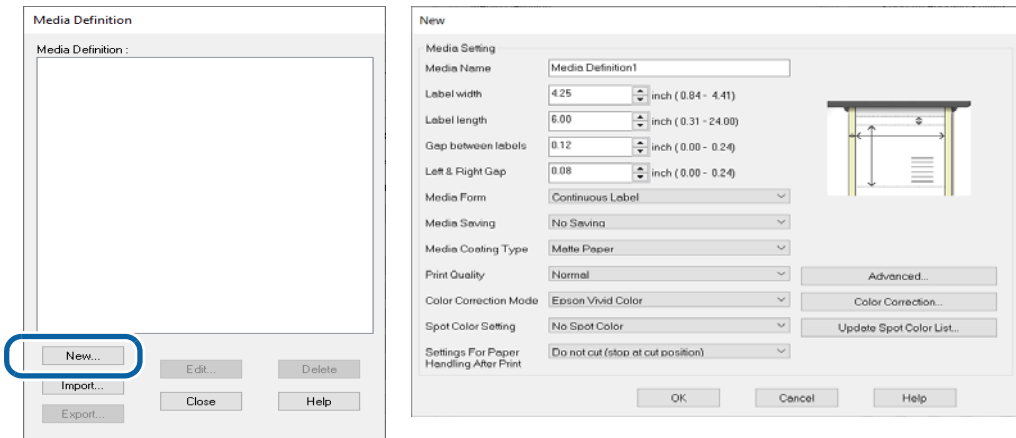

- 4** Make settings to match the paper you use.  
Enter the name of the media definition in [Media Name]. This is the name displayed when you select a paper size from an application. For an explanation of the other items, see "[Media Setting](#)" on page 77.

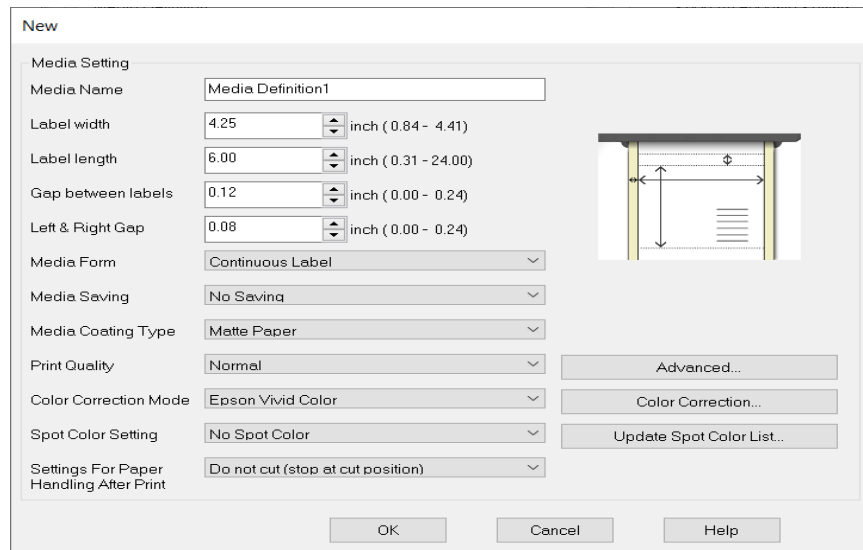

## 5 Click [OK].

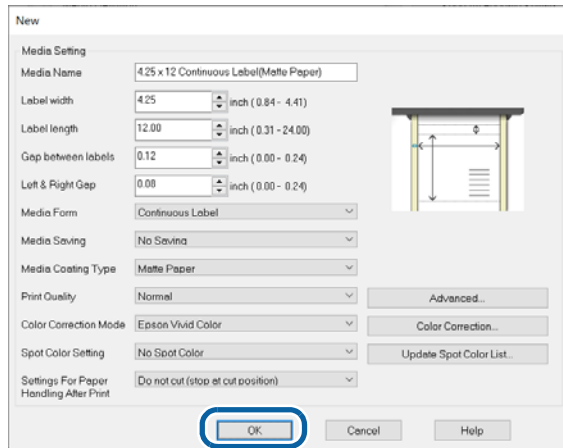

## 6 Check that the registered media name is displayed in the Media Definition screen and then click [Close].

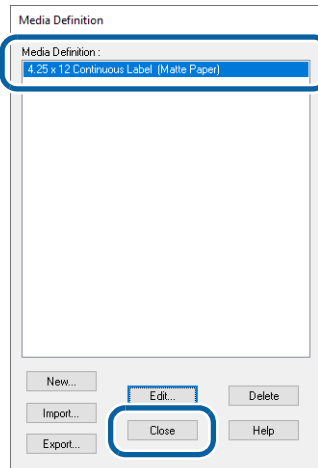

## 7 Check that you can select the registered media name in [Media Name] on the [General] tab.



## 8 Click the [OK] button to close the driver.

Paper registration (media definition) is now complete.

## Editing and Deleting

- 1 Open the printer driver window.
- 2 Click the [Media Definition] button on the [General] tab.  
The Media Definition screen appears.

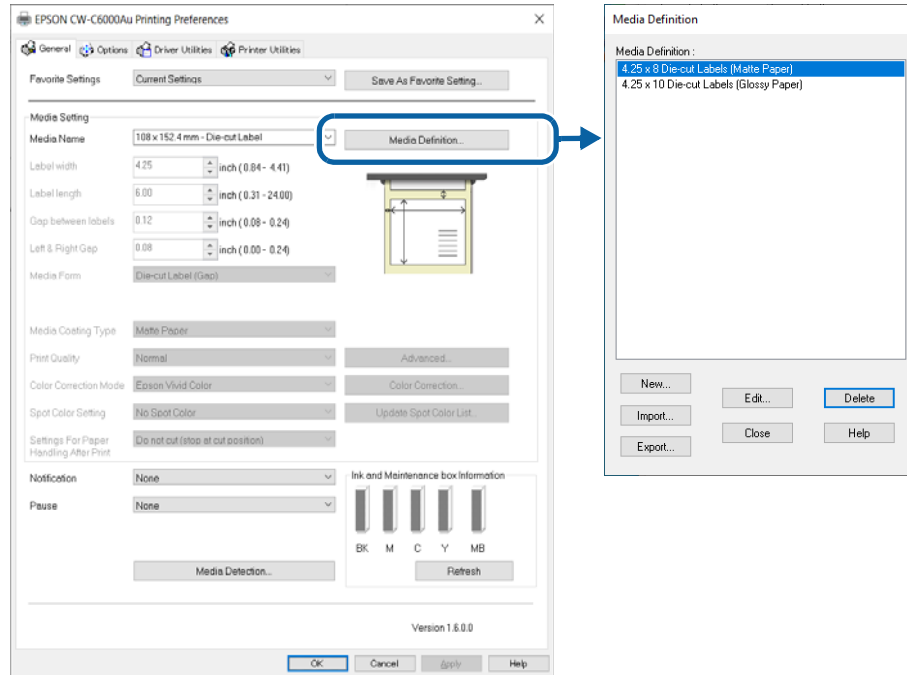

- 3 Click to select the media definition you wish to edit or delete.

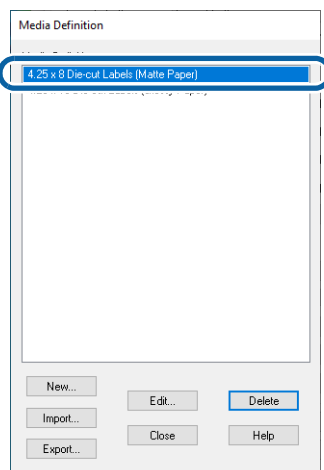

- 4** If you wish to change the definition settings, click the [Edit] button. The Edit screen appears and you can change the definition.

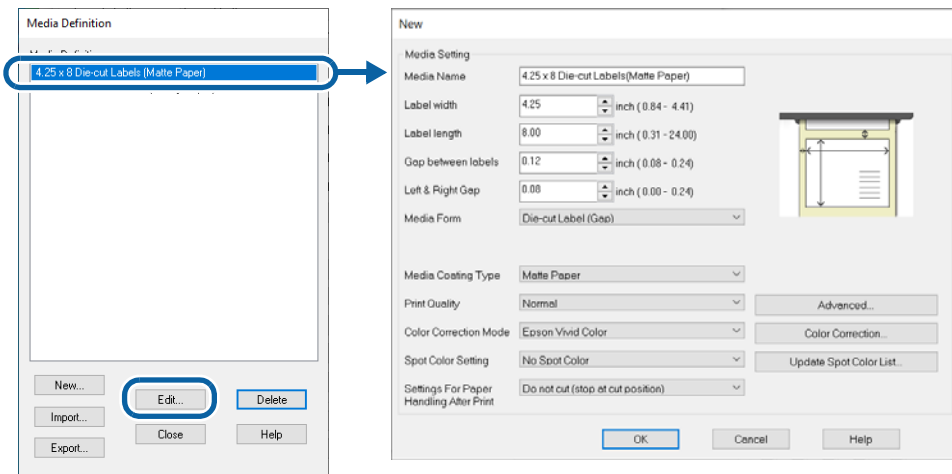

If you wish to delete the definition, click the [Delete] button. A screen appears and if you click the [OK] button, the definition is deleted.

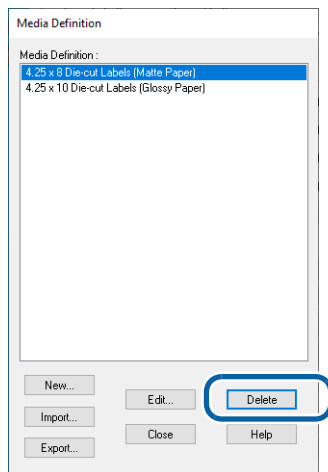

Editing or deleting a media definition is now complete.

## Banner Printing

This product can use the Banner Printing function. Banner Printing divides the specified label length into multiple pages each having a length that is within the maximum label length that the printer can handle (609 mm (23.98 inches)) and prints them with a gap of 0 mm (0 inches) between pages, so that labels longer than 609 mm (23.98 inches) can be printed.



- If you enabled [Shared Print mode] and then performed Banner Printing from a 32-bit Windows client PC, printing may be terminated before it is finished. ("[Sharing the Printer Driver](#)" on page 134)
- This function divides the specified label length into multiple pages each having a length that is within the maximum label length that the printer can handle (609 mm (23.98 inches)) and prints them with a gap of 0 mm (0 inches) between pages. Therefore, the image quality may decrease where pages are connected, and the connections may be noticeable.

## Banner Printing Settings

### 1 In the [General] tab, select the following papers for [Media Form].

- Continuous label
- Continuous paper

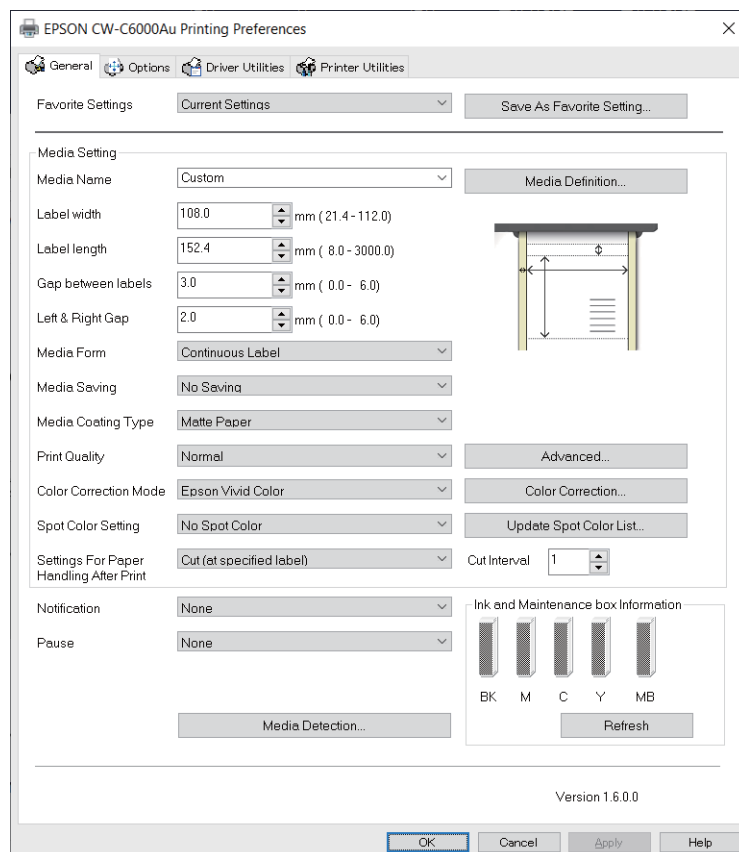

## 2 Select the check box for [Banner Printing] on the [Options] tab.

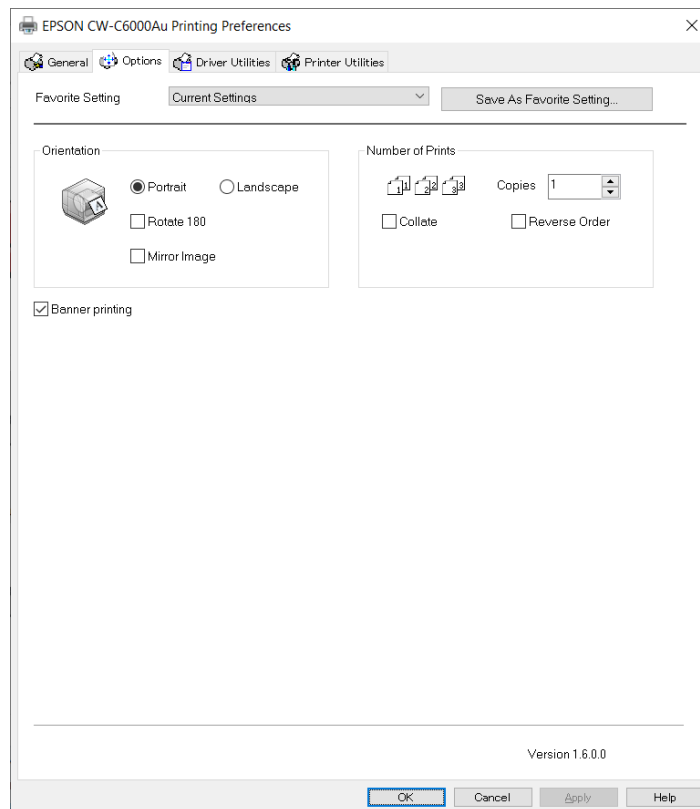

## 3 Check that you can enter up to 3000.0 mm (118.11 inches) for [Label length] on the [General] tab.

## 4 Enter the length of the label to be printed in [Label length].

## Printing Barcodes

The printer has built-in fonts. This allows you to print a barcode without creating it on an application software.

### Barcode Font Settings

You can make the barcode settings using [Barcode and 2D Symbol Settings] on the [Driver Utilities] tab.

#### 1 Make the following settings.

- Display: Select [Barcodes].
- Font Name: Enter a character string. The string is set as the barcode font name. Only ASCII characters are accepted.
- Type: Select a barcode type. Available setting items changes according to the selected barcode type. You can select the type from the following options.

UPC-A	UPC-E	JAN13(EAN)
JAN8(EAN)	Code39	ITF
Codabar(NW7)	Code93	Code128
GS1-128	GS1 DataBar Omnidirectional	GS1 DataBar Truncated
GS1 DataBar Limited	GS1 DataBar Expanded	

- **Rotation Settings:** Select an option to rotate a barcode.
- **Hexadecimal Input Mode:**  
Select the check box to enter data for a barcode in hexadecimal.
- **Module:** Specify the width of the narrowest element of the barcode in units of dot.
- **Bar Height:** Specify the height of the element in units of dot. Actual print size equivalent to the specified dots will be displayed.
- **HRI Character Position:**  
Specify the position to print HRI characters. Select [Do Not Print] if printing HRI characters is not necessary.



Depending on the selected barcode type, the position option cannot be selected.

- **Composite Component:**  
Select a composite type.
- **Element Ratio:** Specify the ratio of wide element width to the narrowest element width.  
The recommended ratio is 2.5.
- **Check Digit:** A number or symbol added to the barcode number in order to detect an error in the barcode number and to prevent fabrication.
- **Auto Convert to Minimize Entire Symbol Width:**  
You can select this when the barcode type is CODE128. This function minimizes the number of symbols and characters that are necessary to express the specified data string.
- **Start Character:** Specify the start character.
- **Stop Character:** Specify the stop character.
- **Margin Settings:** The background of the barcode is transparent. If you select the checkbox for “Margin Settings”, the barcode is printed with the transparent background filled in white.  
The amount of margin can be set for [Top Margin], [Left Margin], [Bottom Margin], and [Right Margin] respectively.

## 2 Click [Add].

The configured barcode font is registered and added to the font list.



- Up to 30 barcode fonts can be registered.
- To edit settings of a registered barcode font, select the font from the font list, change the settings and then click [Save].
- To delete a registered barcode font, select the font from the font list, and then click [Delete].

## Recommended Module Values

Print directions of a barcode are as shown below. The recommended module values vary by paper type, barcode type, and the print direction.

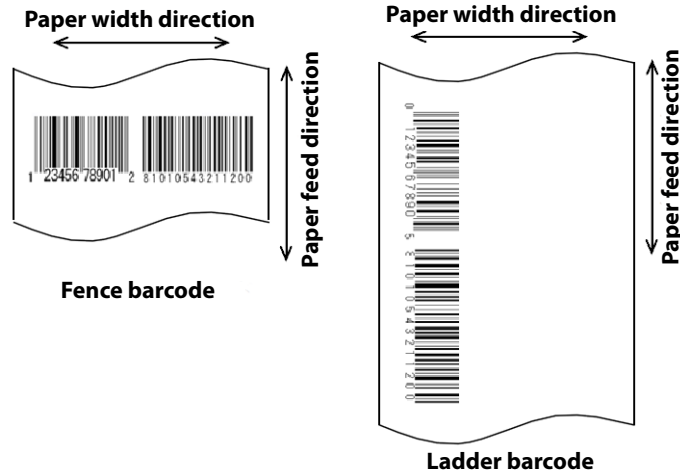

 <b>WARNING</b>	If [Rotation Settings] is set to [Normal] or [Rotate 270 Degrees], the barcode is not be printed.
--	---

□ 300 dpi

Barcode	Orientation	Minimum module size [in units of 300 dpi]					
		ANSI Grade D or higher	ANSI Grade C or higher				
		Plain Paper	Matte Paper	Synthetic	Glossy Paper	Glossy Film	High Glossy Paper
Code39	Fence	4	3	3	3	3	3
	Ladder	5	3	3	3	3	3
Codabar	Fence	4	3	3	3	3	3
	Ladder	5	3	3	3	3	3
Code93	Fence	4	3	3	3	3	3
	Ladder	5	3	3	3	3	3
Code128	Fence	4	3	3	3	3	3
	Ladder	5	3	3	3	3	3
GS1-128	Fence	4	3	3	3	3	3
	Ladder	5	3	3	3	3	3

Barcode	Orientation	Minimum module size [in units of 300 dpi]					
		ANSI Grade D or higher	ANSI Grade C or higher				
		Plain Paper	Matte Paper	Synthetic	Glossy Paper	Glossy Film	High Glossy Paper
ITF	Fence	4	3	3	3	3	3
	Ladder	5	3	3	3	3	3
GS1 DataBar Omnidirectional	Fence	4	3	3	3	3	3
	Ladder	5	3	3	3	3	3
GS1 DataBar Truncated	Fence	4	3	3	3	3	3
	Ladder	5	3	3	3	3	3
GS1 DataBar Limited	Fence	4	3	3	3	3	3
	Ladder	5	3	3	3	3	3
GS1 DataBar Expanded	Fence	4	3	3	3	3	3
	Ladder	5	3	3	3	3	3
UPC-A	Fence	4	3	3	3	3	3
UPC-E	Ladder	5	3	3	3	3	3
JAN13	Fence	4	3	3	3	3	3
JAN8	Ladder	5	3	3	3	3	3
EAN13	Fence	4	3	3	3	3	3
EAN8	Ladder	5	3	3	3	3	3

□ 600 dpi

Barcode	Orientation	Minimum module size [in units of 600 dpi]					
		ANSI Grade D or higher	ANSI Grade C or higher				
		Plain Paper	Matte Paper	Synthetic	Glossy Paper	Glossy Film	High Glossy Paper
Code39	Fence	7	5	5	5	5	5
	Ladder	10	6	5	6	6	6
Codabar	Fence	7	5	5	5	5	5
	Ladder	10	6	5	6	6	6
Code93	Fence	7	5	5	5	5	5
	Ladder	10	6	5	6	6	6

Barcode	Orientation	Minimum module size [in units of 600 dpi]					
		ANSI Grade D or higher	ANSI Grade C or higher				
			Plain Paper	Matte Paper	Synthetic	Glossy Paper	Glossy Film
Code128	Fence	7	5	5	5	5	5
	Ladder	10	6	5	6	6	6
GS1-128	Fence	7	5	5	5	5	5
	Ladder	10	6	5	6	6	6
ITF	Fence	7	6	6	6	6	6
	Ladder	10	6	6	6	6	6
GS1 DataBar Omnidirectional	Fence	7	6	6	6	6	6
	Ladder	10	6	6	6	6	6
GS1 DataBar Truncated	Fence	7	6	6	6	6	6
	Ladder	10	6	6	6	6	6
GS1 DataBar Limited	Fence	7	6	6	6	6	6
	Ladder	10	6	6	6	6	6
GS1 DataBar Expanded	Fence	7	6	6	6	6	6
	Ladder	10	6	6	6	6	6
UPC-A	Fence	7	7	7	7	7	7
UPC-E	Ladder	10	7	7	7	7	7
JAN13	Fence	7	7	7	7	7	7
JAN8	Ladder	10	7	7	7	7	7
EAN13	Fence	7	7	7	7	7	7
EAN8	Ladder	10	7	7	7	7	7



- Readability of a barcode varies by paper type, performance of a barcode reader, or other factors. Furthermore, drop in print quality due to clogging of print head nozzles or skew of ink drops can cause a barcode to become unreadable. In case it happens, it is recommended to print HRI characters or take other measures.
- Due to the characteristics of the ink, printing a barcode onto paper which ink has seeped into may cause the bar width of the barcode to become thicker, impacting the barcode rank. Reducing the bar width of the barcode may improve the barcode rank. When using a built-in barcode font, use the [Bar Width Adjustment] function to perform adjustments.
- If vibrations or shocks are applied to the printer during transporting or installing the printer, it may cause drop in barcode rank. In that happens, barcode rank may improve by carrying out [Bi-directional Printing Adjustment]. ("[Vertical Alignment](#)" on page 209)

## How to Specify Barcode Data

See the following descriptions to specify barcode data.

About the composite symbol:

Switching between CC-A and CC-B is automatically performed, however, to use CC-C, you need to specify to use it.

(For GS1-128, the type of composite component can be selected from [No composite], [CC-A/CC-B], and [CC-C].)

Composite component type	Encodable number of digits
CC-A	1 to 56 digits
CC-B	1 to 338 digits
CC-C	1 to 2361 digits

About HRI characters:

If the length of the HRI characters becomes wider than entire width of the barcode, the length is regarded as the barcode width.

### UPC-A

- Specify the barcode data with 11 digits. A check digit will be automatically added.

### UPC-E

- Specify the barcode data with 10 digits. 5 digits are for a manufacturer code, and the rest of 5 digits are for a product code.

### JAN13(EAN)

- Specify the barcode data with 12 digits. A check digit will be automatically added.

### JAN8(EAN)

- Specify the barcode data with 7 digits. A check digit will be automatically added.

### Code39

- If both or either one of a start code or a stop code is not specified, they will be automatically added.

### ITF

- If specified with an odd number of digits, "0" (zero) will be automatically added at the beginning of the digits.

### Codabar(NW7)

- Do not include a start code and a stop code. The start code and stop code you specified on the printer driver will be added.

### Code93

- A start code, two check digits, and a stop code will be automatically added.
- A character (□) that indicates a start code is printed at the beginning of the HRI characters.
- A character (□) that indicates a stop code is printed at the end of the HRI characters.
- A combination of ■ and an alphabet character is printed to express each of HRI control characters (00h to 1Fh, 7Fh).

Control character		HRI character	Control character		HRI character	Control character		HRI character
ASCII	Hex number		ASCII	Hex number		ASCII	Hex number	
NULL	00	■ U	VT	0B	■ K	SYN	16	■ V
SOH	01	■ A	FF	0C	■ L	ETB	17	■ W
STX	02	■ B	CR	0D	■ M	CAN	18	■ X
ETX	03	■ C	SO	0E	■ N	EM	19	■ Y
EOT	04	■ D	SI	0F	■ O	SUB	1A	■ Z
ENQ	05	■ E	DLE	10	■ P	ESC	1B	■ A
ACK	06	■ F	DC1	11	■ Q	FS	1C	■ B
BEL	07	■ G	DC2	12	■ R	GS	1D	■ C
BS	08	■ H	DC3	13	■ S	RS	1E	■ D
HT	09	■ I	DC4	14	■ T	US	1F	■ E
LF	0A	■ J	NAK	15	■ U	DEL	7F	■ F

## Code128

- If you have disabled the auto convert function, enter a two-digits start code at the beginning of the data. If you have enabled the auto convert function, the type of start character is automatically determined and you do not need to specify the type in your application.
  - An error will occur if you add {A, which sets the type to CODE A, when CODE A has already been selected as the start character.
  - An error will occur if you add {B, which sets the type to CODE B, when CODE B has already been selected as the start character.
  - An error will occur if you add any one of the following characters when CODE C has already been selected as the start character.  
 {S {2 {3 {4 {{
- A special character is expressed by a combination of { and the next character.

Control character	ASCII	HRI character
SHIFT	{S	Not printed
CODE A	{A	Not printed
CODE B	{B	Not printed
CODE C	{C	Not printed
FNC1	{1	Not printed
FNC2	{2	Not printed
FNC3	{3	Not printed
FNC4	{4	Not printed
{	{{	{ is printed.

**GS1-128**

- ‘()’ are used as delimiters for the application identifiers. (printed as the HRI character, but not encoded.)
- A start code (CODE A, CODE B, CODE C) and a stop code will be automatically added.
- A symbol character FNC1 is automatically added next to the start code.
- If you use “\*”, it will be skipped.
- As an application identifier, specify a two-digits consecutive number. If the identifier is not specified correctly, an error will occur.
- A special character is expressed by a combination of { and the next character.
- If data immediately after { does not apply to any one of the followings, an error will occur.

Control character	ASCII	HRI character
Control character (00h to 1Fh, and 7Fh)		A space is printed.
FNC1	{1	A space is printed.
{	{{	{ is printed.
{(	{{(	( is printed.
{)}	{{)}	) is printed.
{*}	{{*}	* is printed.
Beginning parenthesis for an application identifier	(	( is printed.
Closing parenthesis for an application identifier	)	) is printed.
Skipped character	*	Not printed

**GS1 DataBar Omnidirectional / GS1 DataBar Truncated / GS1 DataBar Limited**

- The first “01”, an application identifier, is not encoded (not included as the barcode data).
- When the HRI character is printed, the application identifier 01 is printed as “(01)” before the package identification code.
- You do not need to add a check digit in the barcode data.
- When the HRI character is printed, a check digit will be automatically printed after the product code.
- For GS1 DataBar Limited, specify 0 or 1 for the first digit.

## GS1 DataBar Expanded

- ‘(’ are used as delimiters for the application identifiers. (printed as the HRI character, but not encoded.)
- Be sure to include all the application identifiers in the data.
- If the first data is “01” when an application identifier, left and right parentheses, and \* are excluded, the 14th digit counted from the digit next to “01” is used as the check digit. If the data is incorrect, an error will occur.
- If the number of digits after “01” is less than 14, a check digit is not added.  
(Unlike GS1-128, a symbol “\*” cannot be used for automatic calculation and addition of a check digit. If “\*” is added in the data, it will be ignored and the subsequent data is shifted by one digit.)
- Specify a special character as described below.

Control character	ASCII	HRI character
FNC1	{1	Not printed
Beginning parenthesis for an application identifier	(	( is printed.
Closing parenthesis for an application identifier	)	) is printed.
'*'	{*	Error
Skipped character	*	Not printed
'{'	{{	{ is printed.

---

## How to Print

Open print data file in an application, and specify barcode font, point, and language that you have set on the printer driver, and then print it.



- The barcode size cannot be changed from the point set in [Specified Point]. If you specify a size other than the specified one, the barcode is not printed.
- Some application such as .NET application may not be able to display or let you select the barcode font registered by the printer driver. If that occurs, use the [Font Replacement] function of the printer driver to replace a True Type font with the barcode font. See ["Printing Barcodes / 2D Symbols on .NET Environment" on page 113](#).

## Printing 2D Symbols

The printer driver has the built-in 2D symbol font. This allows you to print a 2D symbol without creating it on an application software.

### Setting the 2D Symbol Font

You can make the 2D symbol settings using [Barcode and 2D Symbol Settings] on the [Driver Utilities] tab.

#### 1 Make the following settings.

- Display: Select [2D Symbols].
- Font Name: Enter a character string. The string is set as the 2D symbol font name. Only ASCII characters are accepted.
- Type: Select a type of 2D symbol. Available setting items changes according to the selected type.
- Rotation Settings: Select an option to rotate a 2D symbol.
- Hexadecimal Input Mode: Select the check box to enter data for a 2D symbol in hexadecimal.
- Margin Settings: The background of 2D Symbols is transparent. If you select the checkbox for “Margin Settings”, the barcode is printed with the transparent background filled in white.  
The amount of margin can be set for [Top Margin], [Left Margin], [Bottom Margin], and [Right Margin] respectively.

## 2 Make the settings for the barcode type you selected.

- Settings for PDF417
  - \* Module Width: Set module width of PDF417.  
For the recommended value, see ["Recommended Module Values" on page 108.](#)
  - \* Module Height: Specify the ratio of PDF417 module height to the module width.  
For the recommended value, see ["Recommended Module Values" on page 108.](#)
  - \* Column: Specify the number of columns of PDF417.
  - \* Row: Specify the number of rows of PDF417.
  - \* Truncation Symbol: Select the check box to create a symbol using data excluding the stop code of PDF417.
  - \* Error Correction Level: Specify an error correction level for PDF417. This allows the symbol data to be correctly read even if a portion of the symbol is missing or damaged. The larger the number is, the higher the possibility of data restoration gets.
- Settings for MicroPDF417
  - \* Module Width: Set module width of MicroPDF417.  
For the recommended value, see ["Recommended Module Values" on page 108.](#)
  - \* Module Height: Specify the ratio of MicroPDF417 module height to the module width.  
For the recommended value, see ["Recommended Module Values" on page 108.](#)
  - \* Column: Specify the number of columns of MicroPDF417.
  - \* Row: Specify the number of rows of MicroPDF417.
- Settings for QR code
  - \* Model: Select a QR code model.
  - \* Module: Select a width of a cell (module) of QR code.  
For the recommended value, see ["Recommended Module Values" on page 108.](#)
  - \* Error Correction Level: Specify an error correction level for QR code. This allows the symbol data to be correctly read even if a portion of the symbol is missing or damaged. The possibility of data restoration gets higher in the order of L, M, Q, and H.
  - \* Character Mode: Select a mode for data to be converted into a QR code.
- Settings for Micro QR code
  - \* Version: Specify the version of Micro QR code.
  - \* Module: Select a width of a cell (module) of Micro QR code.  
For the recommended value, see ["Recommended Module Values" on page 108.](#)
  - \* Error Correction Level: Specify an error correction level for Micro QR code. This allows the symbol data to be correctly read even if a portion of the symbol is missing or damaged. The possibility of data restoration gets higher in the order of L, M.
- Settings for MaxiCode
  - \* Mode: Select a mode of MaxiCode.
- Settings for GS1 DataBar
  - \* Module: Set module width of GS1 DataBar.  
For the recommended value, see ["Recommended Module Values" on page 108.](#)
  - \* Number of Characters: Specify the max width of GS1 DataBar.  
Set this if you have selected GS1 DataBar Expanded Stacked.

- Settings for AztecCode
  - \* Type: Select a type of AztecCode.
  - \* Cell Size: Select a size of a cell (module) of AztecCode.  
For the recommended value, see "[Recommended Module Values](#)" on page 108.
  - \* Number of Layers: Specify the number of layers of AztecCode.
  - \* Error Correction Area:
    - Select any one of the following error correction area settings for AztecCode. This allows the symbol data to be correctly read even if a portion of the symbol is missing or damaged. The larger the number is, the higher the possibility of data restoration gets.
    - [Auto]: the default is 23%+3 code words.
    - [Specify a Percentage]: Enter a percentage of error correction area into the entry field.
- Settings for DataMatrix
  - \* Symbol Shape: Select a shape of DataMatrix symbol.
  - \* Error Correction Level:
    - Specify an error correction level for DataMatrix.
  - \* Cell Size: Select a size of a cell (module) of DataMatrix.  
For the recommended value, see "[Recommended Module Values](#)" on page 108.
  - \* Number of Vertical Cells:
    - Specify the number of cells of DataMatrix in the vertical direction.
    - Set this when you have selected [Rectangle] in the DataMatrix [Symbol Shape] setting.
  - \* Number of Horizontal Cells:
    - Specify the number of cells of DataMatrix in the horizontal direction.
    - Set this when you have selected [Rectangle] in the DataMatrix [Symbol Shape] setting.
    - [Minimize]: The number of cells is automatically optimized and minimized.
    - [Specify the Size]: The number of cells is set according to the selected size.

### 3 Click [Add].

The configured 2D symbol font is registered and added to the font list.



- Up to 30 2D symbol fonts can be registered.
- To edit settings of a registered 2D symbol font, select the font from the font list, change the settings and then click [Save].
- To delete a registered 2D symbol font, select the font from the font list, and then click [Delete].

## Recommended Module Values

The recommended module values vary by paper type, 2D symbol type, and the print direction.



- You cannot change the orientation of a QR code, Micro QR code, and Maxi code by setting [Orientation] on the [Options] tab to [Landscape].
- You cannot rotate a QR code, Micro QR code, and Maxi code by selecting [Rotate 180] on the [Options] tab. In addition, if [Rotation Settings] is set to [Normal] or [Rotate 270 Degrees], the 2D symbol is not be printed.

### 2D Symbols - Stacked code type

□ 300 dpi

2D Symbols	Orientation	Minimum module size [in units of 300 dpi]					
		ANSI Grade D or higher	ANSI Grade C or higher				
		Plain Paper	Matte Paper	Synthetic	Glossy Paper	Glossy Film	High Glossy Paper
PDF417	-	5	3	3	3	3	3
Micro PDF	-	5	3	3	3	3	3
GS1 DataBar Stacked	-	5	3	3	3	3	3
GS1 DataBar Stacked Omnidirectional	-	5	3	3	3	3	3
GS1 DataBar Expanded Stacked	-	5	3	3	3	3	3

□ 600dpi

2D Symbols	Orientation	Minimum module size [in units of 600 dpi]					
		ANSI Grade D or higher	ANSI Grade C or higher				
		Plain Paper	Matte Paper	Synthetic	Glossy Paper	Glossy Film	High Glossy Paper
PDF417	-	10	5	5	5	5	5
Micro PDF	-	10	5	5	5	5	5
GS1 DataBar Stacked	-	10	5	5	5	5	5

2D Symbols	Orientation	Minimum module size [in units of 600 dpi]					
		ANSI Grade D or higher	ANSI Grade C or higher				
		Plain Paper	Matte Paper	Synthetic	Glossy Paper	Glossy Film	High Glossy Paper
GS1 DataBar Stacked Omnidirectional	-	10	5	5	5	5	5
GS1 DataBar Expanded Stacked	-	10	5	5	5	5	5



- If vibrations or shocks are applied to the printer during transporting or installing the printer, it may cause drop in barcode rank. In that happens, barcode rank may improve by carrying out [Bi-directional Printing Adjustment]. ("[Vertical Alignment](#)" on page 209)

## 2D Symbols - Matrix code type

□ 300 dpi

2D Symbols	Orientation	Minimum module size [in units of 300 dpi]					
		ANSI Grade D or higher	ANSI Grade C or higher				
		Plain Paper	Matte Paper	Synthetic	Glossy Paper	Glossy Film	High Glossy Paper
QR Code	-	7	4	5	5	5	5
Micro QR	-	7	5	6	5	5	5
Aztec	-	7	4	4	4	4	4
DataMatrix	-	7	3	4	3	3	3
MaxiCode	-	21	21	21	21	21	21

□ 600dpi

2D Symbols	Orientation	Minimum module size [in units of 600 dpi]					
		ANSI Grade D or higher	ANSI Grade C or higher				
		Plain Paper	Matte Paper	Synthetic	Glossy Paper	Glossy Film	High Glossy Paper
QR Code	-	13	9	10	9	9	9
Micro QR	-	13	11	12	11	11	11
Aztec	-	13	8	8	8	8	8
DataMatrix	-	13	7	8	7	7	7
MaxiCode	-	21	21	21	21	21	21



- If vibrations or shocks are applied to the printer during transporting or installing the printer, it may cause drop in barcode rank. In that happens, barcode rank may improve by carrying out [Bi-directional Printing Adjustment]. ("[Vertical Alignment](#)" on page 209)

## Specifying Data of 2D Symbols

See the following descriptions to specify 2D symbol data.

### PDF417 / MicroPDF417

- If the number of columns and rows is 0, they are automatically calculated.
- When specifying a number other than 0, specify the numbers so that multiplying the columns by the rows equals 928 or lower.

### QR Code

- According to the data size, the version is automatically changed to the version appropriate to the size.

### Micro QR Code

- The size is automatically determined.

### MaxiCode

- Specify a special character as described below.

Control character	Hexadecimal
SHIFT	0x7B, 0x53
CODE B	0x7B, 0x42
CODE C	0x7B, 0x43
FNC1	0x7B, 0x31
FNC2	0x7B, 0x32
FNC3	0x7B, 0x33
FNC4	0x7B, 0x34

### DataMatrix

- If data immediately after { does not apply to any one of the followings, an error will occur.

Control character	ASCII
FNC1	{1
'{'	{{

### GS1 DataBar Stacked / GS1 DataBar Stacked Omnidirectional

- Do not include the application identifier "01" in the beginning of data.
- You do not need to add a check digit in the data.
- Printing the 2D symbol with a composite symbol is supported. When printing the 2D symbol with a composite symbol, use "\|" or "|\" to separate the barcode data from the data for the composite symbol. First enter data for the composite symbol, then enter data for the 2D symbol.

## GS1 DataBar Expanded Stacked

- Multiple GS1 DataBar Expanded barcodes can be stacked. The way to specify the data is the same with that for GS1 DataBar Expanded. For details, see "[GS1 DataBar Expanded](#)" on page 103.
- Printing the 2D symbol with a composite symbol is supported. When printing the 2D symbol with a composite symbol, use “\|” or “|\” to separate the barcode data from the data for the composite symbol. First enter data for the composite symbol, then enter data for the 2D symbol.

## AztecCode

- Both the full range mode and the compact mode are supported.

---

## How to Print

Open print data file in an application, and specify 2D symbol font, point, and language that you have set on the printer driver, and then print it.



- The 2D symbol font size cannot be changed from the point set in [Specified Point]. If you specify a size other than the specified one, the 2D symbol is not printed.
- Some application such as .NET application may not be able to display or let you select the 2D symbol font registered by the printer driver. If that occurs, use the [Font Replacement] function of the printer driver to replace a True Type font with the 2D symbol font. See "[Printing Barcodes / 2D Symbols on .NET Environment](#)" on page 113.

## Printing Barcodes / 2D Symbols on .NET Environment

Since .NET Framework supports only True Type fonts and Open Type fonts, barcode or 2D symbol fonts registered in the printer driver cannot be printed. To solve the problem, use the [Font Replacement] function of the printer driver to replace a True Type font with the barcode or 2D symbol font. Then you can print the barcode or 2D symbol fonts from an application on .NET Framework environment.

On the application, font name of the replaced True Type font is displayed, however, when the data is printed, the barcode or 2D symbol is printed.

### Font Replacement

To set font replacement, open the printer driver, select [Driver Utilities] tab, and then select [Font Replacement].

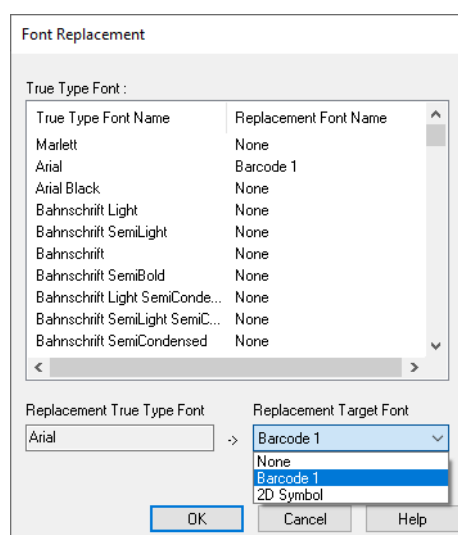

#### 1 Make the following settings.

- Replacement True Type Font
  - \* Select a True Type font you want to substitute.
- Replacement Target Font
  - \* Select a barcode or 2D symbol font you want to use.

#### 2 Click [OK].

The True Type font is replaced with the barcode or 2D symbol font.

---

## Printing Barcodes/2D Symbols

In the print data file, specify the True Type font that you replaced with the barcode or 2D symbol font, and specify the point and language.



- The point of barcode or 2D symbol is predetermined. Check the point in the [Barcode and 2D Symbol Settings] on the [Driver Utilities] window. If you specify a value other than the specified one, the barcode or 2D symbol is not printed.
- You cannot use the replaced True Type font for data other than barcode or 2D symbol data. If you use the font for other characters, the characters will not be printed. Therefore, make sure to select a True Type font that you do not use for printing data other than barcodes or 2D symbols.

## Favorite Settings

The Favorite Settings function allows you to register and manage print settings of the printer driver.



Note that this function is completely different from the [Favorite Setting] available from the control panel of the printer, and they are not compatible with each other.

The print settings include the settings available on the [General] and [Options] windows. Various settings such as paper type, paper layout, user-defined paper settings are included in the print settings.

[General] window

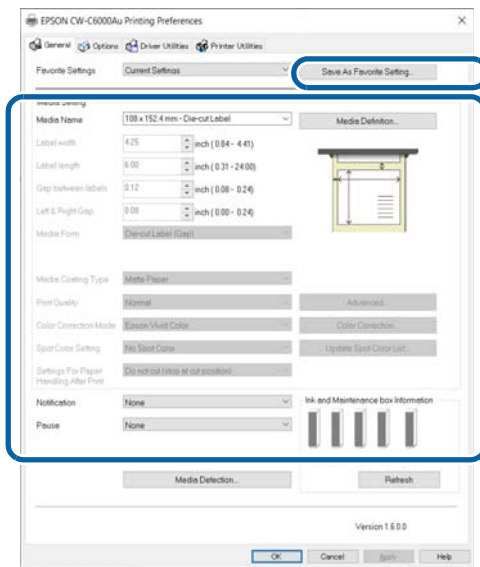

Favorite Settings

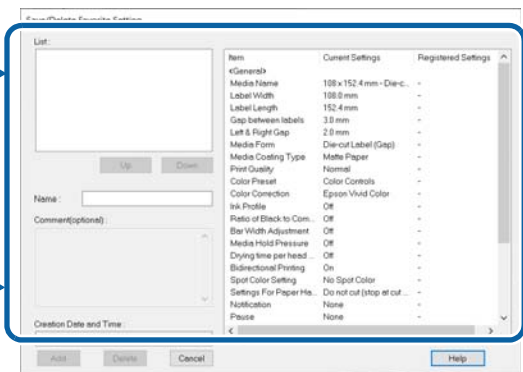

[Options] window

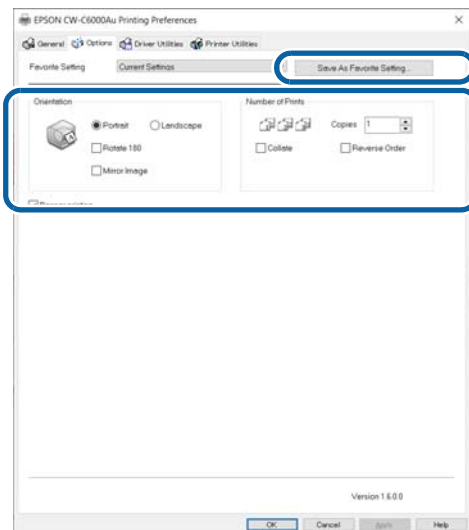

## Features

- Many sets of print settings can be registered in [Favorite Settings].  
If you frequently use multiple sets of print settings due to use of different sizes or types of paper or other reasons, register each set of the print settings to [Favorite Settings] so that you can complete print settings just by selecting the set from the [Favorite Settings] list. This also allows you to prevent misprint due to wrong print settings.  
(If you change paper type or size, you may need to change the [Media Detect] setting of the printer.)

## Registering Print Settings in [Favorite Settings]

- 1 Make the print settings to match them with the paper you use.**  
Configure the print settings on the [General] and [Options] windows. When using a user-defined paper, select it from the [Media Name] list on the [General] window.

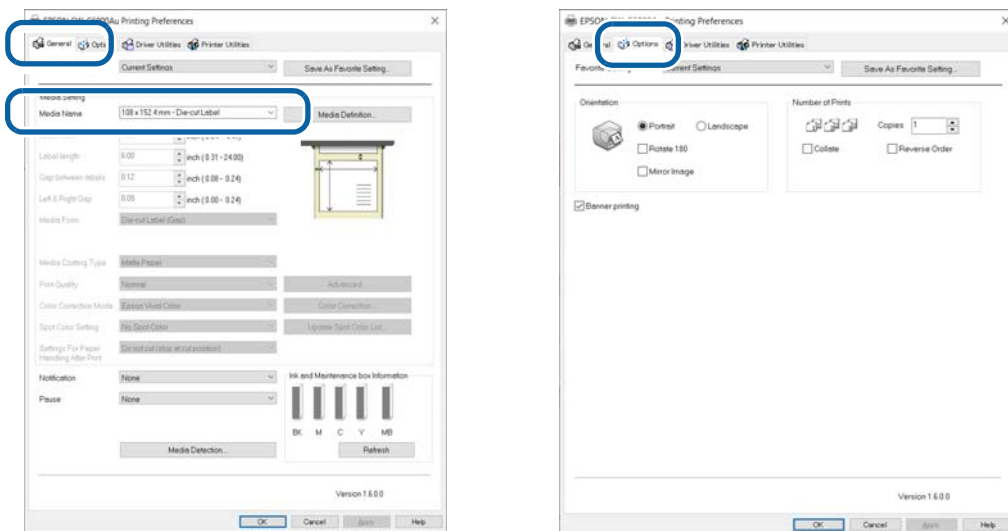

- 2 Click [Save as Favorite Setting]. The Save/Delete Favorite Setting screen appears.**  
The current settings are displayed on the right side of the screen.

- 3 Enter a name of the settings in the [Name] field, and then click [Add].**  
The Save/Delete Favorite Setting screen is closed.

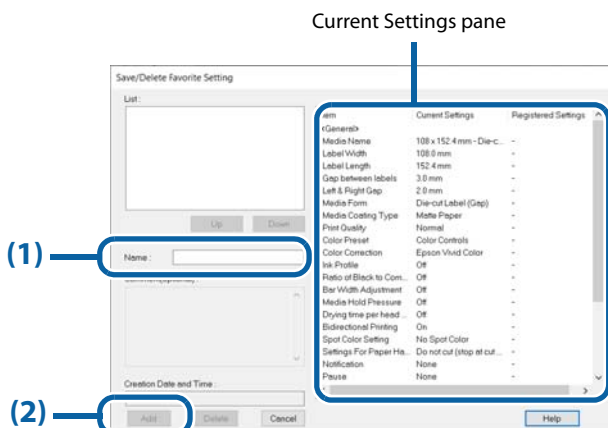

#### 4 Check that the name of the added print settings is displayed in the list of [Favorite Settings].

Registered in [Favorite Settings]

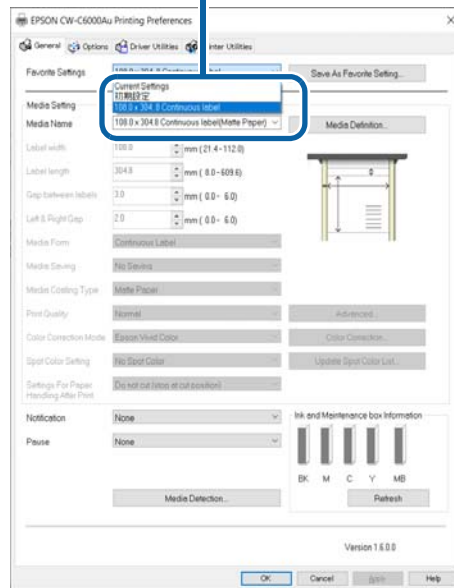

The [Favorite Settings] includes the following settings.

- **Default Settings:** The printer driver has these settings by default.
- **Current Settings:** The settings currently configured on the [General] and [Options] windows. You can check the settings on the [Show Settings] screen and on the [Save/Delete Favorite Setting] screen.
- **Registered Settings:** Print settings registered by the user.

## User Defined Information

The following information is included in User Defined Information.

- User-defined paper settings
- Registered barcode font settings
- Font replacement settings for .NET environment

The user defined information is set on each client computer.

If multiple printer drivers have been installed on one computer, the information can be shared between the multiple printer drivers.

## Exporting/Importing Printer Driver Settings

You can export Favorite Settings, user defined information, and Driver Preferences settings to a BSF file (the extension is .BSF). By importing the exported BSF file, the same settings can be applied to the printer driver on another computer.



- Note that the [Favorite Settings] function on the printer driver is completely different from the [Favorite Setting] function of the printer. It is impossible to include the [Favorite Setting] of the printer in the printer driver settings file.
- The BSF file contains the model number of the printer and the model number is checked when the file is imported to prevent mix up the file with the file for another printer model. In this way, the BSF file can be imported to only the printer driver for the printer with the same model number. You cannot exchange the BSF file between the auto cutter model and the peeler model, or between the 8-inch width model and the 4-inch width model.

## Exporting Settings File

Export the settings file following the steps below.

### 1 Check that the set of print settings you want to export has been registered in [Favorite Settings].



- If there are multiple entries registered in [Favorite Settings], all entries are exported to the BSF file. When the BSF file is imported, the registered entry at the top of the settings list will be reflected. Edit the order of the registered entries as necessary.

When importing, [Speed] is reflected.

When importing, [Normal] is reflected.

When importing, [Quality] is reflected.

- To change the order in the [Favorite Settings] list, open the Save/Delete Favorite Setting screen, select a set of print settings, and then click [Up] or [Down].

- If no set of print settings has been registered in [Favorite Settings], default print settings of the printer driver will be reflected.

## 2 Select the [Driver Utilities] tab. Click [Import/Export Settings].

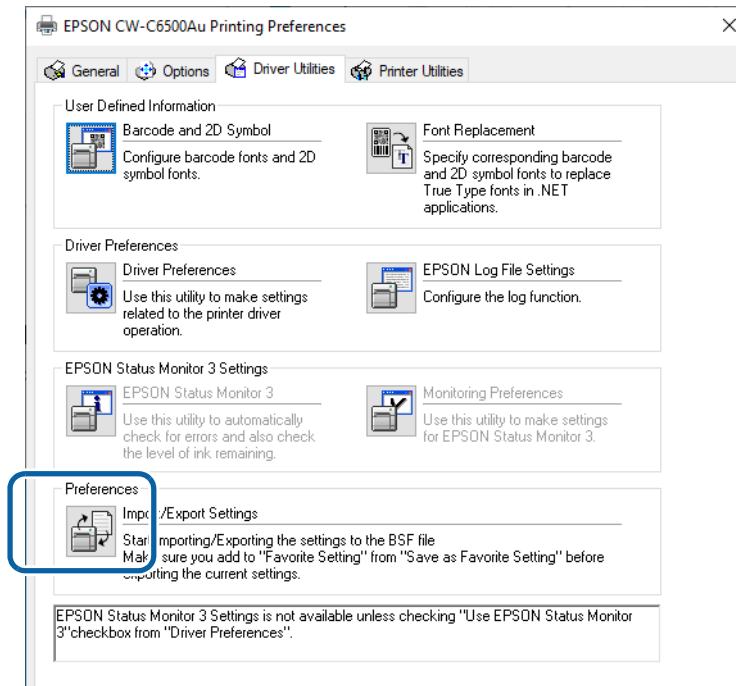

Export in a BSF file from the current settings. If you export it from the general setting, a different content will be exported.

- Current Settings:  
Properties of the printer driver - [General] - [Printing References] - [Driver Utilities] - [Import/Export Settings]
- General setting:  
Properties of the printer driver - [Advanced] - [Printing Defaults] - [Driver Utilities] - [Import/Export Settings]

## 3 The Import/Export Settings window appears. Click [Export Settings].

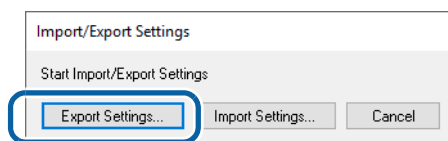

## 4 A window to save the settings file appears. Save the BSF file under a new file name.

## 5 The process completion screen appears. Click [OK].



To the BSF file, a set of print settings registered in [Favorite Settings] is exported. Print settings displayed in the [Current Settings] are not exported.

---

## Importing Settings File



When the BSF file is imported to the printer driver, the printer driver settings are overwritten with the imported settings. If you keep the following settings unchanged, create BSF files to include them.

- List of Favorite Settings
- List of user-defined paper settings
- List of barcode fonts
- List of font replacement for barcode

Import the settings file following the steps below.

- 1** Select the [Driver Utilities] tab. Click [Import/Export Settings].
- 2** The Import/Export Settings window appears. Click [Import Settings].
- 3** A confirmation window appears. Click [OK].
- 4** The window to open a file appears. Select the file to be imported.
- 5** The process completion screen appears. Click [OK].

## 6 Check that the set of print settings you want to export has been registered in [Favorite Settings].



- If there are multiple entries registered in [Favorite Settings], the registered entry at the top of the settings list will be reflected. If the registered entry you wanted is not reflected, modify the order of the settings list and export the BSF file again.

Save/Delete Favorite Setting

List:

- Default Settings
- Speed
- Normal
- Quality

Up Down

Name:

Comment(optional):

Creation Date and Time:

Add Delete Cancel

When importing, [Speed] is reflected.

Save/Delete Favorite Setting

List:

- Default Settings
- Normal
- Speed
- Quality

Up Down

Name:

Comment(optional):

Creation Date and Time:

Add Delete Cancel

When importing, [Normal] is reflected.

Save/Delete Favorite Setting

List:

- Default Settings
- Quality
- Normal
- Speed

Up Down

Name:

Comment(optional):

Creation Date and Time:

Add Delete Cancel

When importing, [Quality] is reflected.

- To change the order in the [Favorite Settings] list, open the Save/Delete Favorite Setting screen, select a set of print settings, and then click [Up] or [Down].

Save/Delete Favorite Setting

List:

- Default Settings
- Speed
- Normal
- Quality

Up Down

Name:

Comment(optional):

Creation Date and Time:

Save Delete Cancel

Save/Delete Favorite Setting

List:

- Default Settings
- Speed
- Quality
- Normal

Up Down

Name:

Comment(optional):

Creation Date and Time:

Save Delete Cancel

Save/Delete Favorite Setting

List:

- Default Settings
- Quality
- Speed
- Normal

Up Down

Name:

Comment(optional):

Creation Date and Time:

Save Delete Cancel

- If no set of print settings has been registered in [Favorite Settings], default print settings of the printer driver will be reflected.
- BSF files are not compatible in the following cases.
  - Between different versions of the driver
  - Between different builds/versions of Windows
  - Between different architectures of Windows (32-bit/64-bit)

## Starting PrinterSetting from the Printer Driver

Start PrinterSetting from the printer driver following the steps below.

- 1 Open the printer driver window.
- 2 Select the [Printer Utilities] tab. Click [Printer Settings].

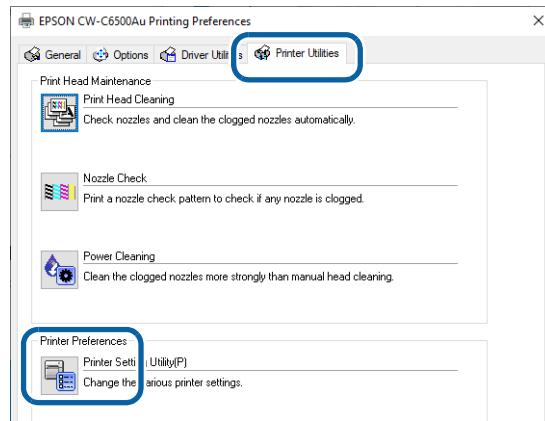

- 3 The CW-C6XXX PrinterSetting screen appears.

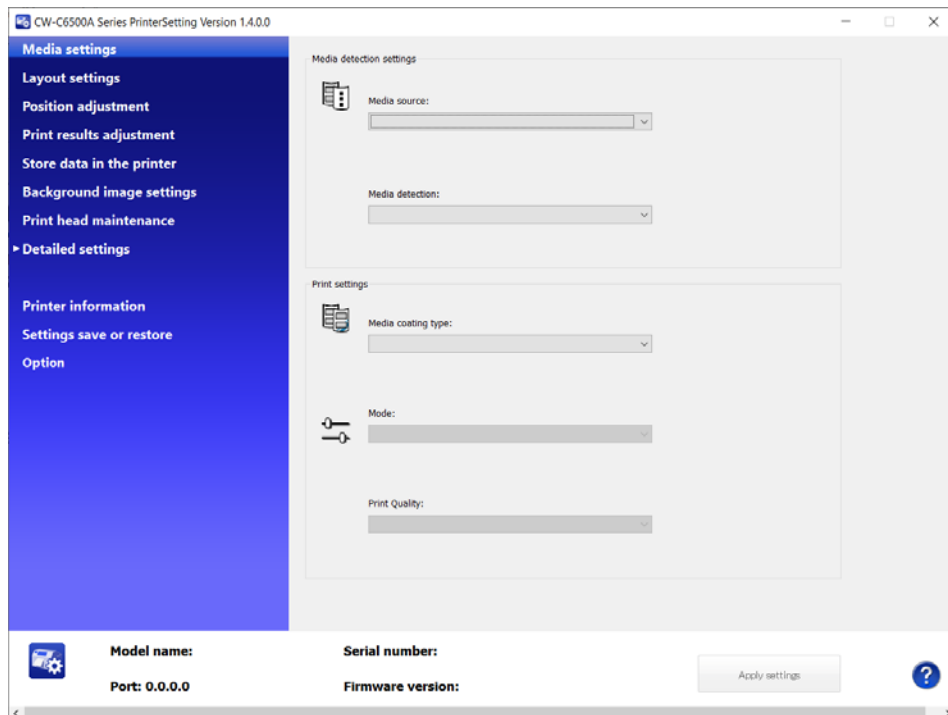

## Speeding Up Printing using High Speed Batch Label Printing Function

The [High speed batch label printing] function allows you to print a large number of labels faster. Before using the function, read and understand "[Restrictions](#)" on page 125.

The function is available with versions 1.4.0.0 or later of the printer driver. To get the latest version of the printer driver see "[How to Get Software](#)" on page 415.

---

### Overview of the Function

When printing labels without using the [High speed batch label printing] function (normal printing), label data is sent one by one to the printer even when printing multiple copies of the same label. Each time one label is printed, the printer needs to conduct operations required between labels such as leaving a space.

When the [High speed batch label printing] function is enabled, the printer driver merges multiple labels so that the total length fits inside 600 mm (23.62 inches) and sends it to the printer as one piece of data. This reduces time required for operations between labels, so the total time required for printing labels is reduced.

#### **Example: When printing 100 copies of 97 mm (3.81 inches) length label with 3 mm (0.19 inches) margin between labels**

(1) Normal printing: (Print 1 label + Operation required between labels) x 100 times

(2) High speed batch label printing: (Print 6 labels at a time + Operation required between labels) x 17 times

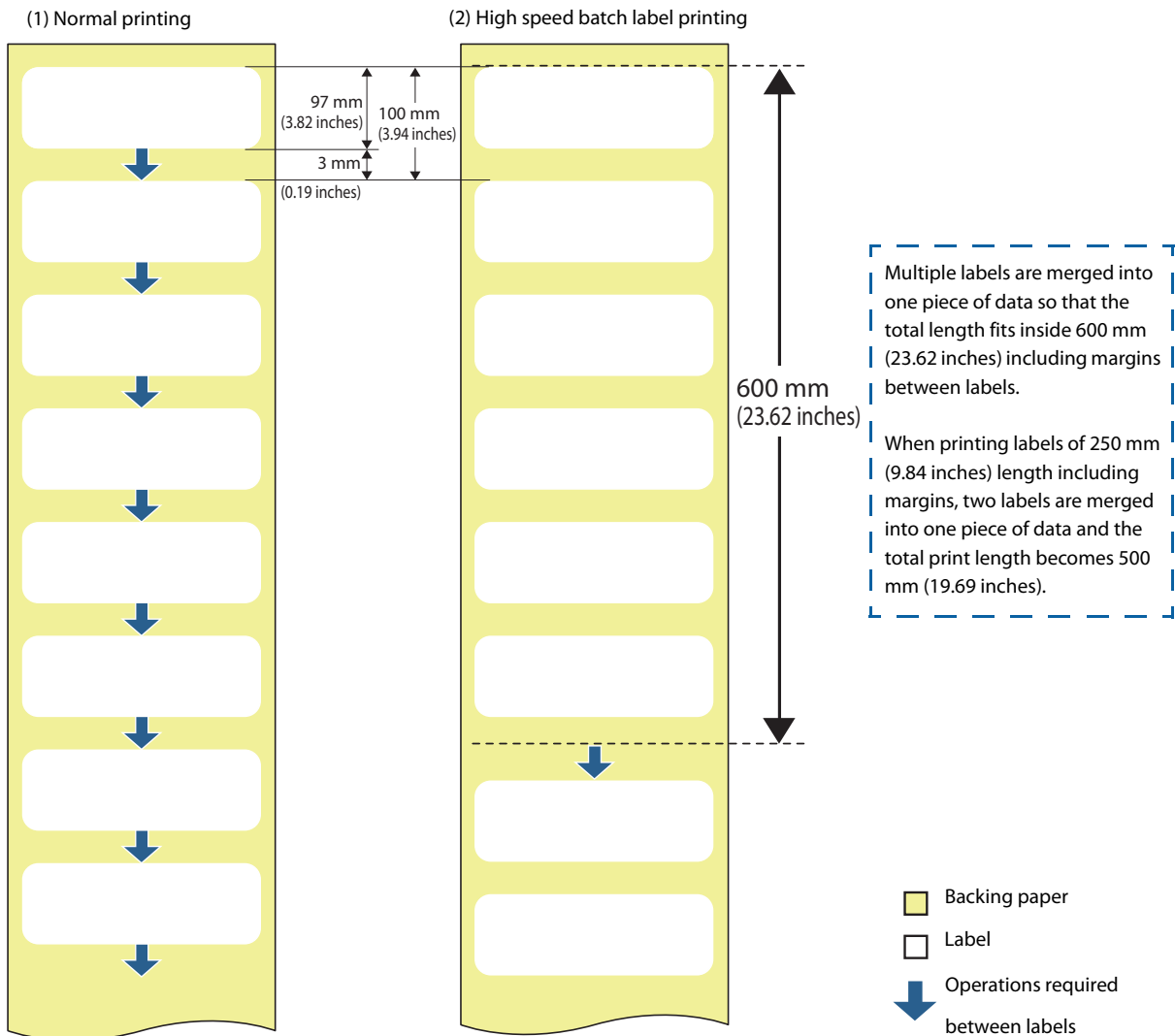

## Restrictions

The following describes restrictions on using [High speed batch label printing].

- Accuracy of print position in the paper feed direction may be lowered.
- You cannot use functions that are designed to operate for each single label on an application.
- [Settings For Paper Handling After Print] for the Peeler model do not work normally except for the [Rewind] option.
- Both [Cut] and [Do not cut] options in [Settings For Paper Handling After Print] for the Auto Cutter model do not work normally.
- The [Notification] and [Pause] settings do not work normally.
- Compared to normal printing, it takes longer to start printing since this batch print function merges multiple labels into one data.
- If a paper jam occurs, you may lose multiple labels at a time. In addition, multiple labels will be printed when the printer recovers from the error.
- Multiple labels merged into up to 600 mm (23.62 inches) length data are counted as one copy.

- You cannot stop the printer at a position between labels by pressing the Pause button on the printer.
- The number of pages displayed on the panel (e.g., "Printing page 1/1") indicates the number of data pieces compiled, not the actual number of pages printed.

## How to Set

Follow the procedure below to enable [High speed batch label printing].

- 1 Open the printer driver window.
- 2 Click the [Driver Utilities] tab.

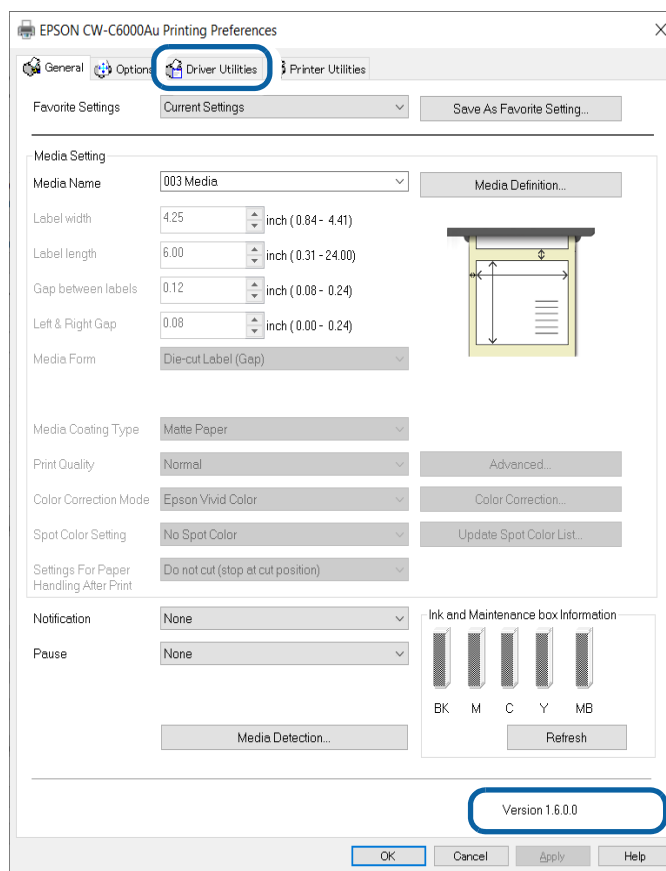

### 3 Click [Driver Preferences].

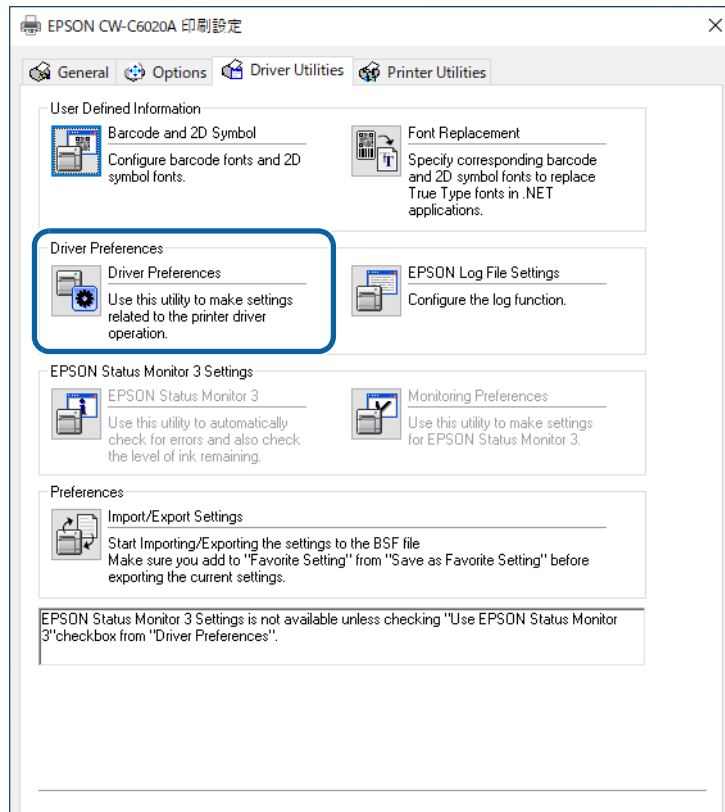

### 4 Select the checkbox for [High speed batch label printing], and then click [OK].

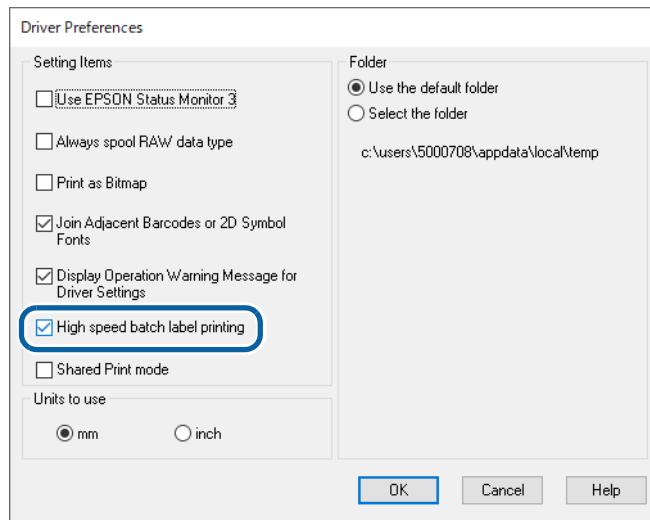

From the next time you print labels, multiple labels are automatically merged into up to 600 mm (23.62 inches) length data and then printed.

## If the Print Position is Shifted

Perform the following procedure and see if you can reduce the print position shifting.

### Executing Media Feed Adjustment

Execute media feed adjustment using PrinterSetting (Windows). ["Start adjustment" on page 194](#)

This can be selected from the operation panel using the following procedure.

[Media Settings] - [Print Position Adjustment]

If the problem is not resolved, carry out the following procedure.

### Checking the Label Position on the Media Used

Check if the virtual label position in the compiled data matches the label position on the media actually used and then revise the driver settings. ["Modifying the Media Size Setting" on page 129](#)

If the problem is not resolved, carry out the following procedure.

### Checking How the Print Start Position Is Shifted

Check if there is regularity in the direction to which the print start position shifts. ["Checking How the Print Start Position is Shifted" on page 132](#)

If there is no regularity, the label position may be unevenly distributed. In this case, the high speed batch label printing function cannot be used. Investigate improving the accuracy of the media you are using.

If there is regularity, carry out the following procedure.

### Checking the Gap Between Labels

Check the position of the label printed at the end of the compiled data and then revise the driver settings. ["Checking the Gap Between Pages" on page 133](#)

## Executing Media Feed Adjustment

If there is a problem with the media feeding, the print start position may be shifted.

Execute media feed adjustment using PrinterSetting (Windows). ["Start adjustment" on page 194](#)

This can be selected from the operation panel using the following procedure.

[Media Settings] - [Print Position Adjustment]

If the shift of the print position does not improve after performing the media feed adjustment, perform the following procedure. ["Modifying the Media Size Setting" on page 129](#)

## Modifying the Media Size Setting

The label length (l) and gap between labels (g) set in the driver will be used repeatedly when compiling the data. Therefore, measuring multiple label positions that are actually used and setting the average value in the driver may improve the print position.

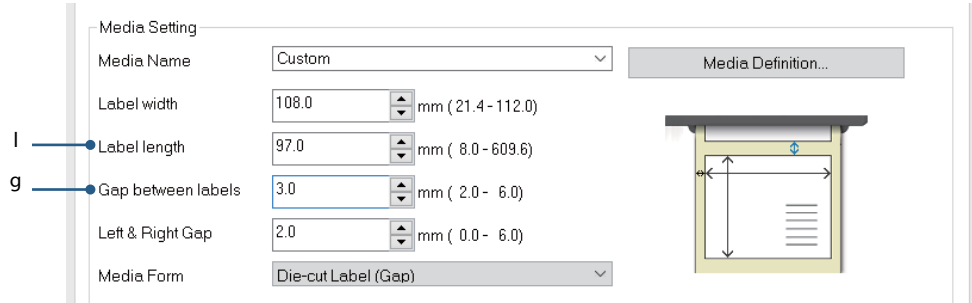

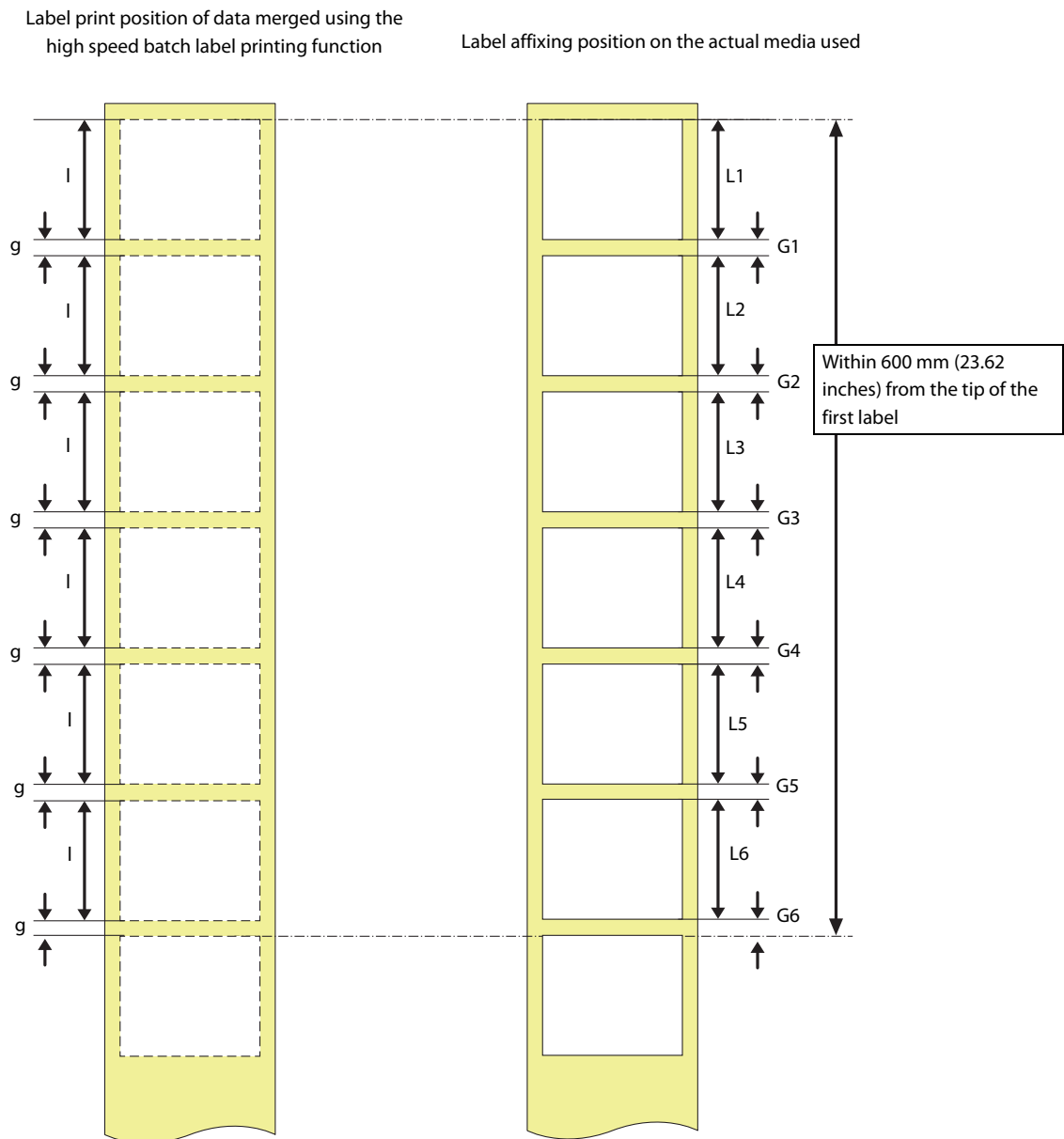

Check it following the procedure below.

- 1** Measure the label length of the actual media used [e.g.: L1, L2, L3, L4, L5, L6] and gap between pages [e.g.: G1, G2, G3, G4, G5, G6]. This applies to cases where the distance from the tip of the first label is up to 600 mm (23.62 inches).
- 2** Calculate the average measured label length [e.g.:  $L = (L1 + L2 + L3 + L4 + L5 + L6) / 6$ ] and the average gap between pages [e.g.:  $G = (G1 + G2 + G3 + G4 + G5 + G6) / 6$ ].
- 3** Check if the calculated average label length L of the actual media and the label length I of the printer driver match.  
If they do not match, enter the length L for the label length in the driver.

#### **4 Check if the calculated average gap between pages G of the actual media and the gap between pages g of the printer driver match.**

If they do not match, enter the gap G for the gap between pages in the driver.

If the shift of the print start position does not improve after performing the above procedure, perform the following procedure. ["Checking How the Print Start Position is Shifted" on page 132](#)

### Checking How the Print Start Position is Shifted

If there is a regularity in the shift of the print start position, such as when the shift increases by 1 mm (0.04 inches) per label, perform the following procedure. "Checking the Gap Between Pages" on page 133

If there is no regularity, the label position may be unevenly distributed. In this case, the high speed batch label printing function cannot be used. Investigate improving the accuracy of the media you are using.

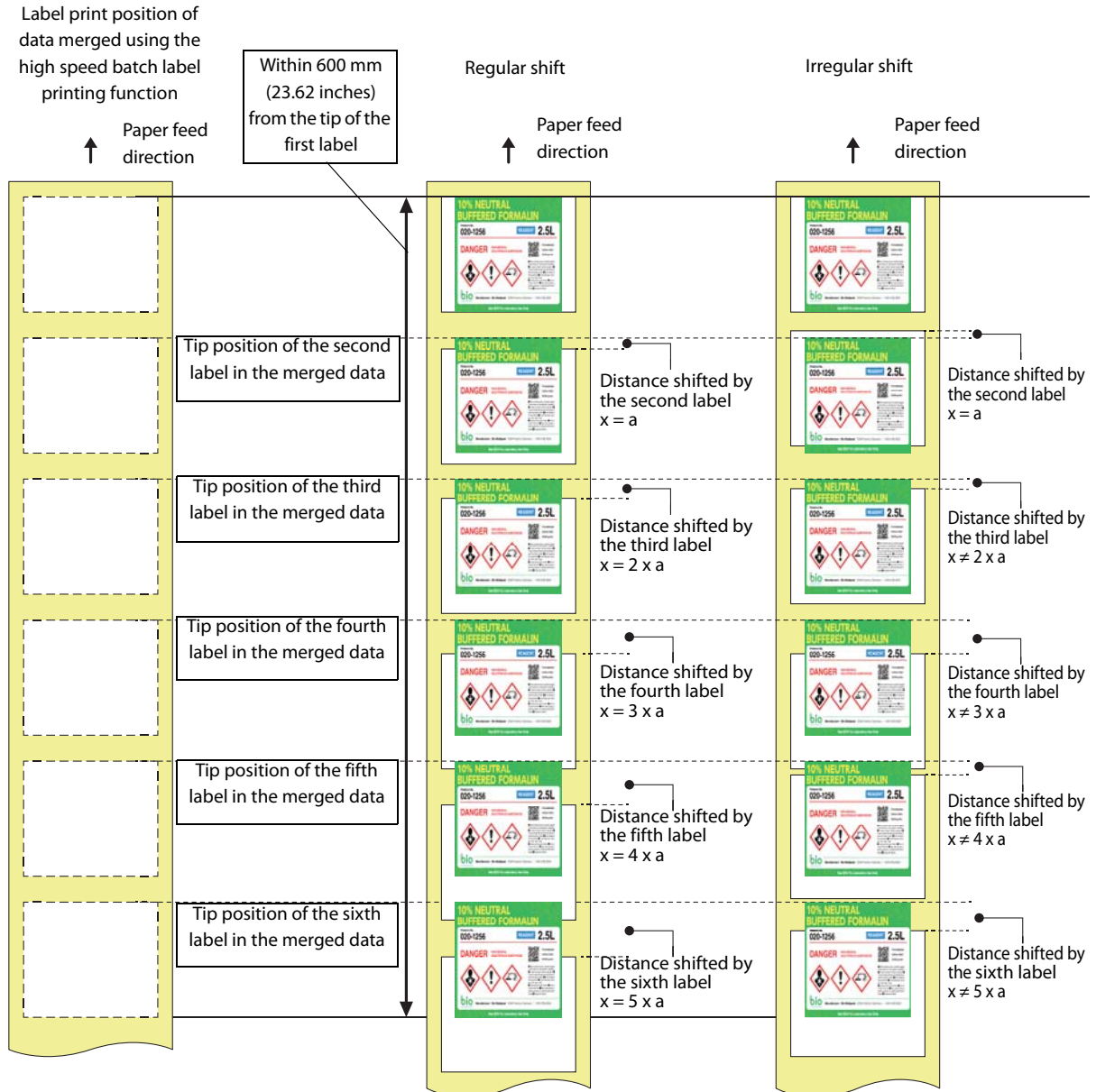

a: Distance shifted between the tip of the second label in the merged data and the tip position of the second label on the media actually used

x: Distance shifted between the tip of the nth label in the merged data and the tip position of the nth label on the media actually used

### Checking the Gap Between Pages

Measure the shifted distance between the tip of the last label printed from the merged data and the actual print start position.

Calculate how many millimeters each label is shifted. You can check this by using: the distance the labels have shifted / (the number of labels connected - 1).

For example, if six labels are connected in one piece of data, and the sixth label is shifted by 1.0 mm (0.04 inches), you can adjust the gap between pages by 0.2 mm (0.01 inches) to eliminate the shift in all six labels.

$1.0 \text{ mm (0.04 inches)} / (6 \text{ labels} - 1) = 0.2 \text{ mm (0.01 inches)}$

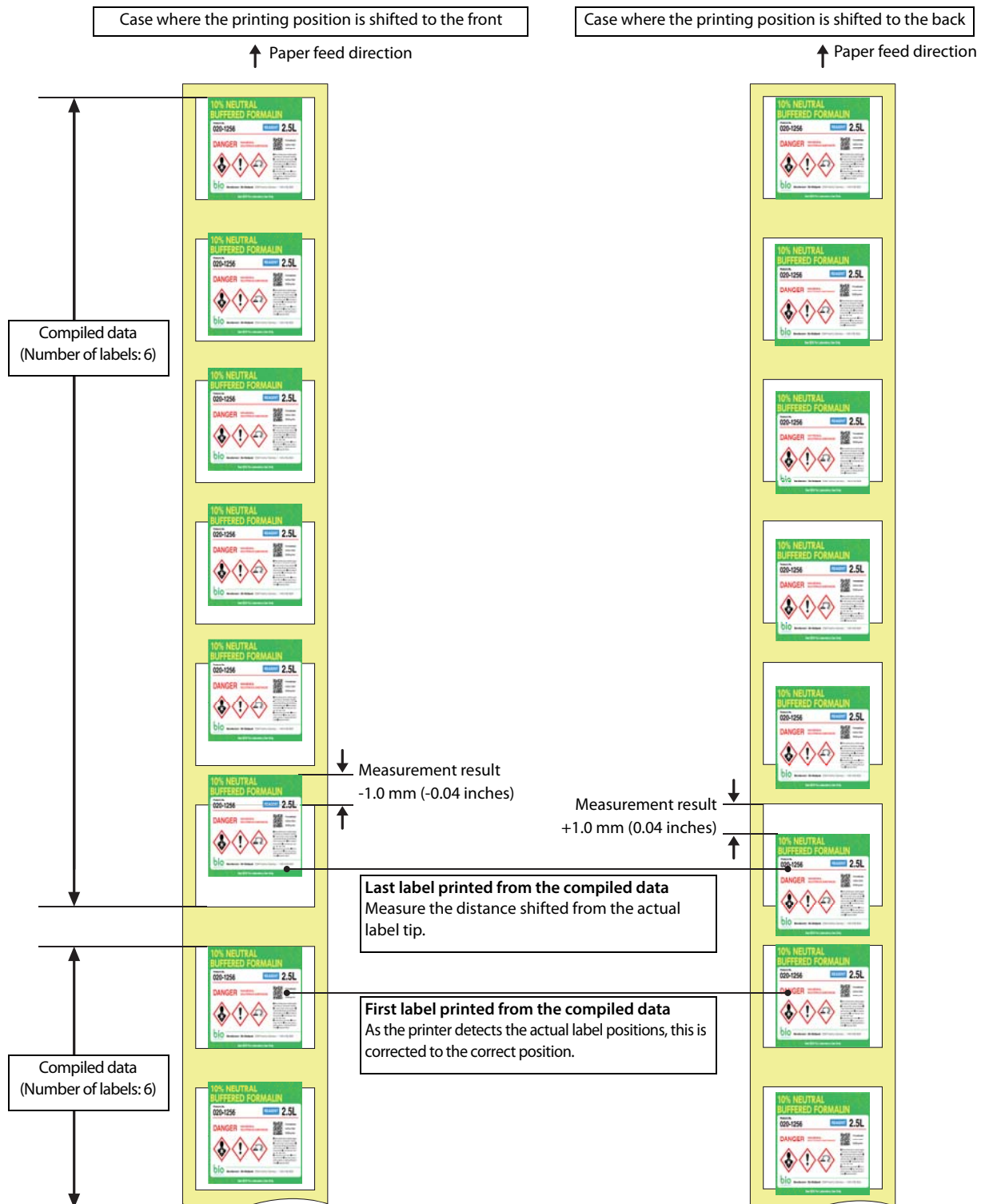

## Sharing the Printer Driver

The printer driver installed on a server can be shared and used by multiple client computers. Since the clients can use the printer driver settings made on the server, various printing settings can be shared easily. This saves you the trouble of installing and setting the printer driver on each client computer.

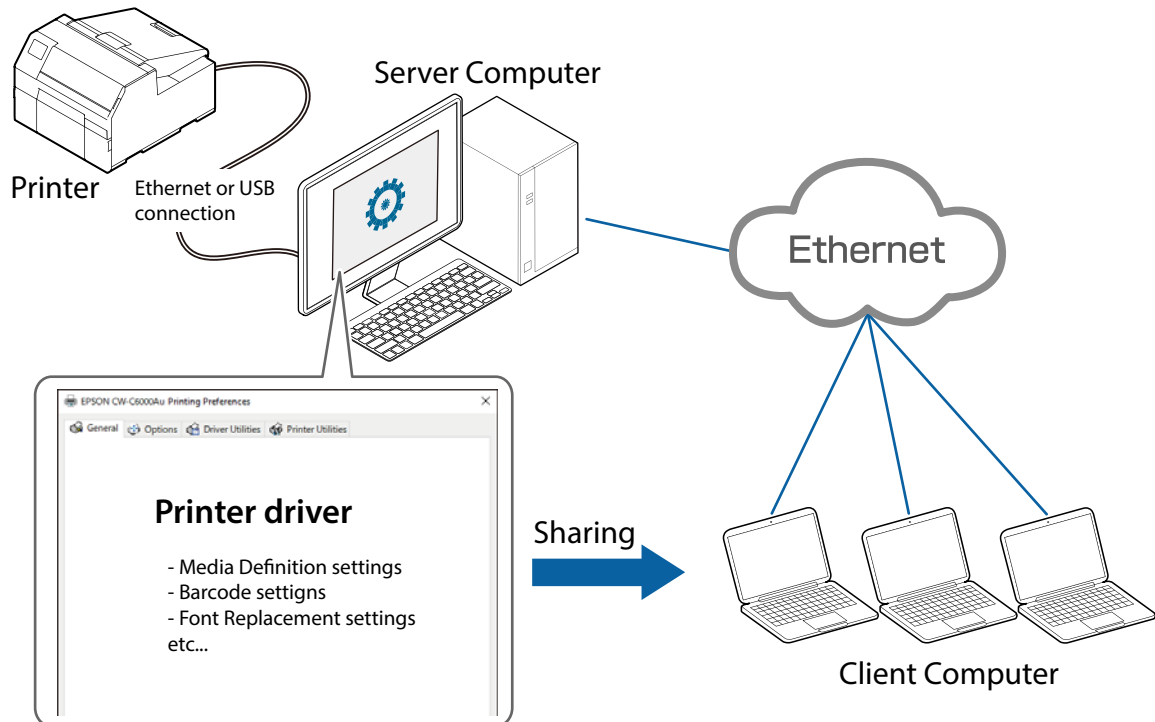

### IMPORTANT

- The printer driver of version 1.4.0.0 or later is required for sharing. If the version of your printer driver is older than that, sharing is not possible. To get the latest version of the printer driver see ["Downloading Printer Driver, Utilities, and Manuals" on page 415](#).

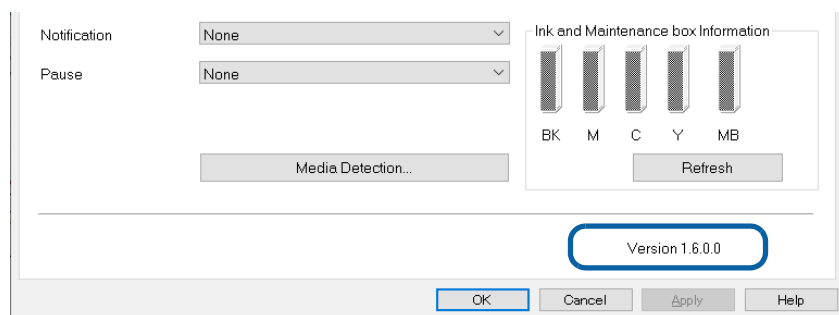

- Depending on configuration of your system, starting PrinterSetting ( [Page 187](#) ) from the printer driver is disabled. ["Restrictions on using PrinterSetting" on page 157](#)



Ethernet connection allows you to control multiple printers if they are connected to the same network as the server computer.

Follow the steps below to enable sharing of the printer driver. For details of each step, see the linked page.

### Procedure on a Server Computer

#### 1. Install the printer driver ( [Page 47](#) )

The installation procedure is the same as the normal installation procedure.

#### 2. Set up sharing settings on Windows [Devices and Printers] ( [Page 136](#) )

#### 3. Enable Shared Print mode on the printer driver ( [Page 138](#) )

#### 4. Add new settings such as user-defined paper (Media Definition) on the printer driver

See "User-Defined Paper" on page 87, "Printing Barcodes" on page 94, or other pages as necessary.

#### 5. Change the default settings of the printer driver ( [Page 141](#) )

Change the default printer driver settings to frequently used settings.



### Procedure on a Client Computer

#### 1. Connect to the server computer ( [Page 143](#) )

#### 2. Check the settings of the shared printer driver ( [Page 150](#) )

Check that the settings made at step 3 to 5 of "Procedure on a Server Computer" are correctly applied.



### IMPORTANT

- When you add new settings to the printer driver such as user-defined paper (Media Definition) or barcode font, make sure to add them after enabling [Shared Print mode]. The settings you added before enabling [Shared Print mode] become disabled because save location of the settings files is changed when the mode is enabled.
- The settings for shared information can only be added or changed using administrator privileges. As an account with user privileges cannot write from either a server PC or client PC, adding, editing, and deleting operations for the following functions are disabled.
  - Media Definition settings
  - Barcode and 2D Symbol Settings
  - Font Replacement
  - Favorite Settings
- If the server PC and client PC are not connected, the shared information settings cannot be changed. However, media settings for the shared information will not be synchronized even once the server PC is reconnected. Cancel the connection and restore the media settings on the client PC as necessary.

## Procedure on a Server Computer

### Setting up Sharing Settings on Windows [Devices and Printers]

- 1 Open [Devices and Printers].
- 2 Right-click the icon of the printer to be shared and then click [Printer properties].  
The Printer properties window appears.



- 3 Click the [Sharing] tab, and then select the check box for [Share this printer].

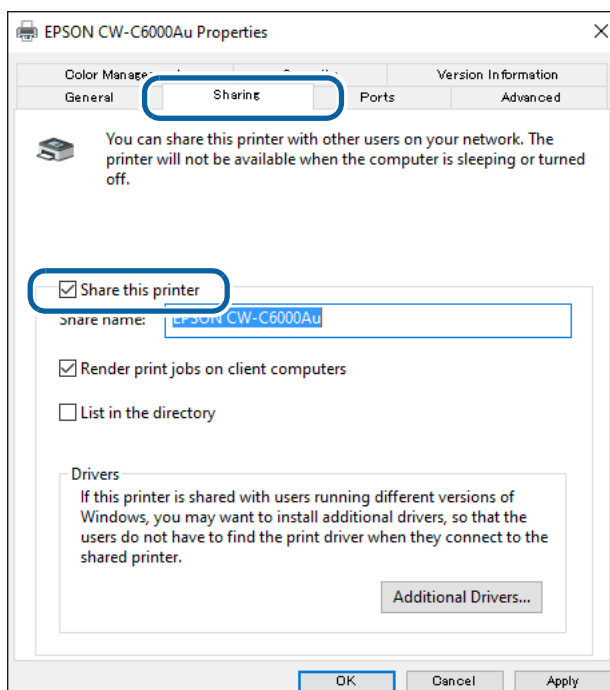

## 4 Select the check box for [Render print jobs on client computers].

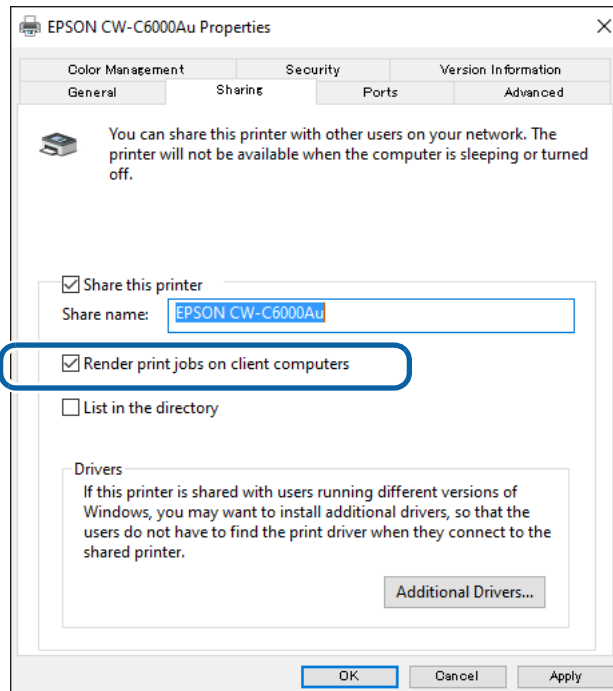

## 5 Click [OK].

## Enabling Shared Print Mode on the Printer Driver

- 1 Open [Devices and Printers].
- 2 Right-click the icon of the printer to be shared and then click [Printer properties].  
The Printer properties window appears.



- 3 Click the [Advanced] tab, and then click [Printing Defaults...].

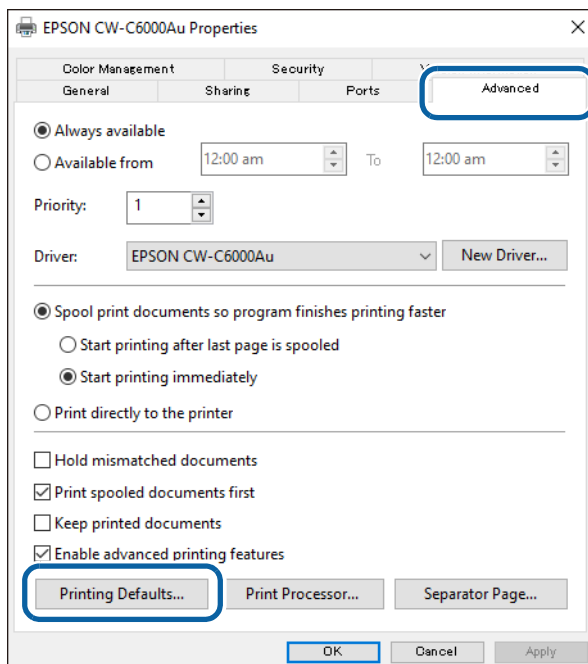

- 4** When print settings window appears, select the [Driver Utilities] tab, and then click [Driver Preferences].

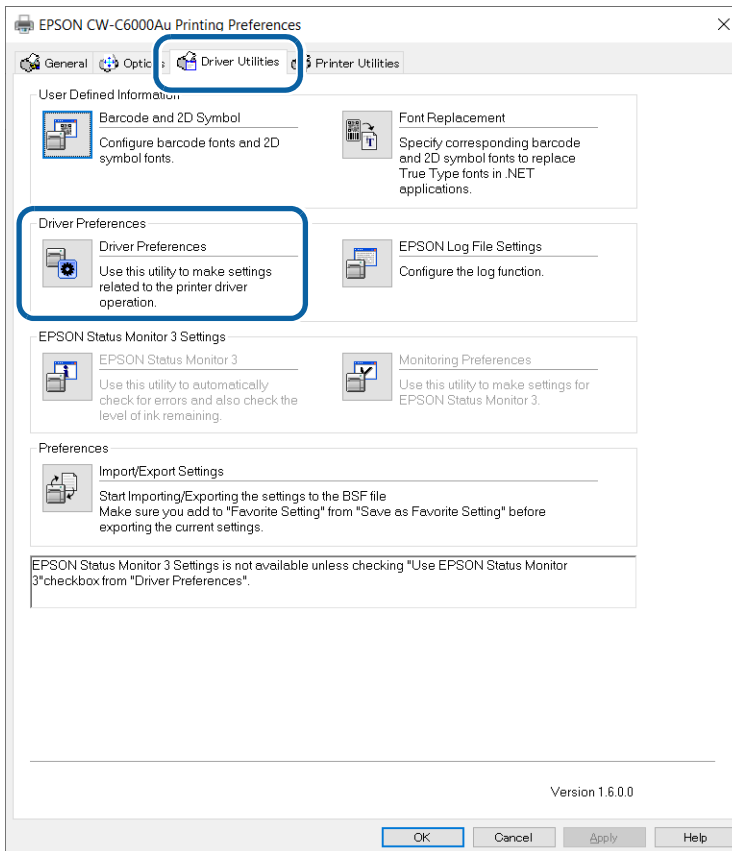

- 5** On the “Driver Preferences” window, select the check box for [Use EPSON Status Monitor 3] and [Shared Print mode].

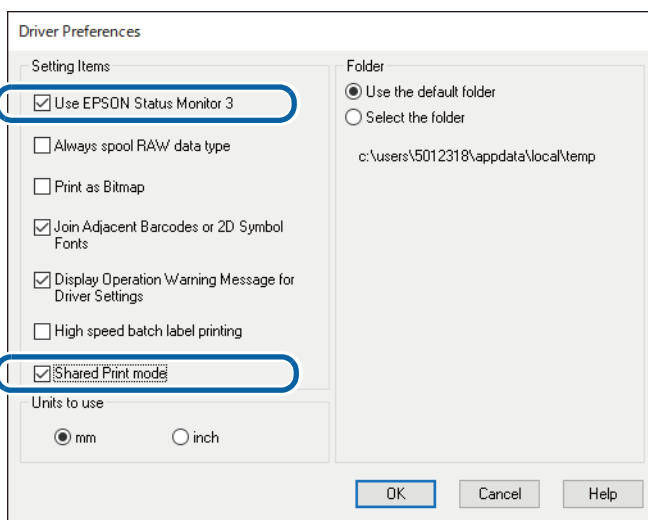

- 6** Click [OK] to return to the previous print settings window.

- 7** Click [Monitoring Preferences] on the “Driver Utilities” tab. The “Monitoring Preferences” window appears.

- 8 Select the check box for [Allow monitoring of shared printers], and then click [OK].

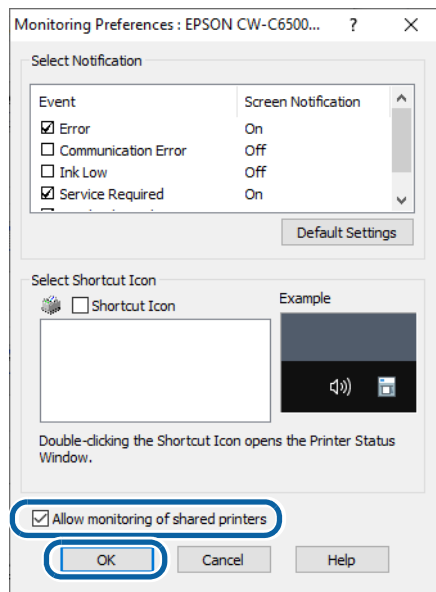

- 9 When the print settings window reappears, click [OK].
- The [Shared Print mode] setting is enabled from the next time you open the print settings window of the printer driver.

## Changing the Default Settings of the Printer Driver

You can change the default settings of the printer driver to frequently used settings such as selecting paper you added at [Media Definition]. This saves you the trouble of changing the settings each time you print.

If necessary, first add [Media Definition] settings ("[User-Defined Paper](#)" on page 87), barcode font ("[Printing Barcodes](#)" on page 94), or other settings, and then follow the procedure below to change the default settings.

### IMPORTANT

- When you add new settings to the printer driver such as user-defined paper (Media Definition) or barcode font, make sure to add them after enabling [Shared Print mode]. The settings you added before enabling [Shared Print mode] become disabled because save location of the settings files is changed when the mode is enabled.
- If you log in to the server or client computer with user privileges after setting up sharing settings, adding, editing, or deleting operations for the following functions are disabled because shared information is write-protected. Log in to the computer with administrator privileges.
  - Media Definition settings
  - Barcode and 2D Symbol Settings
  - Font Replacement
  - Favorite Settings

**1** Open [Devices and Printers].

**2** Right-click the icon of the printer to be shared and then click [Printer properties].  
The Printer properties window appears.



### 3 Click the [Advanced] tab, and then click [Printing Defaults...].

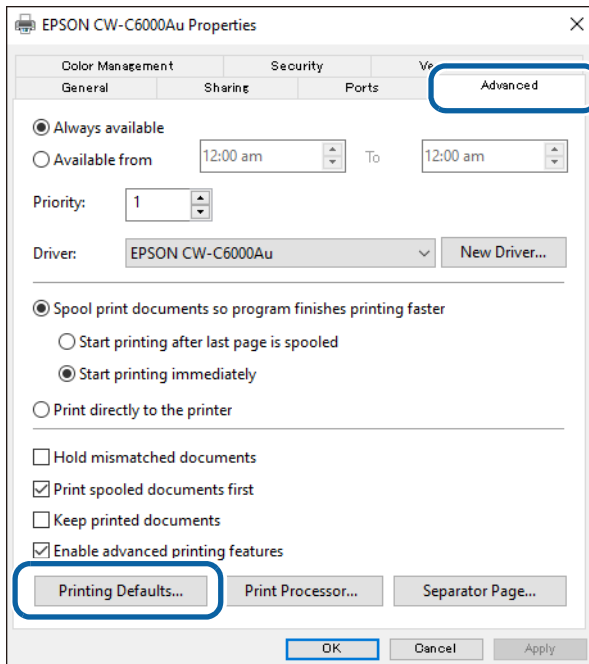

### 4 When the print settings window appears, change paper and other settings to frequently used settings.

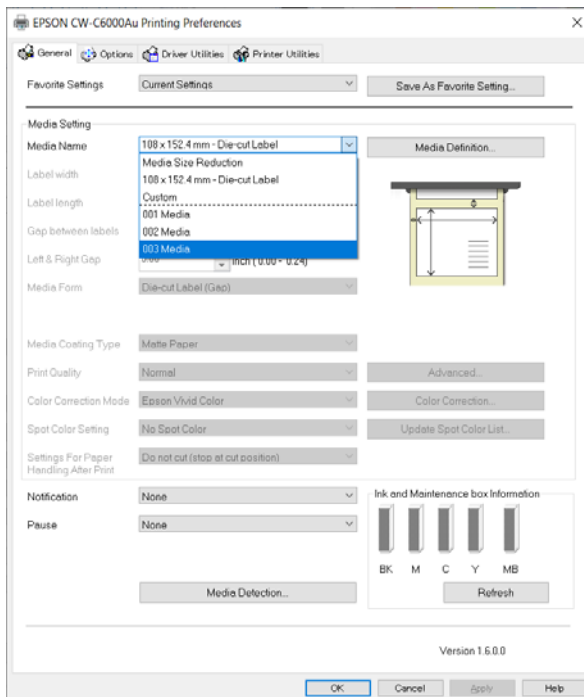

### 5 When finished, click [OK] to save the changes.

From the next time you open the printer driver, the print setting you made here will be reflected.

## Procedure on a Client Computer

### Connecting to the Server Computer

- 1 Open [Devices and Printers] and then click [Add a printer] on the menu bar. Searching for a printer is started.

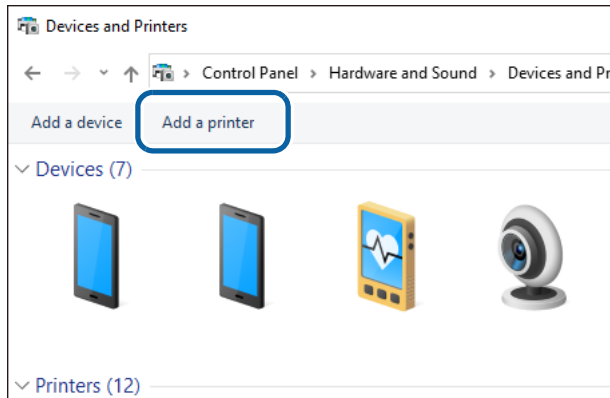

- 2 When the target printer is displayed, click on it. If the printer is not displayed, go to ["Connecting to the Server Computer \(When the Printer is Not Found\)"](#) on page 146.

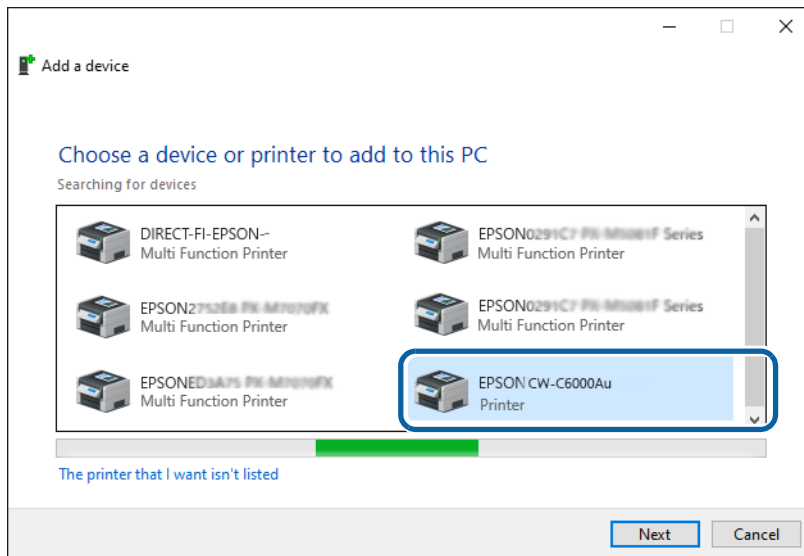

- 3 Wait until installation of the printer driver is finished.

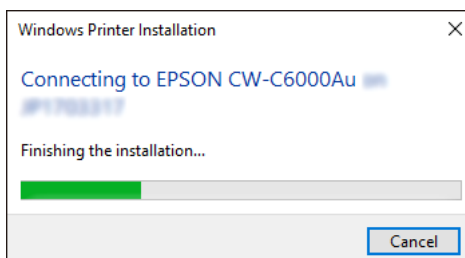

- 4** When the installation finishes successfully, the window below is displayed. Click [Next].

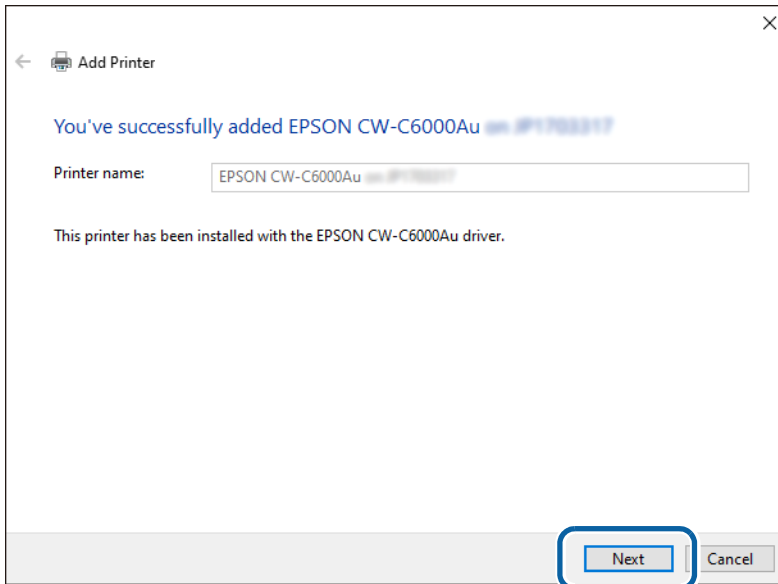

- 5** The window shown below is displayed. Click [Print a test page] to test whether printing from the printer is possible, or click [Finish] to finish.

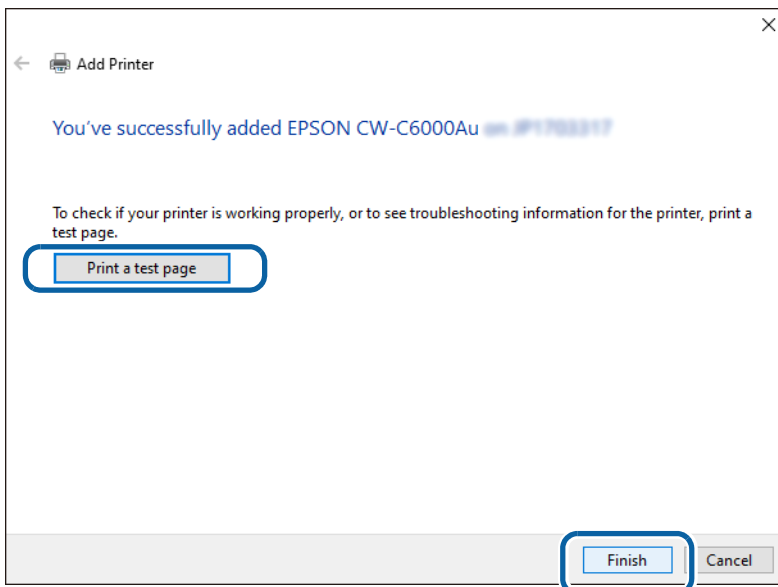

## 6 Open [Devices and Printers] again to check that the printer has been added in the window.



## Connecting to the Server Computer (When the Printer is Not Found)

If the printer is not displayed after clicking the [Add a printer] menu in [Devices and Printers], follow the procedure below.

- 1 Click [The printer that I want isn't listed] at the bottom of the printer search window.

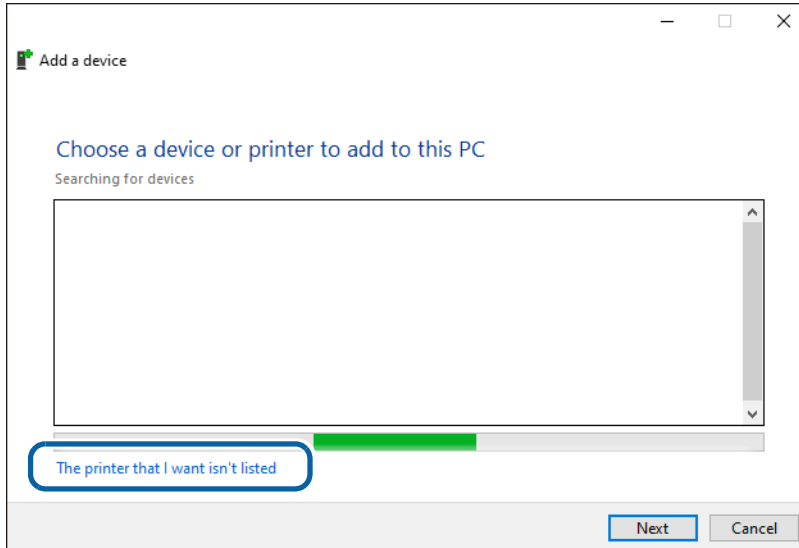

- 2 When the window shown below appears, select [Select a shared printer by name] and then click [Browse].

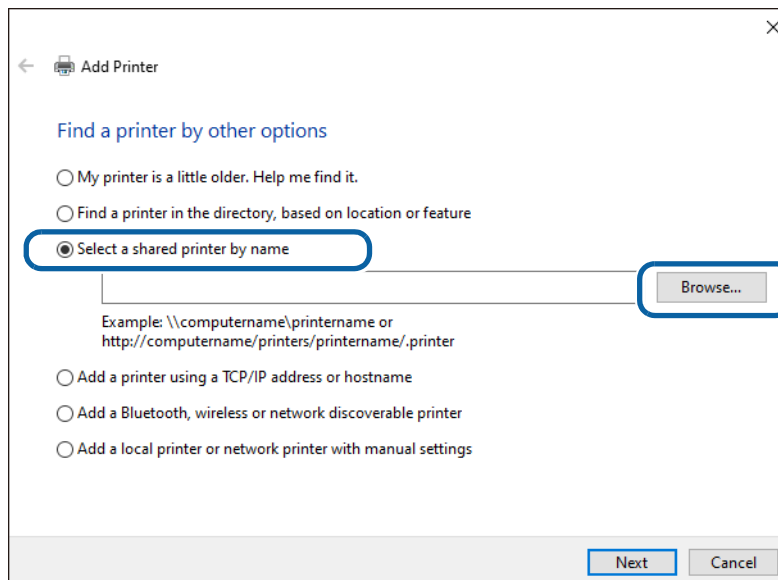

- 3** When the server computer is displayed under [Network], click on it. All devices shared on the server computer are listed.

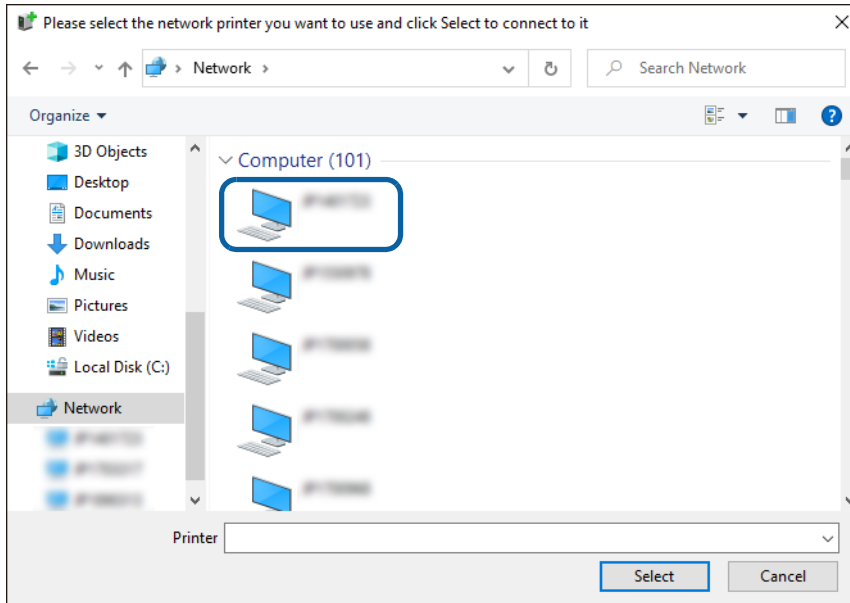

If network discovery has been disabled on the computer, change the setting to enable network discovery.

- 4** Click on the target printer. Check that the printer name is correct, and then click [Select].

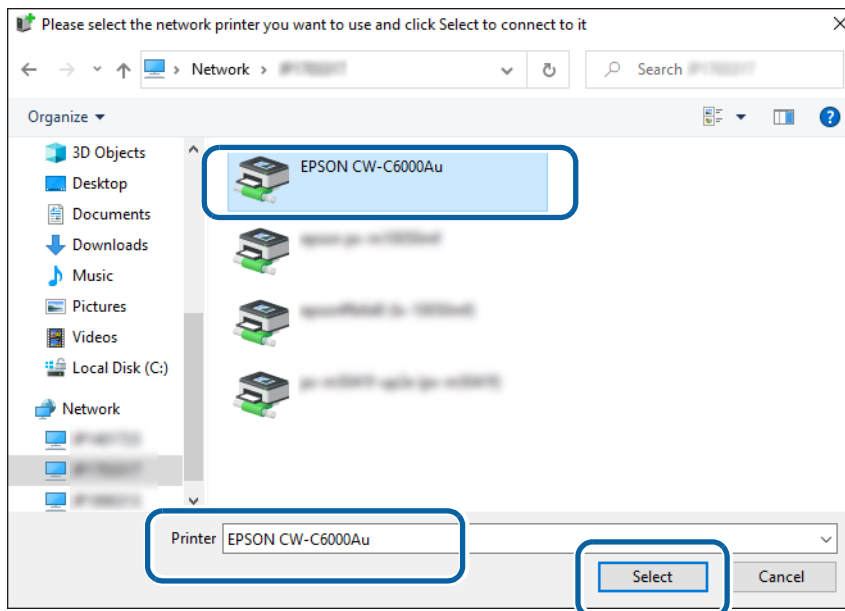

- 5** When the window shown below is displayed, click [Next].  
Wait until installation of the printer driver is finished.

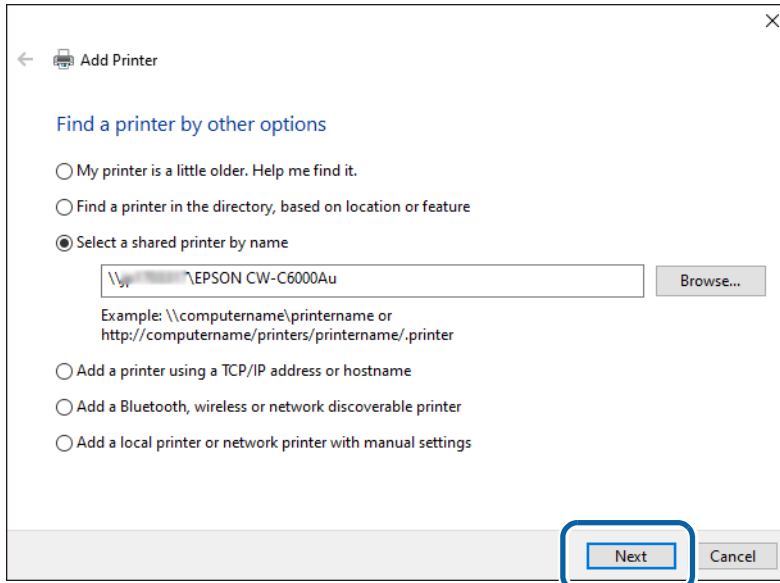

- 6** When the installation finishes successfully, the window below is displayed. Click [Next].

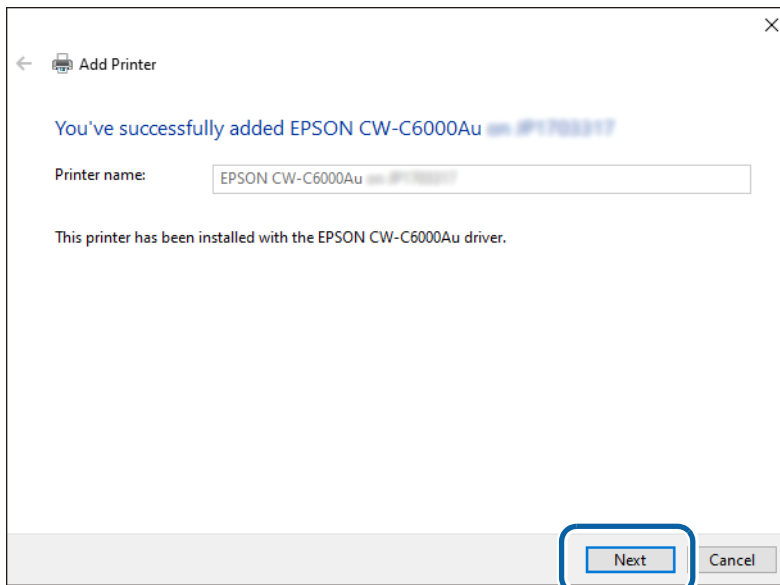

- 7** The window shown below is displayed. Click [Print a test page] to test whether printing from the printer is possible, or click [Finish] to finish.

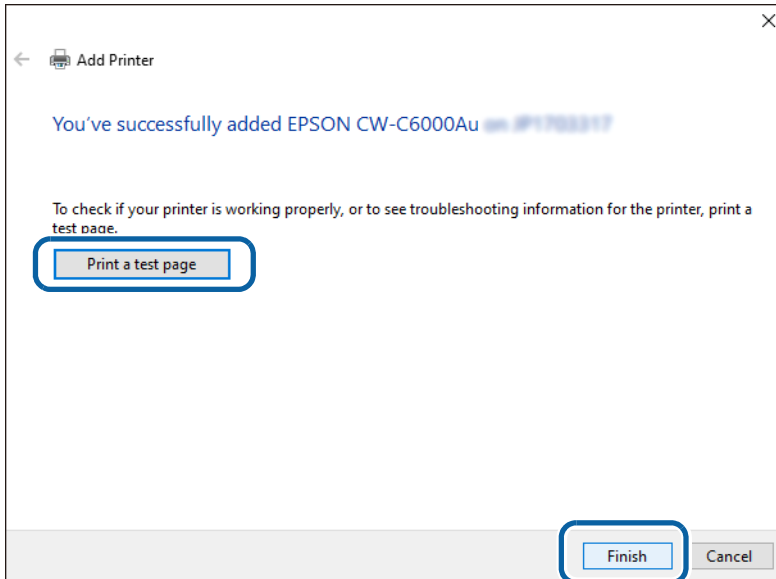

- 8** Open [Devices and Printers] again to check that the printer has been added in the window.



## Checking the Settings of the Shared Printer Driver

There are the following two methods for checking the printer driver settings.

- Open the printer driver window from application software you use and check the settings ( [Page 150](#) )
- Open the printer driver window from [Devices and Printers] and check the settings ( [Page 153](#) )

### ❑ Checking the Settings from Application Software, taking Paint for example

#### 1 Select [Print] from the [File] menu.

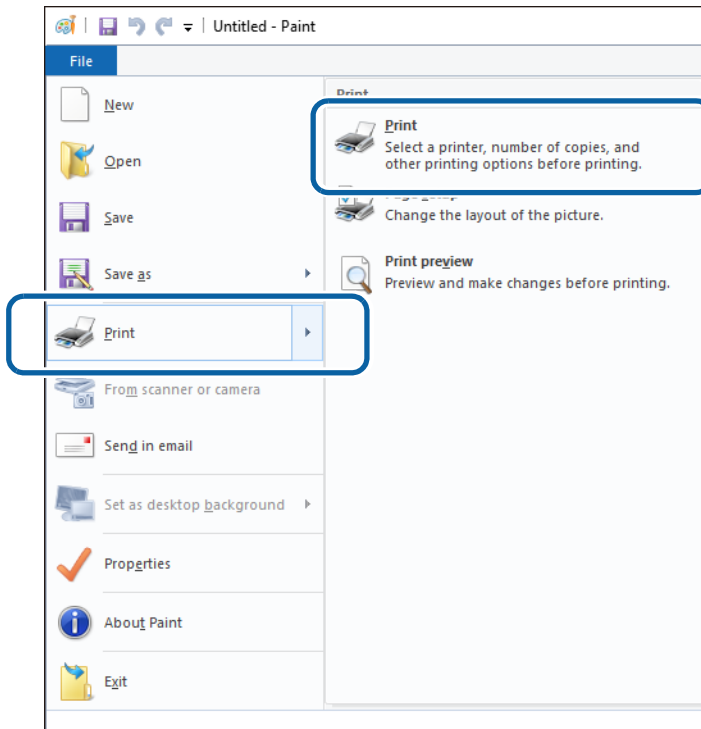

#### 2 In the "Print" window, select the target printer and then click [Preferences]. The printer driver print settings window is displayed.

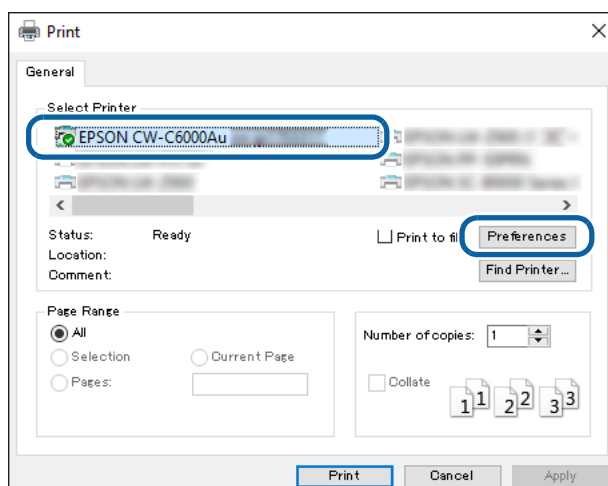

### 3 Check the print settings.

Check that the settings such as the selected media (paper) are the same as those you made at "Changing the Default Settings of the Printer Driver" on page 141. When finished checking the settings, go to the next step.

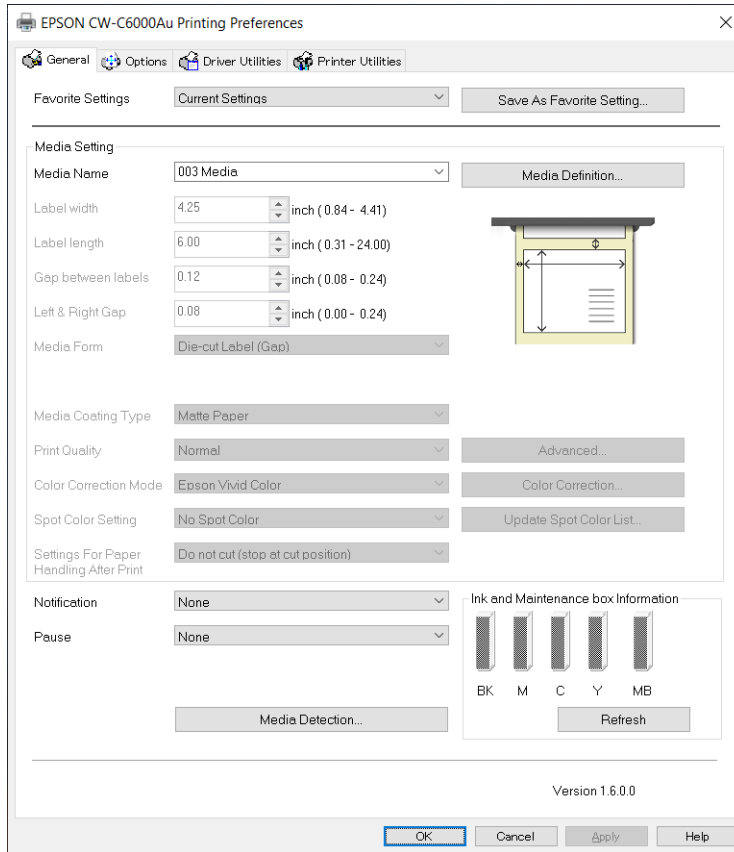

## 4 Select the [Driver Utilities] tab, and then click [Driver Preferences].

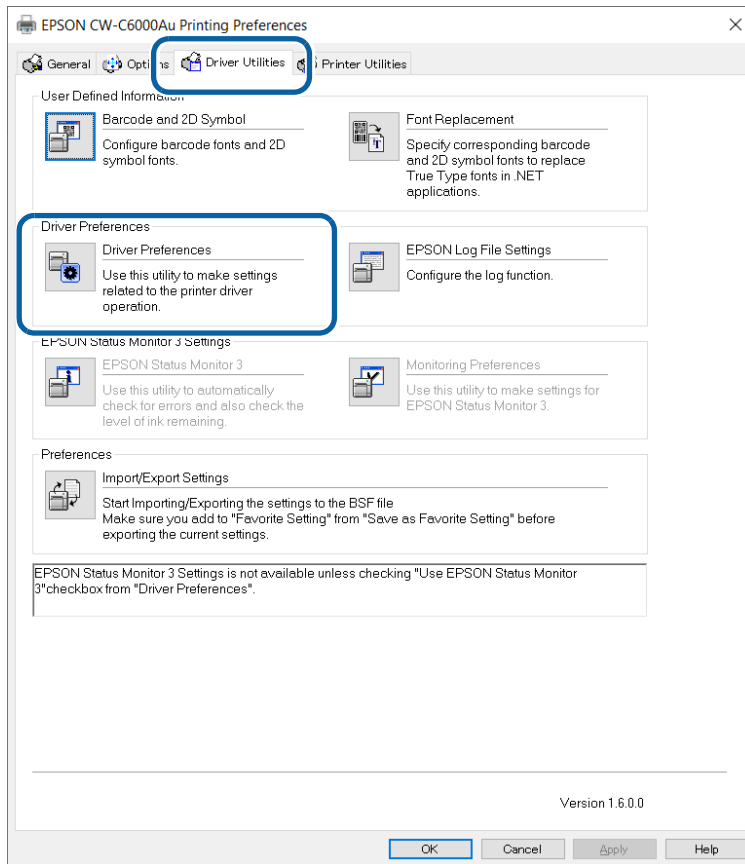

## 5 On the “Driver Preferences” window, check that the check box for [Shared Print mode] has been selected.

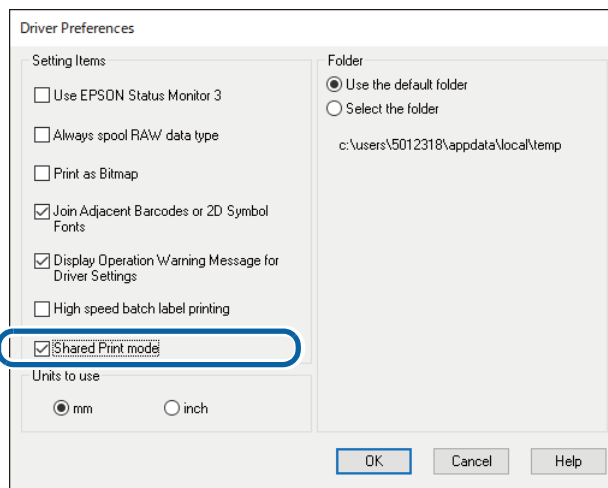

## ❑ Checking the Settings from [Devices and Printers]

- 1 Open [Devices and Printers].
- 2 Right-click on the target printer, and then click [Printing preferences].  
The printer driver print settings window is displayed.



### 3 Check the print settings.

Check that the settings such as the selected media (paper) are the same as those you made at "Changing the Default Settings of the Printer Driver" on page 141. When finished checking the settings, go to the next step.

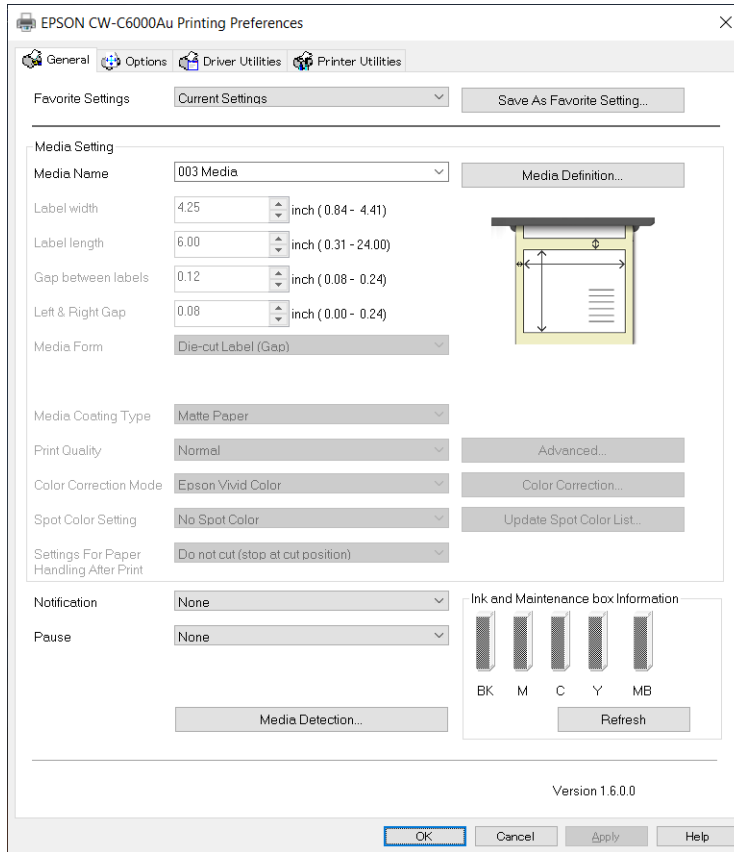

#### 4 Select the [Driver Utilities] tab, and then click [Driver Preferences].

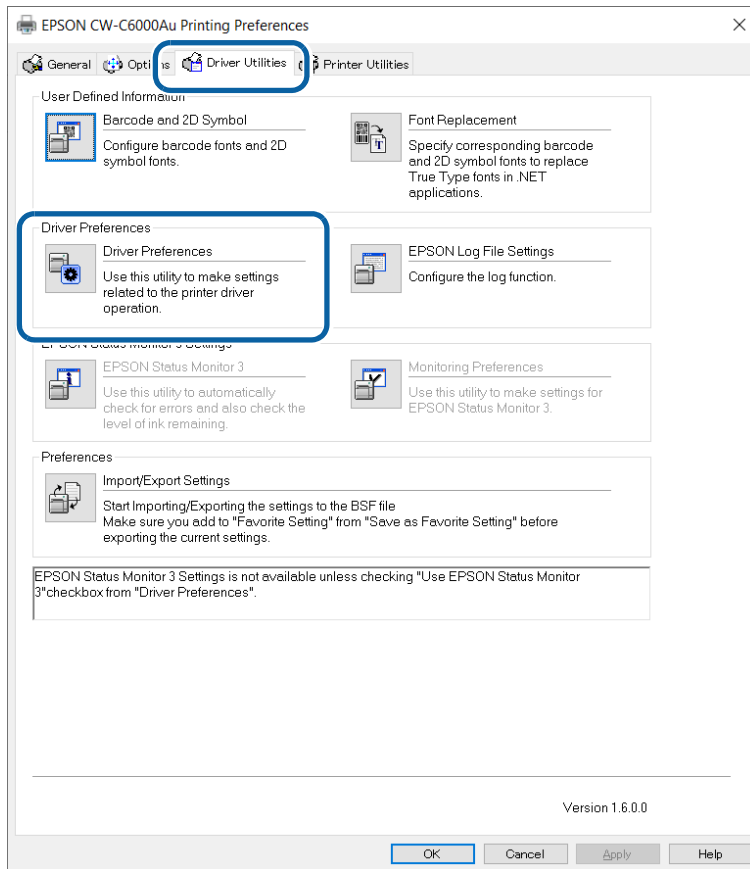

#### 5 On the “Driver Preferences” window, check that the check box for [Shared Print mode] has been selected.

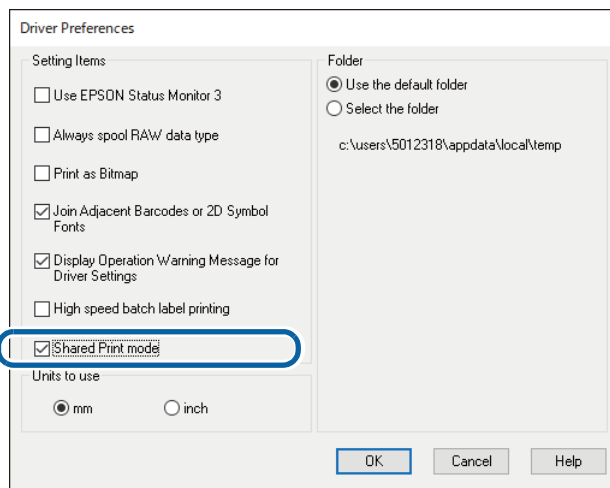

- 6 Click [Cancel] to close the “Driver Preferences” window and return to the previous print settings window.
- 7 Click [Cancel] or click [X] at the upper right corner to close the print settings window.

**IMPORTANT**

Do not click [OK] to close the print settings window that was displayed from [Devices and Printers] on a client computer. If you click [OK], the settings are saved on the client computer and the link with the server computer is disconnected.

## Restrictions on using PrinterSetting

Depending on configuration of your system, starting PrinterSetting (Printer Settings Utility) from the "Printer Utilities" tab may be disabled.

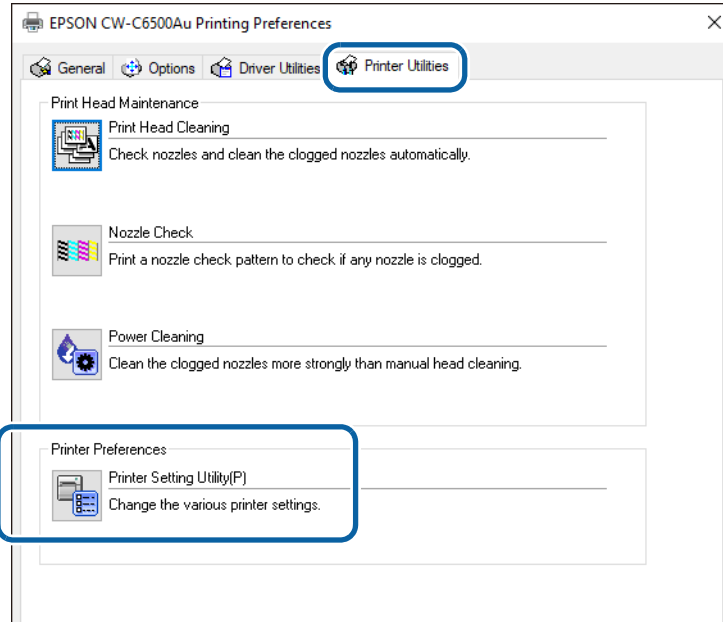

The table below shows system configuration examples and their restrictions on using PrinterSetting.

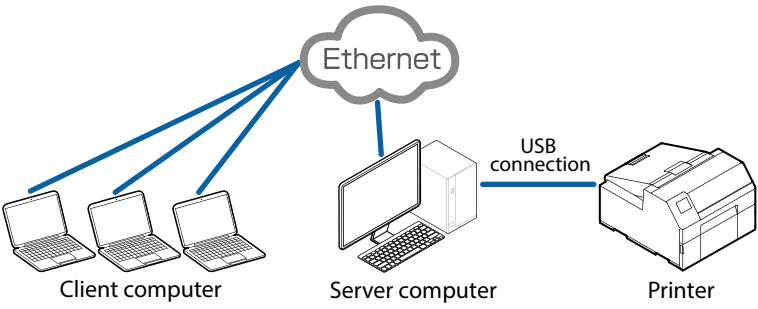
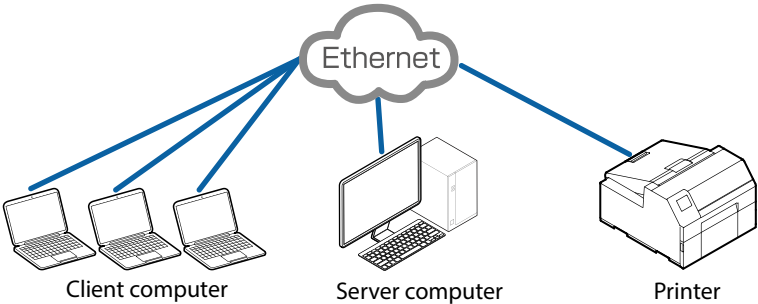
System Configuration	Starting PrinterSetting	
	Server Computer	Client Computer
<p>The printer is connected to the server computer via USB. The server and the client computers are connected via Ethernet.</p> 	Possible	Not possible
<p>The printer, the server, and the client computers are connected via Ethernet.</p> 	Possible	Possible after installing PrinterSetting application

## Setting EPSON Status Monitor 3

EPSON Status Monitor 3 displays a pop-up window to inform you specified paper type and ink levels when you start printing. In addition, if a fatal error occurs, it displays an error window.

It is disabled by default.

### Enabling/Disabling EPSON Status Monitor 3

By default, EPSON Status Monitor 3 is disabled.

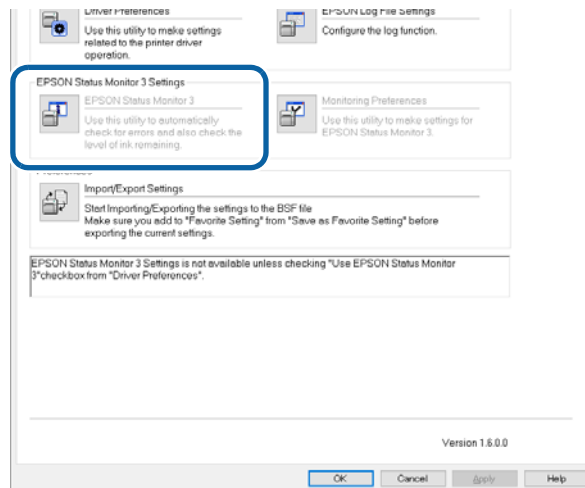

Follow the procedure below to enable EPSON Status Monitor 3.

- 1** Turn the printer on.
- 2** Open the printer driver window.
- 3** Select the [Driver Utilities] tab and then click [Driver Preferences] in the Driver Preferences field.
- 4** The Driver Preferences window appears. Select the check box for [Use EPSON Status Monitor 3], and then click [OK].

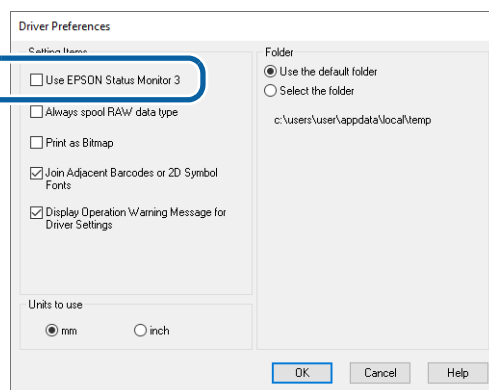

- 5** In the [EPSON Status Monitor 3 Settings] field on the [Driver Utilities] window, [EPSON Status Monitor 3] and [Monitoring Preferences] are displayed.

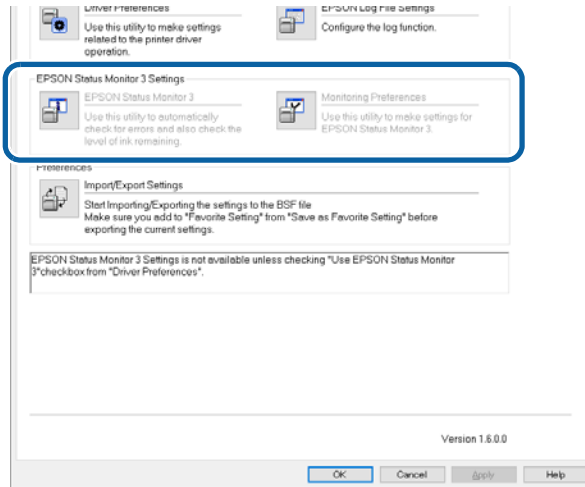

## Using EPSON Status Monitor 3

When EPSON Status Monitor 3 is enabled, the following functions become available.

- A window to inform you the printer status and ink levels is automatically displayed when you start printing.
- When an error occurs during printing, the error information is displayed.  
If an error occurs on the printer while it is not printing, EPSON Status Monitor 3 does not start.
- You can start EPSON Status Monitor 3 anytime by clicking its icon on the task bar.  
For information on how to display the icon, refer to ["Displaying the Icon" on page 163](#).

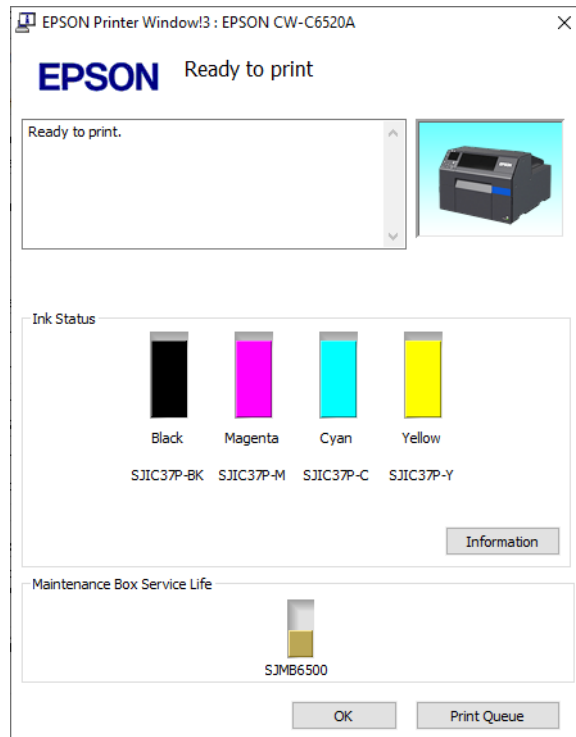

EPSON Status Monitor 3 window



Icon on the task bar

- You can set the following in the [Monitoring Preferences] settings.  
Display the EPSON Status Monitor 3 icon on the task bar.  
(See "Displaying the Icon" on page 163.)

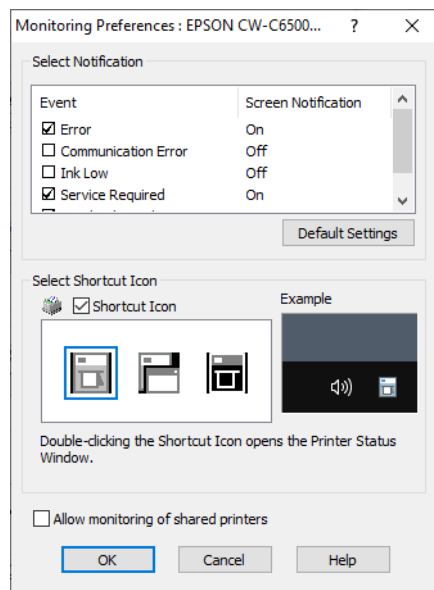

## Error Notification Settings

Follow the procedure below to change the error notification settings of EPSON Status Monitor 3.

- 1 Turn the printer on.**
- 2 Open the printer driver window.**
- 3 Select the [Driver Utilities] tab and then click [Monitoring Preferences].**  
If you have not enabled EPSON Status Monitor 3, [Monitoring Preferences] is not displayed. Enable EPSON Status Monitor 3 referring to "[Enabling/Disabling EPSON Status Monitor 3](#)" on page 158.
- 4 The Monitor Preferences window appears. Select the check boxes for the items that you want to be notified, and then click [OK].**

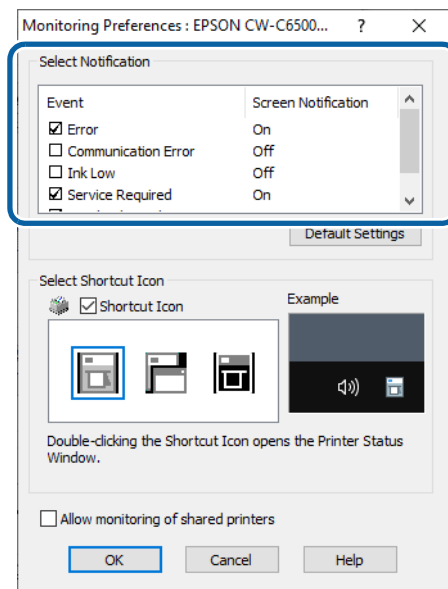

- Error: When paper/ink replacement is required (Default: Screen Notification [On])
- Communication Error: When the printer power is off (Default: Screen Notification [Off])
- Ink Low: When the ink amount is low (Default: Screen Notification [Off])
- Service Required: When a printer error occurs (Default: Screen Notification [On])
- Nozzle Clogged Warning: When the nozzles get clogged (Default: Screen Notification [On])

## Displaying the Icon

You can set to show the icon on the task bar, and check the printer status by clicking the icon. The icon is not displayed by default. Follow the procedure below to display the icon.

- 1 Turn the printer on.**
- 2 Open the printer driver window.**
- 3 Select the [Driver Utilities] tab and then click [Monitoring Preferences].**
- 4 The Monitor Preferences window appears. Select the check box for [Shortcut Icon], and then select an icon image you want to display on the task bar. Click [OK].**

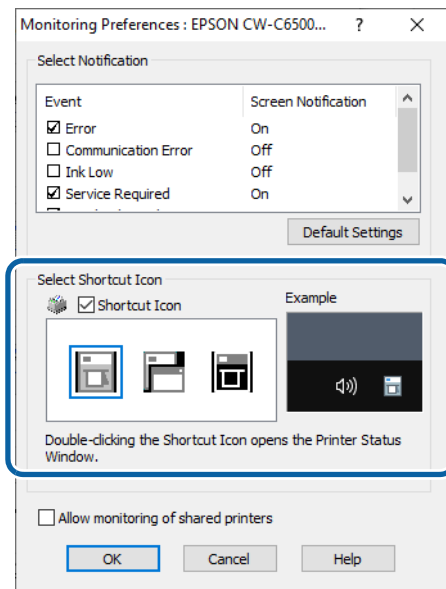

## Restrictions on Using the Printer Driver

- Keep the Bidirectional Printing function enabled. It can be set in [Advanced] that is a sub menu of [Print Quality] in [Media Settings].
- The printer driver does not support printing a background image.
- To print multiple print jobs in time order, disable [Print spooled document first]. If the printer driver receives multiple print jobs with [Print spooled document first] enabled, the print jobs may not be printed in time order.

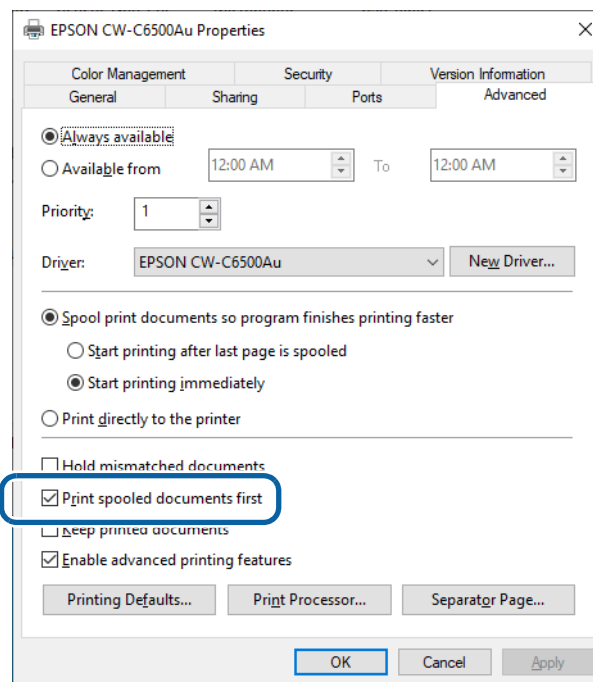

- When using Epson printer driver, do not change the control prefix, the format prefix, and the delimiter string that are included in ESC/Label command from their defaults. If you change them, printing will not be performed or result in producing unintended printouts. For their default settings, see "[Operation Panel Settings](#)" on page 229 and find [Printer Settings] - [Print Settings] - [Command Character].

## Printer Driver Isolation

Printer Driver Isolation allows for the printer driver to be executed using a different process from the process executing the print spooler, thus improving reliability of the Windows print service.

Follow the procedure below to perform isolation.

### 1 Select [Start] - [Windows Administrative Tools] - [Print Management].

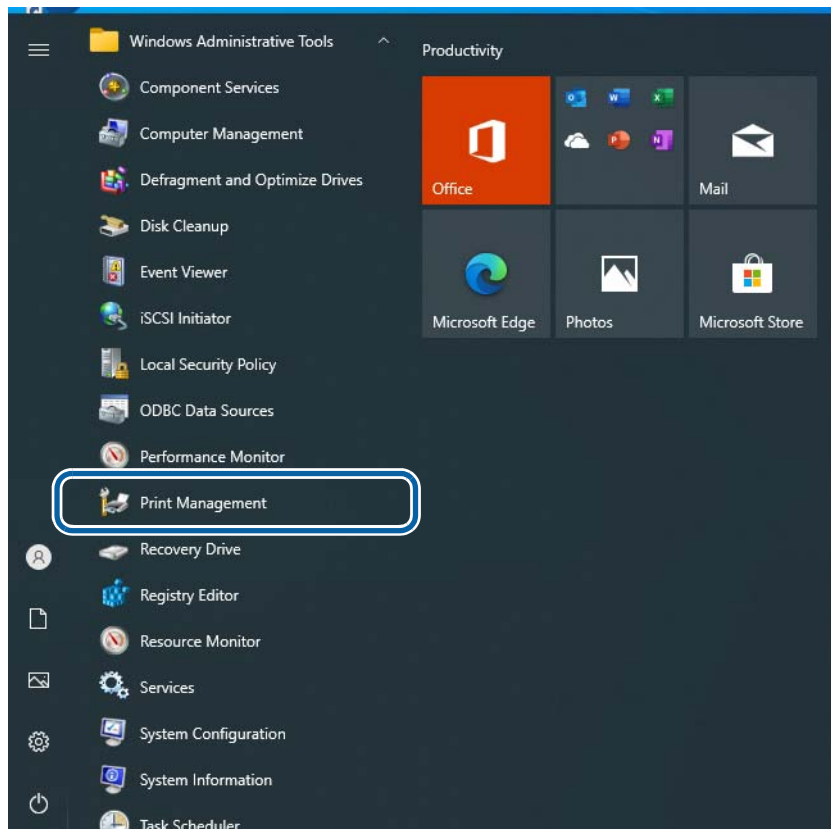

## 2 From [Driver Name], select [EPSON CW-C6000Au].

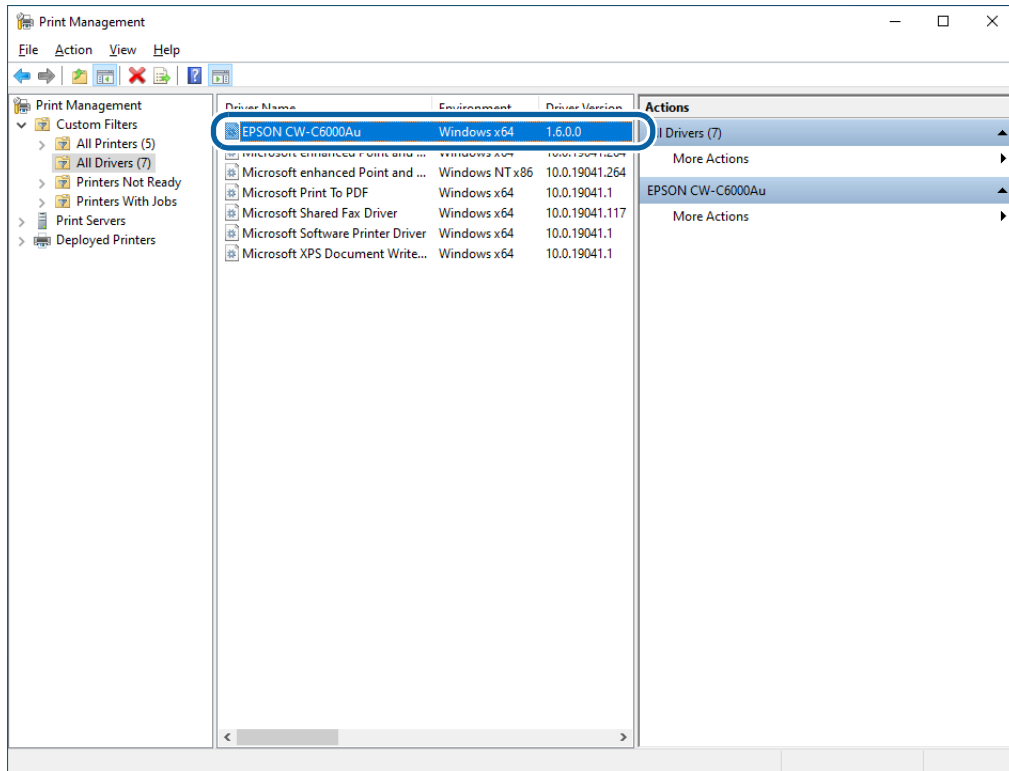

In this case, the registered name is EPSON CW-C6000Au.

## 3 Select [Actions] - [More Actions] - [Set Driver Isolation] - [Isolated].

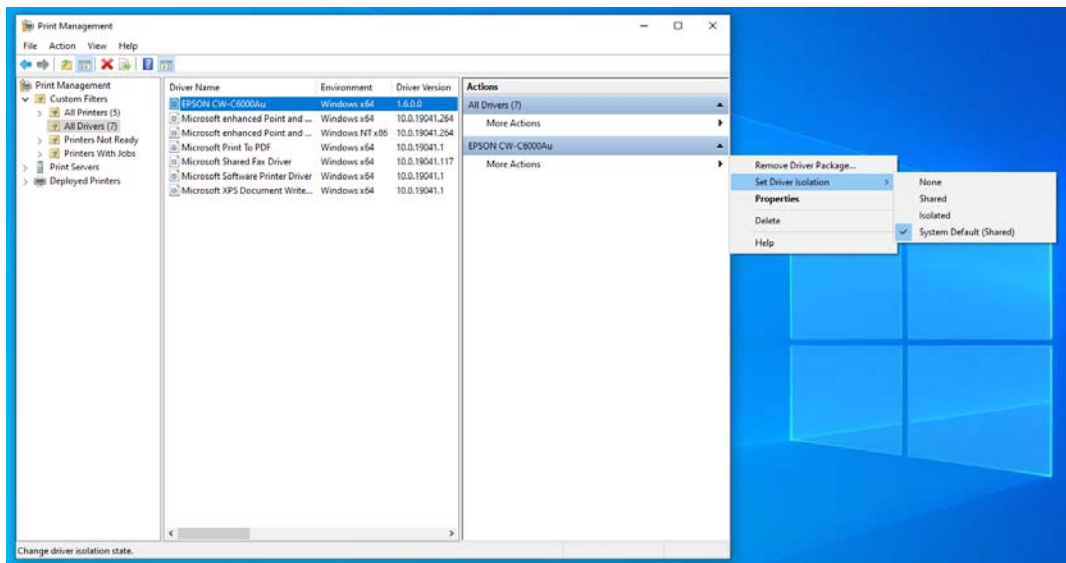

## Printer Driver for Mac

This chapter describes how to operate the printer driver for Mac.

The printer driver is software to control the printer in accordance with the print instructions of application software.

Setting the print settings in the printer driver screen enables you to obtain the best print results. Furthermore, you can also use the utilities to check the printer status and perform maintenance.

### Basic Procedure for Printing

- 1 Turn on the printer, and then load paper in the printer.** (["Opening the Paper Cover" on page 50](#))
- 2 Create data to print on an application software, then select the [File] menu and click [Print].**

The following screenshots are from Preview of Mac OS X.

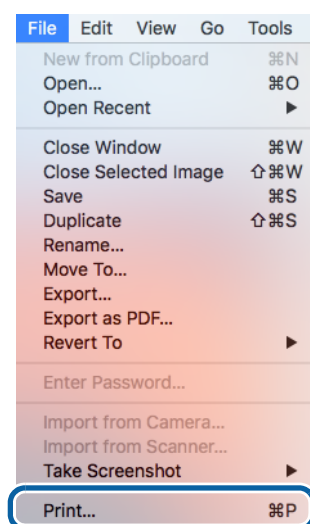

- 3 Click [Show Details] (or ) on the bottom of the screen.

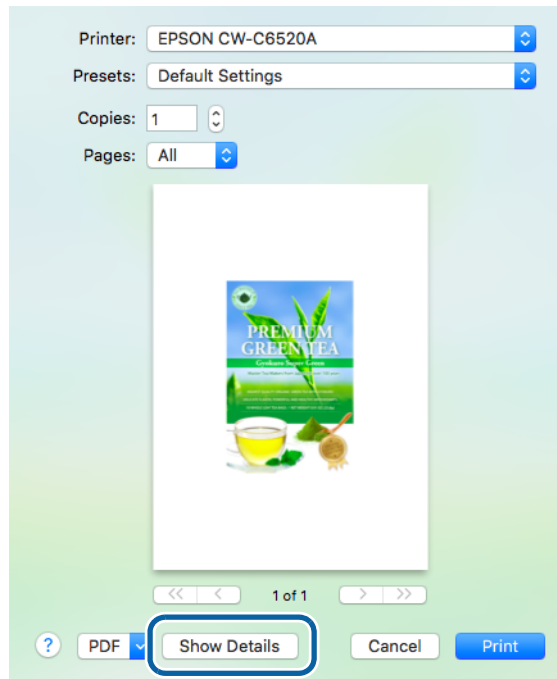

If page settings are not displayed in the print dialog, click the “page settings” option (e.g., Page Setup) in the File menu.

- 4 Check that this printer is selected, and then set the paper size. Select [Custom] to set a custom paper size.

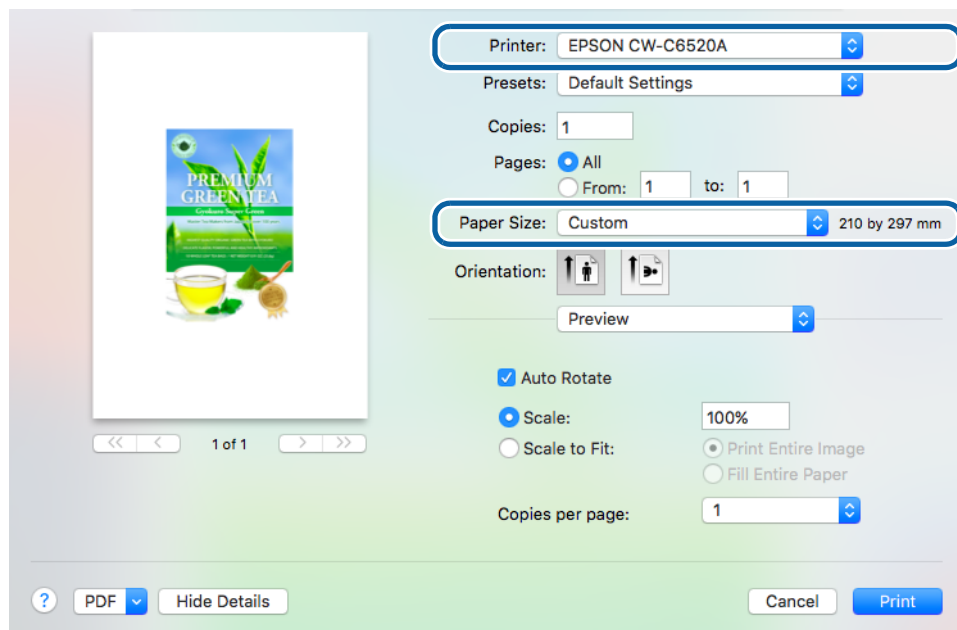

## 5 Click [+] to add a new set of paper size settings.

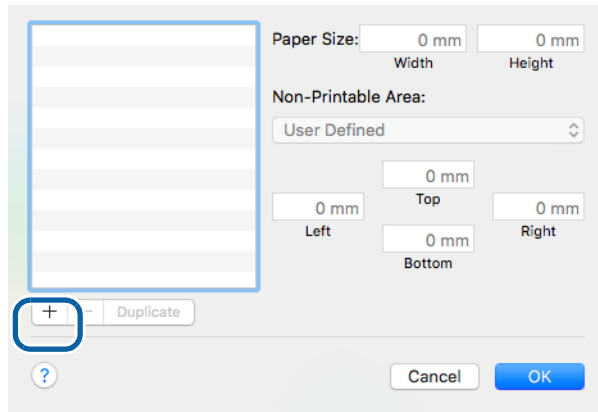

## 6 Enter paper size and make the margin setting of the printer.

Paper Size: Enter label size.

Non-Printable Area: Enter "0" in all the left, right, top and bottom fields.



### IMPORTANT

The paper size set in the Mac driver may not match the paper size displayed on the operation panel of the printer.

Example 1) When printing 15.0 mm (0.59 inches) width labels from Mac driver

- Setting value for width (Mac driver): 15.0 mm (0.59 inches)
- Setting value for width (operation panel): 14.8 mm (0.58 inches)

Example 2) When printing 212.0 mm (8.35 inches) height labels from Mac driver

- Setting value for height (Mac driver): 212.0 mm (8.35 inches)
- Setting value for height (operation panel): 211.7 mm (8.33 inches)

If setting the paper size, check the value displayed on the operation panel first.

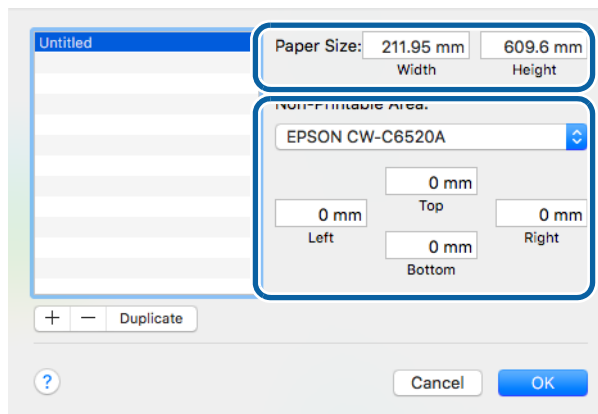

## 7 Click [Untitled] and enter a name for the custom size, and then click [OK].

The new paper size is applied to the printer driver.

## 8 Change the other settings to make them suitable for your label paper.

The following introduces setting menus that are unique to the printer. For the explanation of the other menus, refer to the Help.



- To change the paper source setting of the printer, change it using Epson Label Printer Utility. ("[Epson Label Printer Utility](#)" on page 175)
- You can change the default [Media Coating Type] setting of the printer driver following the procedure below.
  1. From the Apple menu, select [System Preferences] - [Printers & Scanners].
  2. Select the printer, and then click [Options & Supplies] - [Option].
  3. Change the setting.
- If setting menus described here are not displayed in the list, the dedicated printer driver for this printer has not been added.  
Add the dedicated printer driver following the procedure in "[Selecting the Dedicated Printer Driver](#)" on page 172.

### 1 Print Settings

Select the type of paper you use. For the other settings, refer to the Help.



#### CAUTION

When printing on die-cut labels, set [Media Saving] to [No Saving]. Setting to the other option may cause the print position to shift.

### 2 Color Options

This menu is enabled if you have selected [EPSON Color Controls] in the [Color Matching] menu. You can adjust color settings such as brightness and saturation. For more details, refer to the Help. For information on color correction, see "[Color Correction](#)" on page 274.

### 3 Extension Settings

You can change the following settings; auto cut setting (the auto cutter model only), buzzer (notification) setting, pause setting, ink profile, ratio of black to composite, and ink drying time. For explanation of each setting, refer to the Help.

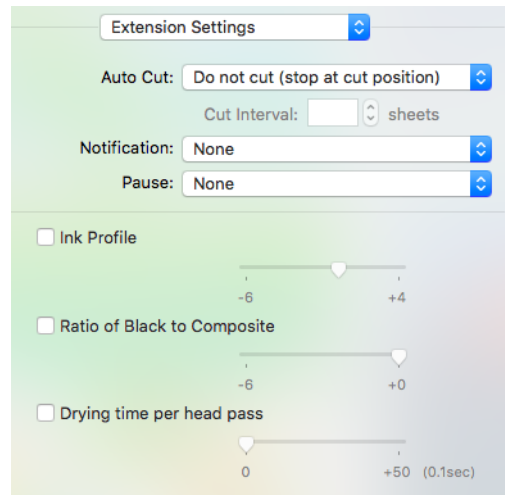

If you print without selecting the check box for [Ink Profile], [Ratio of Black to Composite], and [Drying time per head pass], those settings configured on the printer are applied. The gray out settings shown on the driver screen are not showing the actual settings, but they are default settings of the printer driver.



- You can change the driver's default setting of [Auto Cut] (the auto cutter model only), [Notification], and [Pause] following the procedure below.
  1. From the Apple menu, select [System Preferences] - [Printers & Scanners].
  2. Select the printer, and then click [Options & Supplies] - [Option].
  3. Change the setting.
- If you increase the ratio of black ink, be careful not to touch the label surface immediately after printing because ink can adhere to your fingers.
- Cautions for when [Label length] is set to a value less than 15.0 mm (0.59 inches)
  - Auto cutting is not possible because a paper jam may occur.
  - You can select all three [Cut] options below in [Settings For Paper Handling After Print].
    - Cut (after printing last label)
    - Cut (at specified label)
    - Cut (after last page of collate page)
  - If you have selected [Cut (at specified label)] for [Settings For Paper Handling After Print] and selected the [Collate] check box on the [Options] tab, specify the number of pages per copy in [Cut Interval]. If you have not selected the check box, we recommend specifying the number of copies in [Cut Interval].
  - When [Settings For Paper Handling After Print] - [Cut (at specified label)] - [Cut Interval] is set to "1", the driver automatically changes [Cut Interval] to "2" to reach or exceed the minimum label length that can be cut (15.0 mm (0.59 inches)). Also, to ensure that the label length does not become less than the minimum label length that can be cut (15.0 mm (0.59 inches)), "1" can no longer be set for [Cut Interval].

**9** Check the print settings, and then click [Print] to start printing.

---

## Selecting the Dedicated Printer Driver

If the menus described in “[Basic Procedure for Printing](#)” are not displayed, select the printer driver dedicated for this printer in [Printer]. The dedicated printer driver is displayed as follows.

- When connecting via USB  
EPSON CW-C6XXXX
- When connecting via a network  
EPSON CW-C6XXXX-YYYYYY  
“XXXX” is the product model number. “YYYYYY” is the last six digits of the MAC address.



Depending on the OS version, the MAC address may not be displayed even when the printer is connected via a network.

If the dedicated printer driver is not displayed in the list, add it following procedure below.

- 1** From the Apple menu, select [System Preferences] - [Printers & Scanners].
- 2** Click [+] and select [Add Printer or Scanner].
- 3** When the list of devices appears, select the dedicated printer driver and then click [Add].

## Customizing the Printer Driver

You can save frequently used sets of settings (paper size and other print settings) as Presets under a new name. This allows you to easily apply exactly the same settings repeatedly.

### Saving Settings as Preset

- 1 Make the paper size and other print settings to save them as a preset.
- 2 From the [Presets] menu, select [Save Current Settings as Preset].

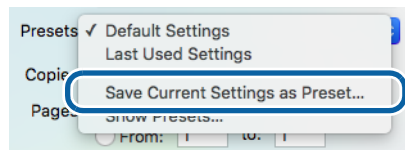

If you want the preset you last used to be selected the next time you print, open [Show Presets...] and check to make sure that the check box for [Reset Presets Menu to "Default Settings" After Printing] is not selected.

- 3 Enter a name, and then click [OK].

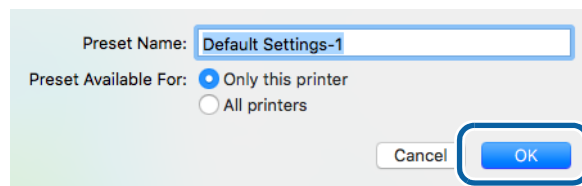

Select [All printers] in [Preset Available For] to allow selection of the preset from all printer drivers installed on your computer.

The set of settings is saved in [Presets]. You can select it from the [Presets] menu from the next time.

## Deleting from Presets

- 1 Click [Show Presets...] in [Presets] of the Print dialog box.

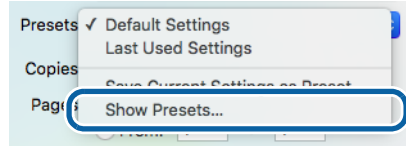

- 2 Select the preset you want to delete, click [Delete], and then click [OK].

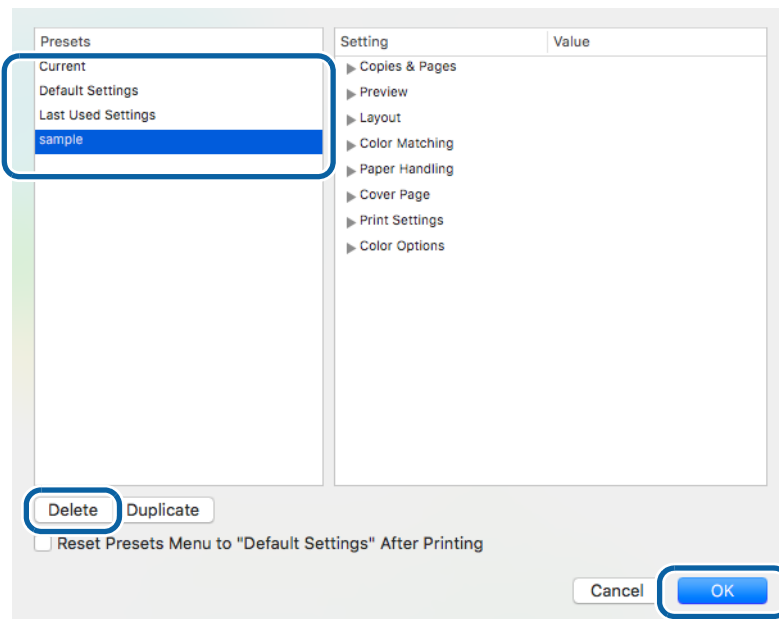

## Epson Label Printer Utility

Epson Label Printer Utility allows you to start EPSON Status Monitor, to run a nozzle check and print head cleaning, and to make adjustments. In addition, [Media Setting], [Positioning], and [Settings for Paper Handling After Print] (the peeler model only) allow you to change those settings of the printer from the computer.

- 1 From the Apple menu, select [System Preferences] - [Printers & Scanners], and then select the dedicated printer driver for this printer.
- 2 Click [Options & Supplies] - [Utility] - [Open Printer Utility].

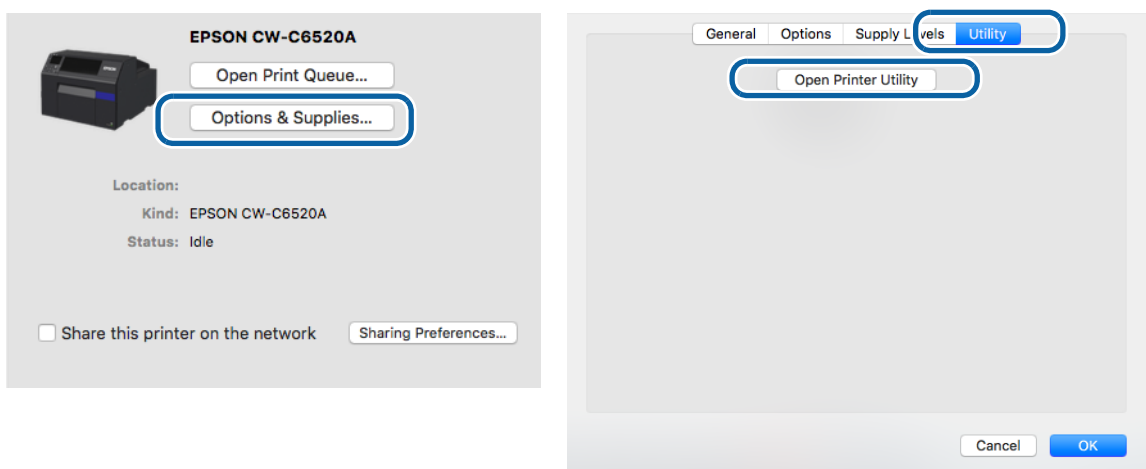

- 3 **Epson Label Printer Utility starts.**  
Click an icon of the function you want to use. The function window appears. For more details, follow the instructions displayed on the window.

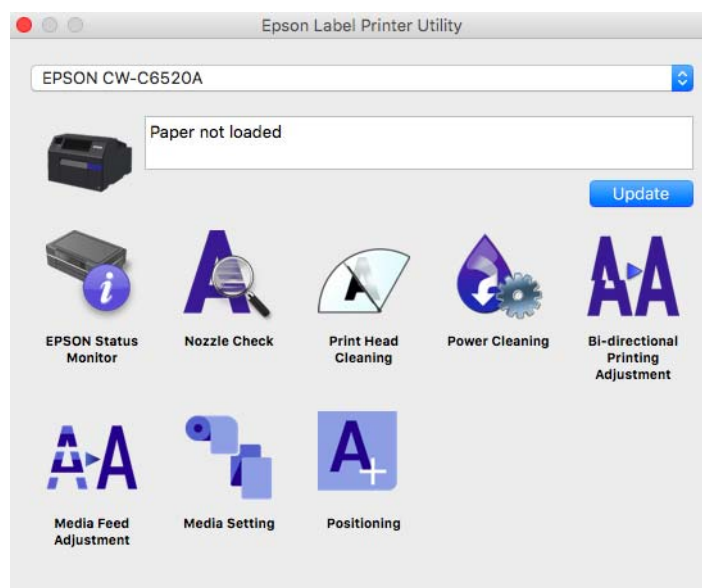

## Changing the Paper Source Setting

To change the paper source setting (internal roll or external feed), select [Media Setting] of the Epson Label Printer Utility and change the [Media source] setting.

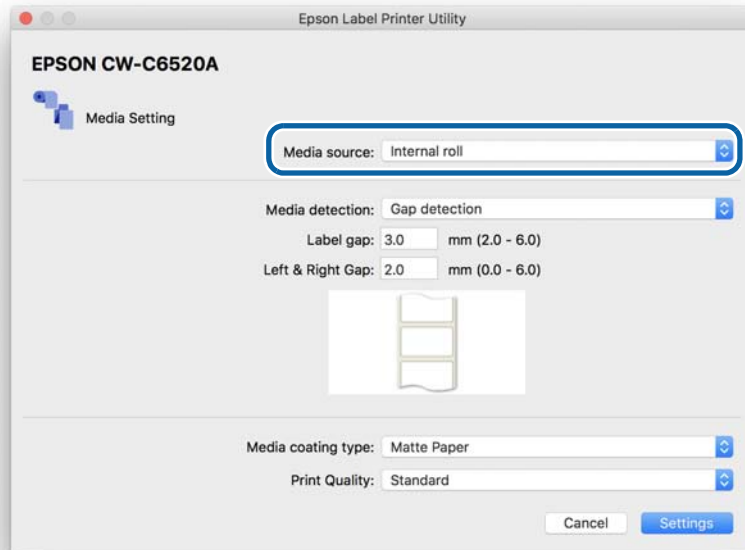

## Printer Driver for Linux

This section describes how to install the printer driver and how to configure Epson Label Printer Utility for Linux. Epson Label Printer Utility for Linux allows you to start EPSON Status Monitor, run a nozzle check and print head cleaning, make paper settings, and make adjustments such as bi-directional printing adjustment.



### About Linux Printer Driver

- Linux driver is not for end-users. It is aimed at system developers or engineers who can build a Linux based system by themselves. To operate the driver, command lines are mainly used. Rich graphical user interface such as the Windows printer driver is not provided.
- It offers minimum functions for printing.
- Basically, the same functions as Mac printer driver are provided except for some functions that cannot be achieved due to Linux OS restrictions.

The work procedure is as follows.

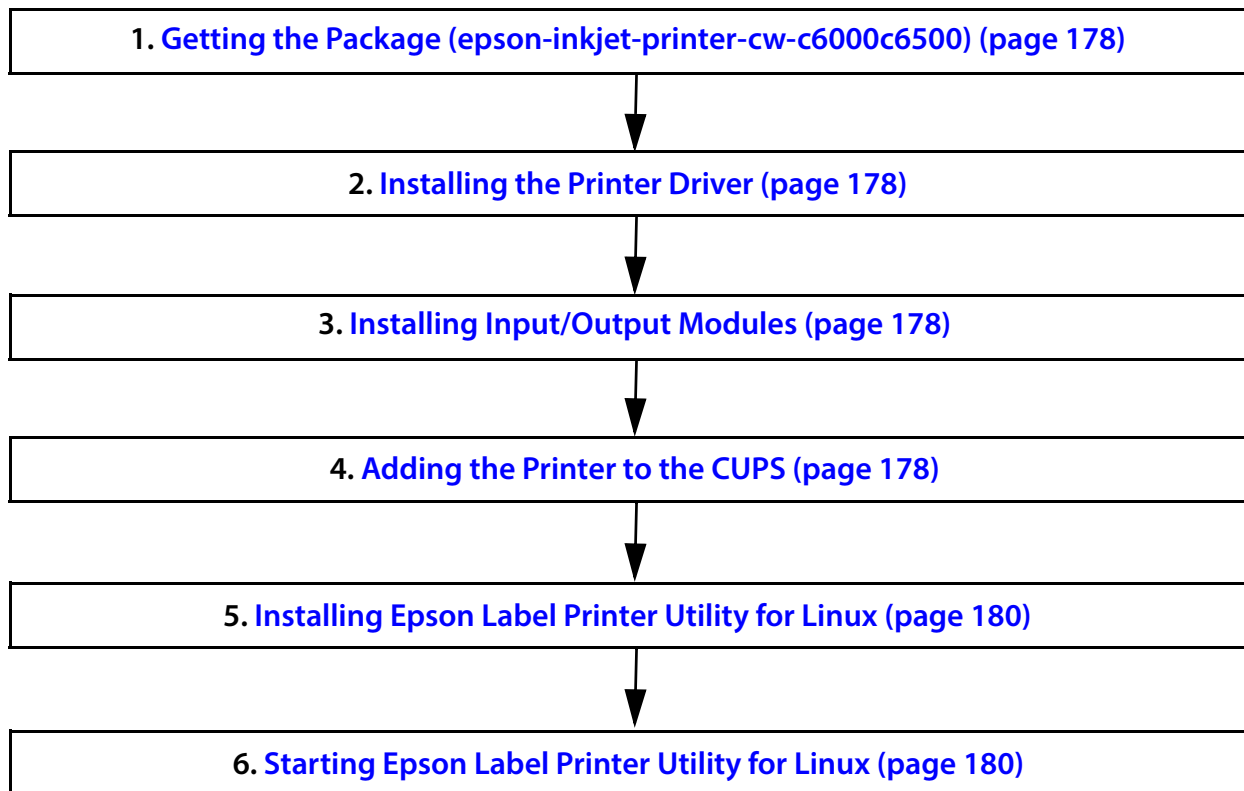

Throughout this section, command strings that follow "\$" can be executed by a login user, and command strings that follow "#" need to be executed with administrator privileges.

## Getting the Package (epson-inkjet-printer-cw-c6000c6500)

Download the latest version of the printer driver and Epson Label Printer Utility for Linux.  
For details, see "[Downloading Printer Driver, Utilities, and Manuals](#)" on page 415.

## Installing the Printer Driver

Start a terminal software, and execute a command shown below.

```
< Ubuntu 18.04>
# dpkg -i epson-inkjet-printer-cw-c6000c6500_[Arch].deb
<CentOS 7>
# rpm -i epson-inkjet-printer-cw-c6000c6500_[Arch].rpm
```

## Installing Input/Output Modules

Execute a command shown below.

**1.0.0** indicates version of the software. Correct it according to the file you use.

```
< Ubuntu 18.04>
# dpkg -i epson-printer-io-community-1.0.0.deb
< CentOS 7>
# rpm -i epson-printer-io-community-1.0.0.rpm
```

## Adding the Printer to the CUPS

The following is the procedure using a web browser.

- 1 **Access the address below.**  
<http://localhost:631/>

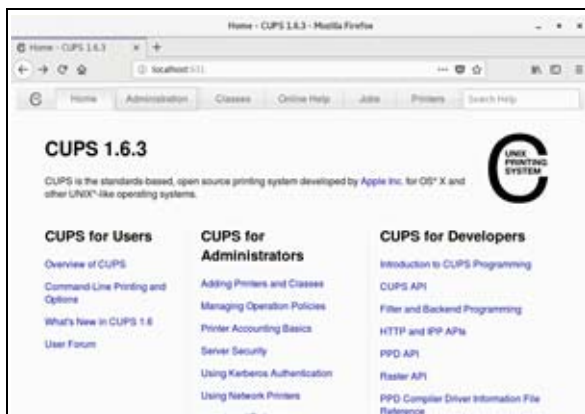

## 2 Select the [Administration] tab, and then select [Add Printer].

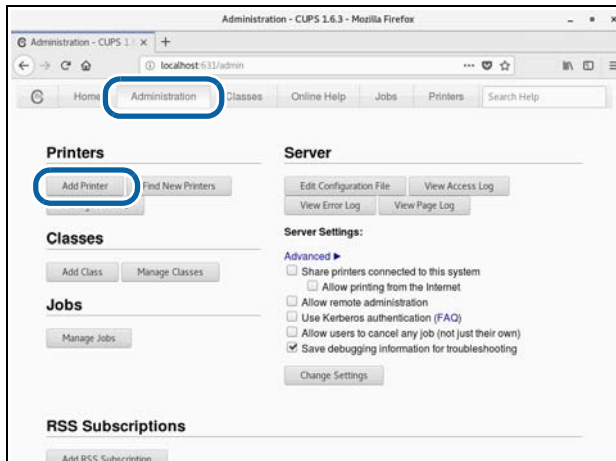

Follow the on-screen instructions. If you are prompted to enter a user name and password, enter "root" as a user name and enter an administrative password.

## 3 When a list of printers is displayed, select the printer to add.

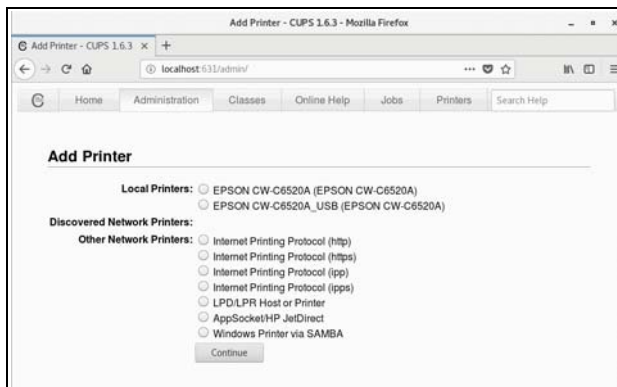

Select the [Printers] tab to see the information of the added printer.

### For USB connection

If the printer is connected to the computer using a USB cable, select the printer as described below.

In the list of printers, select the printer that is indicated with its model name followed by "\_USB" (2).



## Installing Epson Label Printer Utility for Linux

Execute a command shown below.

**1.0.0** indicates version of the software. Correct it according to the file you use.

< Ubuntu 18.04>

```
# dpkg -i epson-label-printer-utility-community-1.0.0-QT5.deb
```

< CentOS 7>

```
# rpm -i epson-label-printer-utility-community-1.0.0-QT5.rpm0
```

## Starting Epson Label Printer Utility for Linux

Epson Label Printer Utility for Linux can be started either from a command line or from Desktop Entry.

Use one of the following methods to start the utility.

### Starting from a command line

Execute a command shown below.

<Common to both Ubuntu and CentOS>

```
$ /opt/epson/epson-label-printer-utility/elpuqt &
```

### Starting from Desktop Entry

The operation method may vary by distribution, edition, flavors, and version.

The following explains how to start the utility on Ubuntu 18.04 and CentOS 7.

<Ubuntu 18.04>

Click the icon in the bottom left of the screen, and then select Epson Label Printer Utility in the displayed list. If the utility is not displayed, search for “Epson” to find it.

<CentOS 7>

From the application menu located in the upper left of the screen, select the “Accessories” sub menu. Select Epson Label Printer Utility from the displayed list.

Epson Label Printer Utility for Linux will start.

Click an icon to display the function screen. For details, see the descriptions shown on the function screen.

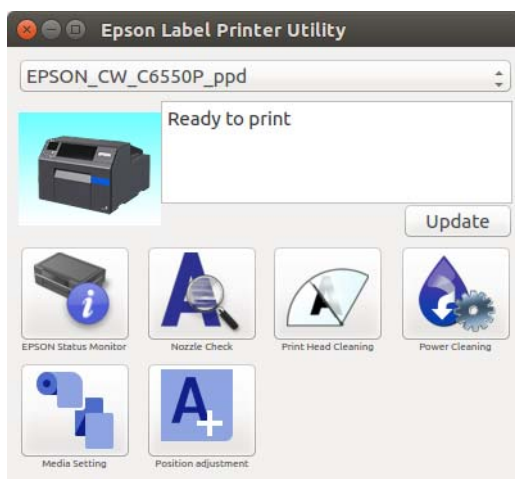

## Installing Dependent Libraries

If you are using supported distribution and have not changed the default settings, installing dependent libraries is not necessary. If you have not installed default full package, Epson Label Printer Utility for Linux may not work due to lack of dependent libraries.

The dependent libraries and the required package are as follows.

Dependent file	Dependent package (Ubuntu 18.04)	Dependent package (CentOS 7)
libQtCore.so.5	libqt5core5a	qt5-qtbase
qt5-qtbase	libqt5gui5	qt5-qtbase-gui
libQtWidgets.so.5	libqt5widgets5	
libcups.so.2	libcups2	libcups2
libcupsimage.so.2	libcupsimage2	
libpng15.so.15	(Not used)	libpng15
libpng16.so.16	libpng16-16	(Not used)
libusb-1.0	libusb-1.0-0	libusb

If an error occurs due to lack of dependent libraries when starting Epson Label Printer Utility for Linux, install the necessary file.

Example: Qt5 is not found on Ubuntu 18.04

Execute a command shown below.

```
# apt install libqt5widgets5
```

## Exiting Epson Label Printer Utility for Linux

Use one of the following methods to exit the utility.

- Click “X” on the screen.
- Press [Alt] and [F4] at the same time.
- Click [Exit Epson Label Printer Utility].

## Uninstalling Printer Driver, Epson Label Printer Utility for Linux

### ❑ Printer driver

Start a terminal software, and execute a command shown below.

```
< Ubuntu 18.04 >
```

```
# dpkg -P epson-inkjet-printer-cw-c6000c6500
```

```
< CentOS 7 >
```

```
# rpm -e epson-inkjet-printer-cw-c6000c6500
```

□ Epson Label Printer Utility for Linux

Start a terminal software, and execute a command shown below.

< Ubuntu 18.04 >

```
# dpkg -P epson-label-printer-utility-community
```

```
# dpkg -P epson-printer-io-community
```

< CentOS 7 >

```
# rpm -e epson-label-printer-utility-community
```

```
# rpm -e epson-printer-io-community
```



## Printing from SAP System

CW-C6000/6500 Series allow you to print from a SAP system which is one of Enterprise Resource Planning systems.

### Methods of Printing from SAP System

There are the following three methods to print from SAP System.

To know the data flow and component of each methods, see ["SAP System Printing Data Flow" on page 184](#).

Printing Method	Overview
Direct printing  <a href="#">"Direct Printing" on page 185</a>	<p>This is a standard method for printing from SAP System. Printing operation is completed in the closed SAP system environment, where basically only programs provided by SAP company are used. Printer driver provided by the system as a SAP standard printer driver is used. Since this Direct printing system is highly reliable and stable, it is generally used for remote batch high-volume printing.</p> <p>Printer vendors are required to provide only a file called "Device type" which describes ability of their printer. However, if the printer uses a printer control language that is not supported by the SAP printer driver, the vendor is also required to provide ABAP driver. ABAP driver converts the printer control language supported by the SAP printer driver into the language supported by the printer.</p>
Indirect printing  <a href="#">"Indirect Printing" on page 185</a>	<p>Printing operation is completed through a Windows computer located outside the SAP system.</p> <p>Sprint or SAP LPD software provided by SAP company installed on the Windows computer receives print data from the SAP system, converts the data into Windows print system format, and then prints the data by sending it to a Windows printer driver provided by the printer vendor. Therefore, this method allows you to print on various Windows compatible printers. However, because of using software located outside the SAP system, frequency of problem may increase or printing speed may decrease compared to Direct printing.</p>
High Volume Printing  <a href="#">"High Volume Printing" on page 186</a>	<p>This method is for printing GHS labels that contain color pictograms. The data is sent from EHS (Environment, Health and Safety Management) and GLM (Global Label Management) and printed through WWI (Windows Word processor Integration) Server.</p> <p>HVP driver provided by SAP company is used, and for specifying the target printer, plug-in provided by the printer vendor is used. The amount of data for printing is smaller than that for normal Windows printer driver.</p>

### SAP System Printing Data Flow

The flowchart below shows the data flow and component of each printing methods.

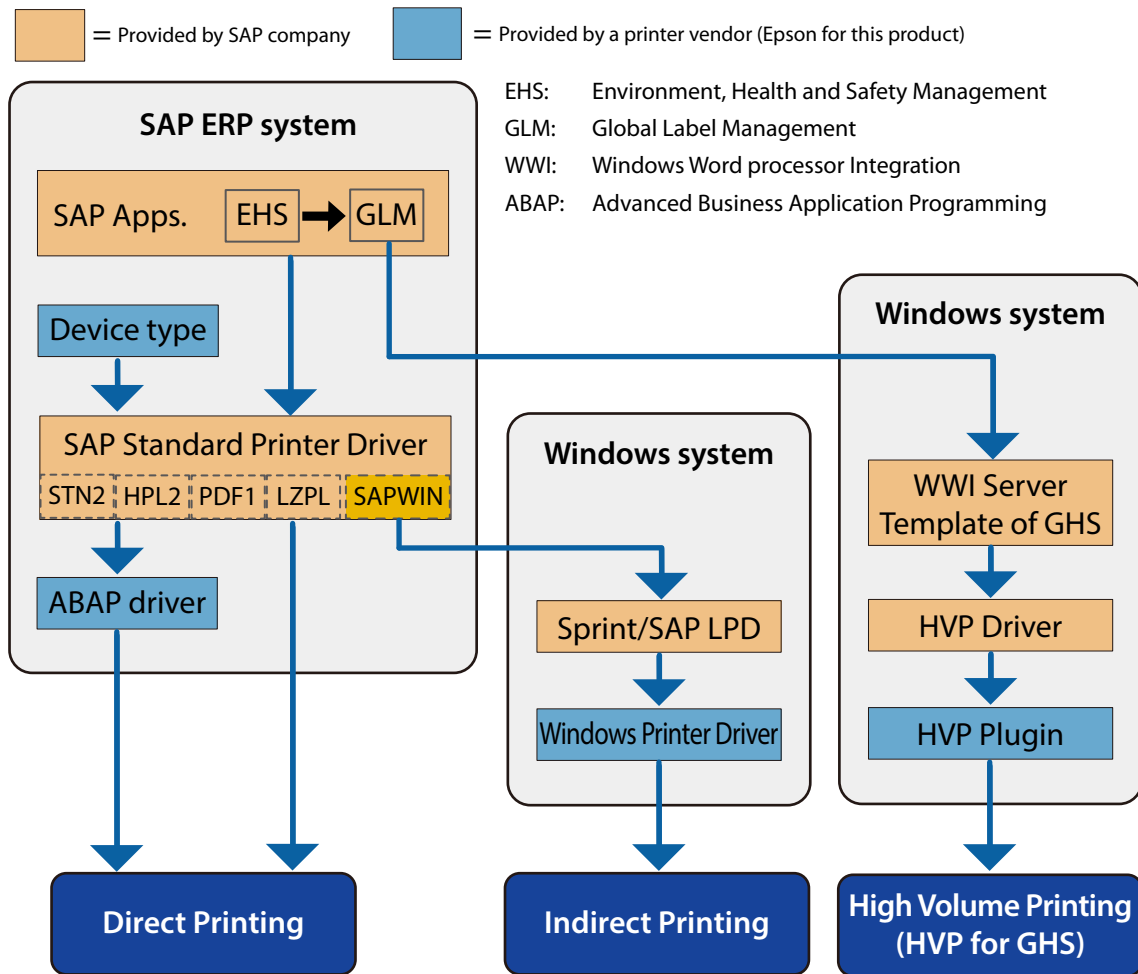

The SAP Standard Printer Driver used for Direct printing supports the following printer control languages.

Name	Supported Printer Control Languages
STN2	Line Printer Driver 2
HPL2	HP PCL5
LZPL	Zebra ZPL2
PDF1	Adobe PDF
POST2	Adobe PostScript
ESCPAG	EPSON ESC/Page
PRES	Kyocera PRESCRIBE

## Direct Printing

Because this method uses the SAP standard printer driver and completes printing operation in the closed SAP system environment, Epson cannot provide any information about how to use the system. Consult information provided by SAP company\*.

This section explains about files provided by Epson that is necessary for Direct printing using CW-C6000/6500 Series, and installation method.

- \* The method for printing from the SAP system is common to all printers regardless of difference of vendor. SAP Note that describes all necessary information is public to all SAP users. A SAP user account is required to acquire the SAP Note.

## Necessary Files

### Device type

Use one of the following files.

- YEPCW6X.PRI: For languages other than Japanese
- YEPCW6XJ.PRI: For Japanese

### ABAP driver

The driver consists of the following two files. Use the two files as a pair.

- K00XXXX.PVD
- R00XXXX.PVD



The printer control language for CW-C6000/6500 Series is ESC/Label. Since the SAP printer driver does not support the language, both the Device type and the ABAP driver are required. For information about printer control languages supported by the SAP printer driver, see "[SAP System Printing Data Flow](#)" on page 184.

## How to Install

For instructions on how to install the printer files, see the following SAP Note.

- SAP Note 2867759
- SAP Note 1103422

SAP web site URL: <https://launchpad.support.sap.com>

## Indirect Printing

Install the latest Epson Windows printer driver on a Windows computer for using this method.

For instructions on how to use the driver, see "[Printer Driver for Windows](#)" on page 75.

For instructions on how to install and use the SAP software, Sprint or SAP LPD, follow the instructions provided by SAP company.

## High Volume Printing

This method uses HVP driver provided by SAP company. Epson provides a plug-in file for the HVP driver.

Plug-in file name: HVP Plug in for CW C60x0/C65x0

For instructions on how to perform high volume printing, see “CW-C6000 Series/CW-C6500 Series HVP Plug in Module User’s Guide” that comes with the plug-in.

## PrinterSetting (Windows)



If you start PrinterSetting with user privileges, you may not be able to change the settings while the printer driver or other software is communicating with the printer.

PrinterSetting is a utility that allows you to configure the printer settings. The following shows a summary of available settings with PrinterSetting.

Item	Description	Page
Media settings*	Allows you to make settings of paper to be used on the printer.	<a href="#">Page 190</a>
Layout settings*	Allows you to make paper layout settings. User-defined layout settings that include paper form and print area setting can be configured.	<a href="#">Page 191</a>
Position adjustment	Allows you to adjust print start position and cut position.	<a href="#">Page 193</a>
Print results adjustment*	Allows you to adjust colors and barcode.	<a href="#">Page 195</a>
Store data in the printer	Allows you to register images, templates, and fonts to the printer. In addition, a character code can be selected from the character code table.	<a href="#">Page 196</a>
Background image settings*	Allows you to configure a background image.	<a href="#">Page 200</a>
Print head maintenance	Allows you to run a print head cleaning or nozzle check, and make settings for periodic cleaning.	<a href="#">Page 204</a>
Detailed settings	Allows you to make detailed settings of the printer. <ul style="list-style-type: none"> <li>• Printer settings</li> <li>• Panel settings</li> <li>• Operating time settings</li> <li>• Nozzle check settings</li> <li>• Advanced settings <ul style="list-style-type: none"> <li>• Replace settings from printer using ZPL II commands</li> <li>• Favorite settings</li> </ul> </li> <li>• Initialize printer</li> </ul>	<a href="#">Page 205</a> to <a href="#">Page 224</a>
Printer information	Allows you to check the printer settings such as paper settings and layout settings, and the maintenance counter.	<a href="#">Page 225</a>
Settings save and restore	Allows you to save the printer settings and to restore the settings from the saved file.	<a href="#">Page 227</a>
Option	Allows you to change PrinterSetting preferences. A unit of length used in PrinterSetting and start up setting can be changed.	<a href="#">Page 228</a>

\* Not displayed if you start PrinterSetting from the printer driver.

## How to Start PrinterSetting

Start PrinterSetting by following the steps below.

- 1 Turn the printer on.
- 2 Click [Start] - [EPSON] - [CW-C6XXX PrinterSetting].
- 3 The Select printer window appears. Select a search target, and then click [Search].

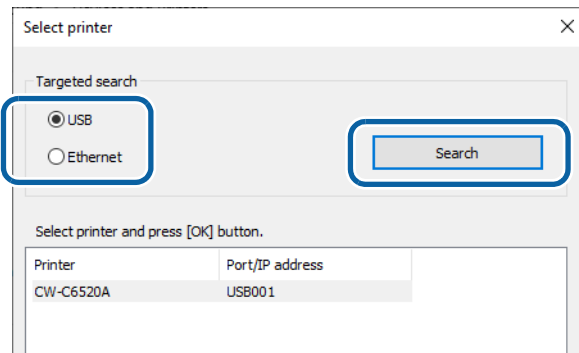

- 4 The printer is displayed in the list. Select the printer, and then click [OK].

 If the printer is connected via Ethernet, the printer may not be displayed in the list. In that case, enter an IP address of the printer.

The screenshot shows the 'Select printer' dialog box with the 'Ethernet' radio button selected. The 'Search' button is visible. Below the table, there is an 'IP address:' field with the value '192 . 168 . 192 . 168' entered. At the bottom, the 'OK', 'Cancel', and 'Help' buttons are visible.

## 5 PrinterSetting is started.

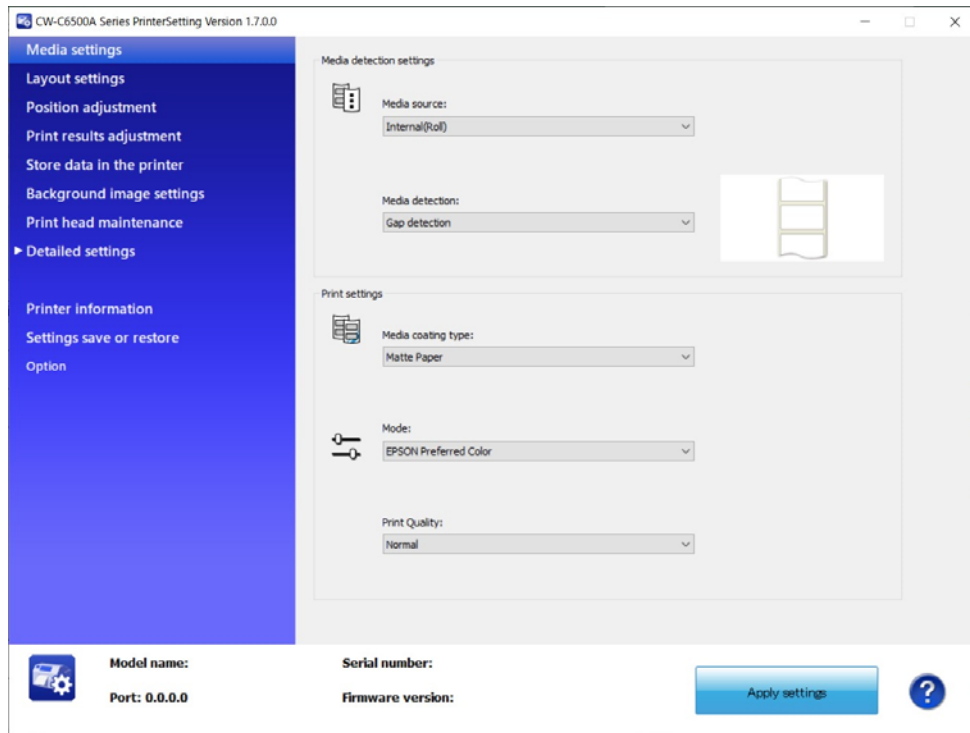

### How to Apply Settings

After you change the printer settings, click [Apply settings] to apply the changes to the printer.

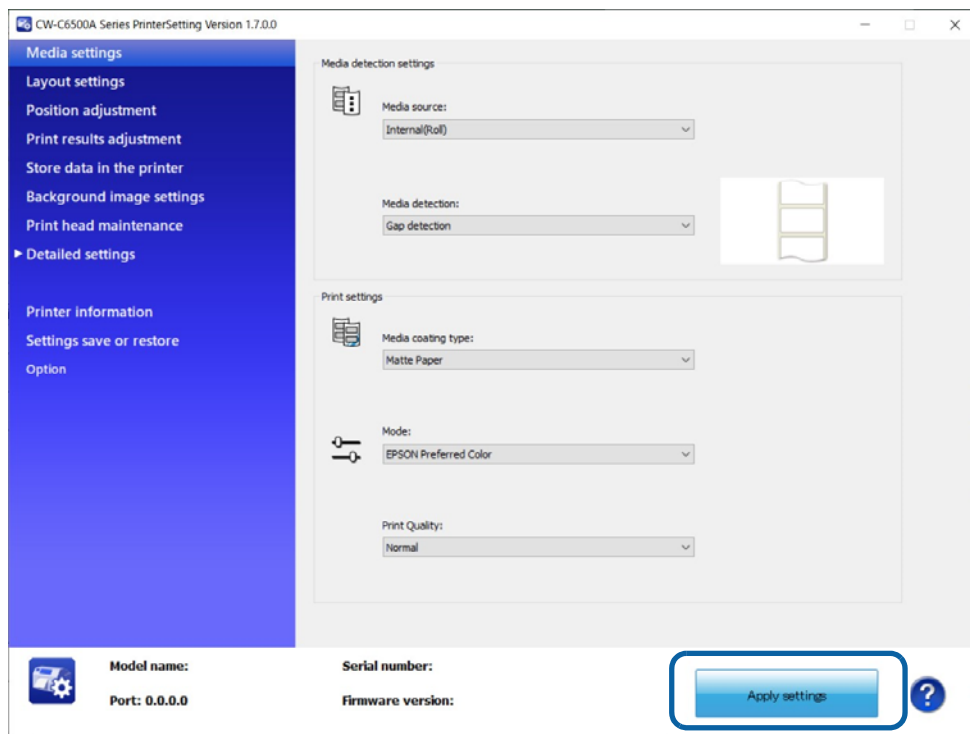

## Media settings

Allows you to make settings of paper to be used on the printer.



This is not displayed if you start PrinterSetting from the printer driver.

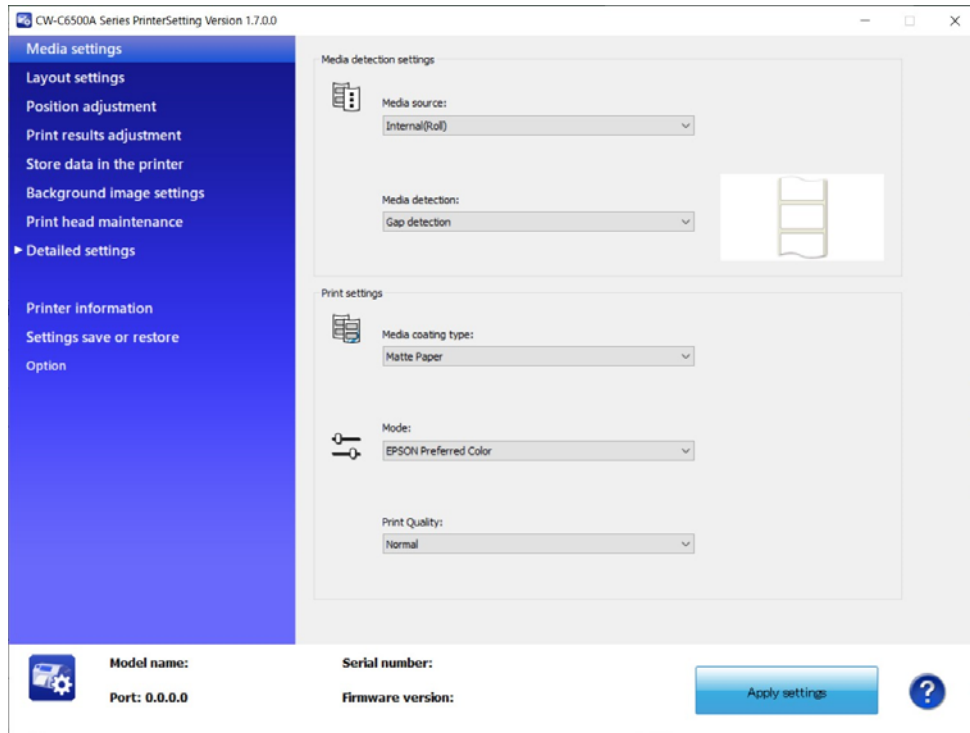

Item		Description
Media detection settings	Media source	Allows you to change the paper feed setting.
	Media detection	Allows you to set paper detection setting.
Print settings	Media coating type	Allows you to select a paper type.
	Mode	Allows you to select a Mode.
	Print Quality	Allows you to select the print quality.

## Layout settings

Allows you to change the paper layout settings and create a user-defined layout settings.



This is not displayed if you start PrinterSetting from the printer driver.

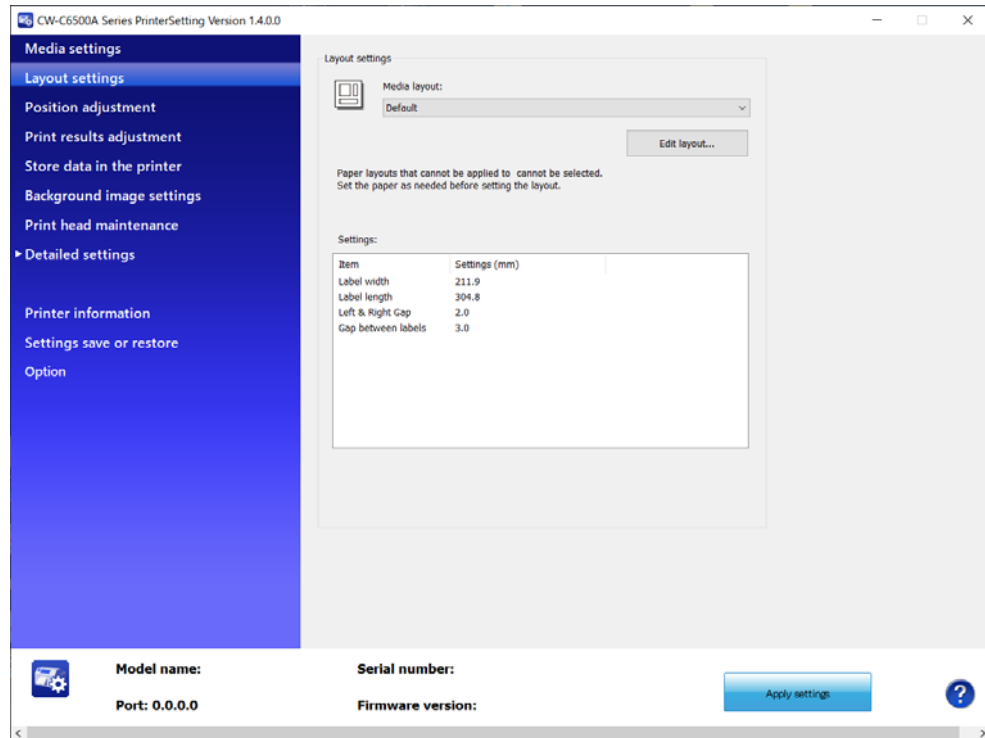

Item		Description
Layout settings	Media layout	Allows you to make paper layout settings.
	Edit layout...	Allows you to create a user-defined layout settings. The Layout settings window appears when you click this.

## Layout settings

Item	Description
Media layout name	Allows you to set a name for a new paper layout settings. Enter a name to set.
Defined media layout	If one or more sets of user-defined paper layout settings already exist, they are listed here.
Media form	Allows you to select a media form.
Layout Information	Allows you to specify a width and length of a label, a Left & Right Gap, and a gap between labels. Available setting items in [Layout Information] varies by media form. Before setting [Layout Information], select the media form.



When label length is long, length of printed image may be shorter than the specified length depending on paper used. It causes an extra margin on the bottom of a label (bottom means rear end in the paper feed direction). If you want to reduce the margin, try the following method.

Step 1: Examine print results on labels.

Step 2: Add the length of the extra margin to the label length in Layout settings.

## Position adjustment

Allows you to adjust print start position and cut position.

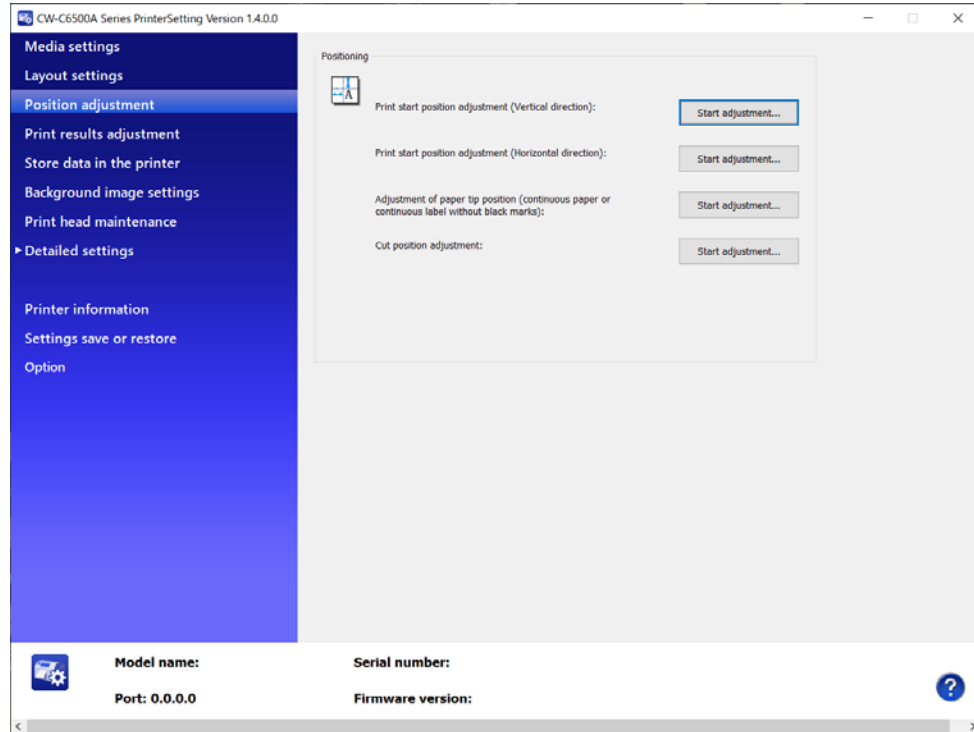

Item		Description
Positioning	Print start position adjustment (Vertical direction)	Allows you to adjust the print start position in the vertical direction. Adjustment procedure <a href="#">"Start adjustment" on page 194</a>
	Print start position adjustment (Horizontal direction)	Allows you to adjust the print start position in the horizontal direction. Adjustment procedure <a href="#">"Start adjustment" on page 194</a>
	Adjustment of paper top position (continuous paper or continuous label without black marks)	Allows you to adjust the print start position from the leading edge of continuous paper or continuous labels without black marks. Adjustment procedure <a href="#">"Start adjustment" on page 194</a>
	Peel position adjustment (Manual) (Peeler model only)	Allows you to adjust the manual label peeling position. Adjustment procedure <a href="#">"Start adjustment" on page 194</a>
	Peel position adjustment (Auto) (Peeler model only)	Allows you to adjust the auto label peeling position. Adjustment procedure <a href="#">"Start adjustment" on page 194</a>
	Cut position adjustment (Auto cutter model only)	Allows you to adjust the cut position. Adjustment procedure <a href="#">"Start adjustment" on page 194</a>

## Start adjustment

- 1 The window shown below appears when you click [Start adjustment].  
(The window is of Print start position adjustment (Vertical direction).)

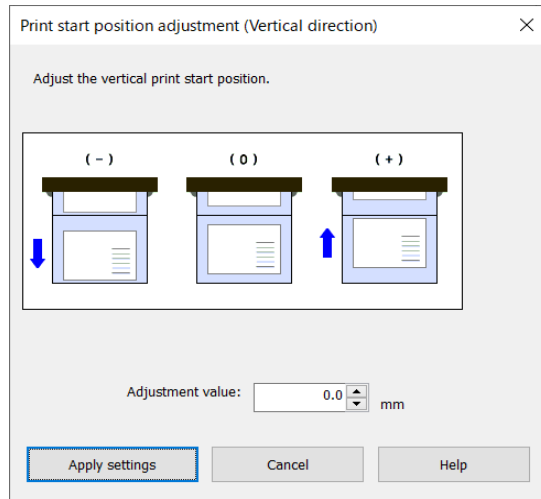

- 2 Enter a value in the [Adjustment value] box, and then click [Apply settings].
- 3 A confirmation window appears. If you click [Yes], the change is applied.

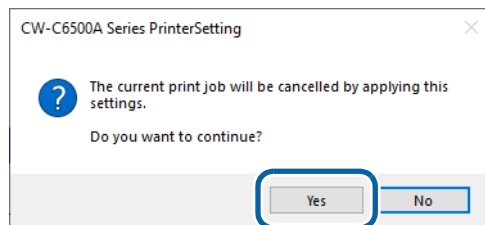

- 4 The result is displayed. Click [OK].
- 5 Print on some labels to check the position is corrected as intended.

## Print results adjustment

Allows you to adjust colors and barcode.



This is not displayed if you start PrinterSetting from the printer driver.

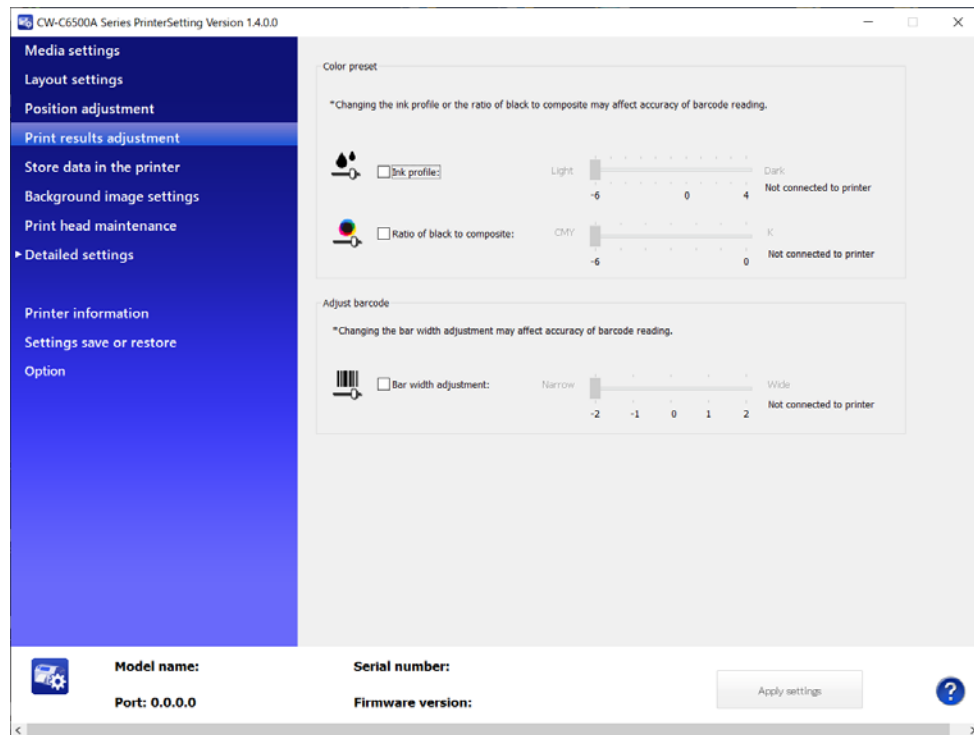

Item		Description
Color preset	Ink profile	Allows you to adjust print density. To ensure print quality, adjust this when you change paper.
	Ratio of black to composite	Allows you to set the ratio of black to composite.
Adjust barcode	Bar width adjustment	When using a built-in barcode font, use this to adjust the bar width.



If you increase the ratio of black ink, be careful not to touch the label surface immediately after printing because ink can adhere to your fingers.

## Store data in the printer

Allows you to register images, templates, fonts, character code tables, and spot colors to the printer.

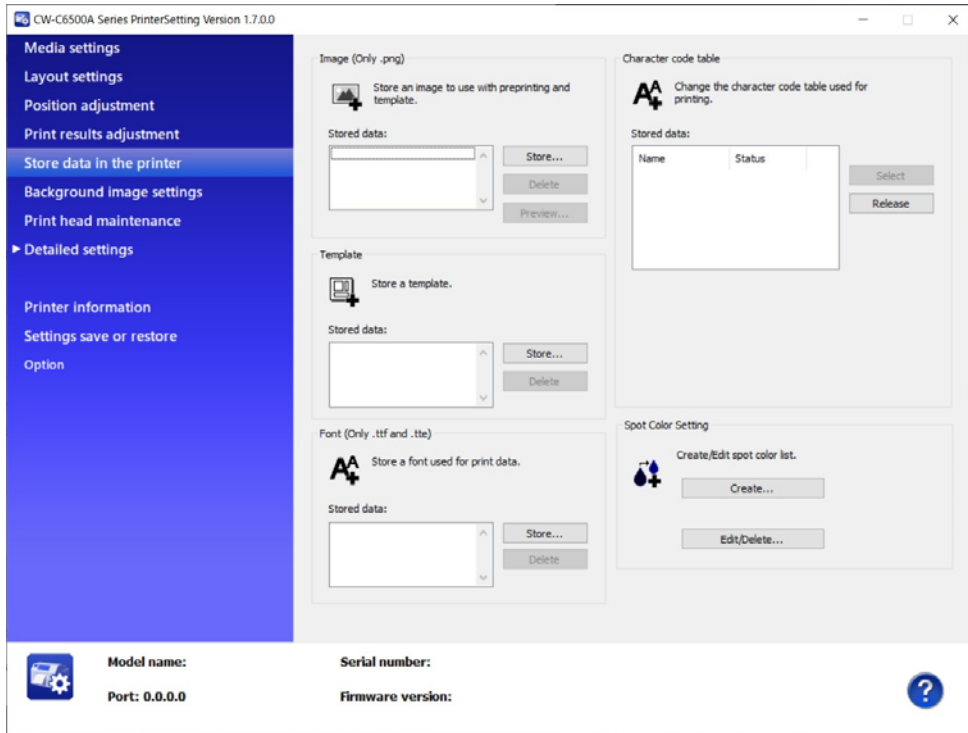

Item	Description
Image (Only .png)	You can register images to be used for preprinting or templates.
Template	Allows you to register templates.
Font (Only .ttf and .tte)	Allows you to register fonts to be used in print data.
Character code table	Allows you to register character code tables to use when printing. Character encoding settings are displayed at the bottom of the [Stored data] list.
Spot Color Setting	Allows you to create spot color setting files.

## Registering Images

You can register frequently used color images to the printer.

### Creating a background image

- 1 Prepare an image file in PNG format that has resolution appropriate for printing by the printer.

See "Product Specifications" on page 358.

- 2 Replace an image according to the media size.

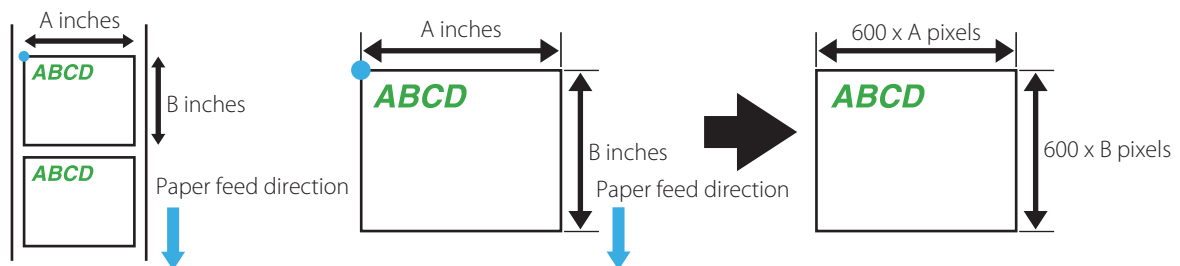

Make sure to match the resolution of the image with print resolution.

- 3 Save the image file in PNG format.

## Registering Images

Click [Store...] in the [Image (Only .png)] field to display a screen to select an image.

Specify a png image file to be stored, and then click [Set].

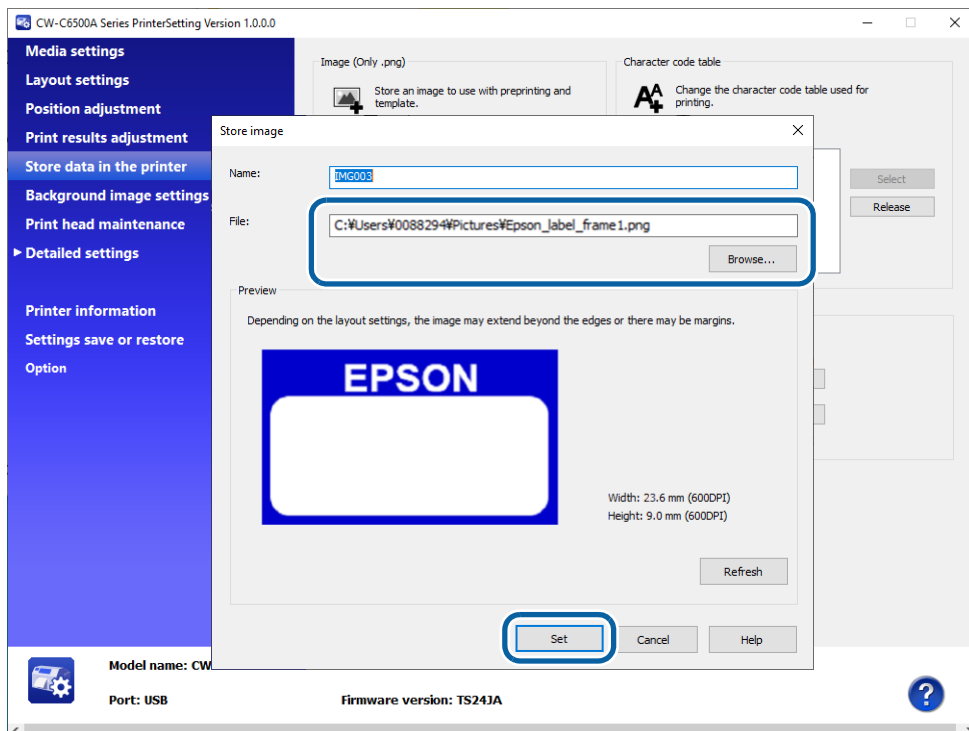

The image file is sent to the printer and stored as a background image.

## Registering Templates

The term “template” indicates a standard size label format used by an application that directly controls ESC/Label commands. Registering a template that can be used for your various labels allows your application to generate only data of variable information and print the data combining it with the registered template.

To create a template and to specify the template to print, use the ESC/Label commands.

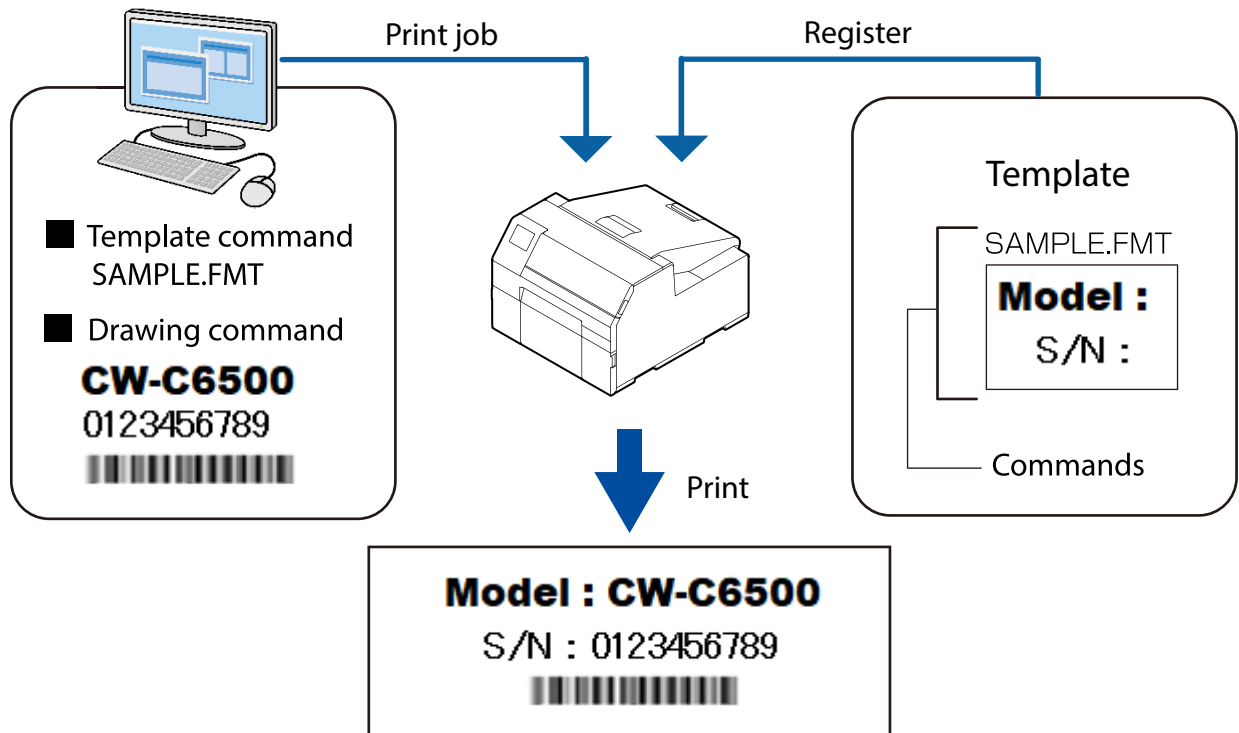

## Creating Templates

Using the ESC/Label commands, write label format to be registered on a text or binary file. In the label format description, write the file name of the template file. For more details about the commands, refer to the “Save label format” section in “ESC/Label Command Reference Guide”. There is no prescribed file extension for the text or binary file.

## Registering Templates

Click [Store...] in the [Template] field to display a screen to select a template file.

Select the text or binary file that you created as the template file, then click [Set].

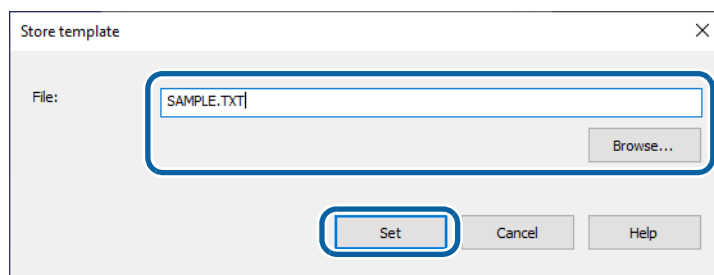

The template file is stored in the printer.

## Registering Fonts

Click [Store...] in the [Font (Only .ttf and .tte)] field to display a screen to select a font.

Specify the font file (.TTF format) to be stored, and then click [Set].

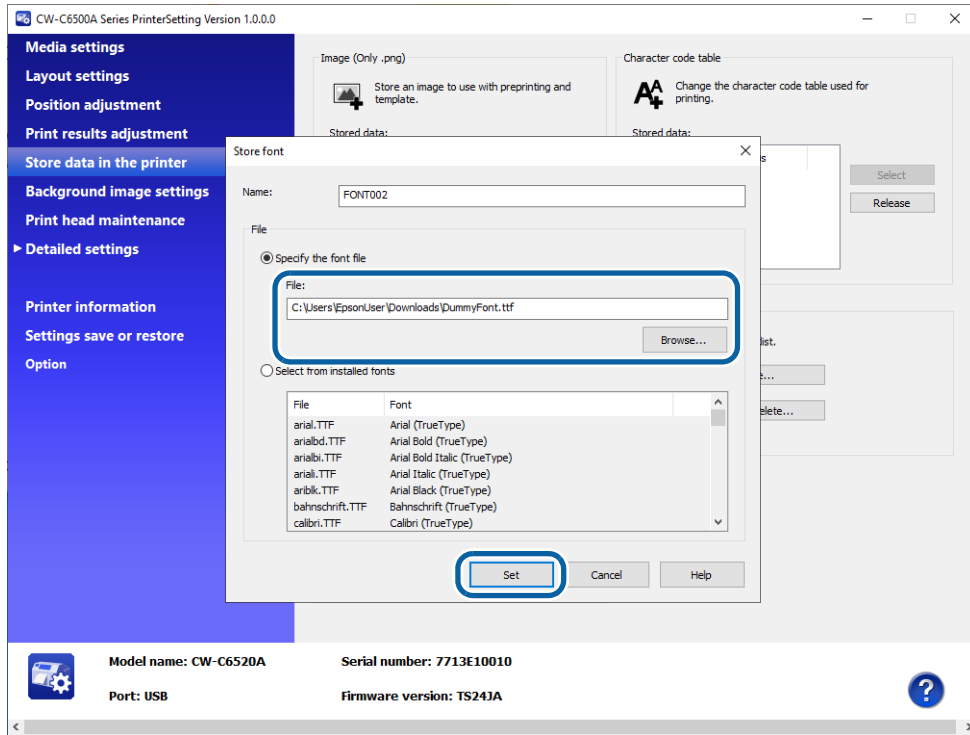

The font file is sent to the printer and stored as a built-in font.

## Setting Character code table

To print characters under the direct control of ESC/Label commands, you need to set character code table that corresponds to the character code you use.

Character code	language	Character code table
BIG5	Traditional Chinese	BIG52K7.CNV
EUC-CN	Simplified Chinese	EUCCN199.CNV
EUC-JP	Japanese	EUCJP2K7.CNV
KS X 1001(KS-C 5601-1987)	Korean	EUCKR2K6.CNV
GB18030	Simplified Chinese	GB18030.CNV
Shift-JIS	Japanese	SJIS2K3.CNV

Select a character code in the [Stored data:] box in the [Character code table] field, and then click [Select].



If you have replaced from a ZPL II compatible monochrome printer, a character code that CW-C6000/C6500 Series do not support may be specified and the specified character code table may not be applied. In such case, select [Advanced settings] from the [Detailed settings] menus, then select [Character encoding used] in the [Replace settings from printer using ZPL II commands] window. For details, see "[Settings for Replacing from ZPL II Compatible Monochrome Printer](#)" on page 216.

## Background image settings

Allows you to configure a background image.



- Use this function when using the following software.
  - Windows driver from Zebra Technologies Corporation
  - A commercially available label printing application that supports this printer
  - An application that directly controls ZPL II or ESC/Label commands
- This is not displayed if you start PrinterSetting from the printer driver.

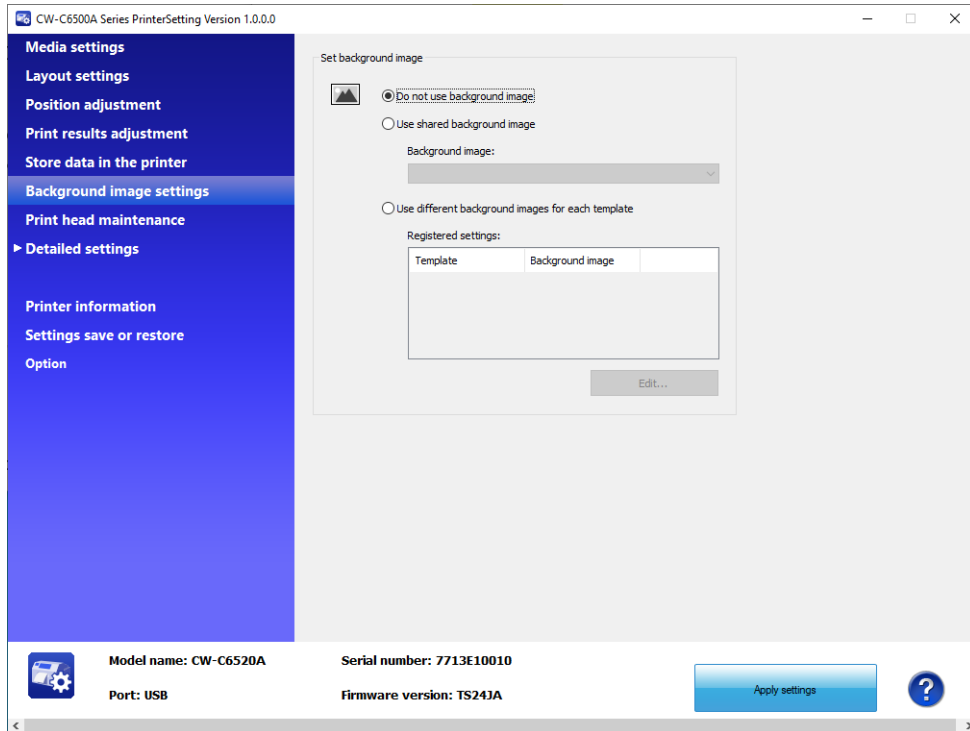

Item		Description
Set background image	Do not use background image	Select this when you do not want to print a background image.
	Use shared background image	The specified image is printed as a background image in normal printing mode. If you print using a template, the image is not printed.
	Use different background images for each template	If you print using a template, the image specified for the selected template is printed. If you do not use a template, the image is not printed.

### Printing the background image

The background image is printed with the following software.

- Windows driver from Zebra Technologies Corporation
- A commercially available label printing application that supports this printer
- An application that directly controls ZPL II or ESC/Label commands



The Epson printer driver does not support printing a background image.

## Linking the Image and the Template

CW-C6000/C6500 Series allows you to link an image to a template so that the image is printed being overlaid on the template automatically when the template is specified by an application.

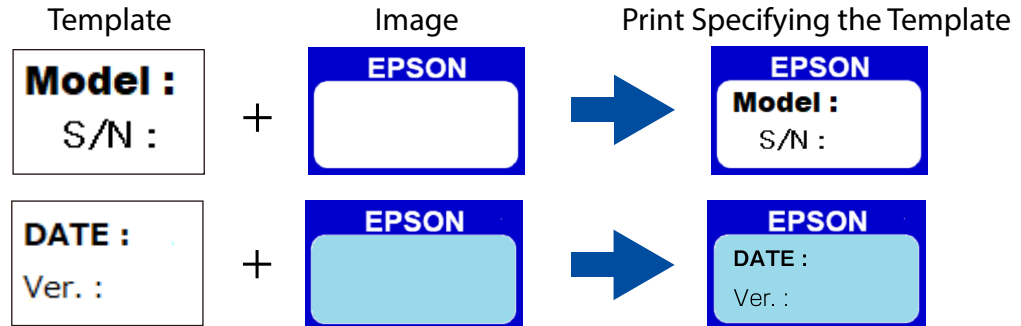

First store the image and the template data in the printer, and then make the link setting.

Store the image data: ["Registering Images" on page 197](#)

Store the template data: ["Registering Templates" on page 198](#)

When you have finished storing the data, make the link setting.

In the [Set background image] field, select [Use different background images for each template], and then click [Edit...].

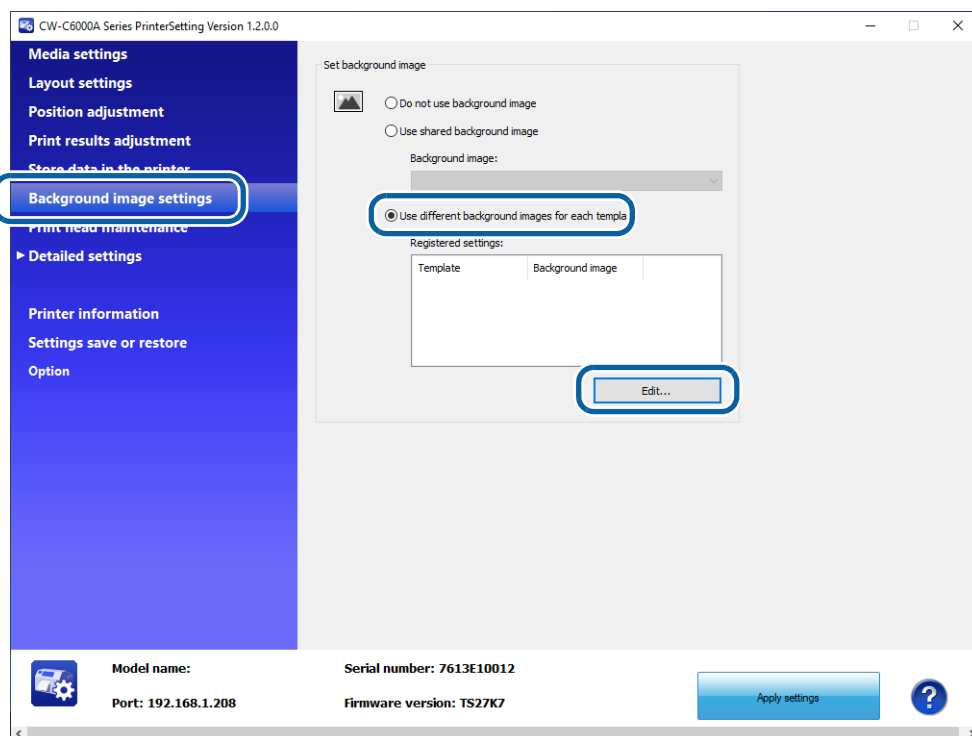



## Print head maintenance

Allows you to run a print head cleaning or nozzle check, and make settings for periodic cleaning.

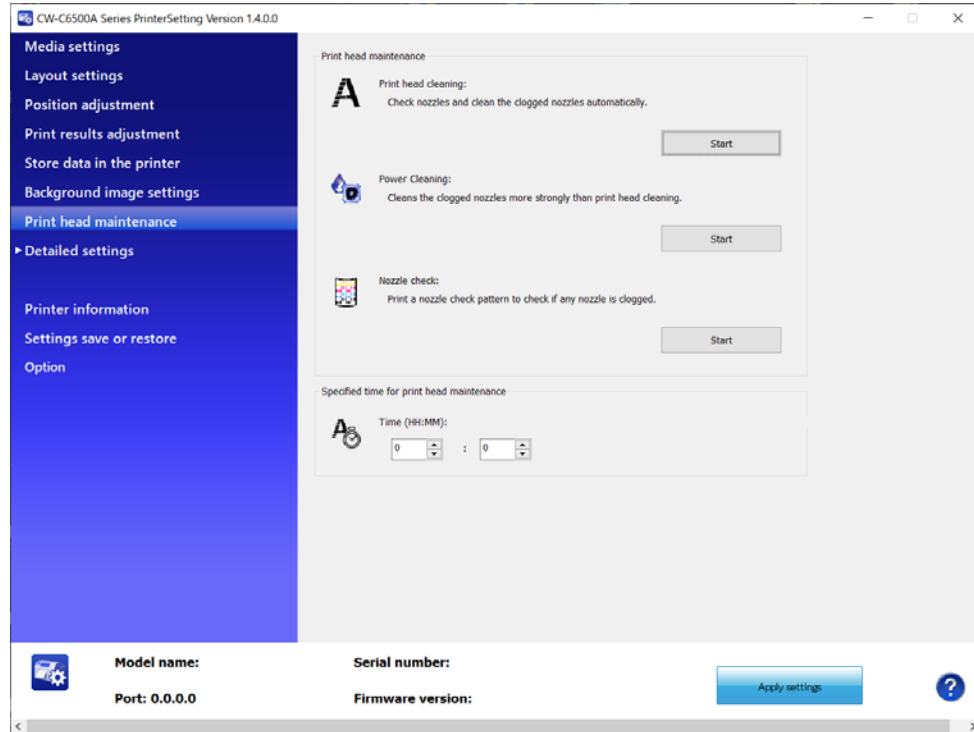



Item		Description
Print head maintenance	Print head cleaning	Runs a nozzle check and clears nozzle clogging. Click [Start] to run the cleaning.
	Power Cleaning	Clears nozzle clogging by running a cleaning that is more powerful than [Print head cleaning]. Click [Start] to run the cleaning.
	Nozzle check	The nozzle check patterns are printed to allow you to check print nozzles for clogging. Click [Start] to print the nozzle check pattern.
Specified time for print head maintenance		Allows you to set a time for running the cleaning. Specify the time in the [Time (HH:MM)] entry box. For details, see " <a href="#">Periodic Auto Cleaning</a> " on page 31.

## Printer settings

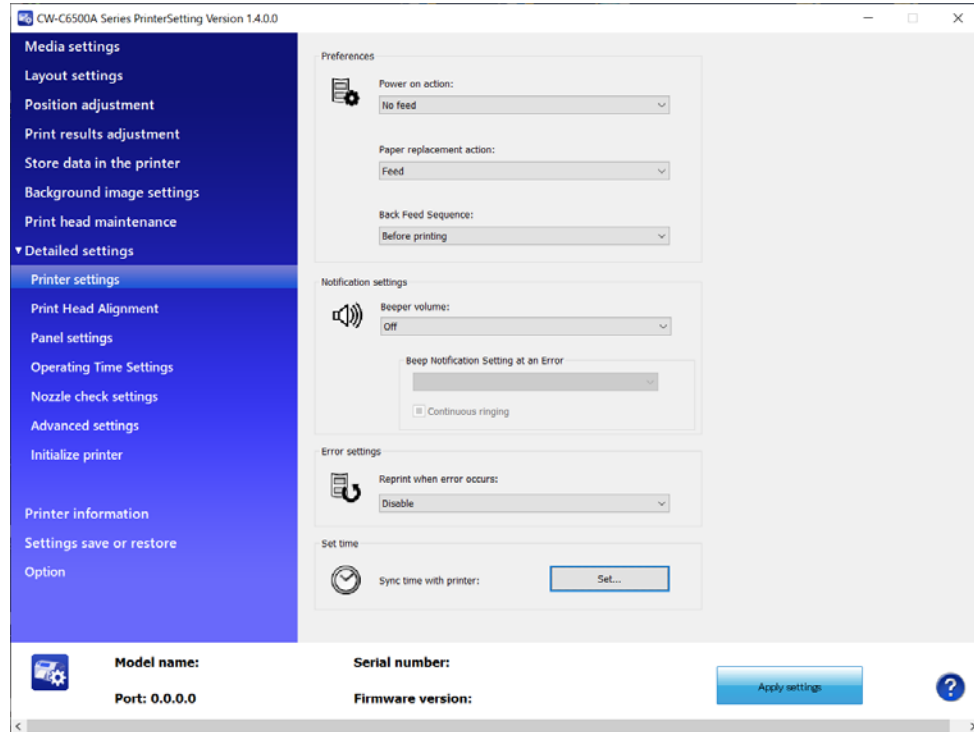
Allows you to configure the printer settings.



Item		Description
Preferences	Power on action	Select a printer action when the printer is powered on.
	Paper replacement action	Select a printer action when paper is replaced.
	Back Feed Sequence	Select the back feed timing.
Notification settings	Beeper volume	Set the volume of the buzzer.
	Beeper Notification Setting at an Error	Set whether to sound the buzzer when an error occurs. This setting is available when the [Beeper volume] setting is not [Off].
	Continuous ringing	Select the check box to let the buzzer sound continuously when an error occurs. To stop the beep, press the  (home) button or the  (back) button on the operation panel.
Error settings		Set whether or not to reprint when an error occurs.
Set time		Set the date and time settings of the printer.

## Print Head Alignment

Allows you to adjust the print head.

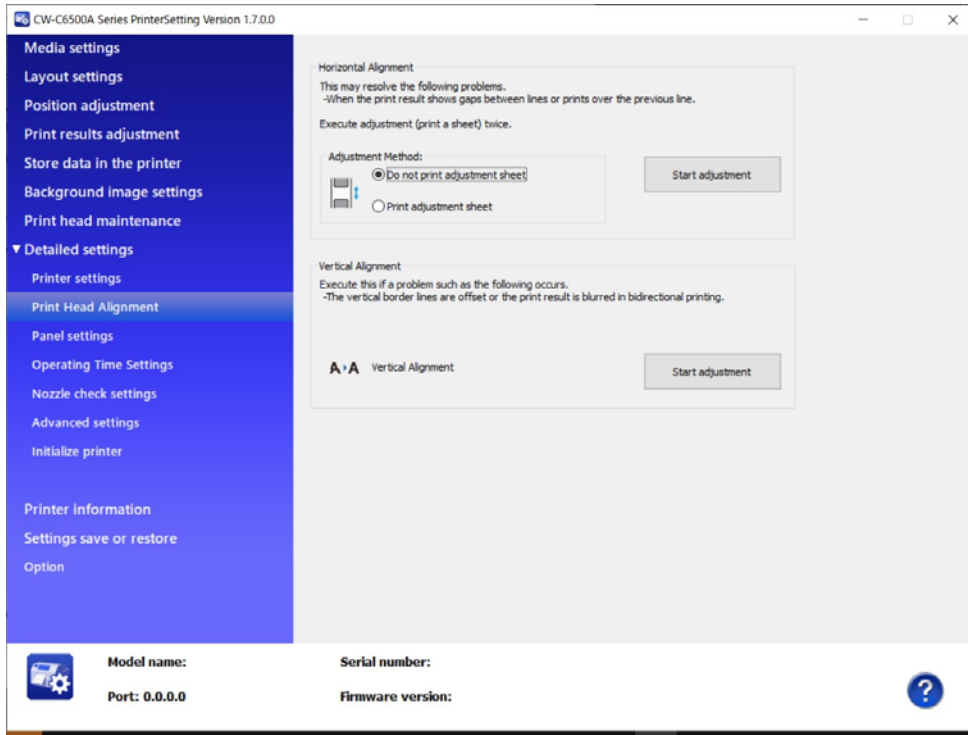

Item	Description
Horizontal Alignment	Carry out this adjustment when white or black banding/streaks appear on printouts. Adjustment procedure <a href="#">"Horizontal Alignment" on page 207</a>
Vertical Alignment	Carry out this adjustment when printed lines are skewed or misaligned, or printed text looks blurred. Adjustment procedure <a href="#">"Vertical Alignment" on page 209</a>

## Horizontal Alignment

This allows you to print the adjustment sheet for horizontal alignment when white or black banding/streaks appear on printouts.

Adjustment method	Description
Do not print adjustment sheet	Select this method if you do not have die-cut label, continuous paper, or full-page label paper with a length of 66.7 mm (2.63 inches) or longer. Prepare print data that you can easily check banding or streaks on printouts, and then configure the settings by printing and adjusting repeatedly.
Print adjustment sheet	Select this method to print a preset patterns for adjustment on die-cut label, continuous paper, or full-page label paper with a length of 66.7 mm (2.63 inches) or longer, and carry out the adjustment using the printed patterns.



- When improving horizontal alignment, keep the printer settings unchanged from the settings you usually use.
- For the peeler model, make sure to load paper correctly so that it matches the setting in [Settings for Paper Handling After Print].
  - For [Auto apply] or [Manual apply]: pass the paper through the peeler.
  - For [Rewind]: do not pass the paper through the peeler.

### Do not print adjustment sheet

- 1 Prepare print data that you can easily check banding or streaks on printouts.
- 2 Print the prepared data from the printer.
- 3 Select [Do not print adjustment sheet] from [Adjustment Method], and then click [Start adjustment].
- 4 The first Horizontal Alignment window appears. Look at the print results and then select a setting value.

After selecting a setting value, click [OK].

If there are gaps (white banding), make the adjustment in the + direction.

If there is overlapping in the print results (black banding), make the adjustment in the – direction.

The adjustment increment is 0.0105 mm (1/2400 inch).

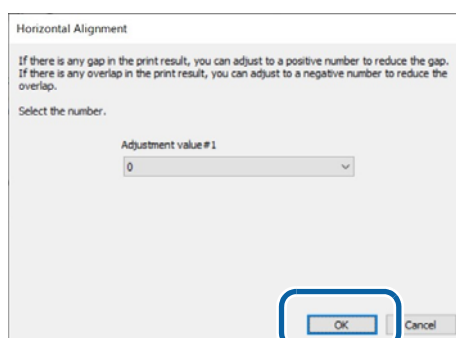

- 5 An adjustment start confirmation window appears. Click [Yes].**  
The second Horizontal Alignment window appears.
- 6 In the same way as step 4, look at the print results and then select a setting value.**
- 7 When adjustment is complete, a complete window appears. Click [OK].**
- 8 Print the data prepared in step 1 again.**
- 9 Check the print results.**  
If gaps are no longer conspicuous, the setting is complete.  
To make further adjustment, repeat steps 3 to 9.

### Print adjustment sheet

- 1 Load die-cut label, continuous paper, or full-page label paper with a length of 66.7 mm (2.63 inches) or more into the printer.**
- 2 Select [Print adjustment sheet] from [Adjustment Method], and then click [Start adjustment].**
- 3 A confirmation window to print the adjustment sheet appears. Check that paper is loaded in the printer and then click [OK].**  
The adjustment sheet is printed and the first Horizontal Alignment window appears.
- 4 Check the sheet and then select the number for the pattern with the least gaps or overlapping in each of #1 and #2 groups, and then click [OK].**  
Adjustment sheet print example (for this sheet, select "0" for both #1 and #2 groups.)

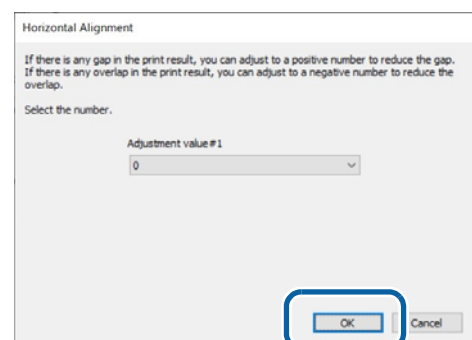
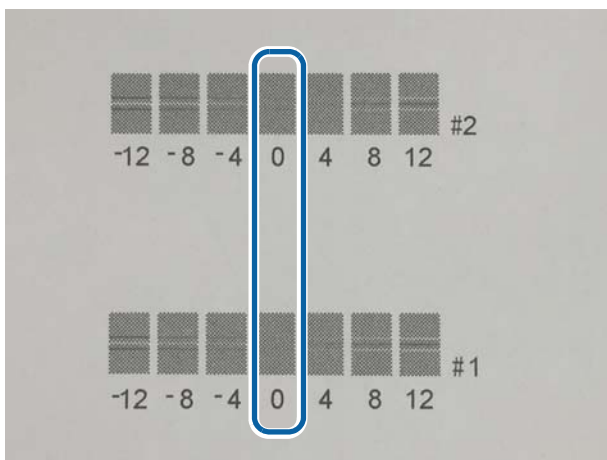

- 5 A confirmation window to print the adjustment sheet appears again. Click [Yes].**  
The adjustment sheet is printed and the second Horizontal Alignment window appears.

- 6** In the same way as step 4, look at the print results and then select a setting value.
- 7** An adjustment start confirmation window appears. Click [Yes].
- 8** When adjustment is complete, a complete window appears. Click [OK].

---

## Vertical Alignment

When printed vertical or horizontal lines look skewed or misaligned, or when printed text looks blurred, print the adjustment sheet.



Whether or not to perform bi-directional printing can be set in [Print Quality] - [Advanced] - [Bidirectional Printing] on the printer driver.

- 1** Load die-cut label, continuous paper, or full-page label paper with a length of 66.7 mm (2.63 inches) or more into the printer.
- 2** Click [Start adjustment].  
A confirmation window to print the sheet for Vertical Alignment appears.
- 3** Check that paper is loaded in the printer and then click [OK].  
The adjustment sheet is printed and the Vertical Alignment window appears.

**4** Check the sheet and then select the number for the pattern with the least gaps or overlapping in each of #1, #2, and #3 groups, and then click [OK].

Adjustment sheet print example (for this sheet, select "2" for #1 group, select "0" for #2 group, and select "2" for #3 group.)

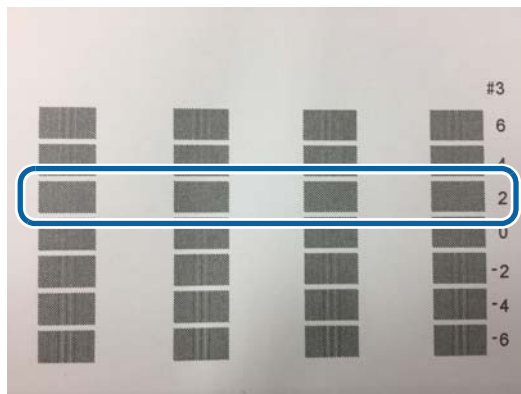
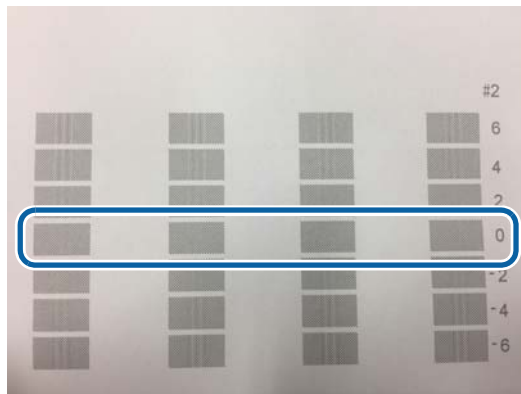
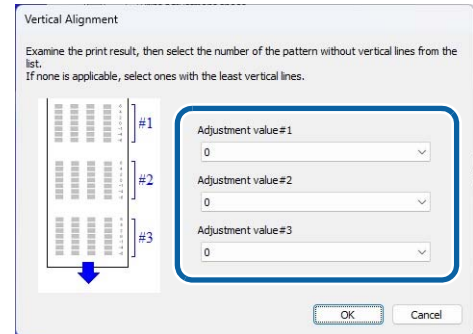
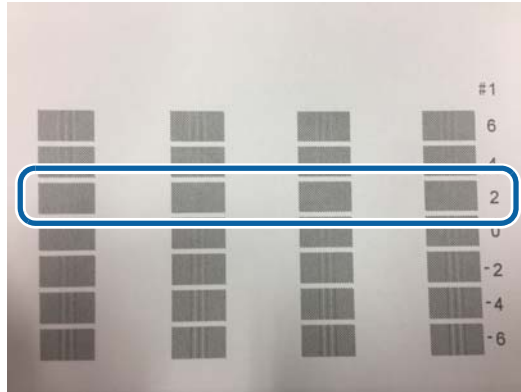

**5** An adjustment start confirmation window appears. Click [Yes].

**6** When adjustment is complete, a complete window appears. Click [OK].

## Panel settings

Allows you to configure the panel settings.

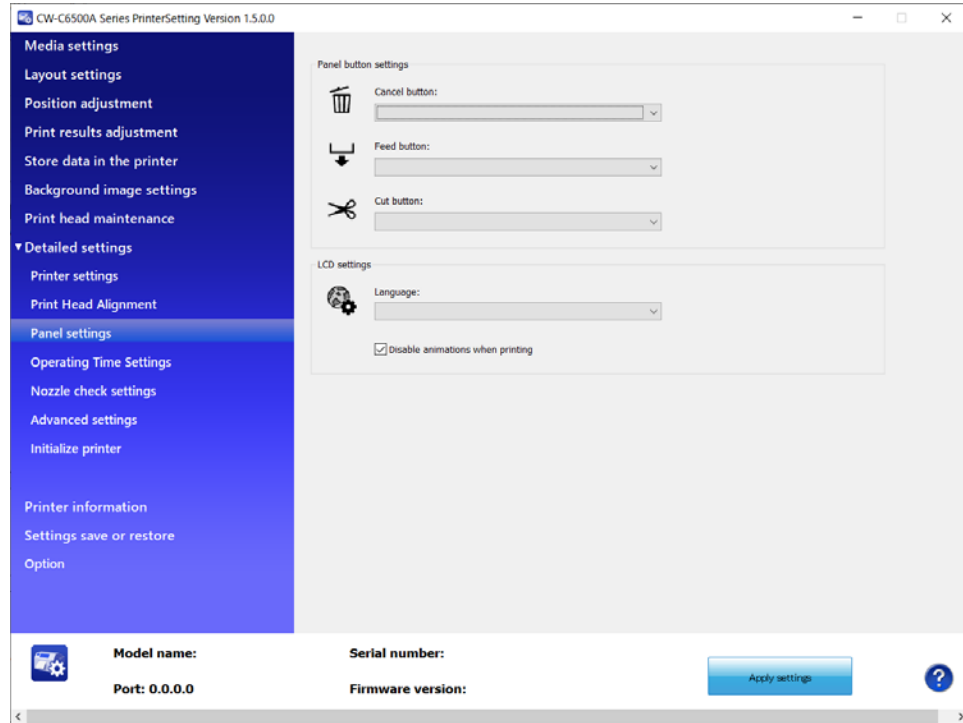

Item		Description
Panel button settings	Cancel button	Select whether to enable or disable the cancel button.
	Feed button (Auto cutter model only)	Select whether to enable or disable the feed button.
	Cut button (Auto cutter model only)	Select whether to enable or disable the cut button.
	Peeler reset button (Peeler model only)	Select whether to enable or disable the peeler reset button.
LCD settings	Language	Select the language to display.
	Disable animations when printing	Select whether to enable or disable animations during printing. See <a href="#">"Disable animations when printing"</a> on page 212

## Disable animations when printing

Animations when printing is a function for confirming that printing is being performed by checking the white bar moving from left to right that is displayed on the operation panel of the printer.

As the default setting is for the check box of [Disable animations when printing] to not be selected, animations are displayed when printing on the operation panel of the printer.

Select the check box for [Disable animations when printing] to disable animations displayed on the operation panel of the printer during printing and possibly reduce the printing time.

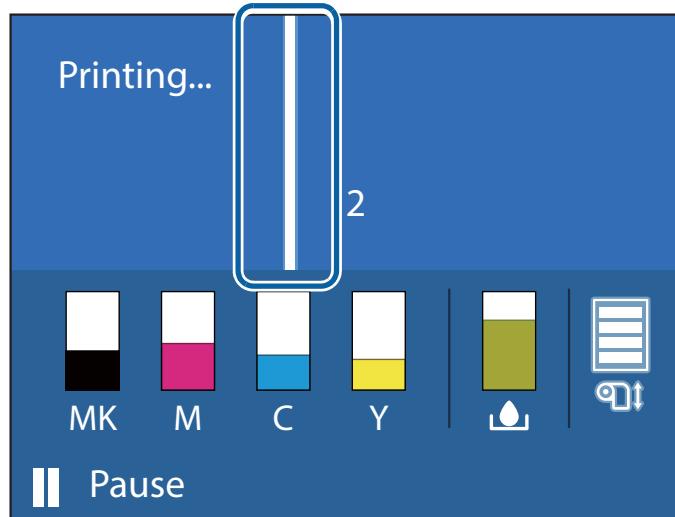

## Operating Time Settings

Allows you to change the power saving settings.

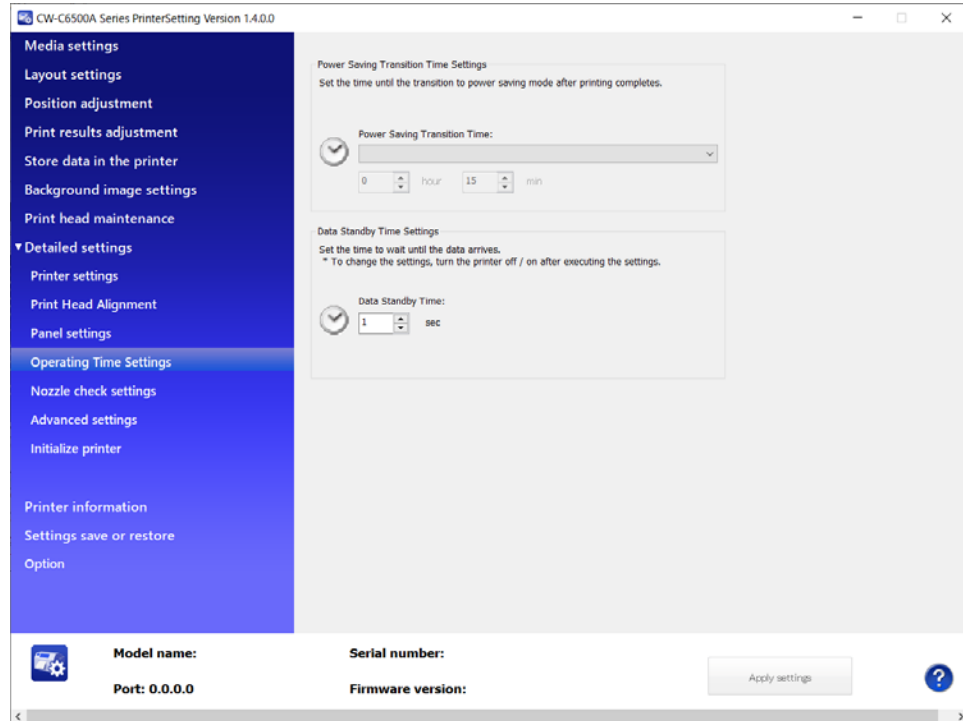

Item	Description
Power Saving Transition Time Settings	Set a time period to let the printer enter into the power saving mode after completion of printing.
Waiting time of back feed after label peeling (Peeler model only)	Set a time period before the printer starts feeding paper backward after peeling labels.
Data Standby Time Settings	<p>Set a standby time for waiting until subsequent data after completion of printing.</p> <p>If the subsequent data does not arrive within this standby time, the head is returned to the home position to protect the head.</p> <p>If the head is returned to the home position, it will take slightly more time for the next print job to start.</p> <p>Set the data waiting time within the range of 1 to 15 seconds.</p>

## Nozzle check settings

Allows you to change the nozzle check settings.

For more details about the nozzle check, see ["Nozzle Verification Technology Settings" on page 28](#), and for more details about the dot substitution function, see ["Dot Substitution \(Supplemental Printing\) Function" on page 30](#).

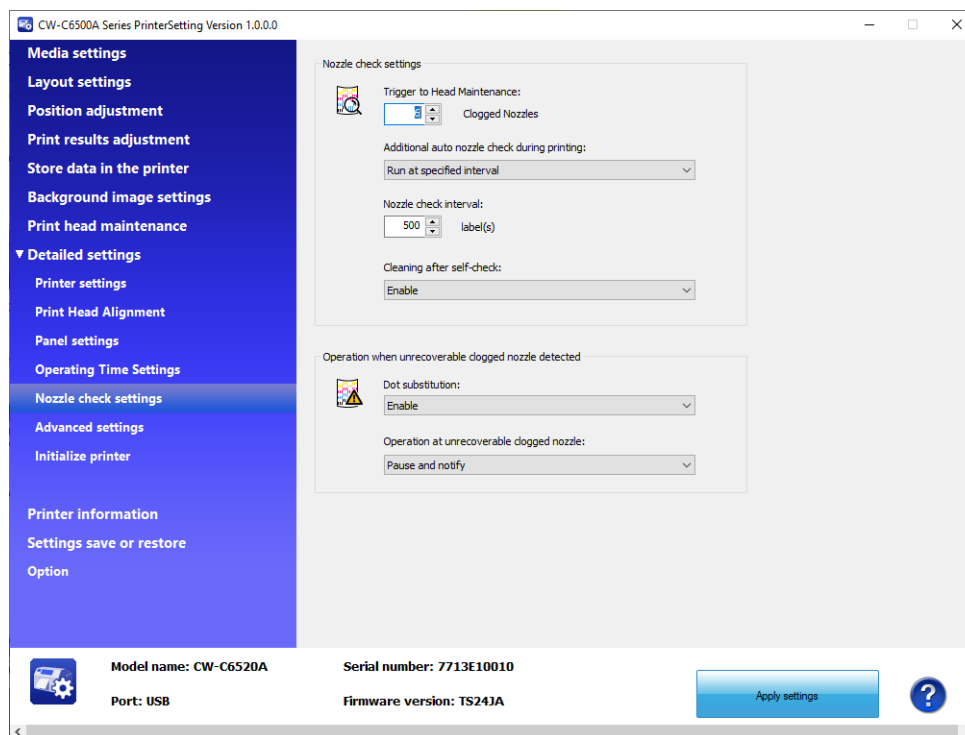

Item		Description
Nozzle check settings	Trigger to Head Maintenance	Specify the maximum number of clogged nozzles that is allowed to continue printing.
	Additional auto nozzle check during printing	Select whether to run an auto nozzle check during printing.
	Nozzle check interval	When you have enabled [Additional auto nozzle check during printing], set an interval between checks.
	Cleaning after self-check	Select whether to run an auto cleaning after self-check.
Operation when unrecoverable clogged nozzle detected	Dot substitution	Select whether to enable or disable the Dot substitution function. See <a href="#">"Dot Substitution (Supplemental Printing) Function" on page 30</a> .
	Operation at unrecoverable clogged nozzle	Select an operation when unrecoverable clogged nozzles are detected.

## Advanced settings

Allows you to configure the advanced printer settings.

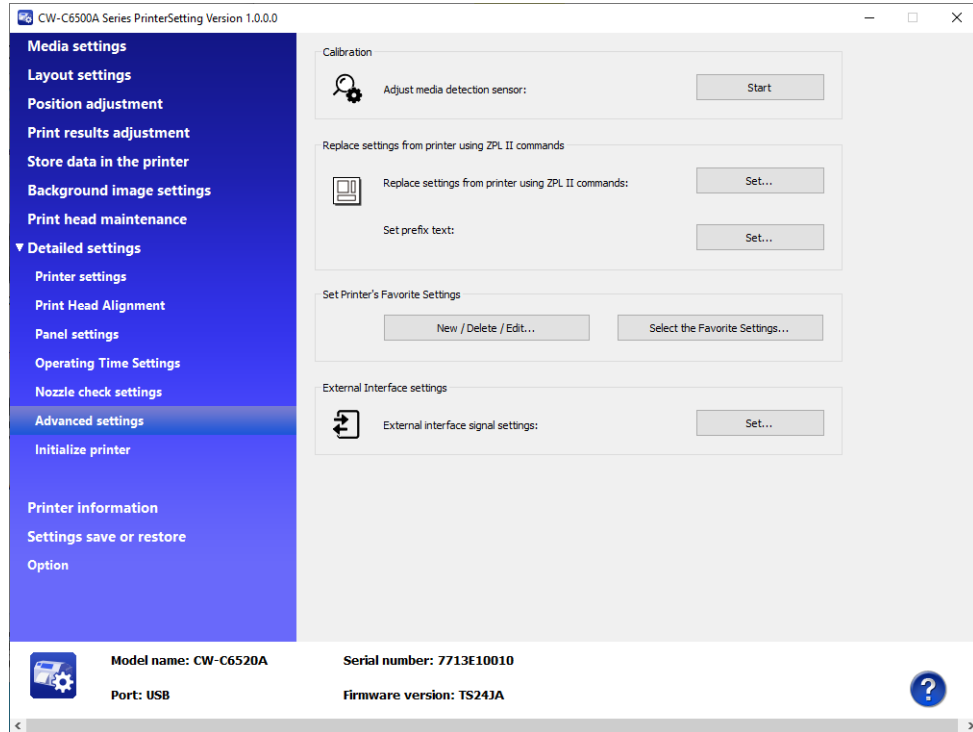

Item		Description
Calibration		Allows you to carry out calibration of sensors.
Replace settings from printer using ZPL II commands	Replace settings from printer using ZPL II commands	Allows you to make and apply settings for replacing from a ZPL II compatible monochrome printer. The "Replace settings from printer using ZPL II commands" window appears when you click [Set...]. See " <a href="#">Settings for Replacing from ZPL II Compatible Monochrome Printer</a> " on page 216.
	Set prefix text	Allows you to set prefix text.
Set Printer's Favorite Settings		Allows you to register favorite settings to the printer, or edit the settings. See " <a href="#">Registering Favorite Settings</a> " on page 221.
External Interface settings		Allows you to set signals for external (extended) interface.

## Settings for Replacing from ZPL II Compatible Monochrome Printer

Click [Set...] for [Replace settings from printer using ZPL II commands] to open the setting window.



When adjusting, make the adjustment checking actual printouts.

### Resolution Settings

Select the resolution in the [Resolution of the printer in use] pull-down menus.

If the same resolution is not found in the menus, select one of the closest resolution. For example, if the resolution of the ZPL II compatible monochrome printer you were using is 203 dpi, select 200 dpi.

### Monochrome Print Mode Setting

If you use the printer just as a replacement of your previous ZPL II compatible monochrome printer and do not perform color printing, select the check box.

### Vertical/Horizontal Positioning

You can adjust the print position of objects such as text, image, or graphic.

If you have set the same resolution as the resolution of the ZPL II compatible monochrome printer in the [Resolution of the printer in use] setting, set “0” (zero) to both the [Vertical positioning] and [Horizontal positioning].

If the resolution of the ZPL II compatible monochrome printer you were using is 203 dpi, and you have set the [Resolution of the printer in use] setting to [200 dpi], set “-1.5” to both the [Vertical positioning] and [Horizontal positioning].

## Font Replacement

Click [Settings] beside [Font replacement].

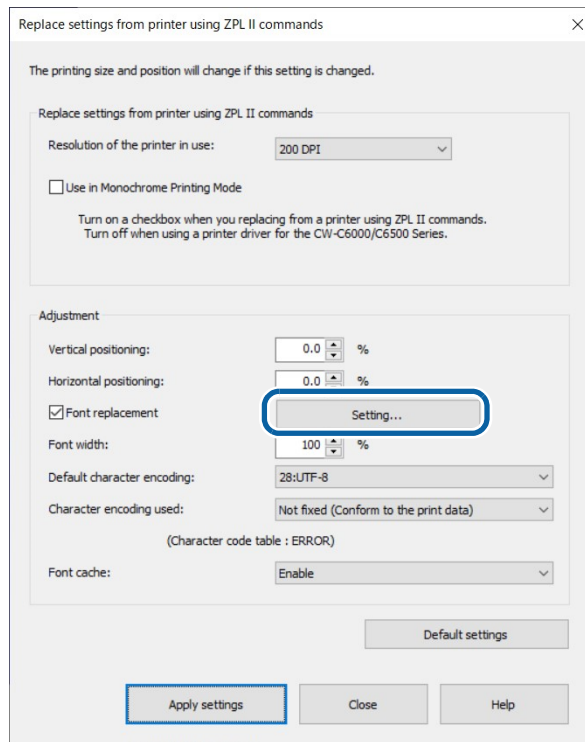

When the setting window is displayed, select the font ID from the list box.

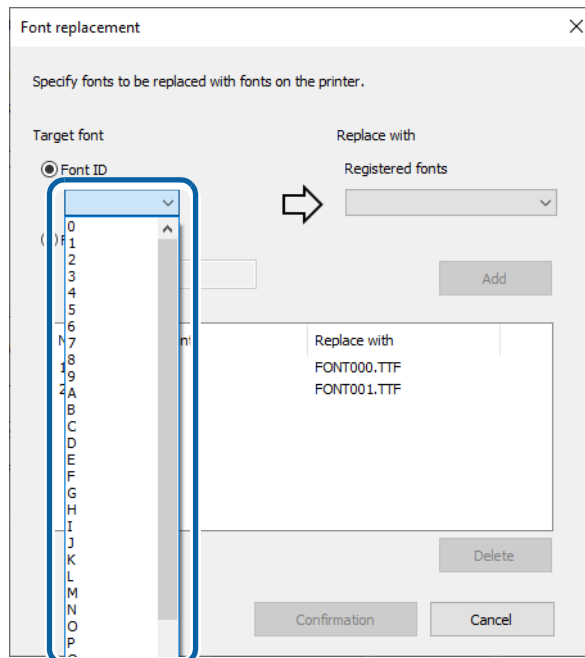

With the font ID specified, select a registered font to be associated to the font ID.

Font replacement

Specify fonts to be replaced with fonts on the printer.

Target font

Font ID

0

Font name

Replace with

Registered fonts

FONT000.TTF

FONT000.TTF

FONT001.TTF

Add

No.	Target font	Replace with

Delete

Confirmation Cancel

Click [Add] to add the pair to the list in the window.

Click [Confirmation] to save the list and go back to the “Replace settings from printer using ZPL II commands” window.

Select the check box for [Font replacement] to apply the font replacement settings.

Font replacement

Specify fonts to be replaced with fonts on the printer.

Target font

Font ID

0

Font name

Replace with

Registered fonts

FONT000.TTF

Add

No.	Target font	Replace with
1	0	FONT000.TTF

Delete

Confirmation Cancel

## Font Width Setting

You can change the font width. At first, set to “100”.



If you want to change the height of font or space between lines, configure it on an application.

## Default character encoding Setting

Set the default settings for character encoding. The settings are referenced depending on the content of the print data.

## Character encoding used

Set the character encoding to be used in printing.

- Not fixed (Conform to the print data)  
Conforms to the print data. Depending on the content of the print data, the settings in the [Character code table] and [Default character encoding] are also referenced.
- Setting of [Default character encoding]  
Printing will be performed conforming to the setting of [Default character encoding].
- Setting of [Character code table]  
Printing will be performed conforming to the setting of [Character code table].

## Font Cache Function Settings

The printer accesses the font data on an SD card when replacing fonts.

Enabling the font cache function may shorten printing time because font data from the SD card can be cached in the RAM drive.



Enabling the font cache function uses up RAM drive space.

Replace settings from printer using ZPL II commands

The printing size and position will change if this setting is changed.

Replace settings from printer using ZPL II commands

Resolution of the printer in use: 200 DPI

Use in Monochrome Printing Mode

Turn on a checkbox when you replacing from a printer using ZPL II commands.  
Turn off when using a printer driver for the CW-C6000/C6500 Series.

Adjustment

Vertical positioning: -1.5 %

Horizontal positioning: -1.5 %

Font replacement Setting...

Font width: 100 %

Default character encoding: 28:UTF-8

Character encoding used: Not fixed (Conform to the print data)

(Character code table : ERROR)

Font cache: **Enable**

Default settings

Apply settings Close Help

### **Applying the Settings**

When you have finished making necessary settings, click [Apply settings].

All the settings are sent and set to the printer.

## Registering Favorite Settings

- 1 Click [New/Delete/Edit] in [Set Printer's Favorite Settings].
- 2 The "Edit Printer's Favorite Settings" window appears. Click [New...].

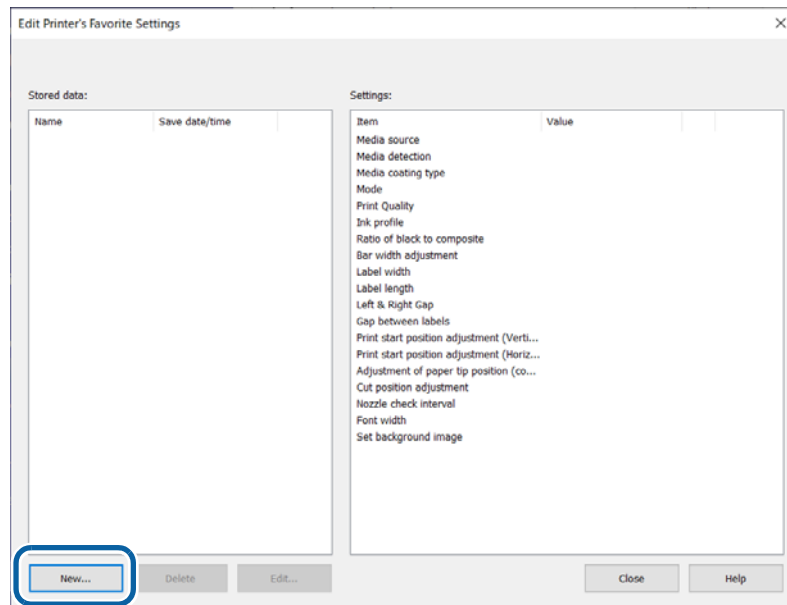

**3** The “Register Printer’s Favorite Settings” window appears. Enter a name for the settings in the [Favorite Settings Name] box, and make the settings in [Printer’s Favorite Settings]. When finished, click [Set].



- For the favorite settings name, you can use up to 15 ASCII (20h to 7Eh) characters excluding ^, ~, ;, comma, and period.
- Up to 100 sets of favorite settings can be registered.

When you want to reset your settings to the default settings, click [Default settings].

The screenshot shows the 'Register Printer's Favorite Settings' dialog box. At the top, the 'Favorite Settings Name' field is set to 'Media 000'. Below this is the 'Printer's Favorite Settings' section, which is divided into several columns of adjustable parameters. The 'Default settings' button at the bottom left is highlighted with a blue box. Other buttons at the bottom include 'Set', 'Close', and 'Help'.

**4** Click [Close] to return to the “Edit Printer’s Favorite Settings” window. The favorite settings you added are displayed in the [Stored data] box.

## Applying Favorite Settings

Follow the procedure below to apply the registered favorite settings to the printer.

- 1 Click [Select the Favorite Settings] in [Set Printer's Favorite Settings].
- 2 The "Select Printer's Favorite Settings" window appears. In the [Favorite Settings Name] box, select a set of favorite settings you want to apply to the printer, and then click [Apply settings].

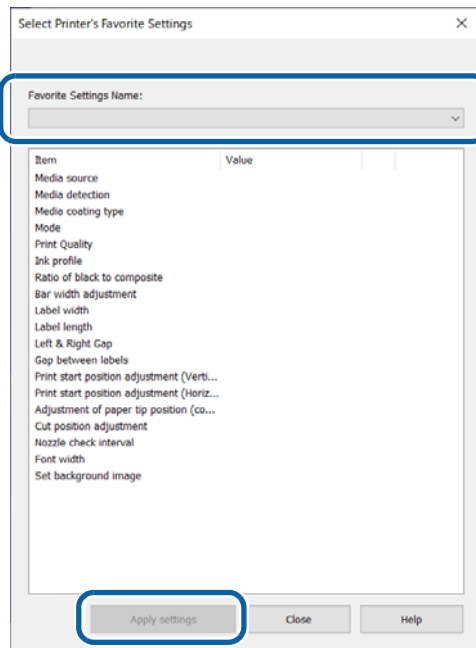

If printing multiple types of media on a single printer, registering print settings for each media is convenient and eliminates the need to enter print settings each time the media is changed.

## Initialize printer

Allows you to initialize the printer.



When the printer is initialized using the [Initialize] menu, all image files and setting files you have registered are deleted.

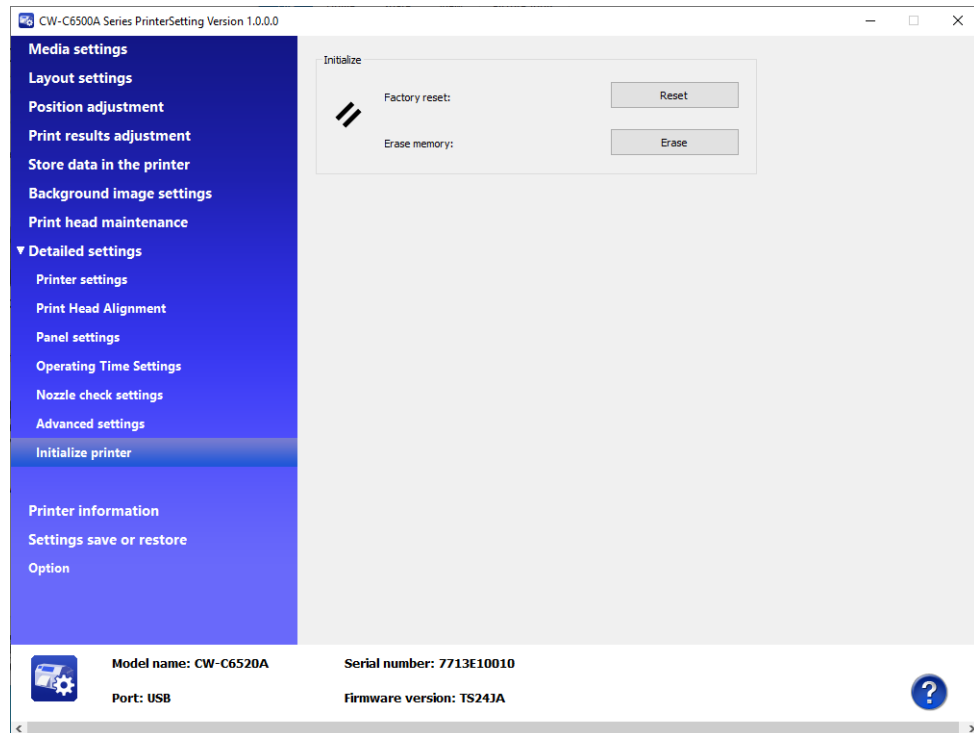

Item		Description
Initialize	Factory reset	Returns the printer settings to their defaults.
	Erase memory	Initializes the extended memory.

## Printer information

Displays information of the printer.

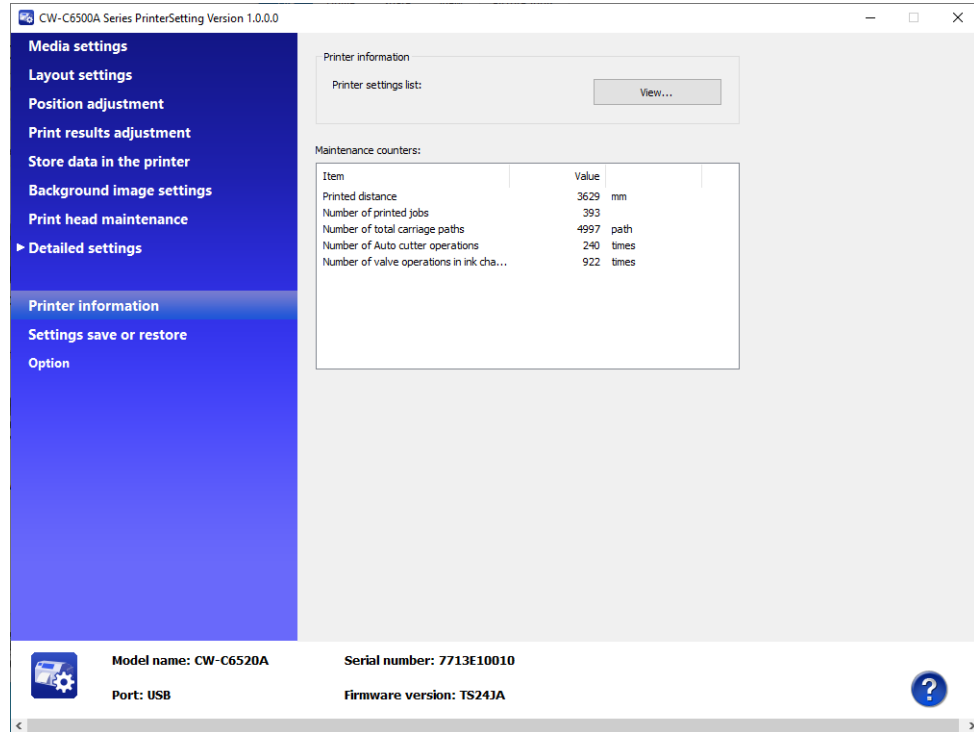

Item		Description
Printer information	Printer settings list	Click [View...] to see the current settings of the printer. See " <a href="#">Printer settings list</a> " on page 226.
Maintenance counters		Allows you to check the maintenance counters.

## Printer settings list

The “Printer settings list” window appears when you click [View...]. You can save the settings as a file by clicking [Output to file...].

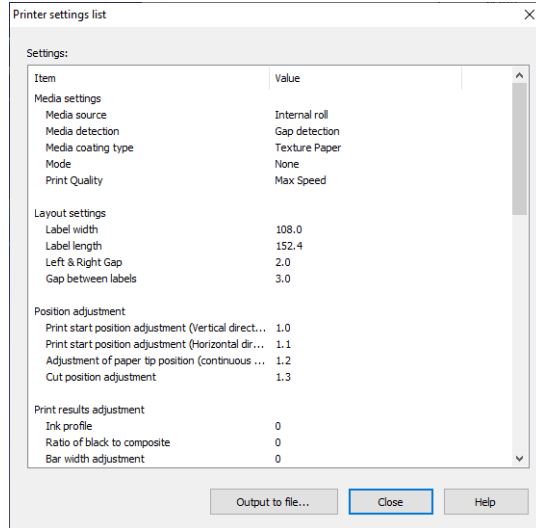

## Settings save and restore

Allows you to save the settings of the printer and restore the saved settings.

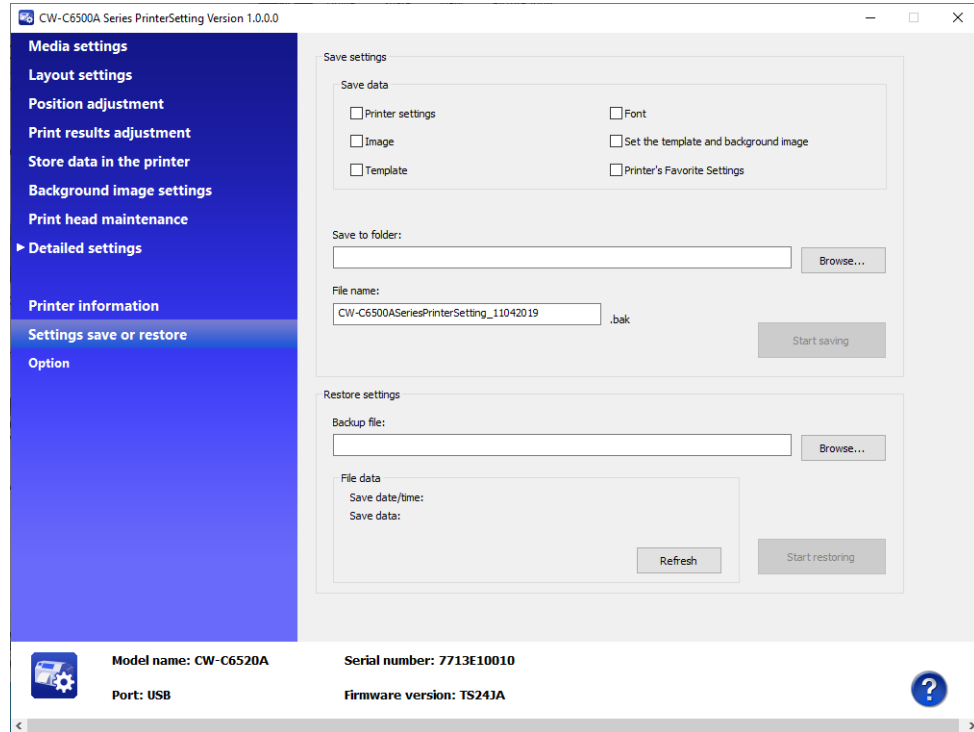

Item		Description
Save settings	Save data	Select setting items to save. Select the check box for the items.
	Save to folder	Specify a folder to save the file.
	File name	Enter a file name.
	Start saving	Click [Start saving] after selecting items to save, specifying a file name and a folder to save. The selected settings will be saved.
Restore settings	Backup file	Select a setting file you have saved.
	File data	Information of the selected file is displayed.
	Start restoring	Click [Start restoring] after selecting a file to restore. The settings of the selected file will be applied.



It may take time depending on the size of the file.

## Option

A unit of length used in PrinterSetting and start up setting can be changed.

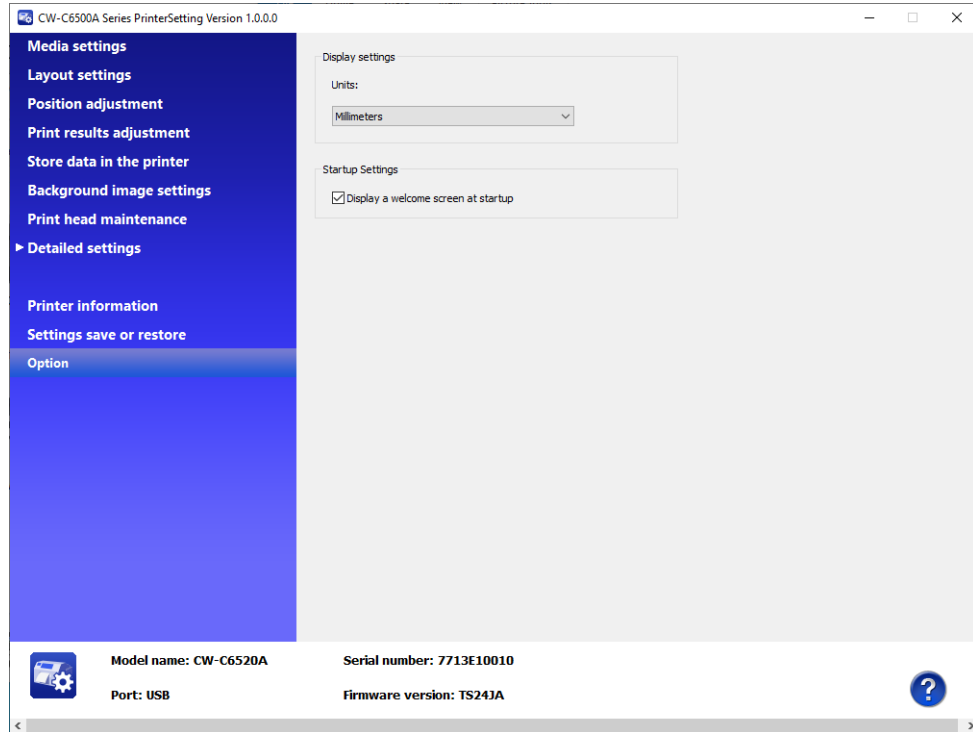

Item		Description
Display settings	Units	Select a unit of length.
Startup Settings	Display a welcome screen at startup	Select whether to display welcome screen at startup.



The [Units] setting is for PrinterSetting itself. It cannot be applied to the printer and the printer driver.

## Operation Panel Settings

The following tables show the menu items and options available on the operation panel with their default settings and whether they can be locked with Lock Setting of the System Administration settings. For more details about the Lock Setting, see "[Restricting Operation of the Operation Panel \(Lock Setting function\)](#)" on page 294.

Setting menu	Settings	Default	Lock Setting			
			General Settings	Printer Settings	Media Settings	
Media Setting						
Media Type						
	Plain Paper	Matte Paper	-	-	✓	
	Matte Paper		-	-	✓	
	Synthetic		-	-	✓	
	Texture Paper		-	-	✓	
	Glossy Paper		-	-	✓	
	Glossy Film		-	-	✓	
	High Glossy Paper		-	-	✓	
Media Detect						
	Gap	Gap	-	-	✓	
	Black Mark		-	-	✓	
	None		-	-	✓	
Media Source						
	Internal	Internal	-	-	✓	
	Rear Feed		-	-	✓	
Media Form						
	Roll	Roll	-	-	✓	
	Fanfold		-	-	✓	
Media Layout						
Label Width						
	CW-C6000 Series	21.4 to 112.0[mm]/ 0.84 to 4.41[inch]	108.0[mm]/ 4.25[inch]	-	-	✓
	CW-C6500 Series	21.4 to 215.9[mm]/ 0.84 to 8.50[inch]	211.9[mm]/ 8.34[inch]	-	-	✓

Setting menu	Settings	Default	Lock Setting			
			General Settings	Printer Settings	Media Settings	
Label Length						
	CW-C6000 Series	8 to 609.6[mm]/0.31 to 24[inch]	152.4[mm]/6[inch]	-	-	✓
	CW-C6500 Series	8 to 609.6[mm]/0.31 to 24[inch]	304.8[mm]/12[inch]	-	-	✓
Gap between Labels						
	Black mark/gap: 2 to 6[mm]/ 0.08 to 0.24[inch]	3[mm]/ 0.12[inch]	-	-	-	✓
	None 0 to 6[mm]/ 0 to 0.24[inch]	3[mm]/ 0.12[inch]	-	-	-	✓
Left & Right Gap*1						
CW-C6000 Series						
	Auto cutter model	0.0 to 6.0[mm]/ 0.0 to 0.24[inch]	2.0mm/ 0.08[inch]	-	-	✓
	Peeler model	0.0 to 2.0[mm]/ 0.0 to 0.08[inch]*	2.0mm/ 0.08[inch]	-	-	✓
CW-C6500 Series						
	Auto cutter model	0.0 to 6.0[mm]/ 0.0 to 0.24[inch]	2.0mm/ 0.08[inch]	-	-	✓
	Peeler model	0.0 to 2.0[mm]/ 0.0 to 0.08[inch]*	2.0mm/ 0.08[inch]	-	-	✓
Print Position Adjustment						
	Top Position * Adjust the print start position on the media	-10.9 to +10.9[mm] / -0.43 to +0.43[inch]	0[mm]/0[inch]	-	-	✓
	Left Position * Adjust the print start position on the media	-2.0 to +2.0[mm] / -0.08 to +0.08[inch]	0[mm]/0[inch]	-	-	✓
	Paper Top Position Adjustment	-1.5 to +1.5[mm] / -0.06 to +0.06[inch]	0[mm]/0[inch]	-	-	✓
Left Margin * Adjust image position in the printable area This is a command-direct function. If using the printer driver, set this to "0".						
	CW-C6000 Series	-108.0 to +108.0[mm] / -4.25 to +4.25[inch]	0[mm]/0[inch]	-	-	✓
	CW-C6500 Series	-211.9 to +211.9[mm] / -8.34 to +8.34[inch]	0[mm]/0[inch]	-	-	✓

Setting menu	Settings	Default	Lock Setting		
			General Settings	Printer Settings	Media Settings
Media Size Notice	On	Off	-	-	✓
	Off		-	-	✓
Maintenance					
Print Head Nozzle Check	-	-	-	-	-
Print Head Cleaning	-	-	-	-	-
Power Cleaning	-	-	-	-	-
Ink Cartridge Replacement	-	-	-	-	-
Replace Maintenance Box	-	-	-	-	-
Print Head Alignment					
	Vertical Alignment	-	-	✓	-
	Horizontal Alignment		-	✓	-
Calibration					
	Simple Media Detect	-	-	✓	-
	Media Detect		-	✓	-
	Roll Media Tension		-	✓	-
Nozzle check settings					
Nozzle check settings	On	On	-	✓	-
	Off		-	✓	-
Nozzle Check Interval	1 to 13000 [copies]	500 [copies]	-	✓	-
Operation At Clogged Nozzle	Notify	Notify	-	✓	-
	Continue Printing		-	✓	-
Threshold Of Clogged Nozzles	0 to 16 [nozzles]	6 [nozzles]	-	✓	-
Cleaning After Nozzle Check	On	On	-	✓	-
	Off		-	✓	-
Periodic Cleaning	HH:MM (in increments of 1 min.)	0:00	-	✓	-
Ink Discharging	-	-	-	✓	-

Setting menu	Settings	Default	Lock Setting		
			General Settings	Printer Settings	Media Settings
General Settings					
Basic Settings					
LCD Brightness	1 to 5	5	✓	-	-
Sound					
	Off	Medium	✓	-	-
	Low		✓	-	-
	Medium		✓	-	-
	High		✓	-	-
	Maximum		✓	-	-
Error Notice					
Error Notice	Off	On	✓	-	-
	On		✓	-	-
Repeat Error Notice	Off	Off	✓	-	-
	On		✓	-	-
Length Unit					
	mm	mm	✓	-	-
	inch		✓	-	-
Max Data Wait Time	1 to 15	1	✓	-	-
Sleep Timer					
	Off	On (15 min.)	✓	-	-
	On (1 to 240 min.)		✓	-	-
Circuit Breaker Interlock Startup					
	On	Off	✓	-	-
	Off		✓	-	-
Date/Time Settings					
Date/Time	yyyy.mm.dd	yyyy.mm.dd	✓	-	-
	mm.dd.yyyy		✓	-	-
	dd.mm.yyyy		✓	-	-
Daylight Saving Time	Off	Off	✓		
	On		✓		

Setting menu	Settings	Default	Lock Setting			
			General Settings	Printer Settings	Media Settings	
	Time Difference	-12:45 to +13:45 (in increments of 15 min.)	-	✓	-	-
Language						
	Nederlands	한국어 (for Korea) Settings 简体中文 (for China and Hong Kong) Settings English (for other counties and regions)	-	-	-	-
	English		-	-	-	-
	Français		-	-	-	-
	Deutsch		-	-	-	-
	Ελληνικά		-	-	-	-
	Italiano		-	-	-	-
	日本語		-	-	-	-
	한국어		-	-	-	-
	Polski		-	-	-	-
	Português		-	-	-	-
	Русский		-	-	-	-
	简体中文		-	-	-	-
	Español		-	-	-	-
	繁體中文		-	-	-	-
	Türkçe	-	-	-	-	
Background Color						
	Gray	Black	-	-	-	-
	Black		-	-	-	-
	White		-	-	-	-
Keyboard						
	QWERTY	QWERTY	-	-	-	-
	AZERTY		-	-	-	-
	QWERTZ		-	-	-	-
Control Panel Button Settings						
Cut (Auto cutter model only)						
	Enable	Enable	✓	-	-	-
	Disable		✓	-	-	-

Setting menu	Settings	Default	Lock Setting		
			General Settings	Printer Settings	Media Settings
Cancel	Enable	Enable	✓	-	-
	Disable		✓	-	-
	Feed (Auto cutter model only)				
	Enable	Enable	✓	-	-
	Disable		✓	-	-
Peeler Reset (Peeler model only)					
	Enable	Enable	✓	-	-
	Disable		✓	-	-
Printer Settings					
Print Settings					
Quality					
	High Speed	Normal	-	✓	-
	Speed		-	✓	-
	Normal		-	✓	-
	Quality		-	✓	-
	Max Quality		-	✓	-
Resolution <sup>*2</sup>					
	200dpi	600dpi	-	✓	-
	300dpi		-	✓	-
	600dpi		-	✓	-
Command Character					
Control Prefix	0X20 to 7E	0X7E	-	✓	-
Format Command Prefix	0X20 to 7E	0X5E	-	✓	-
Delimiter Characters	0X20 to 7E	0X2C	-	✓	-

Setting menu	Settings	Default	Lock Setting			
			General Settings	Printer Settings	Media Settings	
Image Quality						
Color Adjustment Mode						
	EPSON Vivid Color	EPSON Preferred Color	-	✓	-	
	EPSON Preferred Color			✓		
	None		-	✓	-	
Manual Color Adjustments						
	Light	-25 to +25	0	-	✓	-
	Saturation	-25 to +25	0	-	✓	-
	Contrast	-25 to +25	0	-	✓	-
	Tone -Cyan	-25 to +25	0	-	✓	-
	Tone -Magenta	-25 to +25	0	-	✓	-
	Tone -Yellow	-25 to +25	0	-	✓	-
	Ink Profile	-6 to +4 (in increments of 1)	0	-	✓	-
	Ratio of Black to Composite	-6 to 0 (in increments of 1)	0 * Changes to "-2" when; Black ink type is matte black, Media type is Plain Paper, Matte Paper or Texture Paper Print Quality is Speed, Normal, or Quality	-	✓	-
	Dry Time	0.0 to 5.0 sec. (in increments of 0.1 sec.)	0.0 sec.	-	✓	-
Nozzle Verification Technology						
	Enable	Enable	-	✓	-	
	Disable		-	✓	-	
	Bar Width Adjustment	- 2 to +2 (in increments of 1)	0	-	✓	-

Setting menu	Settings	Default	Lock Setting			
			General Settings	Printer Settings	Media Settings	
Print Options						
Print Mode						
	Cut (Auto cutter model only)	For auto cutter model: Stop at Cut Position  For peeler model: Peel-Off	-	✓	-	
	Stop at Cut Position (Auto cutter model only)		-	✓	-	
	Stop at Peel-Off Position (Auto cutter model only)		-	✓	-	
	Peel-Off (Peeler model only)		-	✓	-	
	Peel-Off for Auto Labeler (Peeler model only)		-	✓	-	
	Rewind		-	✓	-	
	Cut Position (Auto cutter model only)	-10.8 to +10.8[mm] / -0.425 to +0.425[inch]	0[mm]/0[inch]	-	✓	-
Peel-Off Position (Peeler model only)						
	Paste by Hand	-10.8 to +10.8[mm] / -0.425 to +0.425[inch]	0[mm]/0[inch]	-	✓	-
	Paste by Machine	-10.8 to +10.8[mm] / -0.425 to +0.425[inch]	0[mm]/0[inch]	-	✓	-
Set Timing of Back Feed						
	Back Feed Before Print	Back Feed After Print	-	✓	-	
	Back Feed After Print		-	✓	-	
Reprint						
	Enable	Enable	-	✓	-	
	Disable		-	✓	-	
Media Hold Pressure						
	Auto	Auto	-	✓	-	
	Manual (1 to 10)		-	✓	-	
Max Data Wait Time						
	1 to 15[seconds]	1[second]	-	✓	-	
Cancel Action						
	Job ONLY	Job ONLY	-	✓	-	
	Job/RAM Drive		-	✓	-	

Setting menu	Settings	Default	Lock Setting		
			General Settings	Printer Settings	Media Settings
External I/O Settings					
End print signal					
	Disable Signal	Disable Signal	-	✓	-
	Low level Enable		-	✓	-
	High level Enable		-	✓	-
	Low Pulse Enable		-	✓	-
	High Pulse Enable		-	✓	-
Data ready signal					
	Disable Signal	Disable Signal	-	✓	-
	Low level Enable		-	✓	-
	High level Enable		-	✓	-
Missing dot detected signal					
	Disable Signal	Disable Signal	-	✓	-
	Low level Enable		-	✓	-
	High level Enable		-	✓	-
Head maintenance signal					
	Disable Signal	Disable Signal	-	✓	-
	Low level Enable		-	✓	-
	High level Enable		-	✓	-
Printer ready signal					
	Disable Signal	Disable Signal	-	✓	-
	Low level Enable		-	✓	-
	High level Enable		-	✓	-
Warning signal					
	Disable Signal	Disable Signal	-	✓	-
	Low level Enable		-	✓	-
	High level Enable		-	✓	-

Setting menu	Settings	Default	Lock Setting		
			General Settings	Printer Settings	Media Settings
Error & Pause Signal					
	Disable Signal	Disable Signal	-	✓	-
	Normally High, Low on Error		-	✓	-
	Normally Low, High on Error		-	✓	-
	Normally High, Low on Error/Pause		-	✓	-
	Normally Low, High on Error/Pause		-	✓	-
Ink low signal					
	Disable Signal	Disable Signal	-	✓	-
	Low level Enable		-	✓	-
	High level Enable		-	✓	-
Ink end signal					
	Disable Signal	Disable Signal	-	✓	-
	Low level Enable		-	✓	-
	High level Enable		-	✓	-
Paper end signal					
	Disable Signal	Disable Signal	-	✓	-
	Low level Enable		-	✓	-
	High level Enable		-	✓	-
Pause signal					
	Ignore signal	Ignore signal	-	✓	-
	Execute at Low		-	✓	-
Head cleaning signal					
	Ignore signal	Ignore signal	-	✓	-
	Execute at Low		-	✓	-
Missing dot check signal					
	Ignore signal	Ignore signal	-	✓	-
	Execute at Low		-	✓	-

Setting menu	Settings	Default	Lock Setting		
			General Settings	Printer Settings	Media Settings
	Feed signal				
	Ignore signal	Ignore signal	-	✓	-
	Execute at Low		-	✓	-
	Start print signal				
	Ignore signal	Ignore signal	-	✓	-
	Execute at Low		-	✓	-
	Execute during Low		-	✓	-
	Re-print signal				
	Ignore signal	Ignore signal	-	✓	-
	Execute at Low		-	✓	-
	Actions when Replacing Media				
	Feed (peeler model only)	Auto cut model: Feed without Cut Peeler model: Feed	-	✓	-
	Feed with Cut (auto cut model only)			✓	
	Feed without Cut (auto cut model only)			✓	
Not Feed	-		✓	-	
Calibration	-		✓	-	
Short Calibration	-		✓	-	
Check Media Size	-		✓	-	
Actions on Power On					
Feed (peeler model only)	Not Feed	-	✓	-	
Feed with Cut (auto cut model only)					
Feed without Cut (auto cut model only)					
Not Feed		-	✓	-	
Calibration		-	✓	-	
Short Calibration		-	✓	-	
Check Media Size		-	✓	-	

Setting menu	Settings	Default	Lock Setting			
			General Settings	Printer Settings	Media Settings	
Network Settings						
Network Status						
	Wired LAN Status	-	-	✓	-	-
	Print Status Sheet	-	-	✓	-	-
	Connection Check	-	-	✓	-	-
Advanced						
	Device Name	-	-	✓	-	-
	TCP/IP	-	-	✓	-	-
	Proxy Server	-	-	✓	-	-
IPv6 Address						
	Enable	Enable	✓	-	-	
	Disable		✓	-	-	
Link Speed & Duplex						
	Auto	Auto	✓	-	-	
	100BASE-TX Auto		✓	-	-	
	10BASE-T Half Duplex		✓	-	-	
	10BASE-T Full Duplex		✓	-	-	
	100BASE-TX Half Duplex		✓	-	-	
	100BASE-TX Full Duplex		✓	-	-	
Redirect HTTP to HTTPS						
	Enable	Enable	✓	-	-	
	Disable		✓	-	-	
	Disable IPsec/IP Filtering	-	-	✓	-	-
	Disable IEEE802.1X	-	-	✓	-	-

Setting menu	Settings	Default	Lock Setting			
			General Settings	Printer Settings	Media Settings	
System Administration						
	Clear Internal Memory Data	-	-	✓	-	-
Security Settings						
Admin Settings						
Admin Password						
	Change	-	✓	-	-	
	Reset	-	✓	-	-	
Lock Setting						
	On	Off	✓	-	-	
	Off	Off	✓	-	-	
General Settings						
	On	-	✓	-	-	
	Off	*Fixed to "On" when Lock Setting is set to On.	✓	-	-	
Printer Settings						
	On	Off	✓	-	-	
	Off	Off	✓	-	-	
Media Settings						
	On	Off	✓	-	-	
	Off	Off	✓	-	-	
Restore Default Settings						
	Network Settings	-	-	✓	-	-
	Media Detect	-	-	✓	-	-
	Roll Media Tension	-	-	✓	-	-
	All Settings	-	-	✓	-	-
Language						
		-	-	-	-	-
Favorite Settings						
		-	-	-	-	-
Supply Status						
		-	-	-	-	-
Printer Status/Print						
	Firmware Version	-	-	-	-	-

Setting menu	Settings	Default	Lock Setting		
			General Settings	Printer Settings	Media Settings
Print Status Sheet					
	Configuration Status Sheet	-	-	-	-
	Font List	-	-	-	-
	Barcode List	-	-	-	-
	Image List	-	-	-	-
	Template List	-	-	-	-
	Network	-	-	-	-
Maintenance Counters					
	Total Length	-	-	-	-
	Length 1 (Reset counter 1)	-	-	-	-
	Length 2 (Reset counter 2)	-	-	-	-
	Total Pages	-	-	-	-
	Pages 1 (Reset counter 1)	-	-	-	-
	Pages 2 (Reset counter 2)	-	-	-	-
	Total CR	-	-	-	-
	Total Auto Cut (Auto cutter model only)	-	-	-	-
	Ink Path Valve	-	-	-	-

\*1 Although the Left & Right Gap can be set to up to 6.0 mm (0.24 inches), the peeler model is not guaranteed to operate correctly if this value is set larger than 2.0 mm (0.08 inches). The paper might not be fed correctly, resulting in a paper jam.

\*2 The resolution setting refers to the setting that is used to specify the resolution for the printer being replaced, when replacing a monochrome thermal printer or similar printer with a ColorWorks printer. For details, see ["Relationship Between "Print Resolution" and "Resolution Settings"" on page 359.](#)

## Web Config

Web Config is an application software that allows you to check or change the printer settings using a web browser on a computer.

To use Web Config, you need to set up an IP address to the printer in advance.

Connect the computer to the same network as the printer.

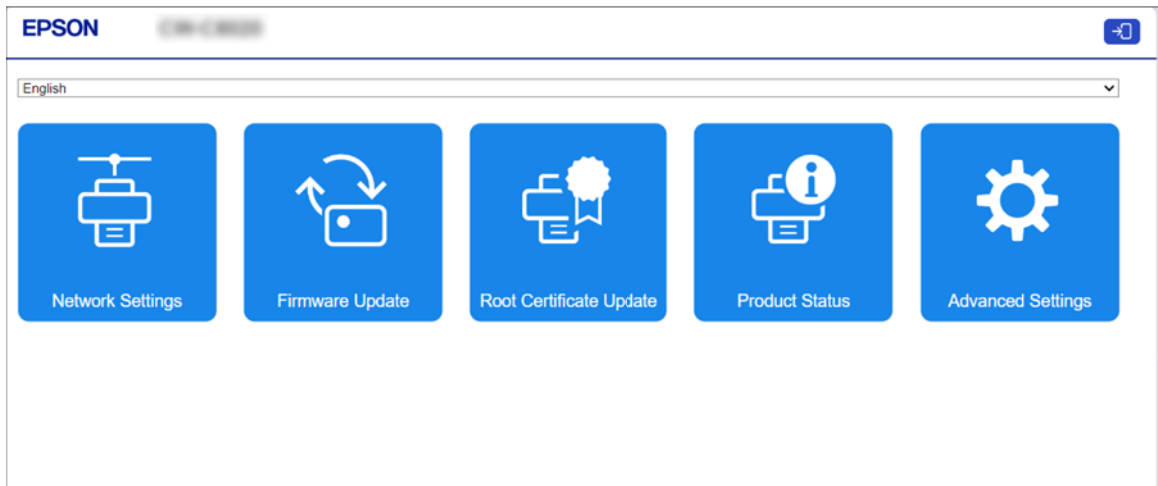

You cannot change settings to make administrator login unnecessary. If you forgot the administrator password, you can reset it. ("[Resetting the Administrator Password](#)" on page 296)

## How to Start Web Config

Start a web browser on a computer or device that is connected via a network, and then type the printer IP address into the browser. To change the printer settings, log in from [Administrator Login] in the top right of the screen.

When logging in to Web Config, you need to enter your user name and password.

- If there is a password label applied to the rear of the printer  
User name: Arbitrary characters (This is not used for login.)  
Password: The value for "PASSWORD" on the password label



In the example shown, the initial password is 03212791.

- If there is no password label  
The login screen varies depending on the setting for the administrator password for the printer.
  - \* If the administrator password for the printer is not set  
The password setting screen appears. Set the user name and password.  
User name: Blank, or an arbitrary character string  
Password: An arbitrary character string  
This is automatically reflected as the administrator password for the printer.



- If the user name is set to blank  
You can enter an arbitrary character string for subsequent logins. (This is not used for login.)
- If the user name is not set to blank  
Enter the set character string for subsequent logins.

- \* When setting the administrator password for the printer  
Enter your user name and password on the login screen for Web Config.  
User name: Blank, or an arbitrary character string (if set to a blank)  
Set character string (if user name is not set to a blank)  
Password: Administrator password for the printer

Enable the JavaScript on the browser. Because the communication with the printer uses a self-signed certificate of the printer over HTTPS, a warning message is displayed on the browser when you start Web Config.

### Communication over HTTPS

IPv4: `https://IP address of the printer`  
IPv6: `https://[IP address of the printer]`

### Communication over HTTP

IPv4: `http://IP address of the printer`  
IPv6: `http://[IP address of the printer]`

### Examples

IPv4:  
`https://192.0.2.111/`  
`http://192.0.2.111/`  
IPv6:  
`https://[2001:db8::1000:1]/`  
`http://[2001:db8::1000:1]/`

## Epson Device Admin

Epson Device Admin is multifunctional software that allows you to manage printers on a network.

It offers the following functions.

- Monitoring and managing networked printers
- Issuing a detailed report on consumables and printer status
- Updating printer's firmware
- Installing a new networked printer
- Configuring various settings of a networked printer
- Configuring various settings of multiple networked printers at a time

You can download Epson Device Admin from the Epson website.



### **IMPORTANT**

For the CW-C6000/6500 Series printers, Epson Device Admin supports Ethernet connection only. It cannot be used if the printer is connected via USB.

## ***EPSON Cloud Solution PORT***

EPSON Cloud Solution PORT supports customers in maximizing production by visualizing on-site conditions, such as printer operation information and error status, via PC and mobile devices.

For details on the solution, see the following.

[https://support.epson.net/p\\_doc/b9e/](https://support.epson.net/p_doc/b9e/)



However, this product does not support color management and workflow solutions.

## Using Loftware's Loftware Cloud

Loftware Cloud is a cloud-based label management system from Loftware. The entire process of creating labels, including design, management, data linkage, and printing, can be managed in the cloud. In order to print from Loftware Cloud, the printer must be registered with Loftware Cloud and configured in Web Config or Epson Device Admin.

["Registering a Printer \(Web Config\)" on page 247](#)

["Registering a Printer \(Epson Device Admin\)" on page 254](#)



For more information about how to use Loftware Cloud, select  in the upper right corner to view the Help section.

### Registering a Printer (Web Config)

- 1 **Open Web Config, and log in from the [Log in].**  
Web Config

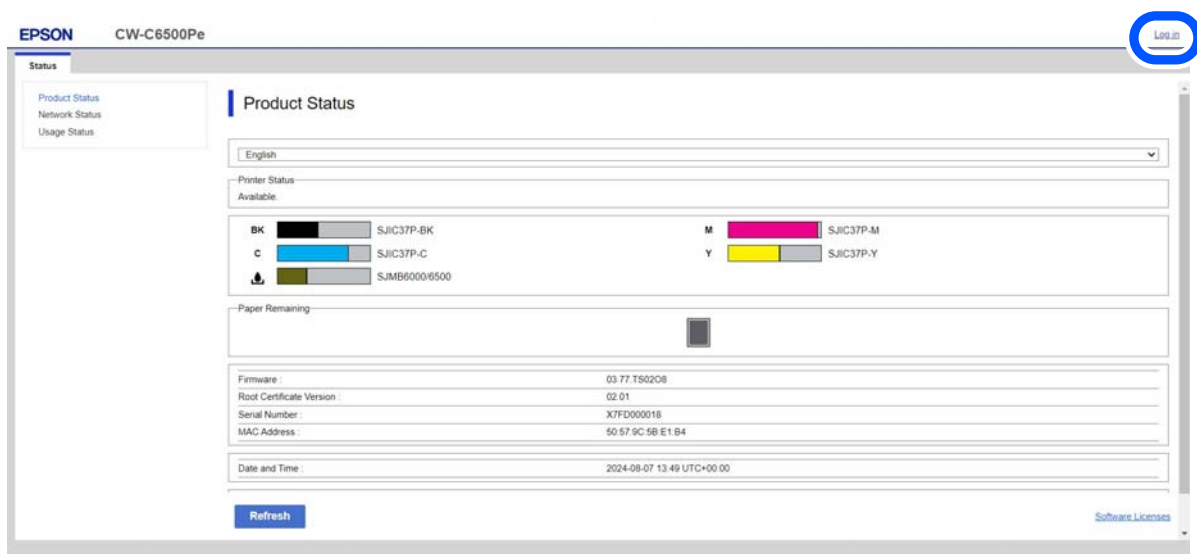

For details on Web Config, see ["Web Config" on page 243](#).

## 2 Check the following settings in the [Network] tab.

- IP Address
- Subnet Mask
- Default Gateway
- Primary DNS Server
- Secondary DNS Server
- Proxy Server
- Proxy Server Port Number

### Web Config

The screenshot shows the EPSON CW-C4520 Web Config interface. The 'Network' tab is selected, and the 'Basic' sub-tab is active. The following settings are highlighted with blue boxes:

- IP Address : 192.168.1.10
- Subnet Mask : 255.255.252.0
- Default Gateway : 192.168.1.1
- Primary DNS Server : 192.168.0
- Secondary DNS Server : 192.168.0
- Proxy Server : 192.168.1.10
- Proxy Server Port Number : 8080

Other visible settings include:

- Device Name : EPSONA5C1BA
- Location :
- Obtain IP Address :  Auto  Manual
- Set using BOOTP :  Enable  Disable
- Set using Automatic Private IP Addressing :  Enable  Disable
- DNS Host Name : EPSONA5C1BA
- DNS Domain Name Setting :  Auto  Manual
- DNS Domain Name :
- Register the network interface address to DNS :  Enable  Disable
- IPv6 Setting :  Enable  Disable
- IPv6 Privacy Extension :  Enable  Disable
- IPv6 DHCP Server Setting :  Do Not Use  Use
- IPv6 Address :
- IPv6 Address Default Gateway :
- IPv6 Link-Local Address : fe80::dec:d:2ff:fea5:c1ba/64
- IPv6 Stateful Address :
- IPv6 Stateless Address 1 :

A 'Next' button is visible at the bottom of the configuration page.

## 3 Open Software Control Center and sign in.

Please get the account information to sign in from Software company.

## 4 Select [Printers] in the tree on the left, and then select [Cloud Printers] - [Add]. Loftware Cloud

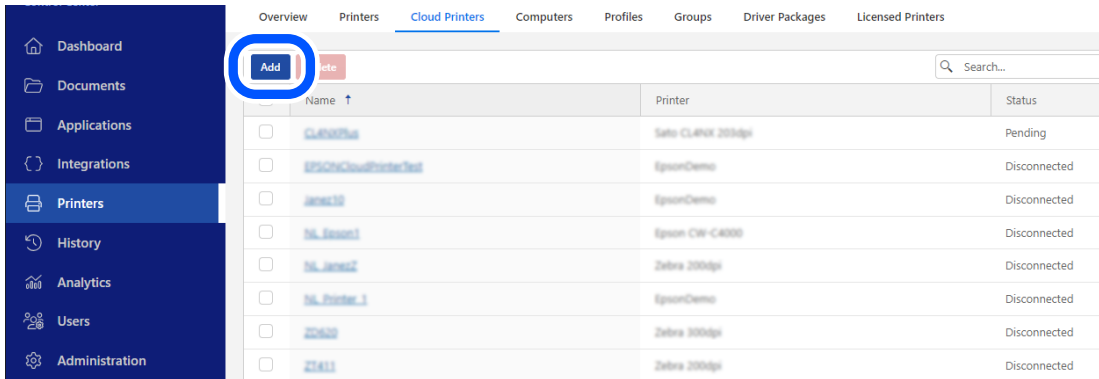

Overview Printers **Cloud Printers** Computers Profiles Groups Driver Packages Licensed Printers

**Add**

	Name ↑	Printer	Status
<input type="checkbox"/>	CLM375a	Sato CLM375 200dpi	Pending
<input type="checkbox"/>	EPSONCloudPrinter32	EpsonDemo	Disconnected
<input type="checkbox"/>	329633	EpsonDemo	Disconnected
<input type="checkbox"/>	34_329631	Epson CW-C4000	Disconnected
<input type="checkbox"/>	34_329632	Zebra 200dpi	Disconnected
<input type="checkbox"/>	34_Printer_1	EpsonDemo	Disconnected
<input type="checkbox"/>	229633	Zebra 300dpi	Disconnected
<input type="checkbox"/>	22811	Zebra 200dpi	Disconnected

## 5 Set [Name] and [Printer] for the new cloud printer. Loftware Cloud



Cloud Printer Settings

① Name

② Printer

Serial number

[Where can you find your printer's serial number?](#)

Server URL

- (1) [Name] Enter the name you want to display on Loftware Cloud.
- (2) [Printer] Select the printer to set as a cloud printer.



When you select [Printer], [Serial number] and [Server URL] will appear.

- 6** Open [Status] - [Product Status] in Web Config, copy the serial number of the printer, and paste it into [Serial number] in Loftware Cloud.  
Web Config

The image shows two screenshots from a web interface. The top screenshot is from 'Web Config' under the 'Status' tab, specifically the 'Product Status' section. It displays printer information including ink levels for BK, C, M, and Y, and a 'Serial Number' field with the value '477088016'. A blue circle highlights the 'Serial Number' field, and a blue arrow points from it to the 'Serial number' field in the bottom screenshot. The bottom screenshot is from 'Loftware Cloud' under the 'Printers' tab, showing the 'Add New Cloud Printer' form. The 'Serial number' field is highlighted with a blue circle, and a blue arrow points to it from the 'Serial Number' field in the top screenshot. The 'Save' button is also highlighted with a blue circle.

- 7** Select [Save].  
Loftware Cloud

The image shows a screenshot of the 'Loftware Cloud' interface, specifically the 'Add New Cloud Printer' form. The 'Save' button is highlighted with a blue circle. The form fields are filled with the same information as in the previous screenshot: Name 'Test\_CW-C4000', Printer 'Epson CW-C4000', and Serial number '477088016'. The 'Server URL' field contains 'https://epsonimg.gdn.epson.com/epson.com'. The 'Printers' tab is selected in the top navigation bar.

## 8 Select the saved printer from [Cloud Printers]. Loftware Cloud

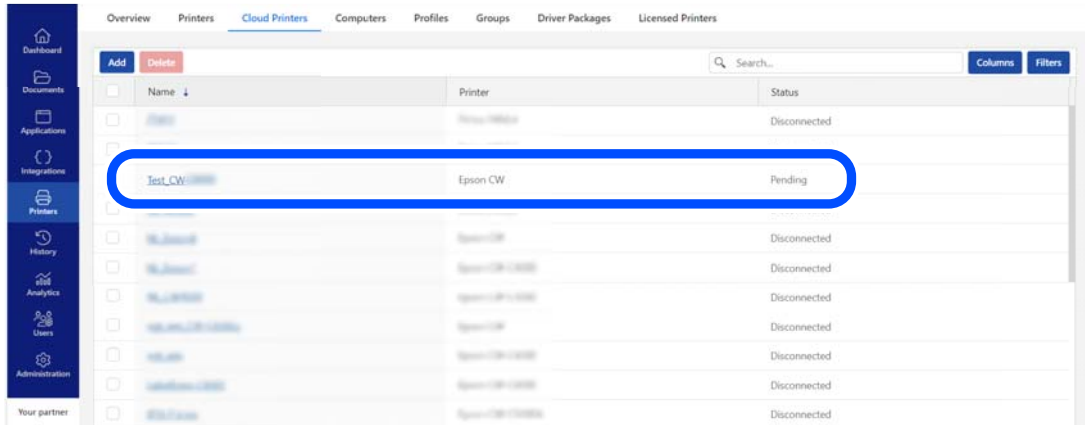

## 9 Click the button to copy the server URL and paste it into the following field in Web Config.

[Network] - [Loftware Cloud] - [Basic] - [URL]

Loftware Cloud

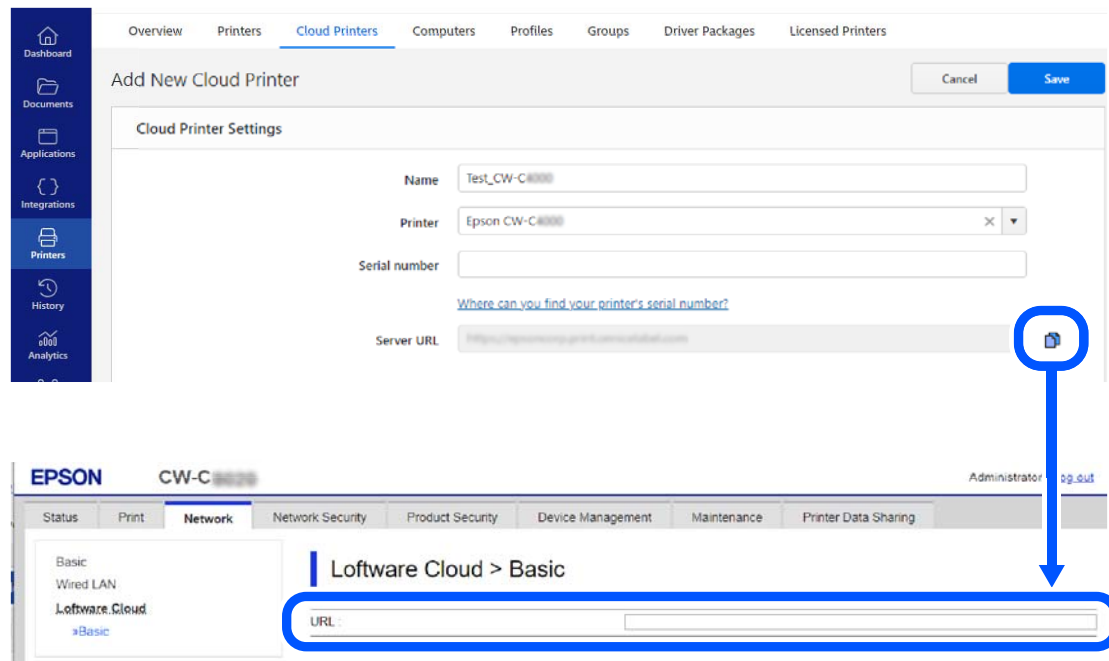

# 10 Click [OK]. Web Config

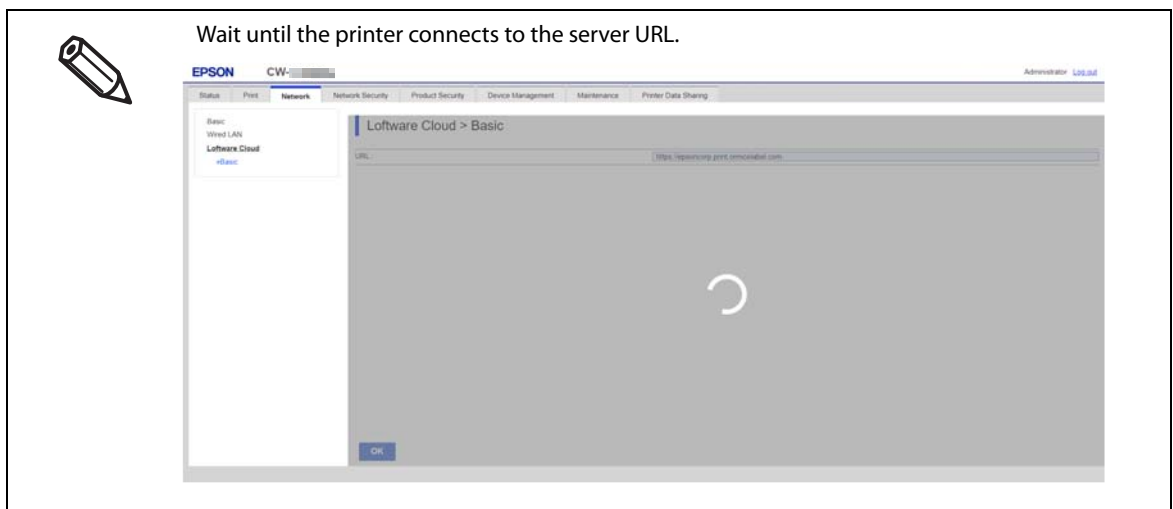
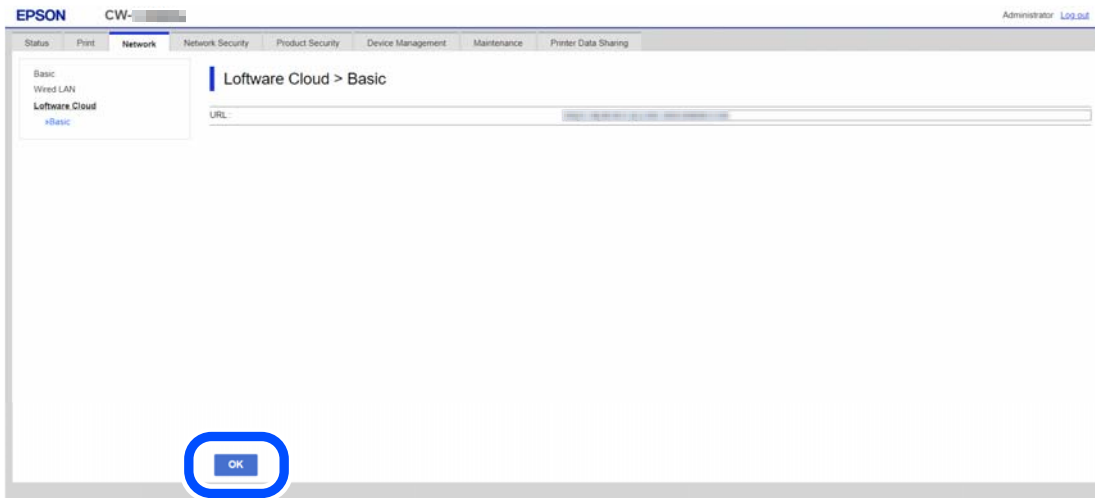

## 11 Check the connection results displayed on the screen.

- If the message "Setup complete" is displayed, the printer has been successfully registered.

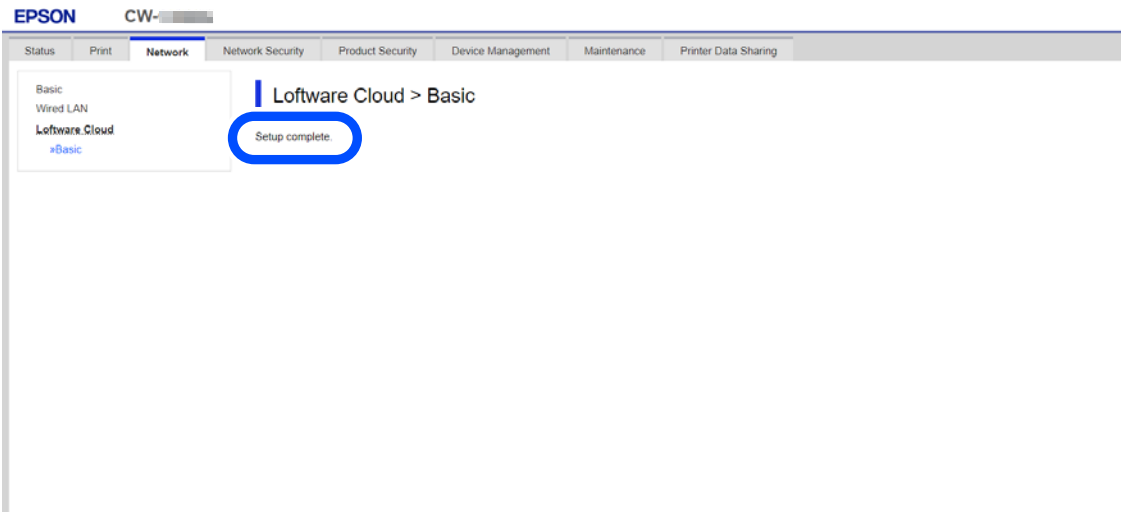

- If an error number is displayed, the printer registration has failed. Check the solutions listed in ["Error Number List" on page 266](#). In this example, the error number is 910005.

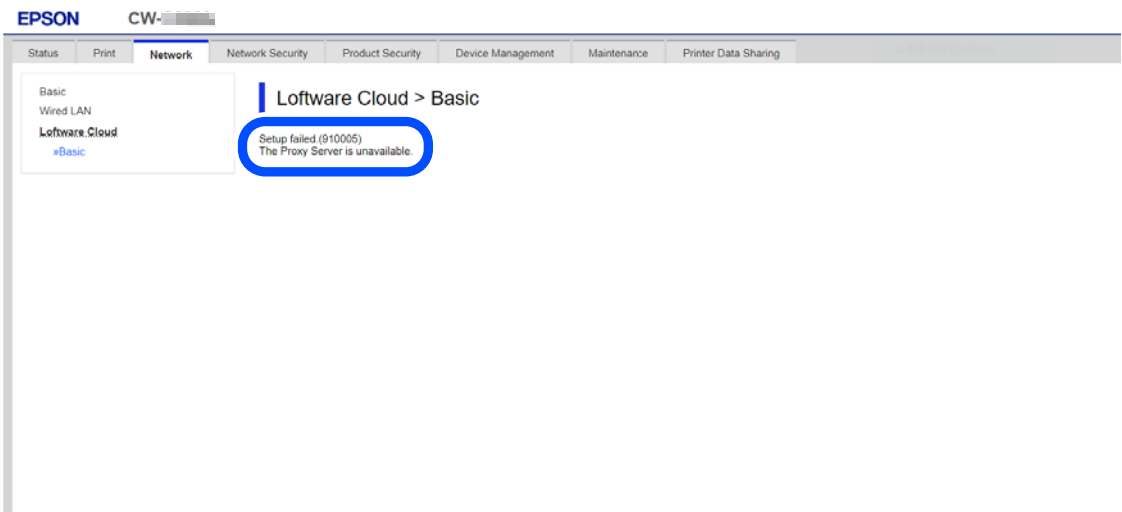

The printer's connection status can also be checked from Loftware Cloud.  
[Printers] - [Cloud Printers] - [Status]

The screenshot shows the Loftware Cloud interface. The 'Cloud Printers' tab is selected. A table lists various printers, with one printer, 'TestLW-00000', highlighted by a blue circle. The status of this printer is 'Connected'.

Name	Printer	Status
TestLW-00000	Epson CW	Connected
...	...	Disconnected
...	...	Disconnected
...	...	Disconnected
...	...	Disconnected
...	...	Disconnected
...	...	Disconnected
...	...	Disconnected
...	...	Disconnected

## Registering a Printer (Epson Device Admin)

### 1 Open Epson Device Admin, and select [Device Configuration]. Epson Device Admin

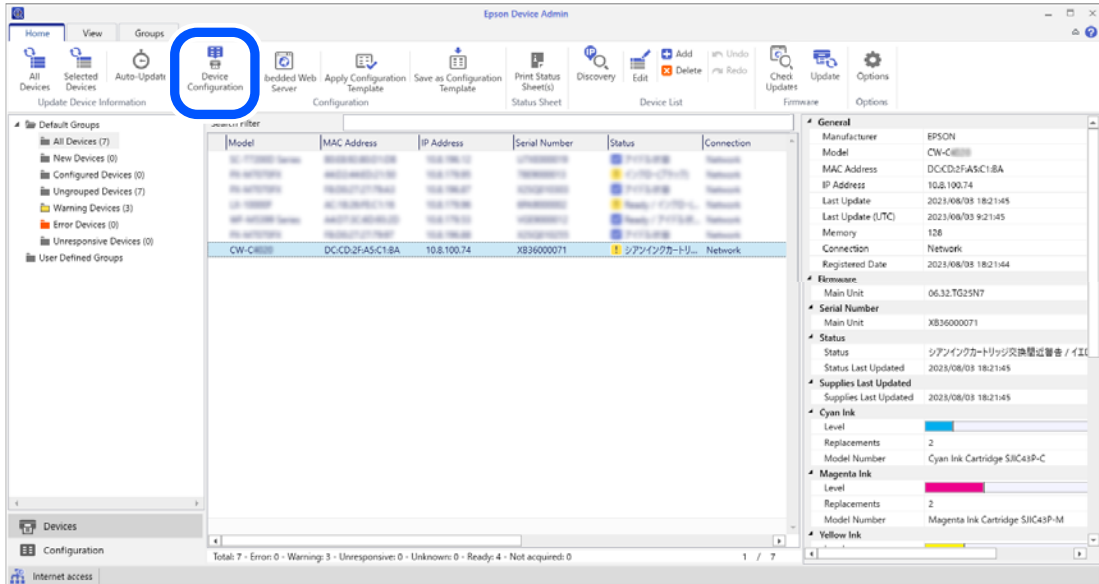

For details on Epson Device Admin, see ["Epson Device Admin" on page 245](#).

The default administrator password is written next to "PASSWORD" on the password label affixed to the rear side of the printer.

## 2 Check the following settings on the "Device Properties" screen.

- IP Address
- Subnet Mask
- Default Gateway
- Primary DNS Server
- Secondary DNS Server
- Proxy Server
- Proxy Server Port Number

[Network] – [TCP/IP] – [Basic]

Method for Specifying IP Address

Automatic  Manual

Set using BOOTP

Set using Automatic Private IP Addressing (APIPA)

IP Address: 10 . 0 . 100 . 1

Subnet Mask: 255 . 255 . 252 . 0

Default Gateway: 10 . 0 . 100 . 1

[Network] – [TCP/IP] – [DNS]

DNS Server Address Settings

Acquire DNS server address automatically

DNS Server Addresses (order of use):

10.0.10.1

10.0.10.2

Add... Edit... Delete Up Down

[Network] – [TCP/IP] – [Internet]

Use proxy server

Proxy Server

Address: 10.0.10.1

Port: 8080

Acquire from browser information.

## 3 Open Software Control Center and sign in.

Please get the account information to sign in from Loftware company.

## 4 Select [Printers] in the tree on the left, and then select [Cloud Printers] - [Add]. Loftware Cloud

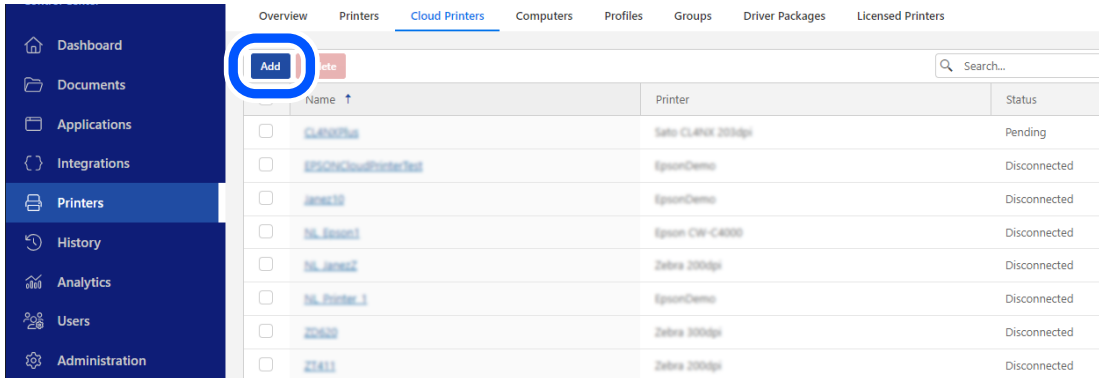

Overview Printers **Cloud Printers** Computers Profiles Groups Driver Packages Licensed Printers

**Add** etc Search...

	Name ↑	Printer	Status
<input type="checkbox"/>	CLM075a	Sato CLM07 2014pr	Pending
<input type="checkbox"/>	EPSONCloudPrinterTest	EpsonDemo	Disconnected
<input type="checkbox"/>	886632	EpsonDemo	Disconnected
<input type="checkbox"/>	NL_Smart1	Epson CW-C4000	Disconnected
<input type="checkbox"/>	NL_Smart2	Zebra 2000pr	Disconnected
<input type="checkbox"/>	NL_Printer_1	EpsonDemo	Disconnected
<input type="checkbox"/>	22620	Zebra 2000pr	Disconnected
<input type="checkbox"/>	22611	Zebra 2000pr	Disconnected

## 5 Set [Name] and [Printer] for the new cloud printer. Loftware Cloud

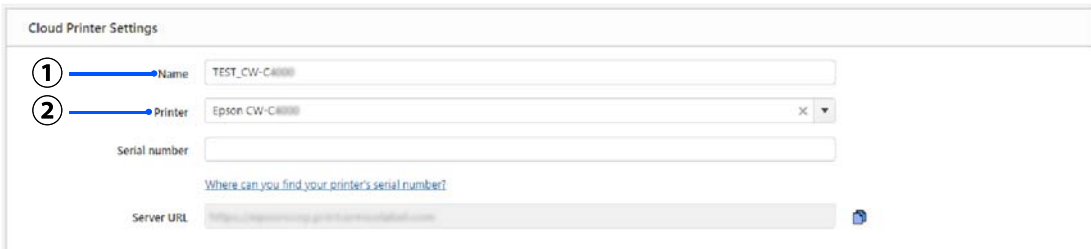

Cloud Printer Settings

① Name TEST\_CW-C4000

② Printer Epson CW-C4000 x

Serial number

[Where can you find your printer's serial number?](#)

Server URL <https://support.epson.com/printerstatus/>

- (1) [Name] Enter the name you want to display on Loftware Cloud.
- (2) [Printer] Select the printer to set as a cloud printer.



When you select [Printer], [Serial number] and [Server URL] will appear.

## 6 Open Epson Device Admin, find the serial number of the printer, and enter it into [Serial number] in Software Cloud.

### Epson Device Admin

The screenshot shows the Epson Device Admin interface. A table lists devices with columns for Model, MAC Address, IP Address, Serial Number, and Status. The serial number 'XB36000071' is circled in blue. A blue arrow points from this serial number to the 'Add New Cloud Printer' form in the Software Cloud interface.

Model	MAC Address	IP Address	Serial Number	Status
SC-772000 Series	80:69:82:80:D1:08	10.8.179.12	1798000079	アイドル状態
FX-A7070FX	44:02:44:ED:21:50	10.8.179.95	7890000113	インク(ブラック)
FX-A7070FX	F8:00:27:27:79:A3	10.8.179.87	3252010303	アイドル状態
L3-10000F	AC:18:28:F6:C1:16	10.8.179.96	6949000002	Ready / インクレ...
WF-M5399 Series	A4:07:3C:4D:83:2D	10.8.179.53		Ready / アイドル...
FX-A7070FX	F8:00:27:27:79:87	10.8.179.88		アイドル状態
CW-C4000	DC:CD:2F:A5:C1:8A	10.8.100.74	XB36000071	シアンインクカートリ...

### Software Cloud

The screenshot shows the 'Add New Cloud Printer' form in the Software Cloud interface. The 'Printer' dropdown is set to 'Epson CW-C4000'. The 'Serial number' field is empty. A blue circle highlights the 'Save' button.

## 7 Select [Save].

### Software Cloud

The screenshot shows the 'Add New Cloud Printer' form in the Software Cloud interface. The 'Save' button is highlighted with a blue circle.

## 8 Select the saved printer from [Cloud Printers]. Logware Cloud

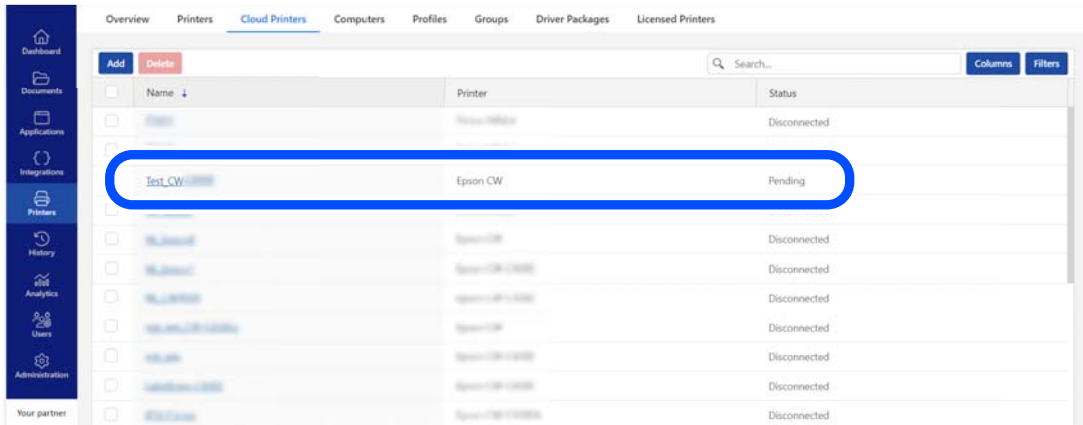

The screenshot displays the 'Cloud Printers' section of the Logware Cloud interface. The interface includes a navigation sidebar on the left with options like Dashboard, Documents, Applications, Integrations, Printers, History, Analytics, Users, and Administration. The main content area shows a table of printers with columns for Name, Printer, and Status. A search bar and 'Add'/'Delete' buttons are at the top. The printer 'Test\_CW' is highlighted with a blue circle.

Name	Printer	Status
[Redacted]	[Redacted]	Disconnected
Test_CW	Epson CW	Pending
[Redacted]	[Redacted]	Disconnected
[Redacted]	[Redacted]	Disconnected
[Redacted]	[Redacted]	Disconnected
[Redacted]	[Redacted]	Disconnected
[Redacted]	[Redacted]	Disconnected
[Redacted]	[Redacted]	Disconnected
[Redacted]	[Redacted]	Disconnected
[Redacted]	[Redacted]	Disconnected

## 9 Click the button to copy the server URL and paste it into the following field in Epson Device Admin.

[Device Configuration] - [Print/Copy] - [Label] - [Loftware Cloud] - [URL]

### Loftware Cloud

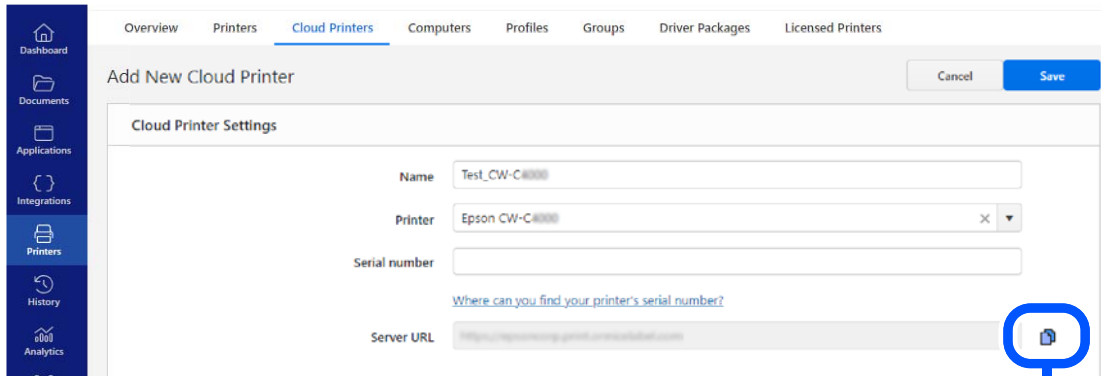

### Epson Device Admin

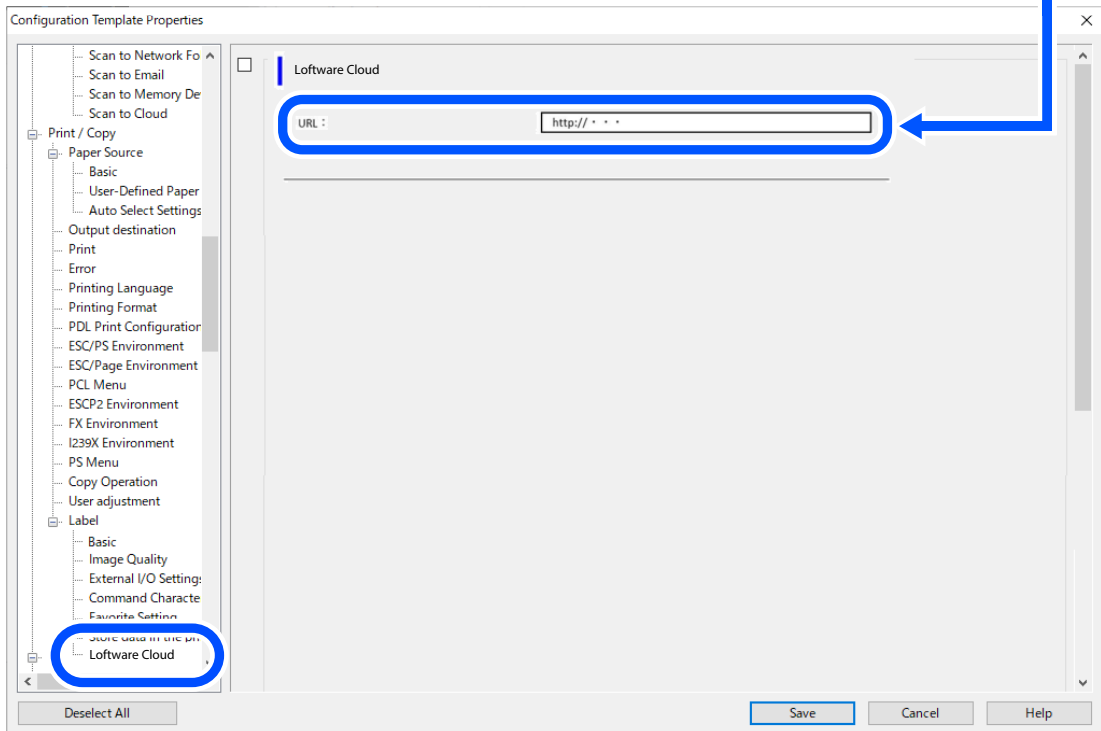

# 10 Select [Save].

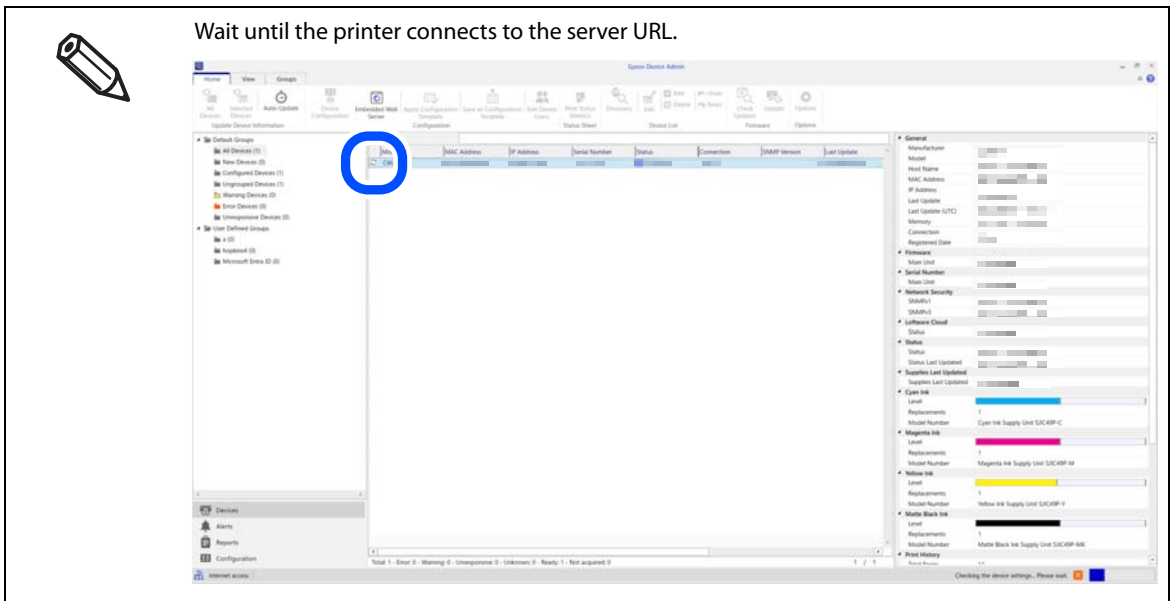

# 11 Check [Software Cloud] - [Status] on the device details screen.

- If "Enabled" is displayed, the printer has been successfully registered.

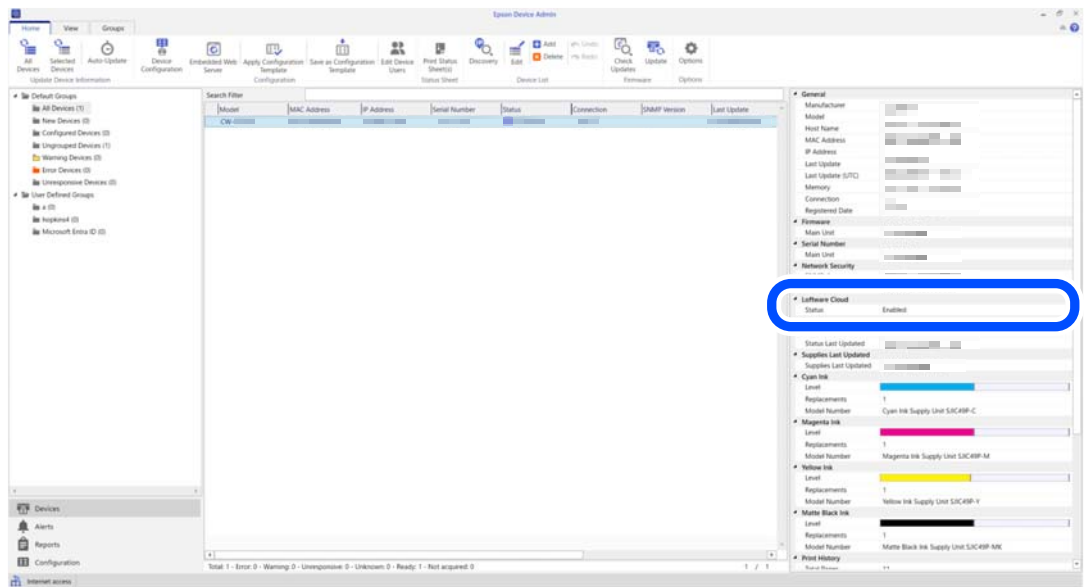

- If "Disabled" or an error number is displayed, the printer registration has failed. Check the solutions listed in "Error Number List" on page 266. In this example, the error number is 910005.

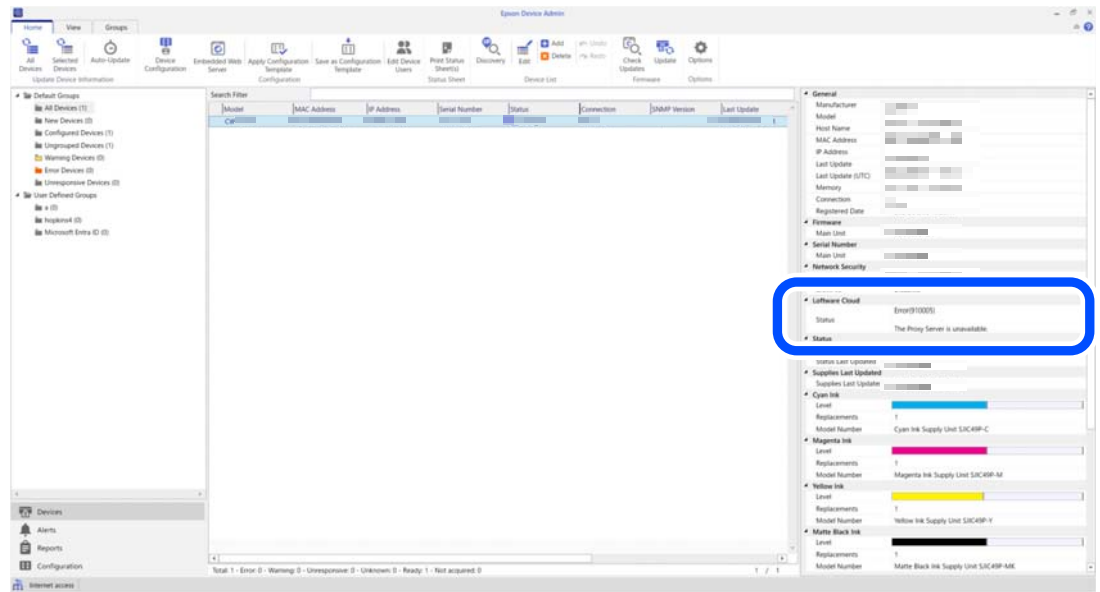

The printer's connection status can also be checked from Loftware Cloud.  
[Printers] - [Cloud Printers] – [Status]

Loftware Cloud

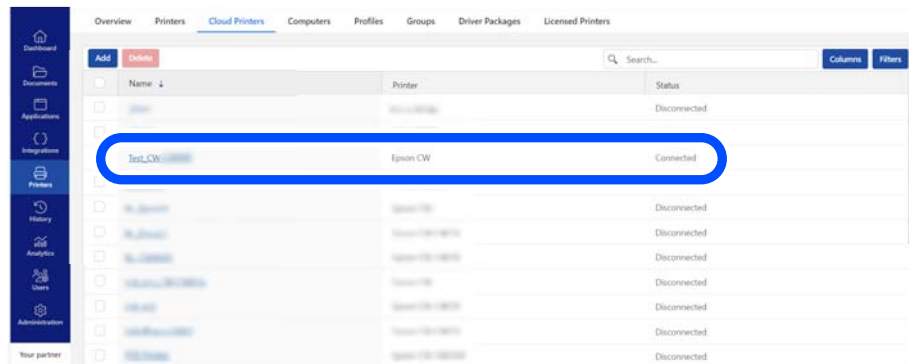

## How to Check the Printer Connection Status

The connection status between the printer and Software Cloud can be checked from Software Cloud, Web Config, and Epson Device Admin.

### Checking from Software Cloud

Select [Printers] from the tree on the left of Software Cloud. The printer's connection status will be displayed under [Cloud Printers] – [Status].

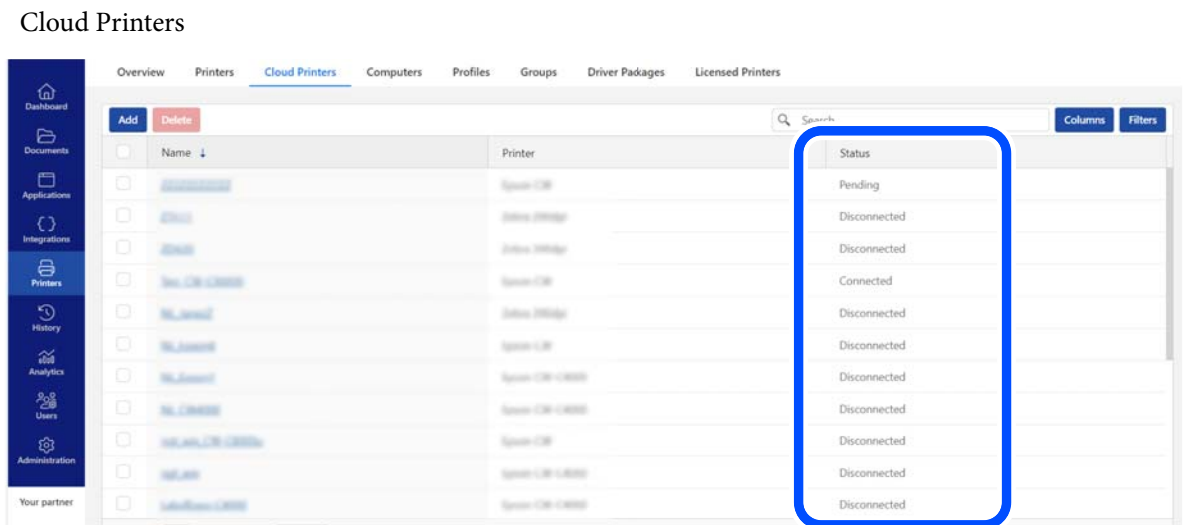

Status	Explanation
Connected	The printer is ready to print. The printer is connected to the Software Cloud server and has been successfully authenticated.
Pending	Printing from the printer is not possible. The printer has never been able to connect to the Software Cloud server.
Disconnected	Printing from the printer is not possible. The following are possible causes. <ul style="list-style-type: none"> <li>• The printer has connected to the Software Cloud server, but is now disconnected.</li> <li>• The Software Cloud server has failed to authenticate the printer.</li> <li>• The printer is not turned on.</li> </ul>

If "Pending" or "Disconnected" is displayed in the "Status" column, check the error number on the Web Config or Epson Device Admin screen, and take action according to the error number.

["Checking from Web Config" on page 263](#)

["Checking from Epson Device Admin" on page 265](#)

## Checking from Web Config

### 1 Open Web Config and click [Log in] to log in.

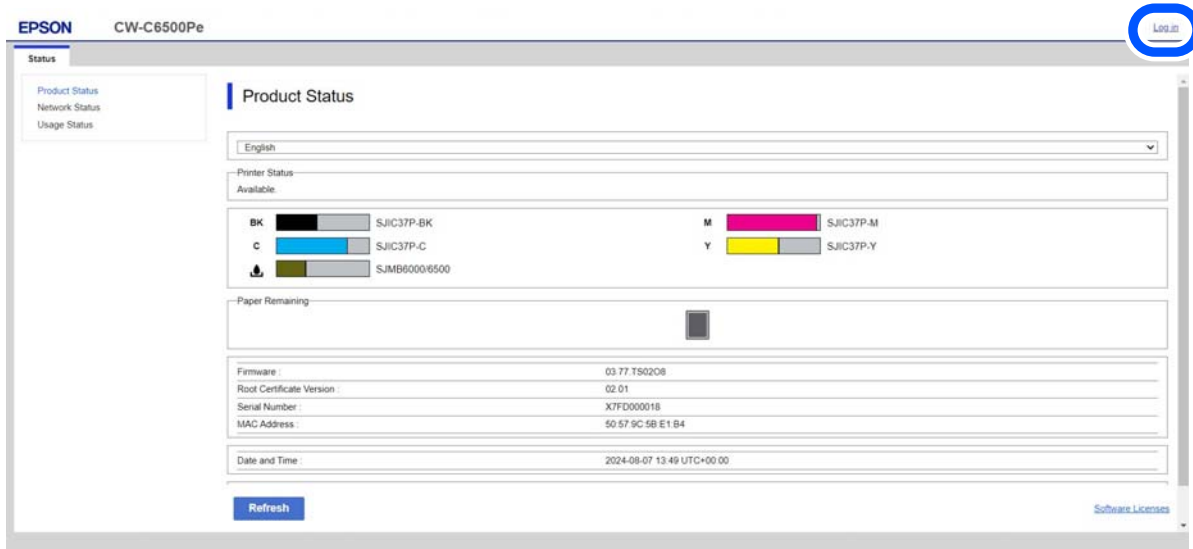

### 2 Check the [Software Cloud Status] field on the [Status] screen.

- If the message "Connection test was successful" is displayed, the printer is connected.

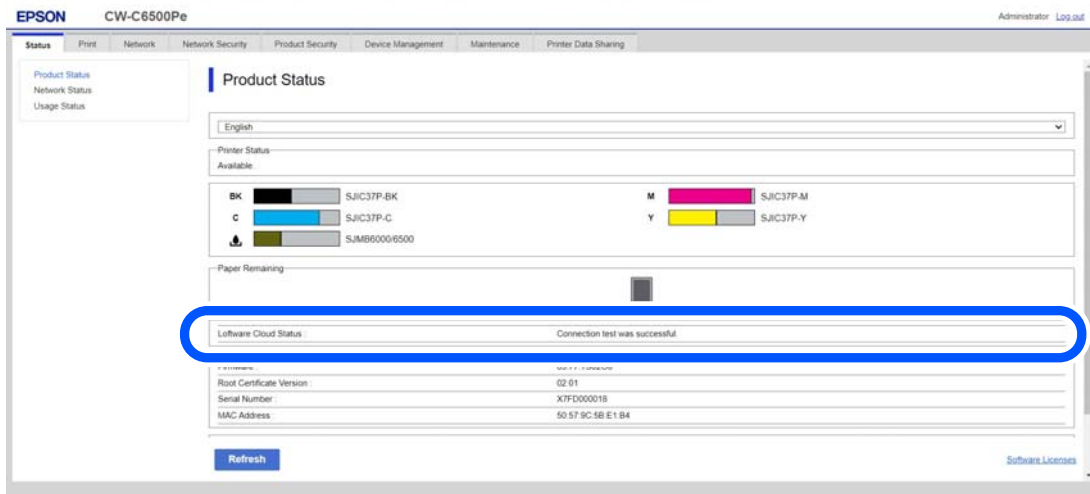

- If an error number is displayed, the printer is not connected.  
Check the solutions listed in "[Error Number List](#)" on page 266.  
In this example, the error number is 910005.

The screenshot displays the Epson CW-C6500Pe printer's status page. The page is titled "Product Status" and includes a navigation menu with options like "Status", "Print", "Network", "Network Security", "Product Security", "Device Management", "Maintenance", and "Printer Data Sharing". The printer status is shown as "Available". Ink levels for BK, C, M, and Y are displayed with corresponding color bars and labels: BK (SJC37P-BK), C (SJC37P-C), M (SJC37P-M), and Y (SJC37P-Y). A "Paper Remaining" indicator is also present. A blue circle highlights the "Software Cloud Status" section, which displays the error message: "Error(910005) The Proxy Server is unavailable". Other details include Firmware (03.77.TS0208), Root Certificate Version (02.01), Serial Number (X7FD000018), and MAC Address (50:57:9C:5B:E1:B4). A "Refresh" button is located at the bottom left, and "Software Licenses" is at the bottom right.

Software Cloud Status :	Error(910005) The Proxy Server is unavailable
Firmware :	03.77.TS0208
Root Certificate Version :	02.01
Serial Number :	X7FD000018
MAC Address :	50:57:9C:5B:E1:B4

## Checking from Epson Device Admin

### 1 Start Epson Device Admin.



For details on Epson Device Admin, see ["Epson Device Admin" on page 245](#).

The default administrator password is the string on the password label on the rear side of the printer.

### 2 Check [Loftware Cloud] - [Status] on the device details screen.

- If "Enabled" is displayed, the printer is connected.

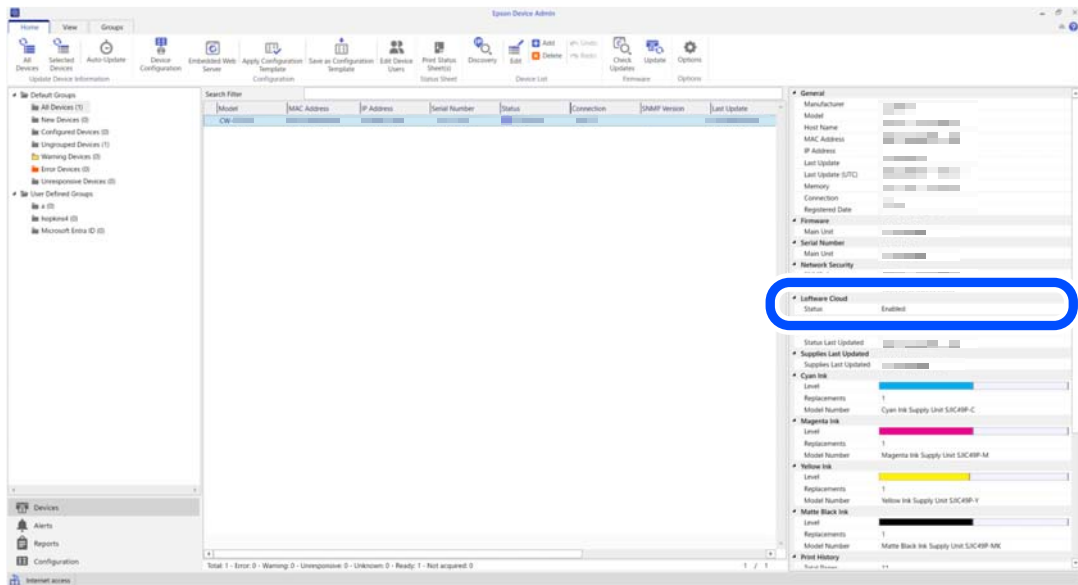

- If "Disabled" or an error number is displayed, the printer registration has failed. Check the solutions listed in ["Error Number List" on page 266](#). In this example, the error number is 910005.

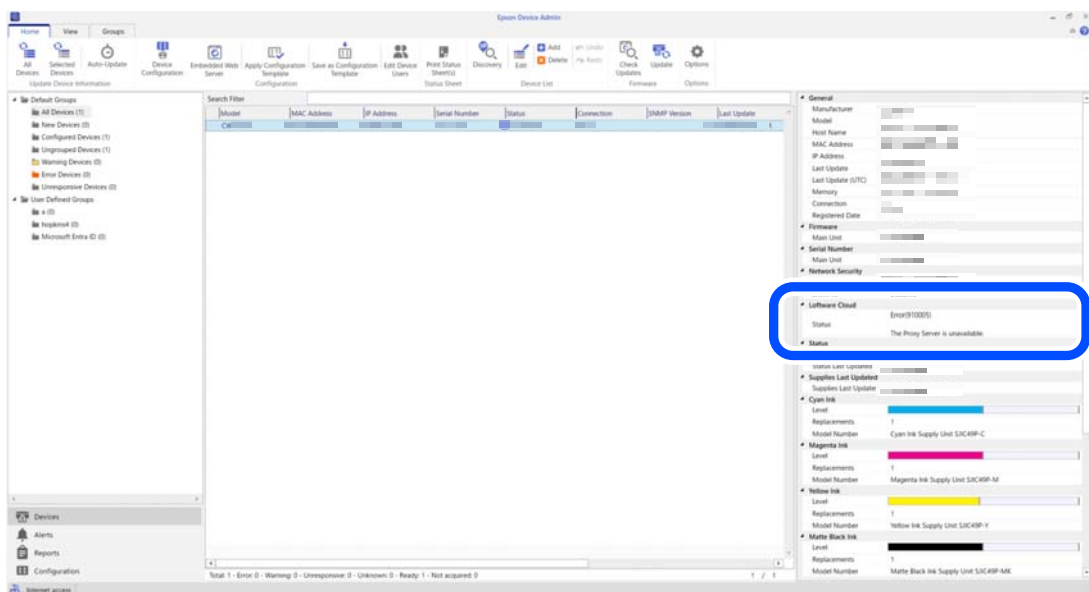

## Error Number List

Check the error number regarding Loftware Cloud and take action according to the number.

Error Number	Descriptions
910002, 910010, 910011	Internet or service is not available. Check the LAN cable connection and network settings and try again later.
910003	DNS server is not available. Check if the DNS server settings are correct and try again later.
910004	DNS cannot resolve the domain name. Check your Internet connection and domain name and try again later.
910005	Connection to the proxy server has failed. Check if the proxy server settings are correct and try again later.
910006	The connection to the proxy server has been disconnected. Check the HTTPS port permission settings or proxy authentication and try again later.
910007	The Loftware Cloud server is failing to authenticate the printer because the printer's date or time is not set correctly. Match the printer's date and time to the server's date and time. The date and time can be set on the control panel, in Web Config, or in Epson Device Admin.
910008, 910009	Loftware Cloud service is not available. Try again after a while. If the problem persists, please contact Loftware Cloud support.
910012	The Loftware Cloud server has failed to authenticate the printer. Re-register the printer after a while. If the problem persists, please contact Loftware Cloud support with the error ID and message shown on the screen.

## Troubleshooting

If you failed to connect your printer to the server as a cloud printer, check the following.

**1 Check if the printer's network settings are correct. The following network-related items must be configured correctly. In particular, make sure that the DNS server and proxy server settings are correct.**

- IP Address
- Subnet Mask
- Default Gateway
- Primary DNS Server
- Secondary DNS Server
- Proxy Server
- Proxy Server Port Number

**2 Make sure that the printer serial number entered into [Cloud Printer Settings] - [Serial Number] in the Software Control Center does not contain spaces or line feed codes.**

If you copied the printer serial number from Web Config or other source when registering the cloud printer, you may have inadvertently included spaces or line feed codes and unintentionally entered an incorrect serial number that includes them.

## Spot Color Settings

[Spot Color Settings] allows you to change a specified color to another specified color. First create the color conversion setting file, then when printing, specify the setting file to print with the color conversion applied. Follow the procedure below to create the color conversion setting file.



The printer converts all the portions of print data that use the specified RGB settings into the target color. If unintended portions are converted into the target color, slightly change the RGB settings of the portions to make them not to be converted.

### Creating Spot Color Setting File

#### 1 Check the RGB settings of a color you want to convert into another color in the print data.

The check method for Microsoft Paint is explained here as an example.

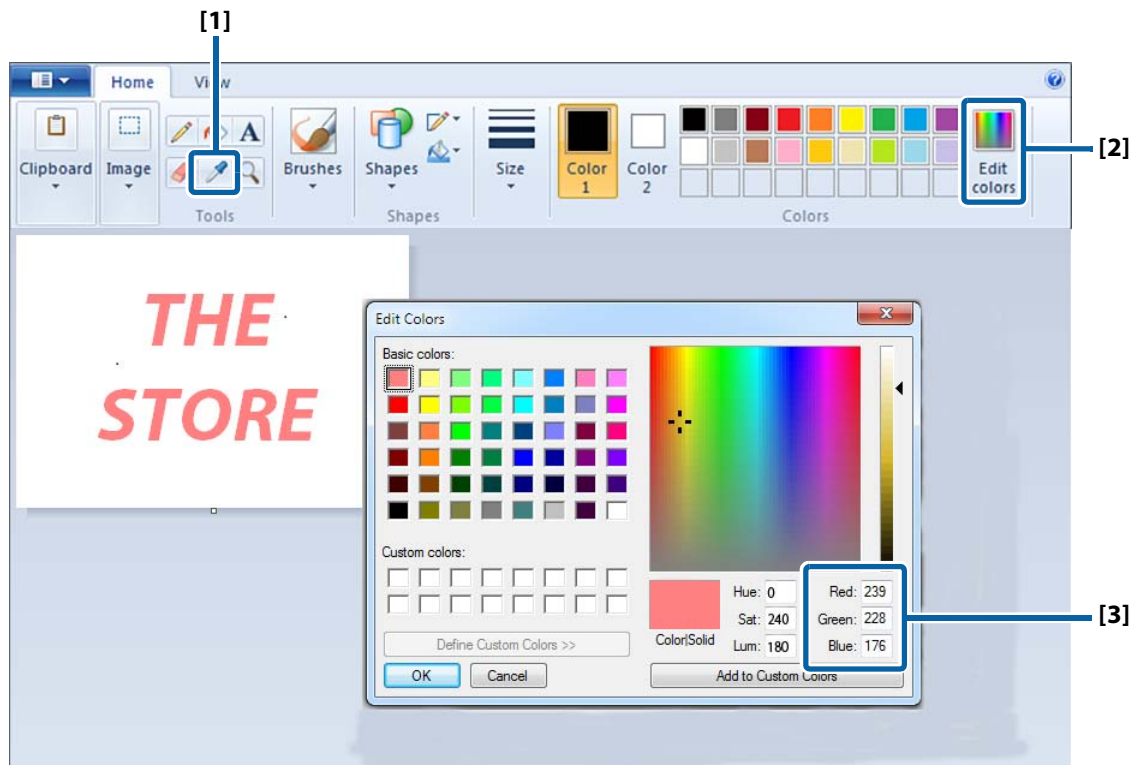

[1] Select the Picker tool, and then click on a color you want to check.

[2] Click the [Edit Colors] button to display the Edit Colors window.

[3] Check the RGB settings of the selected color, and write them down.



The method to check the RGB settings differs by graphic software to another. See the manual or help of the software you use.

## 2 Determine RGB settings of a target color.



When determining the desired color, we recommend using the "Color Tone Matching Assistant" which can be downloaded from the following website.

For customers in North America, go to the following web site:

<https://www.epson.com/support/>

For customers in other countries and regions, go to the following web site:

<https://epson.sn>

Color Tone Matching Assistant lets you enter the RGB settings of the original color, creates some sample colors by slightly changing the original RGB settings, and then lets you print the samples. You can choose a target color and know its RGB settings on the printout. For more details, see "Color Tone Matching Assistant User's Guide".

Color Tone Matching Assistant

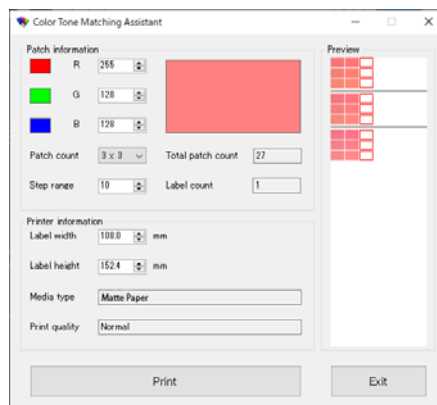

Example of the Sample Colors

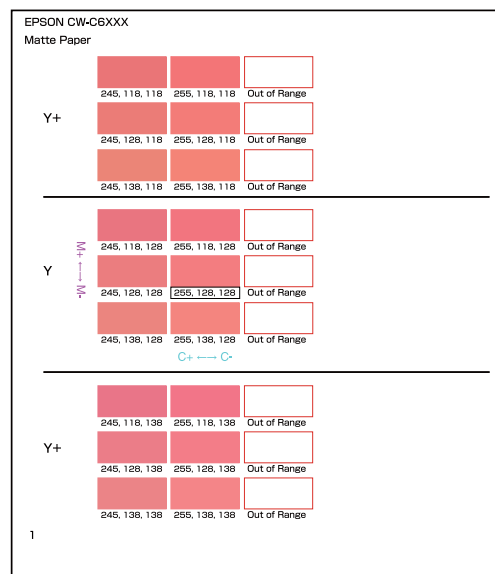

If you have set font replacement, the sample pattern in the Color Tone Matching Assistant may not be printed normally. Unset font replacement and then print.

## 3 Start PrinterSetting.

("How to Start PrinterSetting" on page 188)

- 4 Select [Store data in the printer].
- 5 Click [Create] button in the [Spot color table] field.

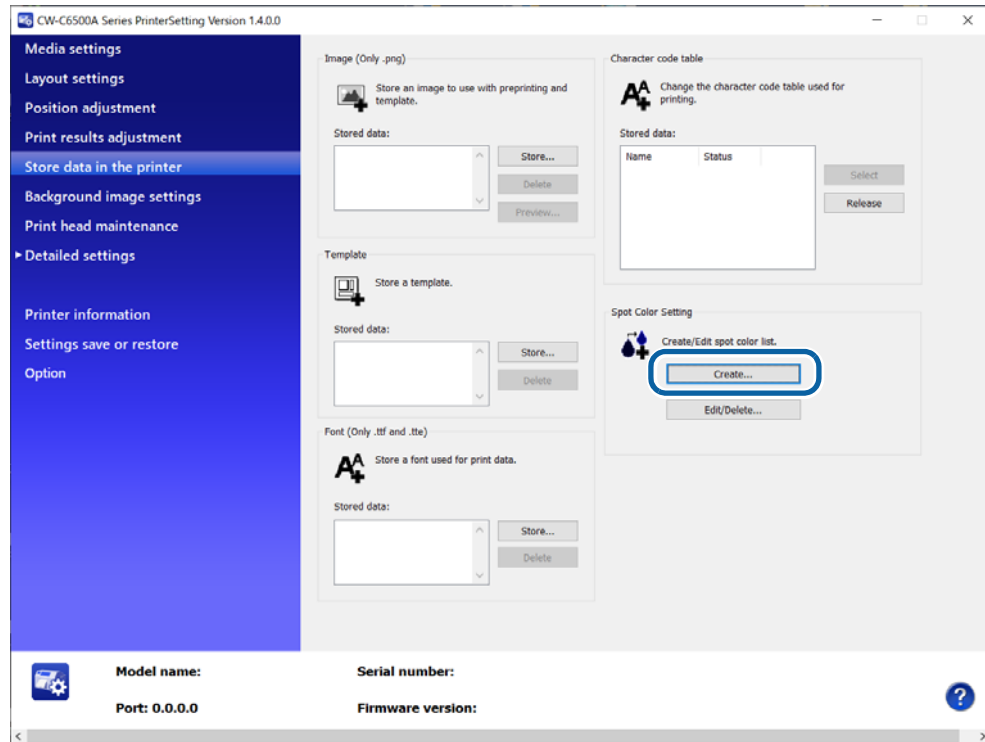

- 6 Enter the original RGB settings and the target RGB settings.

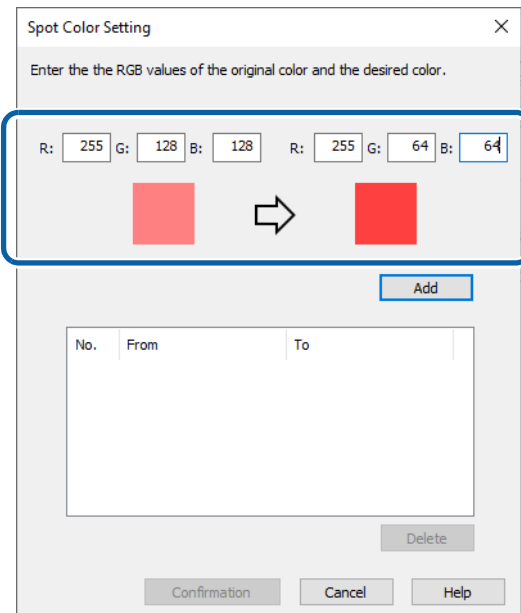

- 7 Click [Add].**  
The specified pair of RGB settings will be added in the box.

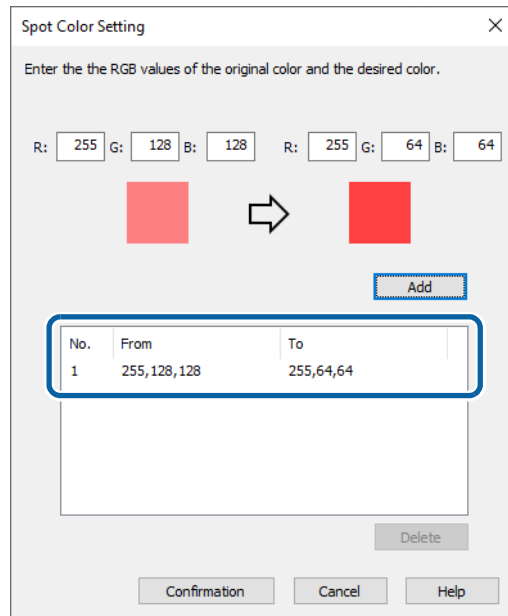

- 8 Click [Confirmation].**  
A window to enter a name for the spot color setting is displayed.

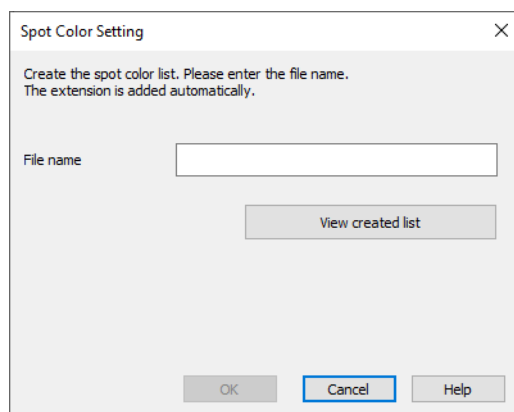

- 9 Enter a name for the setting file, then click [OK].**

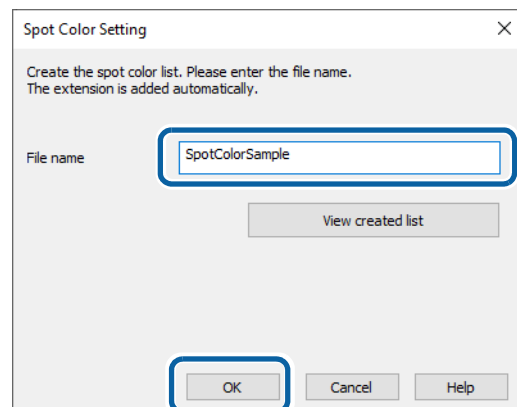

- 10** When you select [OK] on a successfully saved dialog box, the [Created spot color list] window appears.

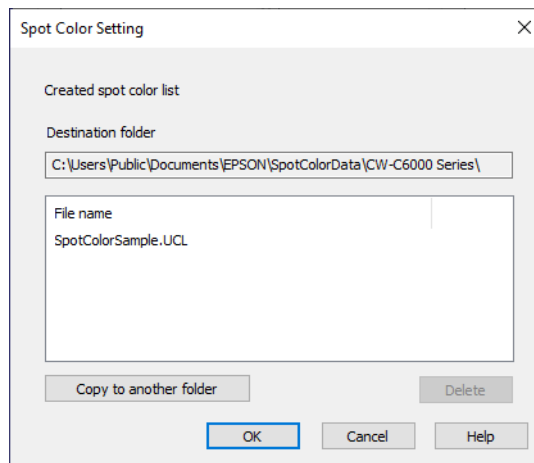

If you want to copy the file to another location, click [Copy to another folder].

Creating spot color setting file is now complete.

## Printing using the Spot Color Setting File

- 1 Open the printer driver window.
- 2 Select [Spot Color Settings] on the [General] window.

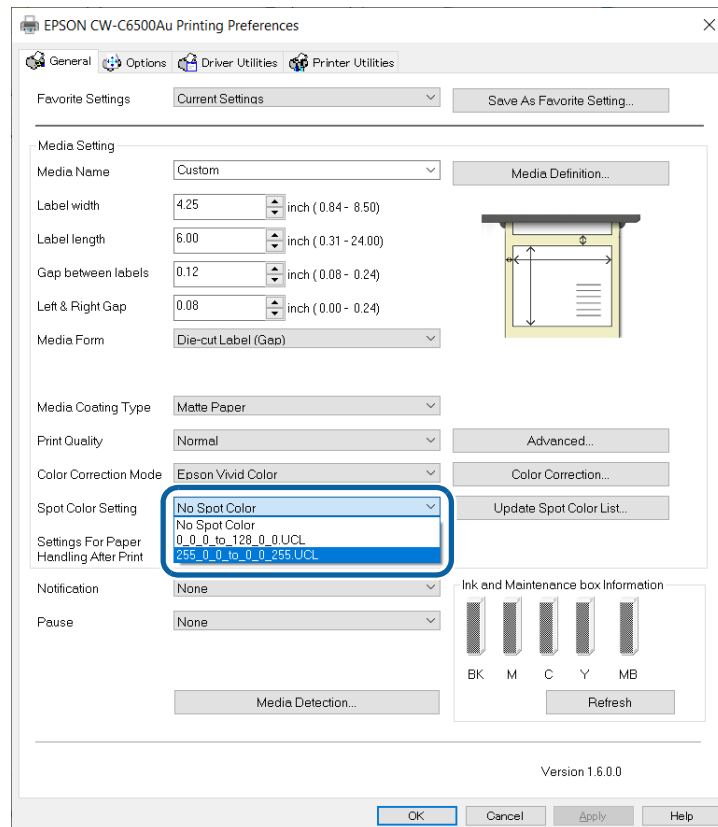

- 3 From the pull-down menu, select a spot color setting file you want to use.



To change the folder to view, click [Update Spot Color List] and change the folder.

- 4 **Print the file.**  
The printer driver prints the file after performing the color conversion as specified in the setting file.

Printing using the spot color setting file is now complete.

## Color Correction

There are the following three methods for color correction.

- Setting on the printer
- Setting using OS
- Setting using an application software

According to which method you use, set [Color Correction Mode] of the printer driver as follows.

- Setting on the printer: Set to [Epson Vivid Color], [Epson Preferred Color]
- Setting using OS: Set to [ICM] for Windows, Set to [ColorSync] for Mac
- Setting using an application software: Set to [None]

### Relationship Between Driver Settings, Color Correction Methods, and Spot Color Settings

The color of the print result varies depending on the menu settings on the driver.

There are two menus on the driver for changing the color of the print result: [Color Correction] and [Spot Color Setting].

[Color Correction] changes the overall color, and there are color correction engines in the printer, in the OS, and in certain applications. The setting selected in [Color Correction] in the printer driver specifies which color correction engine to use and also passes input parameters to each color correction engine.

Only one setting can be selected for [Color Correction Method]. Therefore, no color correction engine in the printer, in the OS, or in a particular application will be used at the same time, but only one of them will be used.

[Spot Color Setting] replaces the specified specific color (= the original color) with another color (= the target color), and there is a color replacement engine in the printer or driver.

When [Color Correction] is set to [Epson Vivid Color] or [Epson Preferred Color], which uses the printer's internal color correction engine, and [Color Correction] is set to [ICM], which uses the OS's internal color correction engine, color correction can be performed in combination with [Spot Color Setting].

When [Color Correction] is set to [None], color correction cannot be performed in combination with [Spot Color Setting].

This is because if the application color correction is performed first, the RGB values before conversion specified in [Spot Color Setting] will be changed, and the printer driver will not be able to find the part to be converted.

Setting on the driver		By What is the Color Correction Performed?
Menu	Selection	
Color Correction	Epson vivid color	Color correction engine in the printer
	Epson Preferred Color	Color correction engine in the printer
	ICM	Color correction engine in the OS
	None	Assumption that color correction is performed by an application software
Spot Color Setting	No Spot Color	None
	File name of the spot color list	Color replacement engine for spot colors in the printer or driver

### Color Correction Method Options by Model

ColorWorks series printers have different internal color correction methods supported by each model. Selecting the same color correction method may produce similar shades\*.

\* The same color shade will not be achieved because different models use different inks.

	Color Correction Method Options provided by Printer		
	EPSON Vivid Color	Epson Preferred Color	Epson Standard
CW-C8000 Series	✓	✓ (default)	✓
TM-C7500 Series	--	✓ (default)	✓
CW-C4000 Series	✓	✓ (default)	--
CW-C6000/C6500 Series	✓	✓ (default)	--
CW-D6000/D6500 Series	✓	✓ (default)	--
TM-C3500 Series	--	✓ (default)	✓

✓: supported

--: Not supported

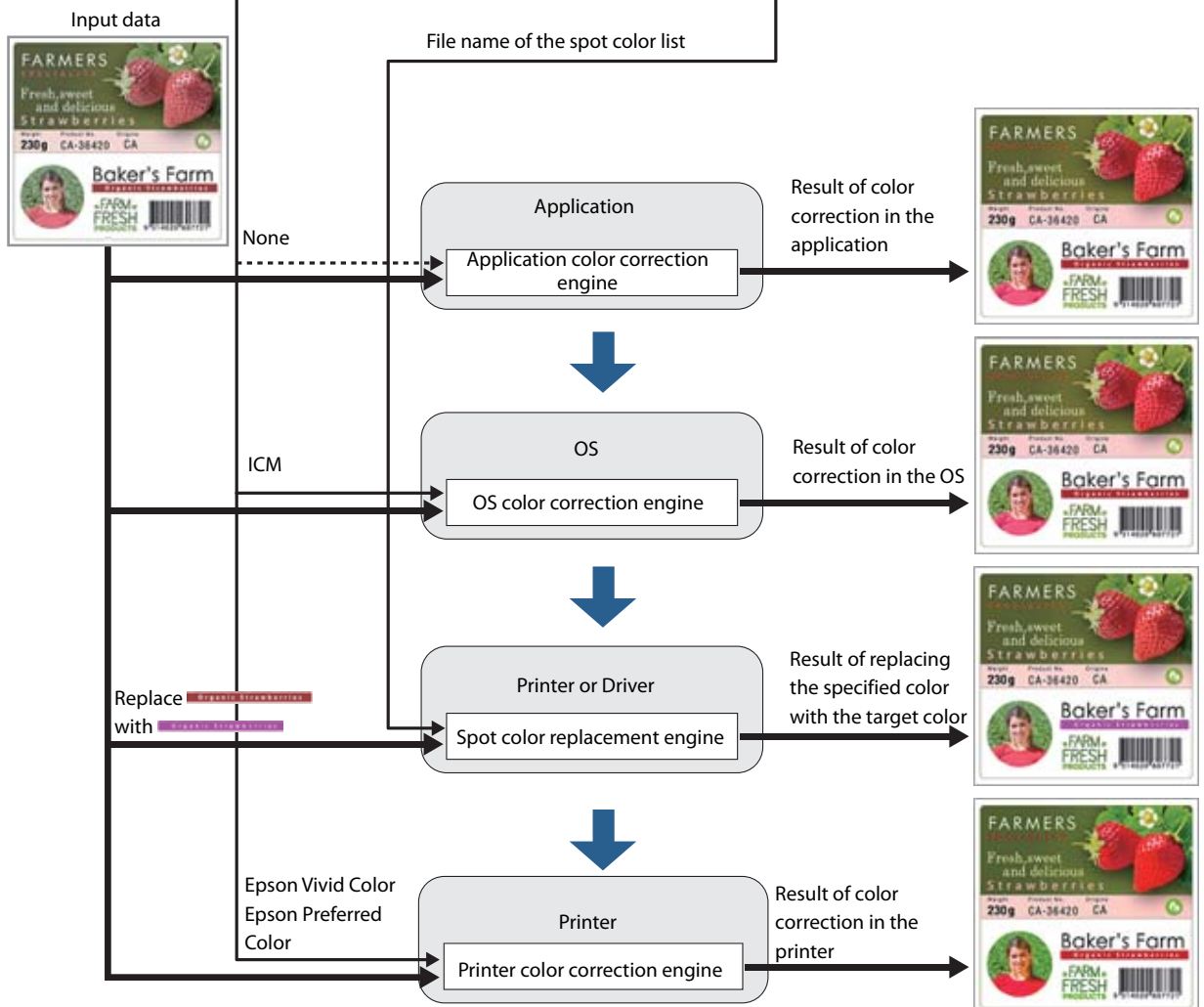
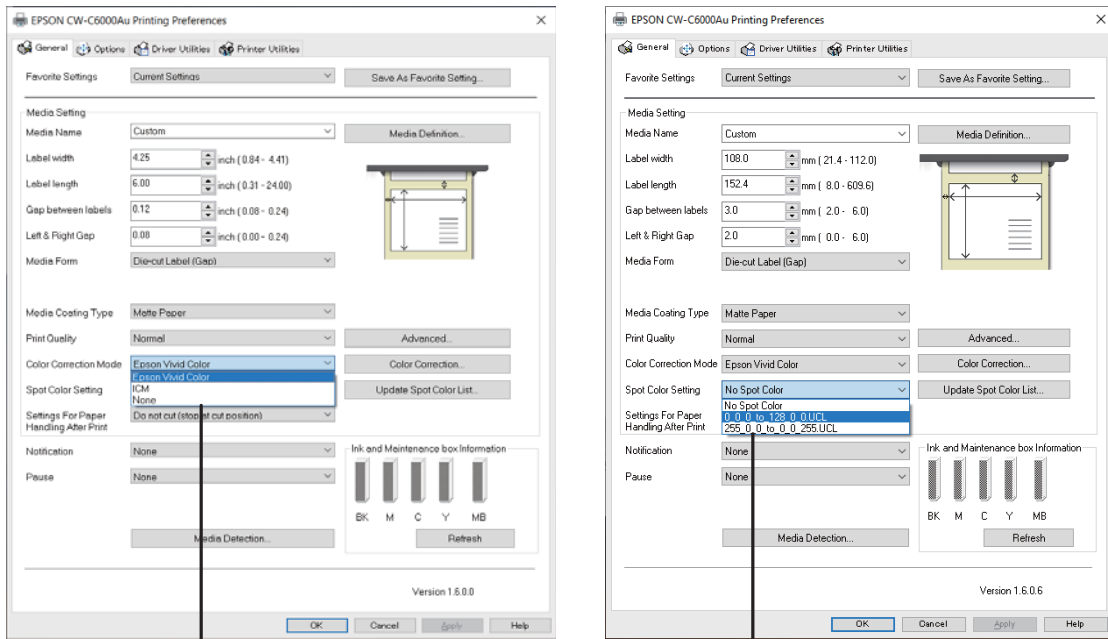

**CAUTION** The image data is a representation of the concept of color correction, and is not the actual data before and after color correction.

## Setting on the Printer

### Epson Vivid Color

“Epson Vivid Color” conforms to the Adobe RGB color space for images, which has a wider color reproduction range than sRGB, but in order to bring the colors of the print result closer to the monitor, you need to prepare a monitor that is compatible with Adobe RGB.

### Epson Preferred Color

“Epson Preferred Color” conforms to the sRGB color space for images. The color reproduction range is narrower than Adobe RGB, but the colors of printed results are close to those shown on common monitors.

### Correction Method

When you click the [Color Correction] button with [Epson Vivid Color] selected, the Color Correction window appears.

Change the color settings comparing the [Original Picture] image and the [Preview] image.

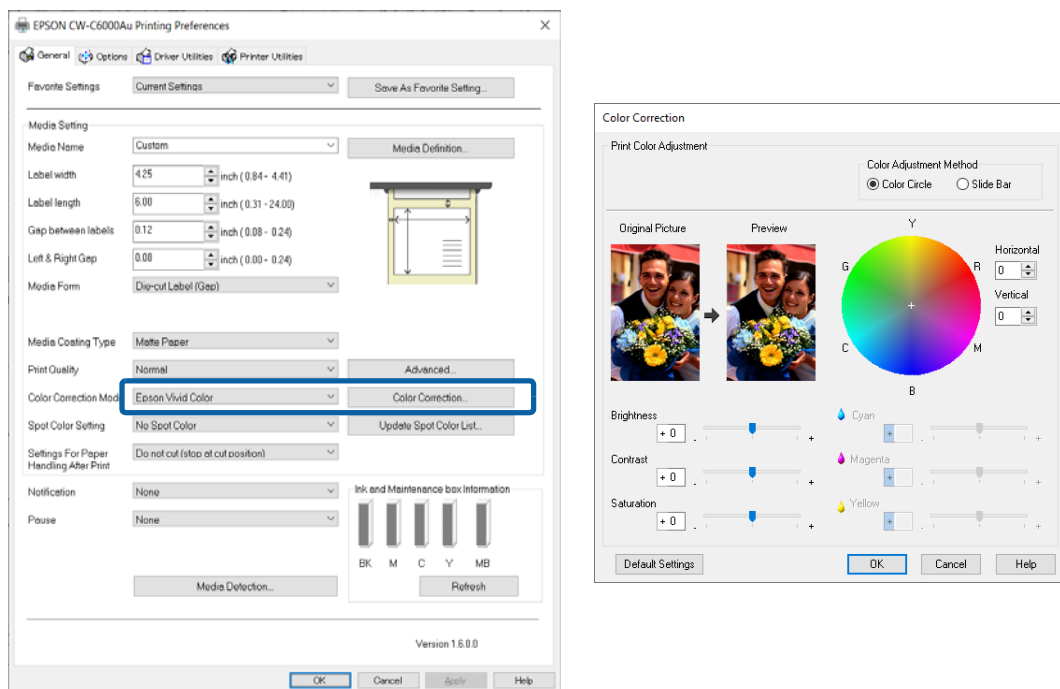

Item	Description
Brightness	Lets you adjust brightness of the entire image.
Contrast	Adjust the contrast of the entire image. When the contrast is increased, bright portions become more bright, and dark portions become more dark. When the contrast is decreased, difference between light and dark is reduced.

Item		Description
Saturation		Lets you adjust saturation (vividness) of the entire image. When the saturation is increased, the feel of the vividness of the image is increased. The more the saturation is decreased, the more the image becomes achromatic closing to gray.
Color Adjustment Method	Color Circle	Click on the circle to adjust the color. You can also adjust color by entering values in the [Horizontal and [Vertical] boxes.
	Slide Bar	You can move the Cyan, Magenta, and Yellow slide bars to adjust color.

## Setting using OS

### ICM

ICM (Image Color Management) is a Windows color control function to match apparent color between different devices such as a monitor and a printer. Apparent color on the monitor and on the printout is matched based on ICC profiles.

An ICC profile is a file that describes characteristics of the device such as a monitor and a printer according to ICC (International Color Consortium) standards.

However, since the color space of a four-color printer is narrow comparing to that of a monitor, it is impossible to accurately match colors on the monitor with printouts.

When you click the [Color Correction] button with [ICM] selected, the ICM window appears.

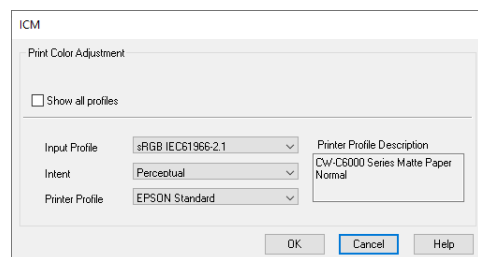
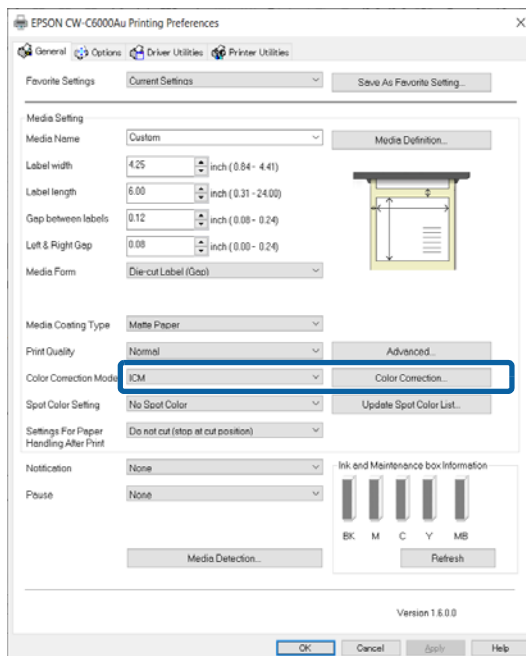

Item		Description
Show all profiles		<p>When the printer driver is installed, ICC profiles for Epson genuine paper are also installed. The ICC profiles include all combinations of [Media Coating Type] and [Print Quality] for each Epson paper.</p> <p>Since the check box for this item is not checked by default, the [Input Profile] setting is fixed to [sRGB IEC61966-2-1], and the [Printer Profile] setting is fixed to [EPSON Standard]. With the default settings, one of the ICC profiles for Epson paper is automatically selected according to the [Media Coating Type] and [Print Quality] settings.</p> <p>Select this check box when using paper other than Epson genuine paper and you have installed an ICC profile for the paper.</p> <p>When the check box is selected, the pull-down menu of [Input Profile] and [Printer Profile] shows all profiles installed on the system. Select the target ICC profile from the [Printer Profile] menu.</p>
Input Profile		<p>Select a profile for a display device.</p> <p>Normally, only "sRGB IEC61966-2-1", which is the default of Windows OS, is displayed.</p>
Intent	Saturation	Color is converted keeping the saturation.
	Perceptual	Color is converted keeping natural-looking image. Select this when color space of the image is wide.
	Relative Colorimetric	Color is converted so that chromatic coordinate between the original data and the print data matches, and the white point (color temperature) also matches between them. This method is used a lot for color matching.
	Absolute Colorimetric	Color is converted assigning both the original and print data to absolute chromatic coordinate. The white point (color temperature) of the original and print data is not corrected. Use this method to print an image that has a specific color such as a corporate logo.
Printer Profile		<p>Select a printer profile that matches the media you use. Normally, only [EPSON Standard] is displayed. [EPSON Standard] automatically selects an ICC profile for Epson genuine paper that matches the [Media Coating Type] and [Print Quality] settings on the printer driver.</p>

## ColorSync

“ColorSync” is a Color Matching engine on macOS. That is similar to ICM on Windows.

The following describes how to set an ICC profile using ColorSync taking Adobe Photoshop (hereafter, Photoshop) and other popular apps as examples.

### The case of the printing from Photoshop

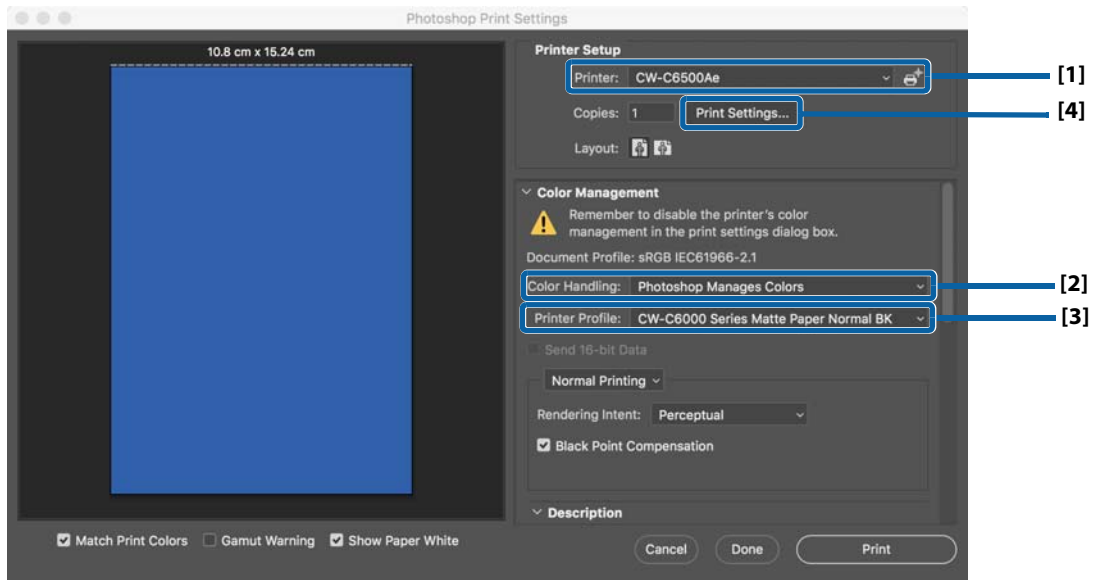

- 1 Select the printer queue to [Printer] menu.
- 2 Select [Photoshop Managed Color] to [Color Handling] menu.  
You cannot get the printing output with the color matching, if you select [Printer Managed Colors].
- 3 Select the suitable output ICC profile to [Printer Profile] menu.
- 4 Click [Print Settings], then select the print settings of the printer driver.  
The controls on [Color Matching] and [Color Options] are fixed, and you cannot change those.

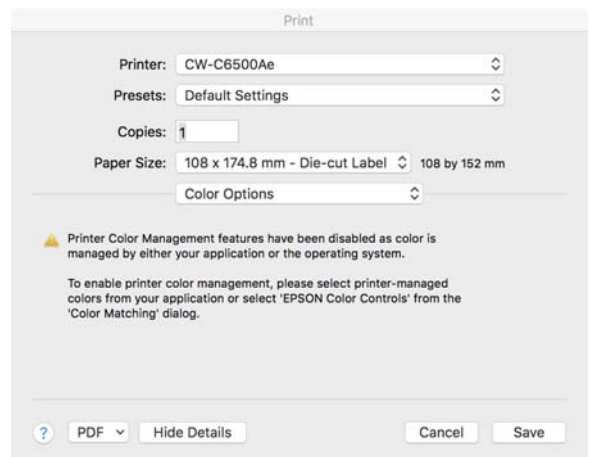
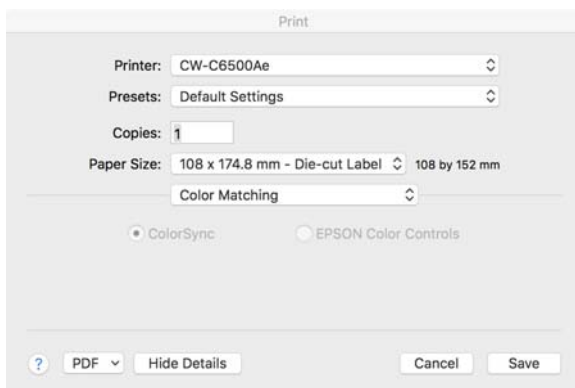

- 5 Select other print settings of Photoshop print window.
- 6 Click [Print] button.

### The case of the printing from Preview

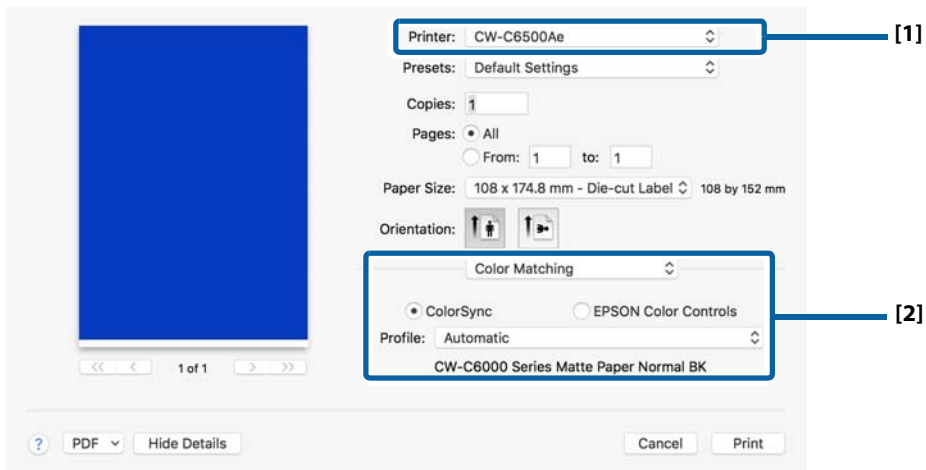

- 1 Select the printer queue to [Printer] menu.
- 2 Select [ColorSync] on [Color Matching] pane, then select the suitable output ICC profile to [Profile] menu.

The suitable output ICC profile provided by Epson is selected automatically, when you select [Automatic]. Select [Other Profiles] to open the [Select ColorSync Profile] window. You can select other output ICC profile by that window.

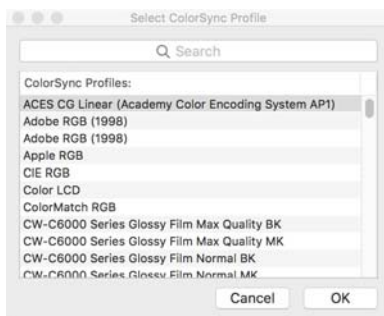

- 3 Select other print settings of the printer driver.
- 4 Click [Print] button.

## The case of the printing from Acrobat Reader



### Notes on using ColorSync

- The PDF data must be RGB data. CMYK data cannot be corrected properly.
- If a source profile (input profile) has not been embedded in the print data, “sRGB IEC61966-2.1” is automatically applied as the source profile.
- The rendering intent is fixed to “Perceptual”.

**1** Select the printer in [Printer], and then click [Printer...] at the bottom of the screen.

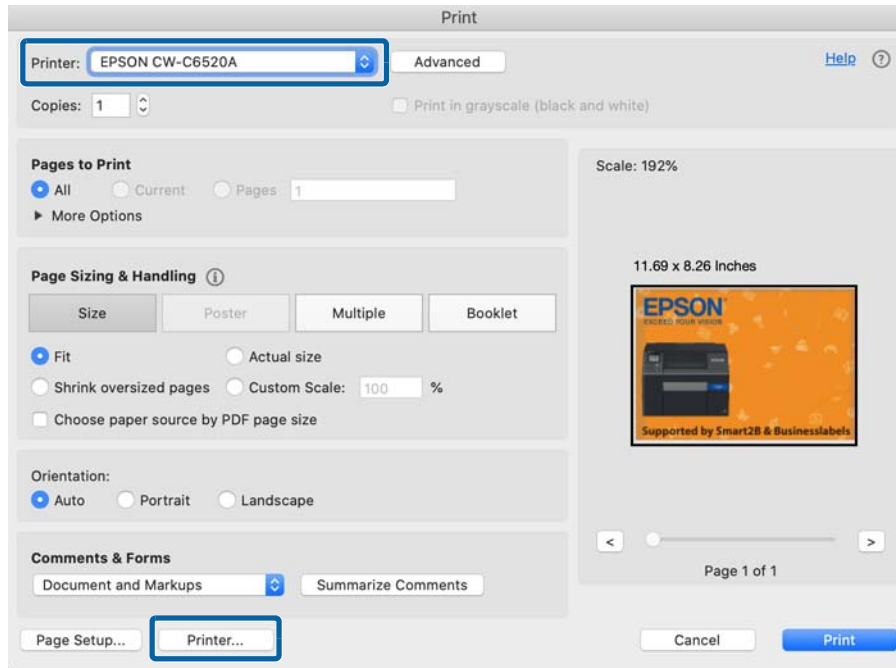

## 2 Select [ColorSync] as the [Color Matching] option, and then select a proper ICC profile in [Profile].

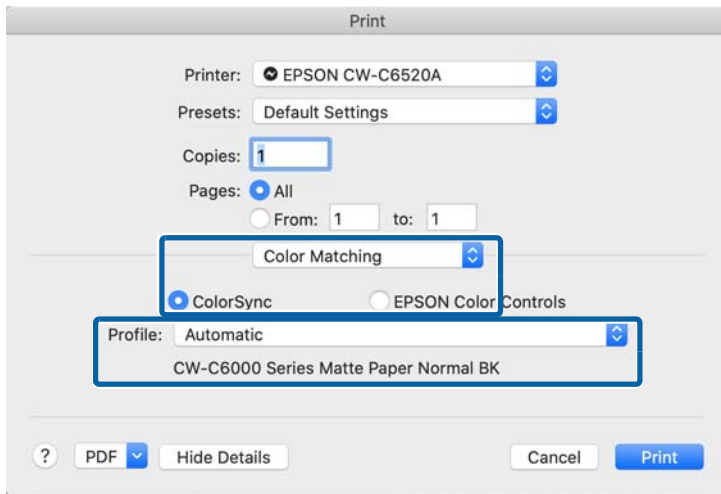

The default profile setting is [Automatic] which automatically selects an ICC profile provided by Epson.

Select [Other Profiles...] to display the ColorSync profile selection screen and select a target ICC profile by yourself.

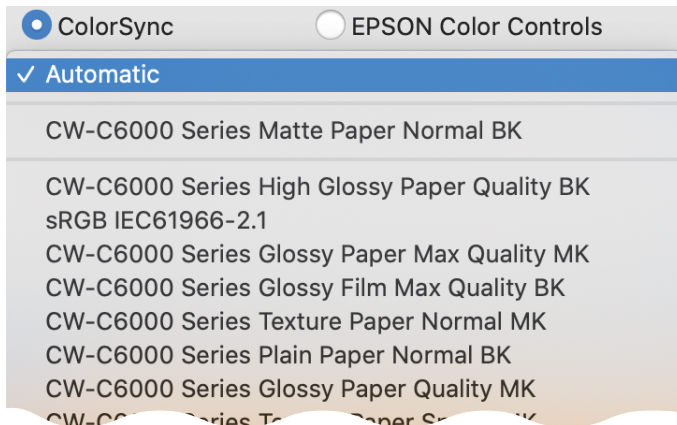

## 3 Select other print settings.

## 4 Click [Advanced].

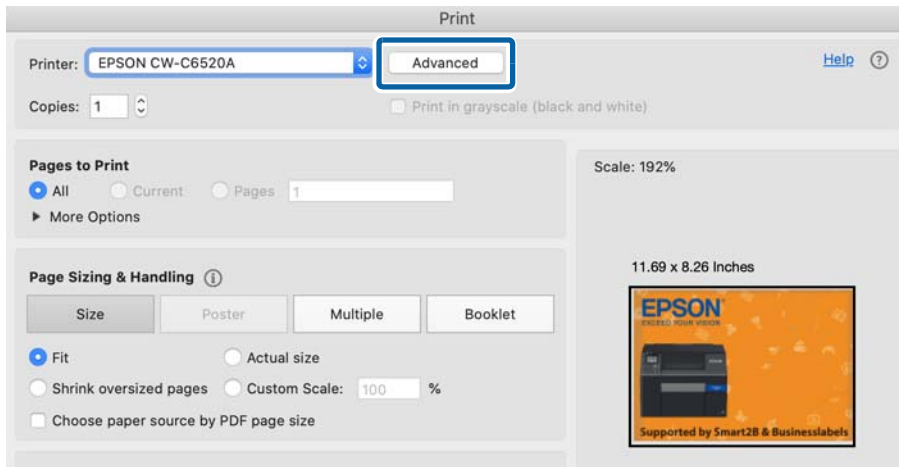

## 5 Select the checkbox for [Print As Image], and then click [OK].

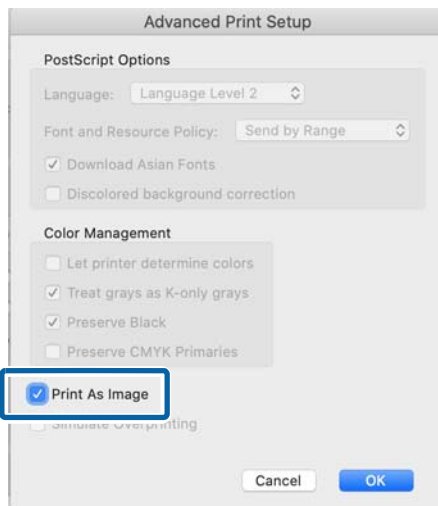

## 6 On the [Print] screen, click the [Print] button.

## Creating an ICC Profile

### What is ICC Profile?

An ICC profile is a file (file extension is .icc) that describes information for controlling colors according to the International Color Consortium (ICC) definition. Printout colors change significantly depending on the paper type and print mode.

CW-C6500/6000 Series offer you the ICC profiles for each Epson genuine paper covering all combinations of paper types and print quality settings (print mode). The ICC profiles are stored in the folder shown below when the Windows printer driver is installed.

C:\Windows\System32\spool\drivers\color

If you use paper other than Epson genuine paper, you need to prepare an ICC profile for the paper by yourself.

### ICC Profiles provided for CW-C6500/6000 Series

Media Name	Print Quality	Ink Type	ICC Profile Name
Plain Paper	Max Speed	Gloss	CW-C6000Series_PlainPaper_MaxSpeed.icc
		Matte	CW-C6000Series_PlainPaper_MaxSpeed_MK.icc
	Speed	Gloss	CW-C6000Series_PlainPaper_Speed.icc
		Matte	CW-C6000Series_PlainPaper_Speed_MK.icc
	Normal	Gloss	CW-C6000Series_PlainPaper_Normal.icc
		Matte	CW-C6000Series_PlainPaper_Normal_MK.icc
	Quality	Gloss	CW-C6000Series_PlainPaper_Quality.icc
		Matte	CW-C6000Series_PlainPaper_Quality_MK.icc
Matte Paper	Max Speed	Gloss	CW-C6000Series_MattePaper_MaxSpeed.icc
		Matte	CW-C6000Series_MattePaper_MaxSpeed_MK.icc
	Speed	Gloss	CW-C6000Series_MattePaper_Speed.icc
		Matte	CW-C6000Series_MattePaper_Speed_MK.icc
	Normal	Gloss	CW-C6000Series_MattePaper_Normal.icc
		Matte	CW-C6000Series_MattePaper_Normal_MK.icc
	Quality	Gloss	CW-C6000Series_MattePaper_Quality.icc
		Matte	CW-C6000Series_MattePaper_Quality_MK.icc

Media Name	Print Quality	Ink Type	ICC Profile Name
Synthetic	Max Speed	Gloss	CW-C6000Series_Synthetic_MaxSpeed.icc
		Matte	CW-C6000Series_Synthetic_MaxSpeed_MK.icc
	Speed	Gloss	CW-C6000Series_Synthetic_Speed.icc
		Matte	CW-C6000Series_Synthetic_Speed_MK.icc
	Normal	Gloss	CW-C6000Series_Synthetic_Normal.icc
		Matte	CW-C6000Series_Synthetic_Normal_MK.icc
	Quality	Gloss	CW-C6000Series_Synthetic_Quality.icc
		Matte	CW-C6000Series_Synthetic_Quality_MK.icc
Texture Paper	Max Speed	Gloss	CW-C6000Series_TexturePaper_MaxSpeed.icc
		Matte	CW-C6000Series_TexturePaper_MaxSpeed_MK.icc
	Speed	Gloss	CW-C6000Series_TexturePaper_Speed.icc
		Matte	CW-C6000Series_TexturePaper_Speed_MK.icc
	Normal	Gloss	CW-C6000Series_TexturePaper_Normal.icc
		Matte	CW-C6000Series_TexturePaper_Normal_MK.icc
	Quality	Gloss	CW-C6000Series_TexturePaper_Quality.icc
		Matte	CW-C6000Series_TexturePaper_Quality_MK.icc
Glossy Paper	Normal	Gloss	CW-C6000Series_GlossyPaper_Normal.icc
		Matte	CW-C6000Series_GlossyPaper_Normal_MK.icc
	Quality	Gloss	CW-C6000Series_GlossyPaper_Quality.icc
		Matte	CW-C6000Series_GlossyPaper_Quality_MK.icc
	Max Quality	Gloss	CW-C6000Series_GlossyPaper_MaxQuality.icc
		Matte	CW-C6000Series_GlossyPaper_MaxQuality_MK.icc
Glossy Film	Normal	Gloss	CW-C6000Series_GlossyFilm_Normal.icc
		Matte	CW-C6000Series_GlossyFilm_Normal_MK.icc
	Quality	Gloss	CW-C6000Series_GlossyFilm_Quality.icc
		Matte	CW-C6000Series_GlossyFilm_Quality_MK.icc
	Max Quality	Gloss	CW-C6000Series_GlossyFilm_MaxQuality.icc
		Matte	CW-C6000Series_GlossyFilm_MaxQuality_MK.icc

Media Name	Print Quality	Ink Type	ICC Profile Name
High Glossy Paper	Normal	Gloss	CW-C6000Series_HighGlossyPaper_Normal.icc
		Matte	CW-C6000Series_HighGlossyPaper_Normal_MK.icc
	Quality	Gloss	CW-C6000Series_HighGlossyPaper_Quality.icc
		Matte	CW-C6000Series_HighGlossyPaper_Quality_MK.icc
	Max Quality	Gloss	CW-C6000Series_HighGlossyPaper_MaxQuality.icc
		Matte	CW-C6000Series_HighGlossyPaper_MaxQuality_MK.icc



ICC profiles made by X-rite solutions are included.

## Procedure for Creating an ICC Profile

When using paper other than Epson genuine paper, acquire an ICC profile of the paper provided by the paper manufacturer, or create an ICC profile for the paper by yourself.

To create an ICC profile, you need a colorimeter and a software program that generates an ICC profile.

Example:

- X-Rite, Incorporated (<https://xritephoto.com/>)
  - i1iO2 (colorimeter), i1Profiler (software program to generate an ICC profile)
- Datacolor company (<https://www.datacolor.com/>)
  - SpyderPrint (print calibration tool)

Since detailed procedure varies depending on the device and software used, the following describes the general procedure. See the manual that came with the device and software for more details.

- 1 Start a software program that generates an ICC profile, and then print color patches for measurement on the paper you want to use.**
- 2 Measure the printed color patches with a colorimeter.**
- 3 Using the software program, generate an ICC profile according to the measured results.**



- Create a profile that is compatible with ICC version 2.
- Use ASCII character strings for ICC profile names.

For more details, visit the following URL.

<https://color.org>

## None

The [Color Correction] button is disabled when [Color Correction Mode] is set to [None].

Select [None] only when setting color correction on an application software. For instructions on how to set color correction on the software, see its manual or help.

## Printing from the First Label (Auto cutter model only)

If the [Media Detect] setting has been set to [Gap], you cannot print on the first label (printed from the second label) at the first time printing after loading paper.

However, for the auto cutter model, even when [Gap] is selected as [Media Detect], you can prevent missing of the first label by following the procedure below.



- When you perform the following and print, auto cut is disabled.
- If there is a difference between a label actually used and the settings on the printer driver, the print quality may decline.



- For the peeler model, there is no measure to print from the first label.
- For the auto cutter model, this procedure is not necessary if [Media Detect] is [Black Mark] or [None].

- 1 Cut off the backing paper from 2 mm (0.08 inches) away from the top edge of the first label.**

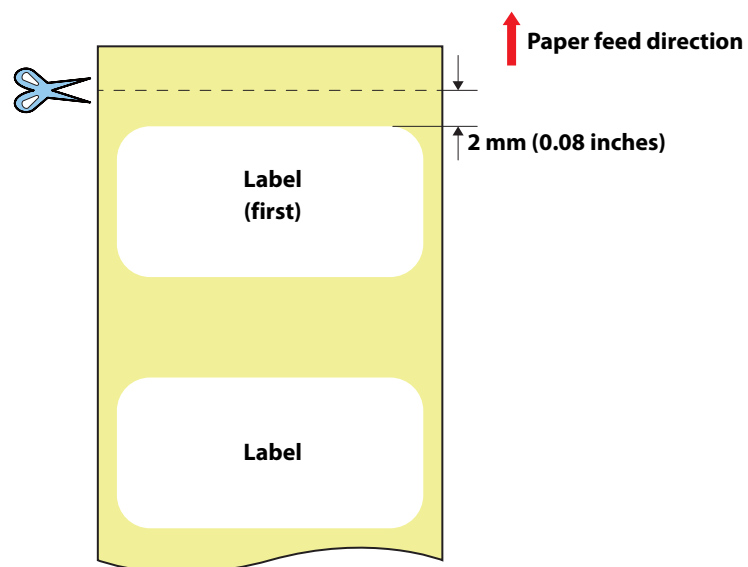

- 2 On the operation panel of the printer, select [Not Feed] from [Actions when Replacing Media].**

[Menu] - [General Settings] - [Printer Settings] - [Print Options] - [Actions when Replacing Media] - [Not Feed]

The default setting is [Feed] (for peeler model) or [Feed without Cut] (for auto cutter model).

- 3 Specify a length of the label, and a gap between labels.**

("Media Settings" on page 49)

- 4 Load paper, and then print.**

For the paper loading procedure, see "Opening the Paper Cover" on page 50.

## Setting Label Size and Paper Layout for Borderless Printing

This section describes the concepts and settings methods for borderless printing using the Epson printer driver.



- With borderless printing, ink may cause the label and your hands to be smudged with ink, or may adhere to the inside of the printer and cause malfunctions
- Reducing ink smudges/stains or white banding may be possible by providing 1.5 mm (0.06 inches) width top margin in the print area.

### Borderless Printing Concepts

You can achieve borderless printing by adjusting the Left & Right Gap in the printer driver so that the print start position is aligned with the left edge of the label.

Use label paper that has waste parts around each label (adhesive paper around the outside of the label that is discarded) to prevent the backing paper from being smudged with ink.



Adjust the Left & Right Gap

Label

Waste

Backing paper

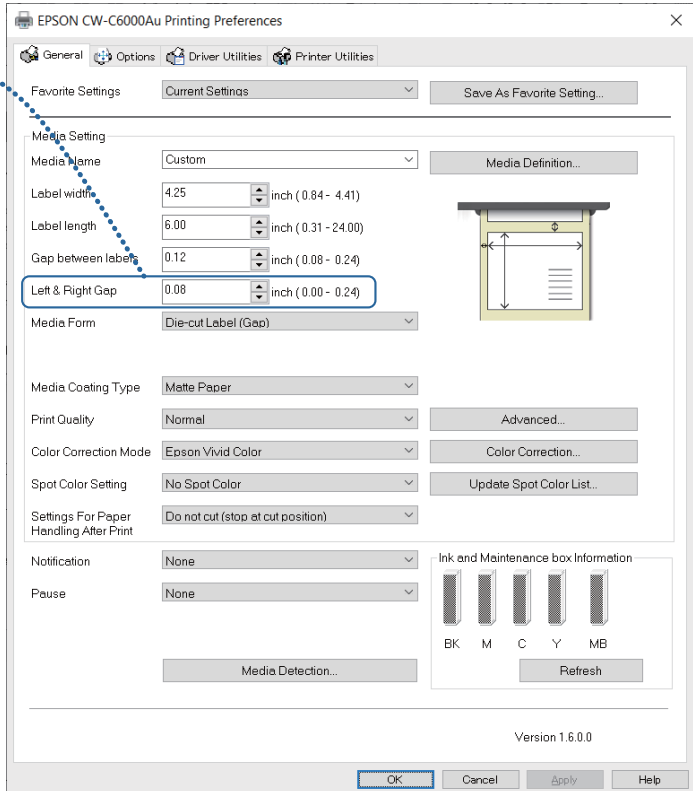

EPSON CW-C6000Au Printing Preferences

Media Setting

Media Name: Custom

Label width: 4.25 inch (0.84 - 4.41)

Label length: 6.00 inch (0.31 - 24.00)

Gap between labels: 0.12 inch (0.08 - 0.24)

**Left & Right Gap: 0.08 inch (0.00 - 0.24)**

Media Form: Die-cut Label (Gap)

Media Coating Type: Matte Paper

Print Quality: Normal

Color Correction Mode: Epson Vivid Color

Spot Color Setting: No Spot Color

Settings For Paper Handling After Print: Do not cut (stop at cut position)

Notification: None

Pause: None

Ink and Maintenance box Information: BK M C Y MB

Version 1.6.0.0



If you use die-cut labels that have no waste parts around each label, the label, your hands, and the inside of the printer might become smudged with ink.

## Label Media Settings

- When using die-cut labels, use kiss cut die-cut label paper that has waste parts around each label. However, there should be no waste parts at both side edges of roll paper.
- The Windows driver and PrinterSetting perform the following input value check and automatic correction.
  - \* The input value check makes sure that the Left & Right Gap multiplied by 2 and added to the label width does not exceed the maximum media width. Furthermore, if the input value exceeds the maximum (minimum) media width, the upper limit (lower limit) of the input value is restricted so that it does not exceed the maximum (minimum) media width.
- The input value check and automatic correction are only performed with the Windows driver and Printer Settings. Therefore, if you use any other driver to make layout settings such as the Left & Right Gap and label width, and the print range is exceeded, only the section within the printable range will be printed.

## ***Adjusting Sensitivity of the Detectors and Threshold for Detecting Labels***

The printer is equipped with two detectors; one detects leading edge of each label and another one detects black marks.

If you have labels that cannot be detected by the printer, the labels may become detectable by changing sensitivity of the detectors and/or threshold for detecting labels.

Change the settings using the operation panel.

[Menu] - [Maintenance] - [Calibration]

### **Simple Media Detect**

Allows you to adjust the threshold for detecting labels. Since this adjustment can be made in a short time, perform this adjustment first.

### **Media Detect**

Allows you to adjust the sensitivity of the detectors and the threshold for detecting labels. Perform this adjustment if your labels still cannot be detected after performing the [Simple Media Detect] adjustment.

## Adjusting Gap Detector

When printing on odd-shaped labels such as circle or oval labels, adjust the gap detectors as described below.



This adjustment is not required when using labels that are general in shape, such as square labels and full-page labels.

- 1 Remove paper from the printer.**  
("How to Remove Paper (For the Auto Cutter Model)" on page 66 , "How to Remove Paper (For the Peeler Model)" on page 68)
- 2 Turn off the printer.**
- 3 Adjust the detectors by operating the two adjustment tabs.**  
Push and move the adjustment tab horizontally using a fine-tipped tool such as a pen.  
The tab can be moved in increments of 5 mm (0.2 inches) within the range of 10 to 63 mm (0.39 to 2.48 inches) from the paper edge.  
Align the center of the circle on the adjustment tab with the scale mark.

Detector adjustment tab (light receiving unit)

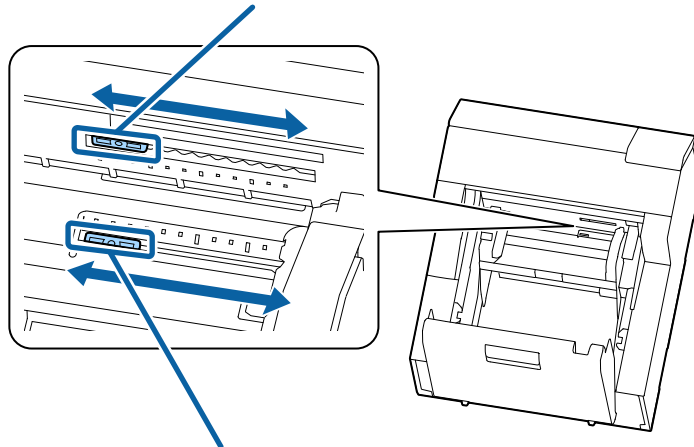

Detector adjustment tab (light emitting unit)



- Make sure to adjust the detectors before printing on odd-shaped labels.
- Make sure to turn off the printer to adjust the detectors. If you adjust the detectors with the printer powered on, the detector may malfunction resulting in starting auto paper feeding.
- Make sure to set the two detectors to the same position. If the position is different between the two detectors, printing will become impossible causing a paper detection error.

OK

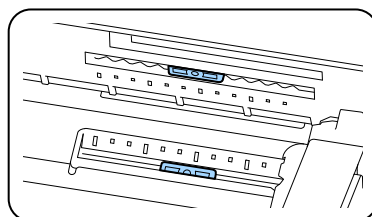

Not good

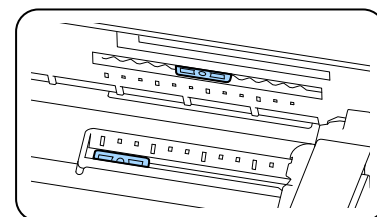

## Adjusting Label Detector for Circle Die-cut Labels (Example)

Align the center of the circle die-cut label, which is shown by dotted line in the figure, with the adjustment tabs.

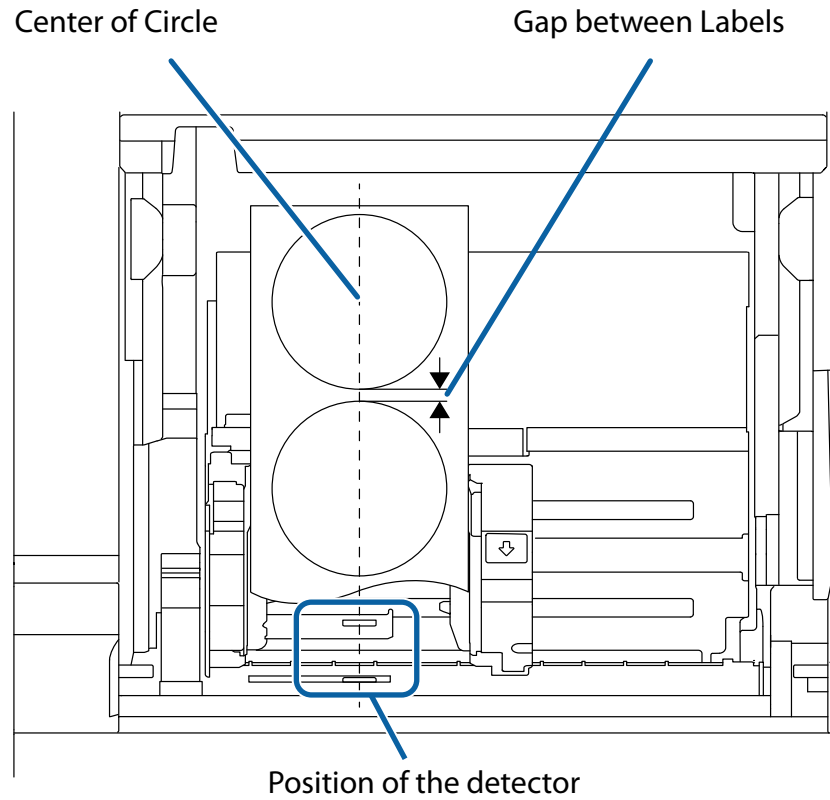

## Restricting Operation of the Operation Panel (Lock Setting function)

The [Lock Setting] function allows an administrator to lock the paper settings, printer settings, and/or system administration related settings to prevent unauthorized changes.

The procedure is as follows.

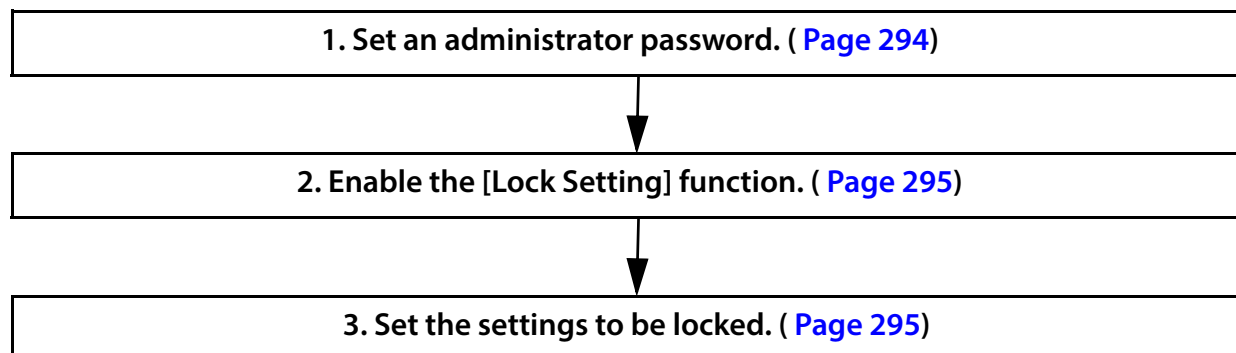

The following settings can be locked.

General Settings: Settings that are rarely changed once you configure them, such as the network settings and date/time settings.

Media Settings: Settings related to media (paper)

Printer Settings: Menus for adjusting or maintaining the printer and the print settings

To know which menu or setting can be locked, see "[Operation Panel Settings](#)" on page 229.

### Setting an Administrator Password



If there is a password label applied to the rear of the printer, the value for "PASSWORD" is the initial value.



In the example shown, the initial password is 03212791.

- 1** Select [Menu] - [General Settings] - [System Administration] - [Security Settings] - [Admin Settings] in that order.
- 2** Select [Admin Password] - [Register] in that order.
- 3** Enter an administrator password, and then select [OK] on the screen.



Set the new password using alphanumeric characters and symbols, with a length of eight or more characters but no more than 20 characters.

- 4** Enter the password again, and then select [OK] on the screen.
- 5** When a message is displayed, press the OK button.

## Enabling the [Lock Setting] Function

Set an administrator password in advance.

- 1** Select [Menu] - [General Settings] - [System Administration] - [Security Settings] - [Admin Settings] in that order.
- 2** Set [Lock Setting] to [On].  
Options that allow you to set which settings to lock are displayed.
- 3** Select the target options you want to lock, set it to [On], and then press the OK button.



When you set [Lock Setting] to [On], the [General Settings] option is automatically set to [On]. You cannot change it to [Off].

- 4** When a confirmation message is displayed, select [Yes].

Once the Lock Setting is enabled, the administrator password is required when changing any one of the locked settings.

## Changing the Administrator Password

- 1** Select [Menu] - [General Settings] - [System Administration] in that order.
- 2** Enter the current administrator password, and then select [OK] on the screen.
- 3** Select [Security Settings] - [Admin Settings] - [Admin Password] - [Change] in that order.
- 4** Enter the current administrator password, and then select [OK] on the screen.
- 5** Enter a new administrator password, and then select [OK] on the screen.



Set the new password using alphanumeric characters and symbols, with a length of eight or more characters but no more than 20 characters.

- 6** Enter the new password again, and then select [OK] on the screen.
- 7** When a message is displayed, press the OK button.

## Resetting the Administrator Password

If you forgot the password, reset the password following the procedure below.



The setting value when the administrator password was reset depends on whether there is a password label on the rear of the printer.

- If there is a password label  
The value for "PASSWORD" on the password label is set.



In the example shown, the password set is 03212791.

- If there is no password label  
It is not set.

**1** Press the  (home) button to return to the home screen.

**2** Hold down the  (back) button and the Cancel button at the same time.

**3** When a confirmation message is displayed, select [Yes].

**4** Enter the password to unlock, and then select [OK] on the screen.

The password to unlock depends on whether there is a password label applied to the rear of the printer.

- If there is a password label  
Enter the value for "PASSWORD" on the password label.



In the example shown, the initial password is 03212791.

- If there is no password label  
Enter "1234".



Even if there is a password label on the rear of the printer, it might not be possible to initialize the printer depending on the firmware version. In that case, enter "1234".

**5** When a message is displayed, press the OK button.

# Cleaning the Printer

This chapter describes how to carry out maintenance of the printer.

## Front

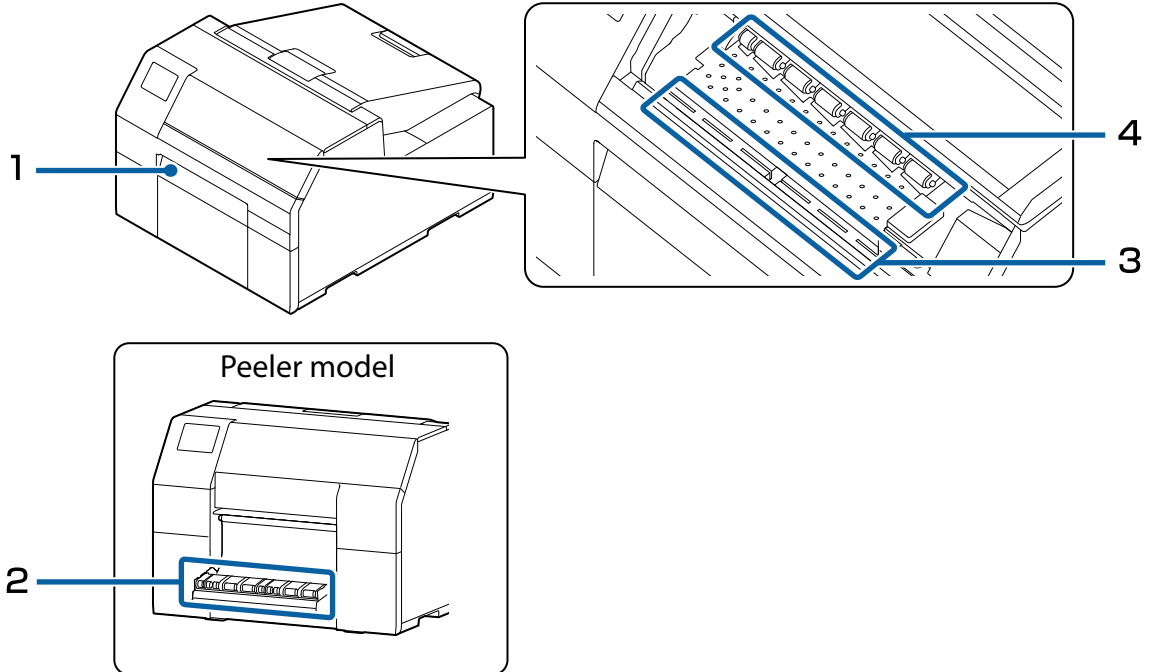

1	<a href="#">Cleaning the Auto Cutter (Auto Cutter Model Only)( Page 299)</a>
2	<a href="#">Cleaning the Peeler (Peeler Model Only)( Page 300)</a>
3	<a href="#">Cleaning the Platen( Page 302)</a>
4	<a href="#">Cleaning the Paper Pressure Roller ( Page 306)</a>

## Rear

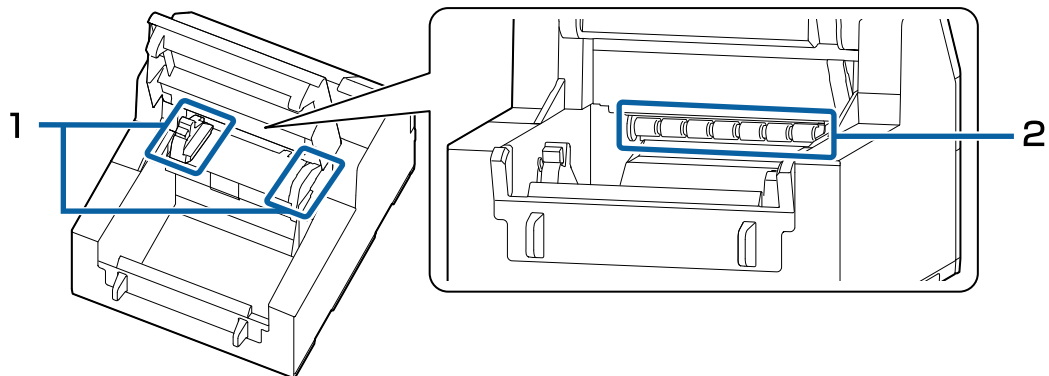

1	<a href="#">Cleaning the Edge Guides( Page 301)</a>
2	<a href="#">Cleaning the Paper Feed Roller ( Page 303)</a>

## Cleaning the Exterior

Turn off the printer, and then wipe off any dirt with a dry cloth or non-woven fabric that has been dampened. Make sure to unplug the printer when cleaning it.



Do not use alcohol, benzine, thinner, trichloroethylene, or ketone based solvent to clean the exterior of the printer.

Doing so may deform or damage the plastic and rubber parts.

## Cleaning the Auto Cutter (Auto Cutter Model Only)

If labels, paper dust, or adhesive has adhered to the fixed blade of the auto cutter, the blade may become dull. Clean the fixed blade following the procedure below.

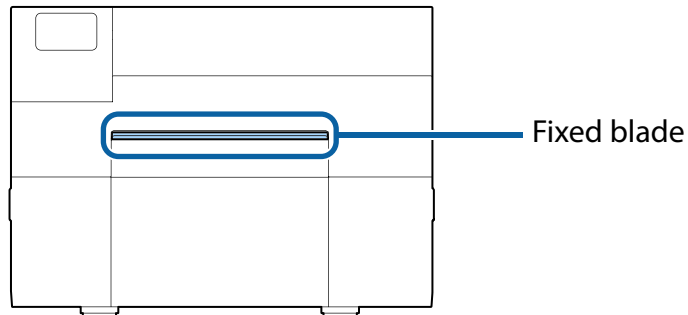

- 1** If paper has been loaded, remove it.  
(["How to Remove Paper \(For the Auto Cutter Model\)"](#) on page 66)
- 2** Turn off the printer, and unplug the power cable.
- 3** As shown in the figure below, scrape off adhered materials stuck to the fixed blade using a flat-blade screwdriver (blade width: 1.8 mm to 3 mm (0.07 inches to 0.12 inches)). Start scraping from each end toward the center.

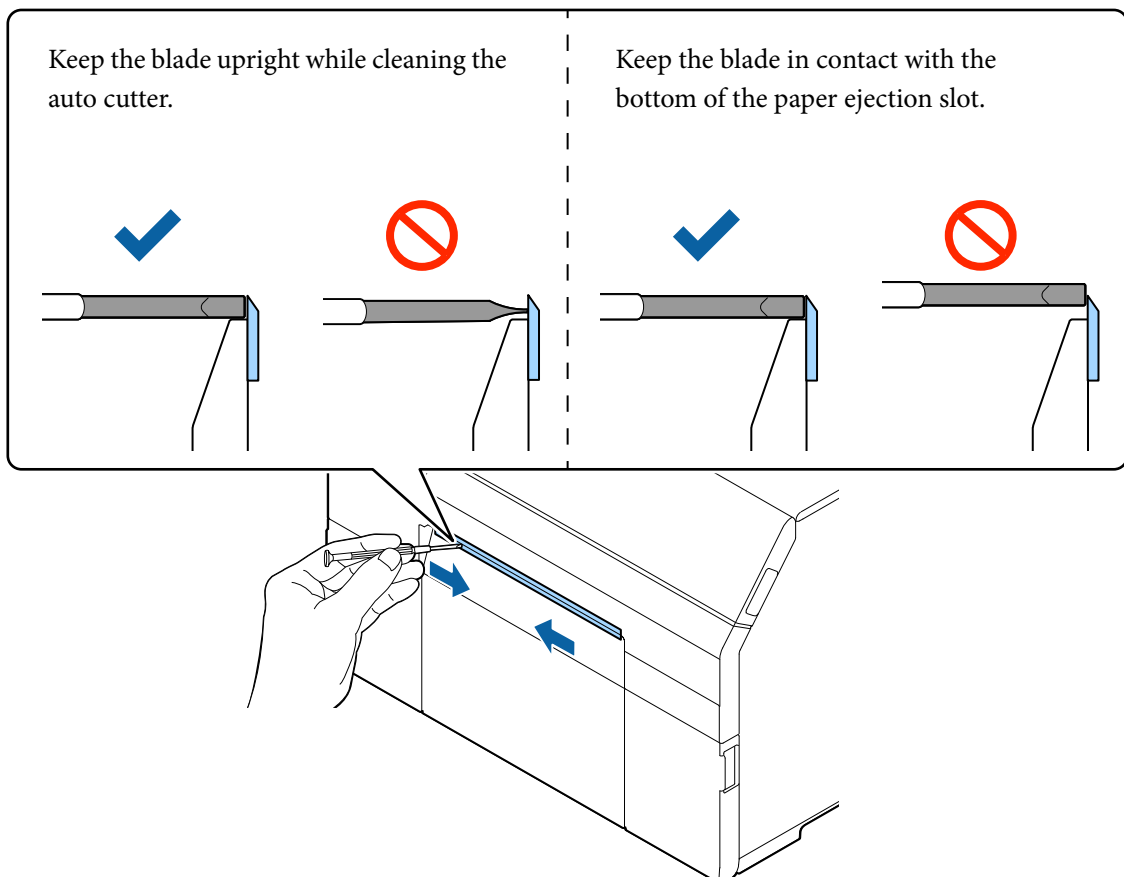

## Cleaning the Peeler (Peeler Model Only)

If labels, paper dust, or adhesive has adhered to the peeler, the print quality may decline.

To maintain good print quality, it is recommended to clean the peeler every day.

Clean the peeler following the procedure below.



- Do not use benzine, thinner, trichloroethylene, or ketone based solvent. Doing so may deform or damage the plastic and rubber parts.
- Do not spray or allow alcohol to drip directly on the printer. If alcohol gets inside the printer, it may short-circuit the electronic components or cause deterioration or damage to the components.
- After cleaning, wipe with a dry cloth so that no alcohol remains on the surface.
- Do not connect the power plug or operate the power supply until the alcohol has completely dried.

**1** Turn off the printer, and unplug the power cable.

**2** Open the peeler cover.

If paper has been loaded, remove it.

(["How to Remove Paper \(For the Peeler Model\)"](#) on page 68)

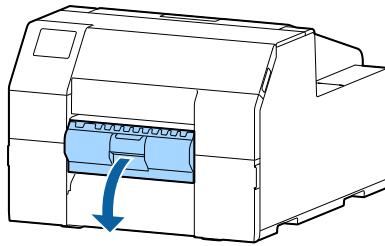

**3** Clean the roller using a cotton swab moistened with alcohol.

Completely remove dirt from the roller.

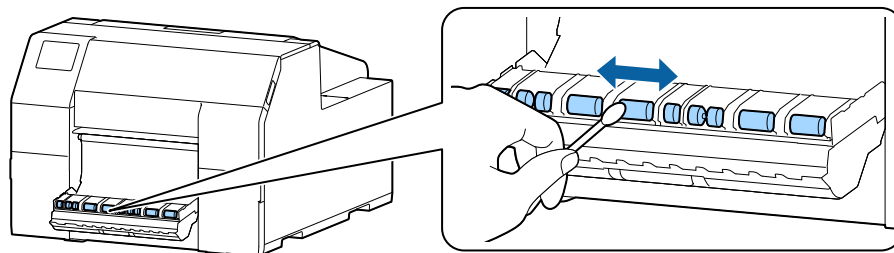

## Cleaning the Edge Guides

If labels, paper dust, or adhesive has adhered to the edge guides, paper may get jammed, or printing position may become incorrect.

Clean the edge guides following the procedure below.



- Do not use benzene, thinner, trichloroethylene, or ketone based solvent. Doing so may deform or damage the plastic and rubber parts.
- Do not spray or allow alcohol to drip directly on the printer. If alcohol gets inside the printer, it may short-circuit the electronic components or cause deterioration or damage to the components.
- After cleaning, wipe with a dry cloth so that no alcohol remains on the surface.
- Do not connect the power plug or operate the power supply until the alcohol has completely dried.

**1** Turn off the printer, and unplug the power cable.

**2** Open the paper cover.

If paper has been loaded, remove it.

("How to Remove Paper (For the Auto Cutter Model)" on page 66, "How to Remove Paper (For the Peeler Model)" on page 68)

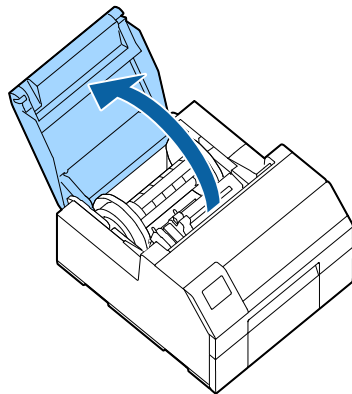

**3** Clean the edge guides using a cotton swab moistened with alcohol.

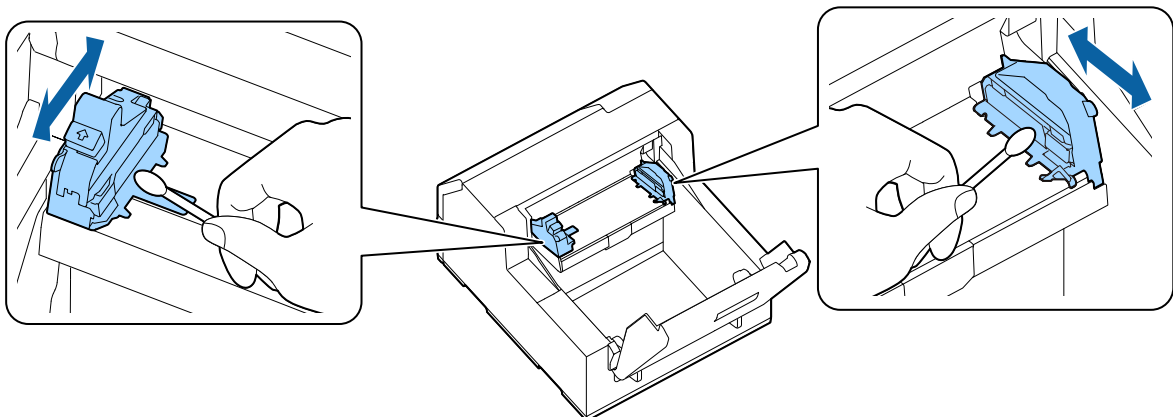

## Cleaning the Platen

If labels, paper dust, or adhesive has adhered to the platen, paper may get jammed, or printing position may become incorrect.

Clean the platen following the procedure below.

- 1** Turn off the printer, and unplug the power cable.
- 2** If paper has been loaded, remove it.  
("How to Remove Paper (For the Auto Cutter Model)" on page 66, "How to Remove Paper (For the Peeler Model)" on page 68)
- 3** Open the front cover.
- 4** Raise the paper holder unit.

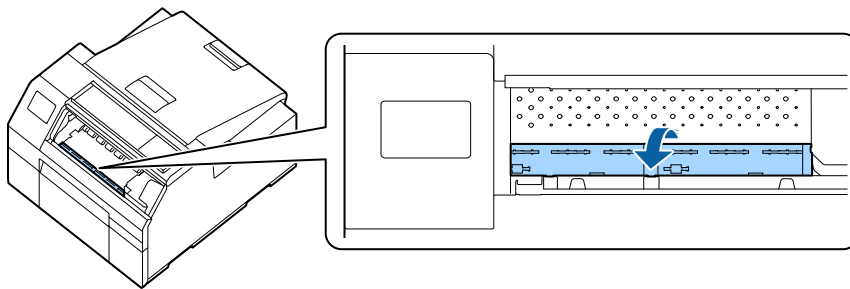

- 5** Use a cloth or cotton swab to remove adhesive adhered to the platen.

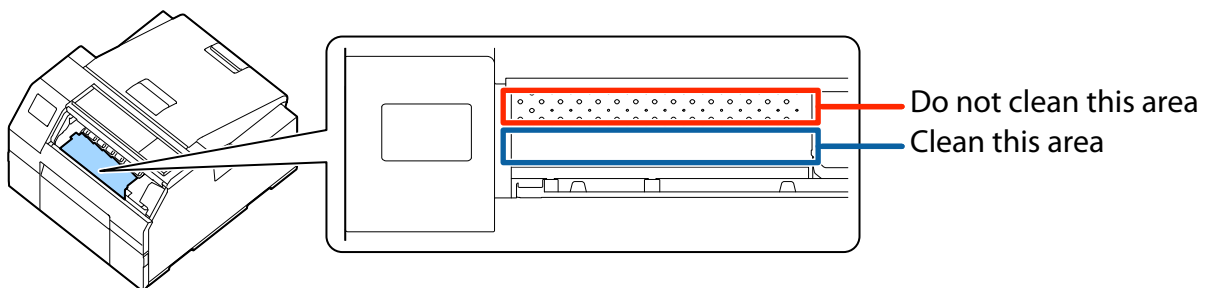

- 6** Lower the paper holder unit.

## Cleaning the Paper Feed Roller

If paper dust or adhesive has adhered to the paper feed roller, paper may get jammed, or faint or blurred image may be printed.

To maintain good print quality, it is recommended that the rollers are cleaned once a week.

Clean the roller following the procedure below.



### CAUTION

When cleaning the paper feed roller, do not use a material other than labels. Doing so may damage the roller resulting in paper jam, or faint or blurred printout.

- 1** Turn off the printer, and unplug the power cable.
- 2** Open the paper cover.  
If paper has been loaded, remove it.  
(["How to Remove Paper \(For the Auto Cutter Model\)"](#) on page 66, ["How to Remove Paper \(For the Peeler Model\)"](#) on page 68)

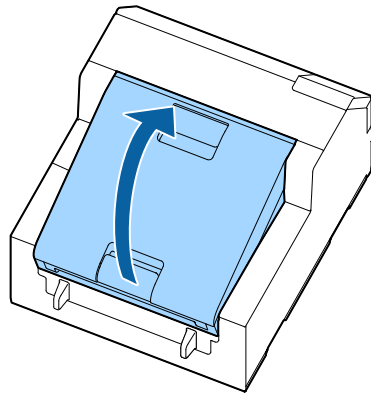

- 3** Remove the spindle.

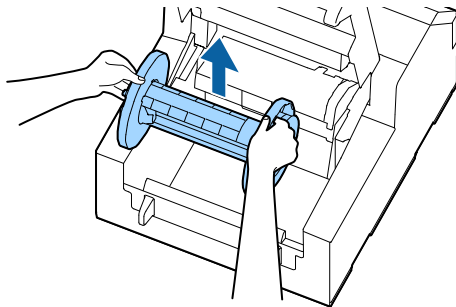

#### 4 Raise the release lever.

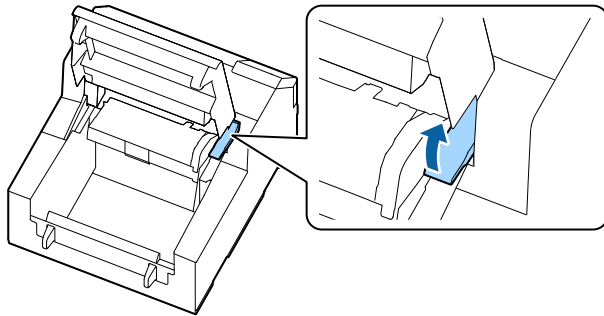

#### 5 Open the paper guide unit.

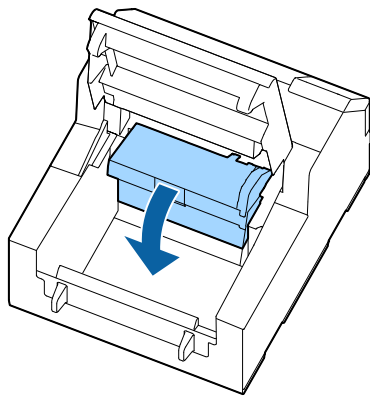

#### 6 Attach adhesive side of a label to the roller, and peel it off slowly. Repeat this action until paper dust or adhesive is completely removed from side to side of the roller. If some labels have stuck on the roller, carefully remove them as they can cause a paper jam.

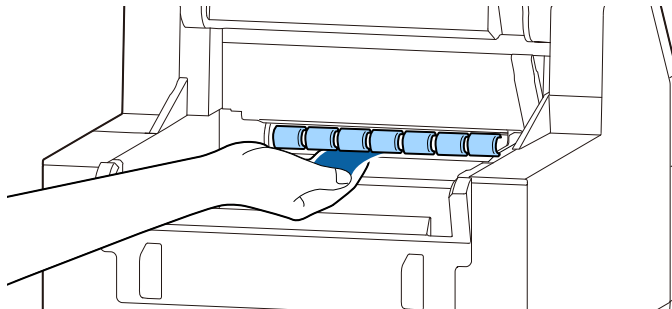

- 7 Rotating the roller by hand, remove paper dust or adhesive from entire surface of the roller.

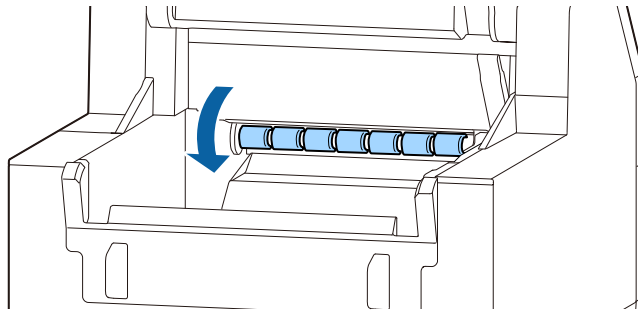

## Cleaning the Paper Pressure Roller

In order to prevent problems such as paper jams or shifts in the print results, if any paper dust or adhesive has adhered to the paper feed roller, clean it following the procedure below.



- Do not use benzine, thinner, trichloroethylene, or ketone based solvent. Doing so may deform or damage the plastic and rubber parts.
- Do not spray or allow alcohol to drip directly on the printer. If alcohol gets inside the printer, it may short-circuit the electronic components or cause deterioration or damage to the components.
- Do not allow alcohol to come into contact with any sections besides the paper pressure rollers.
- If you use alcohol to clean the printer, be sure to use printer paper to prevent alcohol from getting on the paper feed roller. If alcohol gets on the paper feed roller, the print quality might decline.
- After cleaning, wipe with a dry cloth so that no alcohol remains on the surface.
- Do not connect the power plug or operate the power supply until the alcohol has completely dried.

**1** Turn off the printer, and unplug the power cable.

**2** Open the paper cover.

If paper has been loaded, remove it.

(["How to Remove Paper \(For the Auto Cutter Model\)"](#) on page 66, ["How to Remove Paper \(For the Peeler Model\)"](#) on page 68)

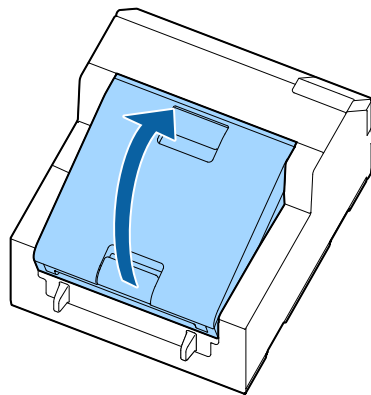

**3** Remove the spindle.

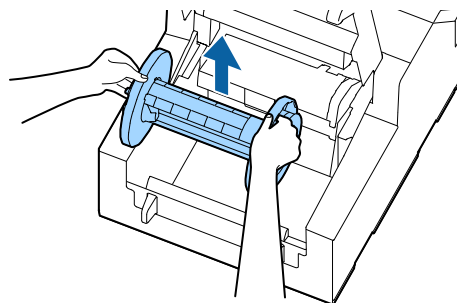

#### 4 Raise the release lever.

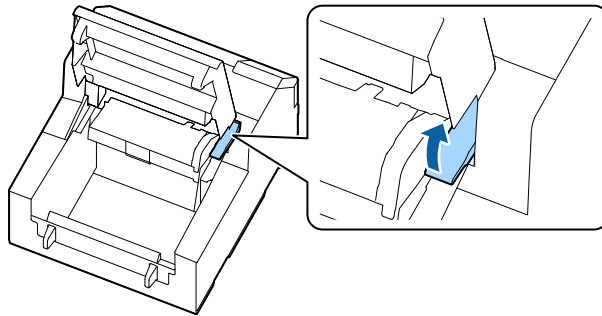

#### 5 Open the front cover.

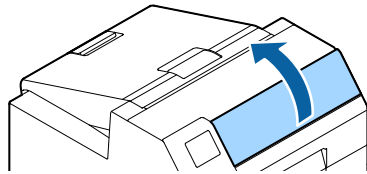

#### 6 Use printer paper to prevent alcohol from getting on the paper feed roller.

Confirm that all the rollers are covered by printer paper before cleaning. If using multiple sheets of paper, lay them on one another so that there are no gaps.

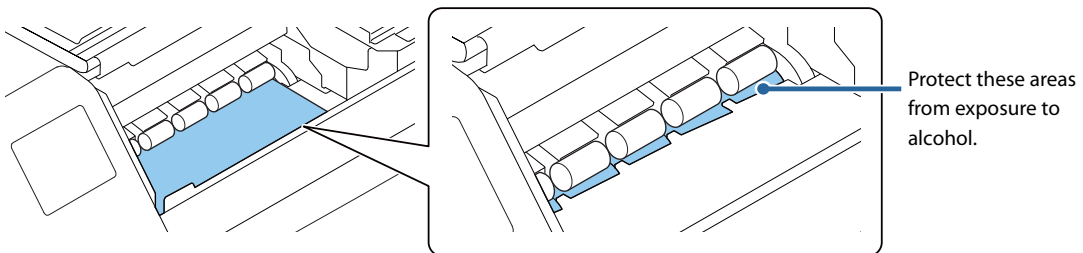

#### 7 Use a cotton swab or non-woven fabric moistened with alcohol to clean the roller.

Carefully remove any labels that become stuck on the roller. Otherwise, they could cause a paper jam.

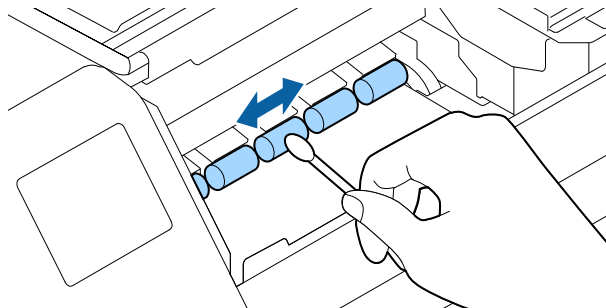

- 8 Rotating the roller using a cotton swab or non-woven fabric, remove the adhered paper dust or adhesive from the entire surface of the roller.

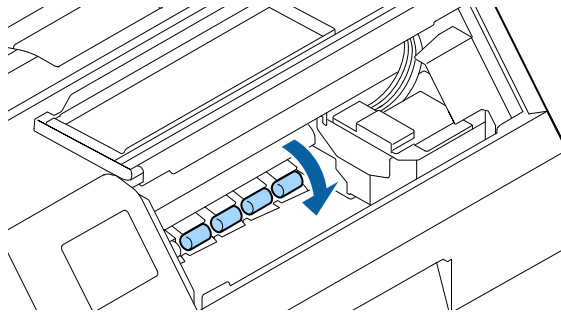

## Print Head Cleaning

If the nozzles are clogged, faint colors, banding, or unintended colors appear on printouts. When such print quality problems occur, print nozzle check patterns and check for nozzle clogging.

(["Test Print" on page 73](#))

### Example of the nozzle check patterns with gloss black ink

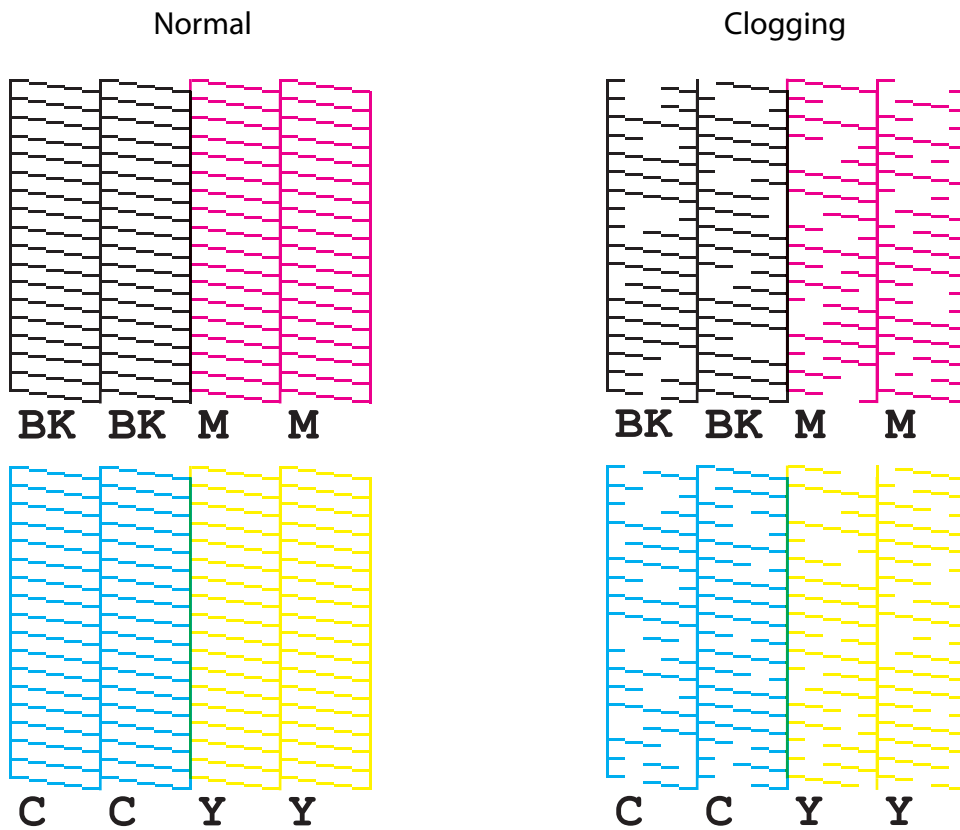

If nozzles are clogged, run a print head cleaning. Run [Power Cleaning] only when nozzle clog is not cleared by running [Print Head Cleaning].

To run a print head cleaning, select the menu as described below.



The [Power Cleaning] consumes ink more than [Print Head Cleaning].

## Using the Operation Panel

[Menu] - [Maintenance] - [Print Head Cleaning]

[Menu] - [Maintenance] - [Power Cleaning]

## Using the Printer Driver

Click [Print Head Cleaning] or [Power Cleaning] on the [Printer Utilities] window.

## Using the Web Config

Select [Print Head Cleaning] on the [Maintenance] window. Then select the cleaning type from [Auto] or [Power Cleaning], and then click [Start].

For details on Web Config, see "[Web Config](#)" on page 243.



## Storing the Printer After Ink is Charged

### Preparation for Long-Term Storage



If you need to store the printer for long periods after installing the ink cartridges, follow the procedure below.

- 1 **Run the nozzle check to confirm that the print head nozzles are not clogging and there is no problem with the print quality. If the print quality is not good, run a print head cleaning.**

See "Test Print" on page 73.



 <b>CAUTION</b>	<p>If you store the printer without solving the print quality problem (nozzle clogging), ink inside the nozzles may get hard and the print quality problem may become unrecoverable when you start using the printer again.</p>
	<p>If you have transported the printer after installing the ink cartridges, nozzle clogging may occur due to vibrations applied to the printer during the transport.</p>

- 2 **When printing is finished, press the  (Power) button to turn off the printer.**

 <b>CAUTION</b>	<p>Especially when storing the printer for long periods, make sure to turn it off using the  (Power) button.</p>
---	---

- 3 **Store the printer in a cool and dark place.**

For information about environmental requirements for storing the printer, see "[Environmental Specifications](#)" on page 398.

 <b>CAUTION</b>	<p>The storage life of the ink cartridges is six months.</p>
	<p>Make sure to store the printer with all ink cartridges installed.</p>

## Transporting or Storing the Printer at -10°C (14°F) (With Matte Black Ink Installed)

If the ambient temperature becomes -10°C (14°F) or lower, the print head may be damaged. If -10°C (14°F) or lower ambient temperature is expected, discharge ink in advance following the procedure below.



- Since ink is discharged to the maintenance box, the box needs to have enough remaining space for the discharged ink. If the remaining space in the box is not enough, have a new maintenance box ready for replacement.
- During the ink discharging work, keep the ambient temperature between 5 to 35 degrees C (41 to 95°F).
- While the printer is discharging ink, do not open any cover or turn off the printer.

- 1 If paper has been loaded, remove it.**
- 2 Select the menus on the operation panel in the order shown below.**  
[Menu] - [Maintenance] - [Ink Discharging]
- 3 When a confirmation message is displayed, select [Start].**  
Ink discharging is started. When discharging ink is finished, the printer is automatically turned off.



When you use the printer next time, you need to recharge ink to the printer. When the printer is turned on, a confirmation screen for recharging ink appears. Select [OK] to start recharging ink. It takes about 5 to 14 minutes. When recharging ink is finished, a home screen appears.

## For Using the Printer after Long Storage

When using the printer after storing it for long periods, follow the procedure below.

- 1 Check the ink cartridges to see if they are expired.**



Replace the ink cartridges with new ones in the following cases.  
For instructions on how to replace the cartridges, see ["Installing the Ink Cartridges" on page 41](#).

- Three years or more have passed from the manufacturing date.
- Six months or more have passed from when the cartridge was installed in the printer.

- 2 Turn the printer on.**  
The auto self-check function checks the nozzles for clogging and run a cleaning.



**CAUTION**

While the printer is running the print head cleaning, do not turn off the power or open the ink cartridge cover, front cover, paper cover, and the maintenance box cover.

- 3 Run the nozzle check to confirm that the print head nozzles are not clogging and there is no problem with the print quality.**

## For Transporting the Printer

When transporting the printer, make sure to follow the guidelines below.



- The weight of the printer is approximately 26 kg (57.32 lb). When lifting the printer, make sure to lift it by two people placing the hands at the dents on the printer. If you put your hands on the other portions of the printer to lift it, the printer may get damaged.

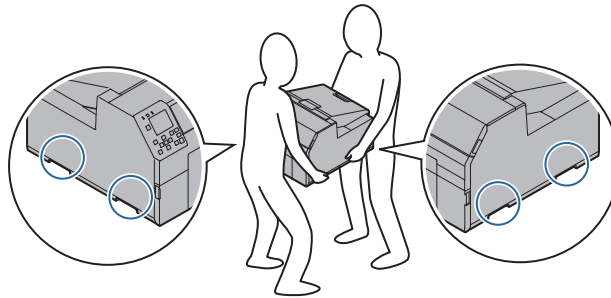

- Make sure to remove paper before transporting the printer.
- Do not remove the ink cartridges and the maintenance box for transporting the printer.
- When turning off the printer for transporting, make sure to turn off the printer with the  (Power) button.
- Do not let the printer tilt to all directions by 10 degrees or more during transportation. Otherwise, the printer may fall down causing an accident.
- Do not let the printer upside down or lay on its side during transportation.

# Troubleshooting

## A message is displayed on the operation panel.

Message	Meaning	Solution
Information Close the paper cover.	The paper cover is open.	Close the paper cover. ( <a href="#">"Part Names and Functions" on page 20</a> )
Information Close the front cover.	The front cover is open.	Close the front cover. ( <a href="#">"Part Names and Functions" on page 20</a> )
Information Close the release lever.	The release lever is open.	Close the release lever. ( <a href="#">"Part Names and Functions" on page 20</a> )
Information Close the paper guide unit.	The paper guide unit is open.	Close the paper guide unit. ( <a href="#">"Part Names and Functions" on page 20</a> )
Information Close the maintenance box cover.	The maintenance box cover is open.	Close the maintenance box cover. ( <a href="#">"Part Names and Functions" on page 20</a> )
Information Close the ink cartridge cover.	The ink cartridge cover is open.	Close the ink cartridge cover. ( <a href="#">"Part Names and Functions" on page 20</a> )
Information Paper feed error. Load the paper or change the media source setting.	The loaded paper is different from the [Media Source] and [Media Form] settings.	Use paper that matches the [Media Source] and [Media Form] settings. Or change the [Media Source] and [Media Form] settings to match them with the loaded paper. ( <a href="#">"Media Settings" on page 49</a> )
Information Cannot detect the roll paper. Reload the paper or change the media detection setting.	The loaded paper is different from the [Media Detect] settings.	Use paper that matches the [Media Detect] settings. Or change the [Media Detect] settings to match them with the loaded paper. ( <a href="#">"Media Settings" on page 49</a> )
Information Cannot detect the fanfold paper. Reload the paper or change the media detection setting.	The loaded paper is different from the [Media Detect] settings.	Use paper that matches the [Media Detect] settings. Or change the [Media Detect] settings to match them with the loaded paper. ( <a href="#">"Media Settings" on page 49</a> )
(On the home screen) Load paper.	There is no paper.	Load paper. ( <a href="#">"Opening the Paper Cover" on page 50</a> )
Information The paper size set in the printer may differ from the print setting.	The media size differs from the print data size.	Load media that matches the print area size. Or change the print area to match it with the media size. ( <a href="#">"Media Settings" on page 49</a> )
Information The roll paper is not loaded.	The roll paper is not loaded.	Load roll paper. ( <a href="#">"Opening the Paper Cover" on page 50</a> )

Message	Meaning	Solution
Information The fanfold paper is not loaded.	The fanfold paper is not loaded.	Load fanfold paper. ( <a href="#">"Opening the Paper Cover" on page 50</a> )
Information Paper jam.	A paper jam has occurred.	Remove the jammed paper and then load paper. ( <a href="#">"Paper is jammed" on page 328</a> )
Information The paper is not loaded correctly. Remove the paper from the top of the paper guide, close the paper cover, and then press the Pause button.	The paper has not been loaded correctly.	Remove the paper, and then load the paper again. See <a href="#">"How to Remove Paper (For the Auto Cutter Model)" on page 66</a> or <a href="#">"How to Remove Paper (For the Peeler Model)" on page 68</a> , and <a href="#">"Opening the Paper Cover" on page 50</a> If this error occurs during loading paper, reload the paper in accordance with the following procedure. Open the paper cover --> Remove paper from the upper paper guide --> Close the paper cover --> Press the Pause button When the home screen is displayed on the operation panel, open the cover and then load the paper. ( <a href="#">"Loading Paper" on page 51.</a> ) If the error still occurs, check that the gap detectors are positioned correctly. ( <a href="#">"Adjusting Gap Detector" on page 292.</a> )
Information Calibration failed. Press the OK button. Then reload or replace the paper.	Calibration is failed.	Make sure that the paper loaded in the printer matches the paper detection method (gap or black mark), and reset the paper. ( <a href="#">"Opening the Paper Cover" on page 50</a> ) If the error still occurs, the detector cannot handle the paper. Replace the paper.
Information The paper has already been cut and cannot be cut.	The printer failed to cut the paper.	This error occurs when you press the Cut button at the position where the paper is already cut. Feed the paper by printing or pressing the Feed button to enable the Cut button.
Maintenance Error The ink cartridge is not installed correctly.	An ink cartridge is not installed.	Install an ink cartridge with a sufficient amount of ink remaining. ( <a href="#">"Replacing the Ink Cartridges" on page 42</a> )
(On the home screen, an exclamation mark on the ink levels)	The ink level is low.	Prepare a new ink cartridge to be replaced with the low-ink-level cartridge. If you continue to use the low-ink-level cartridge, you may be required to replace it during printing. If you replace the cartridge during printing, you may see a difference in color between colors printed by the old cartridge and colors printed by the new one due to a difference in ink drying status. If it is not acceptable for you, replace the ink cartridge with a new one before starting printing. ( <a href="#">"Replacing the Ink Cartridges" on page 42</a> ) The removed ink cartridge can be installed again and used until you are prompted to replace it.

Message	Meaning	Solution
Information You need to replace Ink Cartridge(s).	The printer cannot print because the ink cartridge is expended.	Install an ink cartridge with a sufficient amount of ink remaining. ( <a href="#">"Replacing the Ink Cartridges" on page 42</a> )
Maintenance Error Cannot recognize the ink cartridge. Select "Next" to clear the error.	The ink cartridge information cannot be read.	Reinstall the ink cartridge. If the error reoccurs, replace the ink cartridge with a new one. ( <a href="#">"Replacing the Ink Cartridges" on page 42</a> )
Information You have not installed genuine Epson ink cartridges.	The installed ink cartridges are not genuine Epson cartridges.	For the best performance of the printer, it is recommended to use genuine Epson ink cartridges. Use of non-genuine Epson ink cartridges can adversely affect the printer and print quality and prevent the printer from realizing its maximum performance. Epson cannot guarantee the quality and reliability of non-genuine Epson products. Repairs for any damage or breakdown of this product due to the use of non-genuine Epson products will not be free of charge even if the warranty period is still valid.
Information This ink cartridge is inapplicable.	The installed ink cartridges are not the cartridges for this printer.	Because the installed ink cartridges are not the ones for this printer, an error such as a cartridge detection error may occur.
Maintenance Error A maintenance box is not installed.  Model number: SJMB6000/6500	A maintenance box is not installed.	Install a new maintenance box. ( <a href="#">"Replacing the Maintenance Box" on page 44</a> )
Maintenance Error Cannot recognize the maintenance box.  Model number: SJMB6000/6500	The printer cannot read the information of the maintenance box.	Reinstall the maintenance box. If the error reoccurs, replace the maintenance box with a new one. ( <a href="#">"Replacing the Maintenance Box" on page 44</a> )
(On the home screen) The Maintenance Box is nearing end of its service life.	The maintenance box is near full.	Prepare a new maintenance box to be replaced with the near-full maintenance box. When a message saying "The Maintenance Box is at the end of its service life. You need to replace it." is displayed, replace the maintenance box.
Maintenance Error The Maintenance Box is at the end of its service life. You need to replace it.  Model number: SJMB6000/6500	The printer cannot print because the maintenance box has no remaining amount of space.	Replace the maintenance box with a new one. ( <a href="#">"Replacing the Maintenance Box" on page 44</a> )

Message	Meaning	Solution
Information Memory Full. Document was not printed.	Printing is impossible because the printer has run out of memory.	Delete unnecessary files.
(On the home screen) Maintenance Request: Replace Parts Soon XXXXXXXX	The printer internal parts have almost reached the end of their service life.	You will need to replace the parts. Contact qualified service personnel for advice. When contacting, tell the person the "XXXXXXXX" (a 6- or 8-digit alphanumeric code). This message cannot be cleared until the part is replaced. If the part reaches the end of its service life, printing is disabled.
Maintenance Request: End Of Parts Service Life Turn on the printer again. See your documentation for more details. XXXXXXXX	The printer internal parts have reached the end of their service life.	Printing is disabled until you replace the parts. Contact qualified service personnel for advice. When contacting, tell the person the "XXXXXXXX" (a 6- or 8-digit alphanumeric code).
Printer Error Turn on the printer again. See your documentation for more details.  XXXXXX	A printer error has occurred.	1. Turn off the printer. 2. Check that there is no paper jam or foreign materials near the ejection slot. 3. Turn the printer on. If the printer error still occurs, contact qualified service personnel for advice. When contacting, tell the person the "XXXXXXXX" (a 6- or 8-digit alphanumeric code).
Information Device restarted due to a system error.	A system error has occurred.	If the printer does not function normally after being restarted, contact qualified service personnel for advice. When contacting, tell the person the "XXXXXXXX" (a 6- or 8-digit alphanumeric code).
Information Cannot start cleaning because ink is low. Printer features except cleaning are available.	The remaining amount of ink is not sufficient for the print head cleaning.	When running the cleaning, install ink cartridges with a sufficient amount of ink remaining. <a href="#">("Replacing the Ink Cartridges" on page 42)</a>
Information Remove the label.	The printed label has not been removed.	Remove the labels from the peeler. If the error is not cleared, press the Peeler Reset button.
Information The print quality may decrease because the nozzles are clogged.	The print head nozzles are clogging.	The print quality may decrease because the nozzles are clogged. If it is not acceptable, run a print head cleaning. <a href="#">("Print Head Cleaning" on page 309)</a>

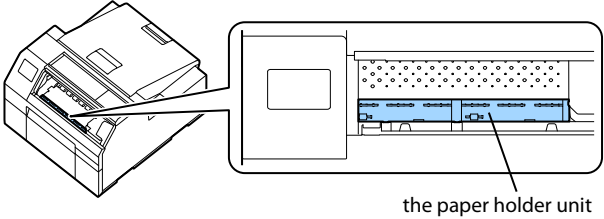

Message	Meaning	Solution
<p>Information</p> <p>Open front cover, and close paper hold unit.</p> 	<p>The paper holder unit is not completely closed.</p>	<p>Open the front cover, and then close the paper holder unit.</p> <p>When the paper holder unit is opened, a paper jam error may occur. If the paper jam error is not cleared, try the solutions described in the links below.</p> <p>Auto cutter model: <a href="#">"For the Auto Cutter Model" on page 328</a></p> <p>Peeler model: <a href="#">"For the Peeler Model" on page 332</a></p>
<p>Information</p> <p>The print quality may decrease because the status of nozzles cannot be detected.</p>	<p>The ambient temperature is out of the operating temperature range.</p>	<p>Adjust the room temperature so that it falls within 5 to 35 degrees C (41 to 95°F).</p>
<p>The printer can't connect to cloud service.</p> <p>Please check the connection status and settings with the cloud service.</p> <p>Please contact your administrator for details.</p>	<p>The printer is failing to connect to the Loftware Cloud.</p>	<p>Contact your system administrator for more information.</p>

## Print Quality Problems

Status	Cause	Solution
Horizontal White Banding	The nozzles are clogging.	<p>Print the nozzle check patterns to check the nozzles for clogging. (<a href="#">"Test Print" on page 73</a>)</p> <p>If the nozzles are clogging, run a print head cleaning. (<a href="#">"Print Head Cleaning" on page 309</a>)</p>
Vertical White Banding	The printed label has been back-fed.	<p>If printed labels are fed backward, the printed surface is damaged by the rollers located under the paper pressure unit.</p> <p>This can occur when the print mode is set to "Stop at Cut Position" or "Stop at Peel-Off Position", and printed labels have not been removed after each print job is finished.</p> <p>Select a print mode option other than "Stop at Cut Position" or "Stop at Peel-Off Position", or remove printed labels after each print job is finished.</p> <p>The print mode can be configured in the [Media Definition] settings of the printer driver. (<a href="#">"User-Defined Paper" on page 87</a>)</p>

Status	Cause	Solution
White or Black Banding	The paper is not loaded correctly.	Reload the paper. (" <a href="#">Opening the Paper Cover</a> " on page 50)
	The paper being used and the Media Coating Type setting differ.	Check the paper being used and the Media Coating Type setting of the printer driver. (" <a href="#">Printer Driver for Windows</a> " on page 75)
	White banding or black banding can occur if the paper feeding setting is not appropriate for the paper used.	Adjust the paper feed settings. The adjustment is available in [Print Head Alignment] of PrinterSetting. (" <a href="#">Print Head Alignment</a> " on page 206)
Unintended Top and Bottom Margins are Generated	If die-cut label (without black marks) thinner than required thickness is used, the printer may not be able to correctly detect the labels and cause unintended top and bottom margins on each label. (The "top and bottom" used here means the beginning and end of labels in the paper feed direction.)	Carry out [Print start position adjustment (Vertical direction)] of PrinterSetting. Enter a minus correction value to reduce the top margin, and enter a plus correction value to reduce the bottom margin. (" <a href="#">Position adjustment</a> " on page 193)
Printed Characters Look Blurred	Blurred print may occur when the printer settings are not appropriate for the thickness of the paper.	Carry out [Bi-directional Printing Adjustment] of PrinterSetting. (" <a href="#">Print Head Alignment</a> " on page 206)
Printed Colors Are Wrong	If the printer is moved after initial charging, the specified colors may not be output (colors may be mixed) due to vibrations and impacts.	Run a head cleaning and check that colors are no longer mixed. (" <a href="#">Print Head Cleaning</a> " on page 309)
Print Position Shift	The edge guide is not set along the paper edge.	Check that the edge guide is properly set at the paper width position. (" <a href="#">Opening the Paper Cover</a> " on page 50)
	The paper you are using is set at an angle. (Peeler model)	Make sure that the edge of the paper is aligned with the protrusion below the peeler cover. (" <a href="#">Media Settings</a> " on page 49)

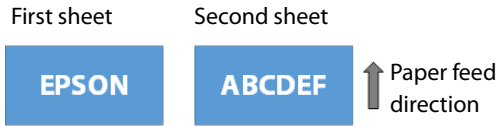
Status	Cause	Solution
Paper is Smearred or Smudged with Ink	The paper being used and the Media Coating Type setting differ.	Check the paper being used and the Media Coating Type setting of the printer driver. (" <a href="#">Printer Driver for Windows</a> " on page 75)
	If foreign matter is adhered to the head, the paper may be smeared with ink.	Run a print head cleaning. (" <a href="#">Print Head Cleaning</a> " on page 309)
	If the platen vacuum is insufficient for the paper, the paper may rub against the print head and be smeared with ink.	Media hold pressure might be required. Carry out the manual adjustment using the printer driver following the steps below. 1. Display the [General] window of the printer driver. 2. Click [Advanced] in the [Media Settings] field. The advanced settings window appears. 3. Select the check box for [Media Hold Pressure] in the [Paper Adjustment] field. The manual adjustment is enabled. 4. Move the slide bar to adjust the platen vacuum.
Part of print data is rimmed/Auto cut or Peeling position is Incorrect	The paper being used and the media definition (size settings) do not match.	If the paper and the media definition of the printer driver do not match, printing may not be at the correct position. Set the media definition correctly. (" <a href="#">User-Defined Paper</a> " on page 87)
	Shift of print and stop position may occur depending on the paper used.	Adjust the print start position using PrinterSetting. (" <a href="#">Position adjustment</a> " on page 193)

Status	Cause	Solution
<p>The Print Position for Variable Information (Text, Images, Etc.) Shifts</p> <p>Example) First sheet: Print "EPSON" Second sheet: Print "ABCDEF" as variable information</p> <p><b>If printed correctly</b></p> <p>First sheet      Second sheet</p>  <p><b>If the print position shifted</b></p> <p>First sheet      Second sheet</p> 	<p>A value other than 0% is set for [Vertical positioning] or [Horizontal positioning] in [Replace settings from printer using ZPL II commands] of PrinterSetting.</p>	<p>Set "Vertical positioning" and "Horizontal positioning" to 0%. (<a href="#">"Adjusting Font Width and Object Positioning" on page 351</a>)</p>

## Cannot Print

Status	Cause	Solution
Print Data is Sent, But Does Not Print (Peeler Model)	The label peeling detector is malfunctioning.	If printing is performed at a location exposed to strong light such as direct sun rays, etc., the label peeling detector may not work properly, making it impossible to perform printing. Press the Peeler Reset button to cancel the non-printing state.
Auto Paper Feeding does Not Start	The position of the gap detector is not correct.	Check the position of the gap detector. ( <a href="#">"Adjusting Sensitivity of the Detectors and Threshold for Detecting Labels" on page 291</a> )
	The sensor has failed.	If operation was normal up until now, the sensor has probably failed. Request repairs.
	The printer cannot detect the paper properly.	If you are using special paper, the paper may not be fed into printer automatically. Feed the paper manually. ( <a href="#">"Feeding Paper into the Printer Manually" on page 72</a> )

Status	Cause	Solution
<p>Media Detection is Unstable</p> <p>Unstable conditions:</p> <ul style="list-style-type: none"> <li>• Print start position is inconsistent.</li> <li>• Some labels cannot be printed.</li> <li>• Paper is fed and ejected, and an error occurs.</li> <li>• A paper size error occurs even though the correct paper size is set.</li> </ul>	<p>The position of the gap detector may be incorrect.</p>	<p>Check that the detector adjustment tabs (light receiving and light emitting units) are in the same position and perform sensor calibration.</p> <p>How to align the gap detector position:  <a href="#">("Adjusting Gap Detector" on page 292)</a></p> <p>How to perform sensor calibration:  <a href="#">("Adjusting Sensitivity of the Detectors and Threshold for Detecting Labels" on page 291)</a></p>
<p>Paper is Fed and Ejected, and an Error Occurs</p> <p>Media Form: Continuous label (without black marks)</p>	<p>The paper being used differs from that of Media detection settings.</p>	<p>Check the paper being used and Media detection settings of the printer. ("<a href="#">Media Source and Media Detection Settings" on page 85</a>)</p>
<p>Paper is Fed and Ejected, and an Error Occurs</p> <p>Media Form: Die-cut label (Gap)</p>	<p>The paper being used differs from that of Media detection settings.</p>	<p>Check the paper being used and Media detection settings of the printer. ("<a href="#">Media Source and Media Detection Settings" on page 85</a>)</p>
	<p>The transmittance of the paper does not comply with the specifications.</p>	<p>If the transmittance of the paper differs, gaps may not be recognizable. Infrared light is used for gap detection, and the infrared transmittance of the backing paper needs to be the specified value or higher and the infrared transmittance of the label part needs to be the specified value or lower.</p> <p>Check the specifications of the paper, and use paper that complies with the printer specifications. ("<a href="#">Paper Specifications" on page 361</a>)</p> <p>The gaps may become recognizable by adjusting the label gap detector.</p> <p>On the operation panel, select [Menu] - [Maintenance] - [Calibration] - [Simple Media Detect] in that order. If the problem is not resolved, carry out [Media Detect].</p>
	<p>The sensor has failed.</p>	<p>If operation was normal up until now, the sensor has probably failed. Request repairs.</p>

Status	Cause	Solution
Paper is Fed and Ejected, and an Error Occurs	The paper being used differs from that of Media detection settings.	Check the paper being used and Media detection settings of the printer. (" <a href="#">Media Source and Media Detection Settings</a> " on page 85)
Media Form: Continuous Label (BlackMark), Die-cut Label (BlackMark)	The black marks do not comply with the specifications.	<p>If the reflectivity of the black marks is higher than the specified value, the black marks may not be recognizable. Infrared light is used for black mark detection, and the infrared reflectivity needs to be the specified value or lower.</p> <p>Check the specifications of black mark printing, and use black marks that comply with the printer specifications.</p> <p>The black marks may become recognizable by adjusting the black mark detector.</p> <p>On the operation panel, select [Menu] - [Maintenance] - [Calibration] - [Simple Media Detect] in that order. If the problem is not resolved, carry out [Media Detect].</p>
	The sensor has failed.	If operation was normal up until now, the sensor has probably failed. Request repairs.

## Network Connection Check Errors

Check the error number printed on the connection check report and take measures correspond to the error number.

For instructions on how to print the report, see ["Printing the Network Connection Check Report" on page 33](#).

Error number	Solution
E-1	<ul style="list-style-type: none"> <li>• Check that the LAN cable is securely connected to the printer and the other network devices such as a hub.</li> <li>• Check that the network device such as a hub is powered on.</li> </ul>
E-8	<ul style="list-style-type: none"> <li>• If you have set the printer's TCP/IP setting to auto, enable DHCP of the DHCP server.</li> <li>• If you have set the printer's TCP/IP manually, the IP address is out of the valid range, such as "0.0.0.0", and disabled. Set a valid IP address using the operation panel of the printer or using Web Config.</li> </ul>
E-9	<p>Check the followings.</p> <ul style="list-style-type: none"> <li>• Is the device that uses the printer turned on?</li> <li>• From the device that uses the printer, is it possible to access the Internet and connect to other computer or network devices on the same network?</li> </ul> <p>If there is no problem in the above checks, but the device or other network device still cannot connect to the printer via the network, configure the network settings again.</p>
E-10	<p>Check the followings.</p> <ul style="list-style-type: none"> <li>• Are other devices on the network turned on?</li> <li>• If you have set the printer's TCP/IP settings manually, is the network address (IP address, subnet mask, and default gateway) correct?</li> </ul> <p>If the network address is incorrect, correct it. You can check the IP address, subnet mask, and default gateway in the network settings column on the connection check report.</p> <p>If you have enabled DHCP, set the IP address to Auto in the printer's TCP/IP settings. If you want to set the IP address manually, check the printer's IP address in the network settings column on the connection check report, then set the address in the printer's network settings screen. Set the subnet mask to "255.255.255.0".</p>
E-11	<p>Check the followings.</p> <ul style="list-style-type: none"> <li>• If you have set the printer's TCP/IP settings manually, is the default gateway address correct?</li> <li>• Is the device specified for the default gateway turned on?</li> </ul> <p>Set the correct default gateway address. You can check the default gateway address in the network settings column on the connection check report.</p>

## A message is displayed on the computer screen

If the following screen appears, resolve the problem following the instructions on the screen.

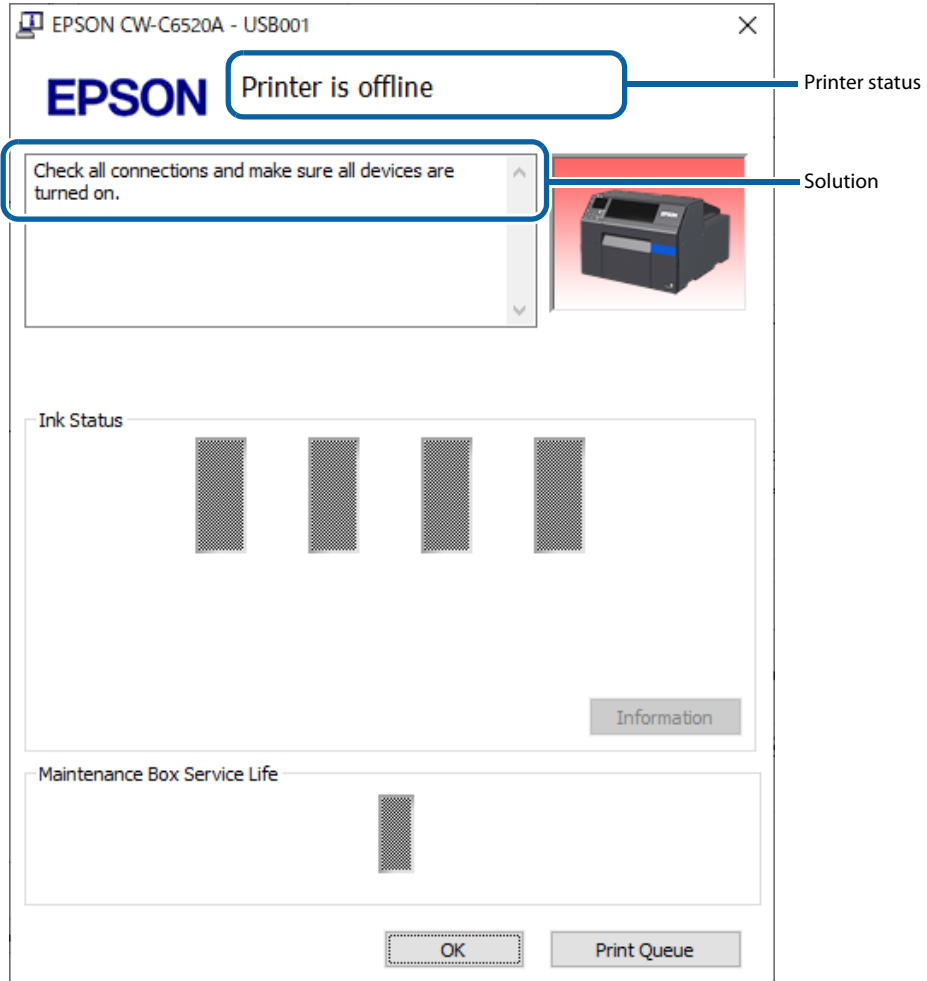

## Printing from a computer is impossible or becomes suddenly impossible

---

### Checking Whether the Printer Driver Is Installed

Check whether or not the required software and applications are installed on the computer.

To print with this printer, a printer driver is required. Check whether or not the printer driver is installed by following the steps below.

- 1 Display Devices and Printers on the computer.**
- 2 Check that the printer name is displayed.**  
If not, the printer driver is not installed.
- 3 Install the printer driver.**  
(["Printing the Network Connection Check Report" on page 33](#))

---

### Reconnecting the Printer and Computer

- 1 Check the cable connections.**  
Check that the power cable and the USB cable or wired LAN cable are connected properly.
- 2 Reconnect all of the devices.**  
For USB connection
  - Disconnect the USB cable and then reconnect it.
  - If the computer has multiple USB ports, connect the cable to a different port.For wired LAN connection
  - Device connected by wired LAN may have become unstable. Restart the network function.
  - Turn off the all devices.
  - Wait for about 10 seconds. Then turn on the devices from the networking device, the computer, and then the printer in that order.
- 3 Check that data is sent from the computer to the printer.**  
For the check procedure, see ["Checking the Print Data" on page 327](#).

---

### Checking the [Devices and Printers]

If the printer icon is not displayed in the [Devices and Printers] window, the printer device may have been deleted. Add the printer again following the procedure below.

- 1 Turn the printer off.**
- 2 Disconnect the USB cable from the computer.**

- 3** Wait for about 10 seconds, and then reconnect the USB cable to the computer.
- 4** Turn the printer on.  
The printer icon is now displayed in the [Devices and Printers] window.

---

## Checking the Print Data

If print data is not sent from a computer to the printer, it may be caused by print jobs remaining on the computer, or print jobs that has been paused or offline setting.

Check it following the procedure below.

- 1** Display Devices and Printers on the computer.
- 2** Set the printer as the default printer.  
Right-click the icon of the printer to be used and then click Set as default printer.  
If the printer is installed multiple times, copies of the printer driver may be created.  
If there is more than one printer icon and you find a copied one such as "CW-C6XXX (Copy 1)", right-click on the copied icon and then delete it by clicking Remove device.
- 3** Perform a test print to check whether or not the print data is sent to the printer.  
Right-click the icon of the printer being used and then click Printer properties.
- 4** The printer properties screen of the printer driver appears. Click Print Test Page on the General tab.  
If the test print is successful, you have confirmed that data is sent from the computer to the printer.
- 5** Display the print job. Right-click the icon of the printer being used and then click See what's printing.
- 6** A screen appears. Check the print job.  
If print data is displayed, select [Printer] - [Cancel All Documents].  
If the print data cannot be deleted, restart the computer.
- 7** Check "Pause Printing" or "Use Printer Offline" is not set for the printer.  
Select Printer and make sure that "Pause Printing" or "Use Printer Offline" is not checked. If any of them is checked, clear the check mark.

---

## The printer does not turn on



Check that the power cable is connected to the printer and outlet properly. (["Connecting the Power Cable" on page 38](#))

## Print Job is Canceled on PC but “Printing” Message on Printer Does Not Disappear

If you cancel printing in printer queue on the computer, it may cause the print data to break up and “Printing” may be kept displayed on the operation panel of the printer.

To cancel the status, press the Cancel button on the operation panel, and then select [All label formats].

## Error Beep Sound Does Not Stop

If the printer has been set to sound the error beep continuously, press the  (home) button or the  (back) button on the operation panel to stop the beep sound.

## Paper is jammed

This section describes how to resolve the problem when the paper is jammed. Videos that show the procedure are also available. Click the URL below to view the videos.

[https://support.epson.net/p\\_doc/790/](https://support.epson.net/p_doc/790/)

---

### For the Auto Cutter Model

- 1 Cut the paper near the paper ejection slot.

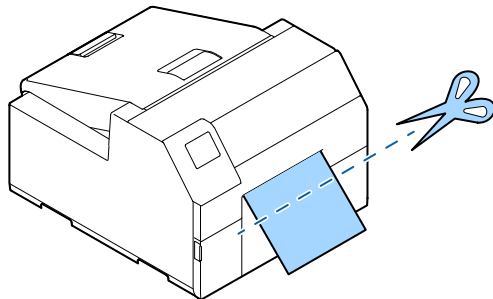

- 2 Open the front cover.

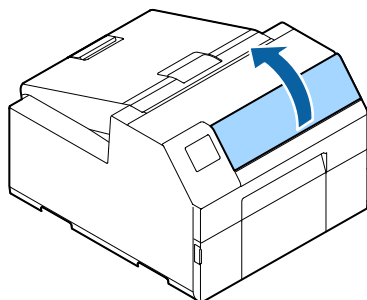

- 3** If there are ripped pieces of paper on the platen, remove them.

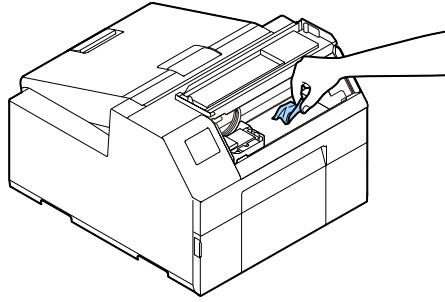

- 4** If the print head is not on the far right, hold it down and move it to the far right.  
If there is jammed paper on the position that the print head was stopped, remove it.

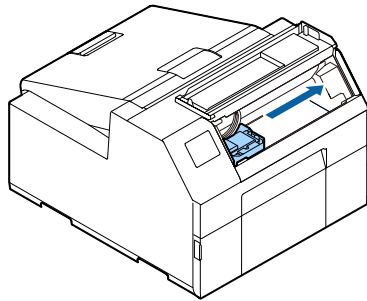

- 5** Raise the paper holder unit, and then remove any jammed paper.  
Do not touch the roller at the bottom of the paper holder unit with your hand. Doing so may cause injury. ("Caution Label" on page 10)

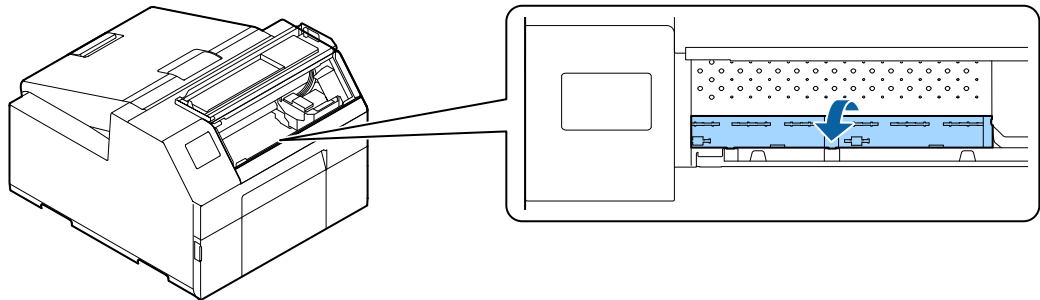

- 6** Lower the paper holder unit.

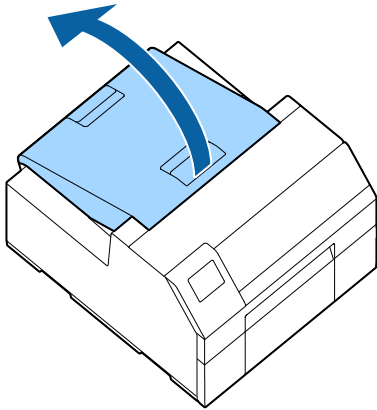
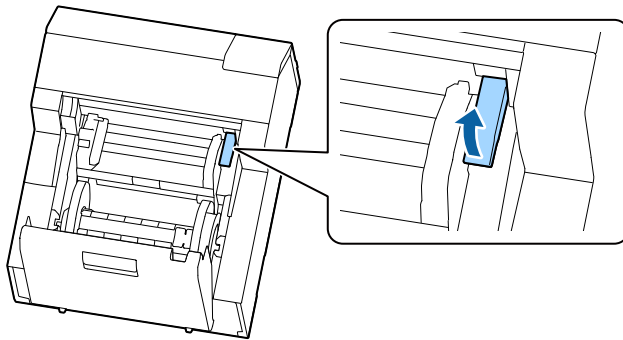
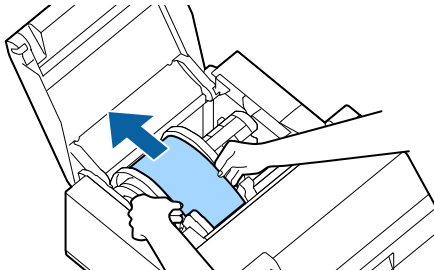
**7** Open the paper cover.**8** Raise the release lever.**9** Pull the paper out from the paper feed slot.**10** Remove the spindle, if present.

As shown in the figure, hold the spindle and flange with both hands, and remove them.

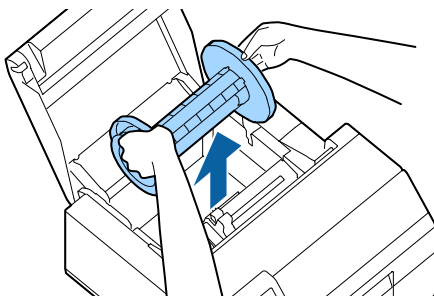

- 11** Raise the paper guide unit, and then remove any jammed paper from the inside.

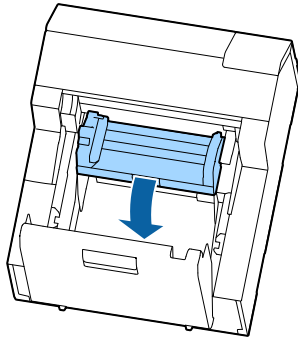

- 12** Close the paper guide unit.
- 13** Lower the release lever.
- 14** Close the paper cover.
- 15** Close the front cover.
- 16** Press the [Pause] button.  
The paper jam error will be cleared.

To resume printing, load the paper again.

(["How to Load Paper \(Auto Cutter Model - Supply from Inside\)"](#) on page 52, ["How to Load Paper \(Auto Cutter Model - Supply from Outside\)"](#) on page 56)



After removing jammed paper, make sure that there is no labels or adhesive left inside the printer.

If you use the printer without removing them, it leads to frequent paper jams, or may cause poor print quality.

If paper jam occurs frequently, clean the inside of the printer.

(["Cleaning the Printer"](#) on page 297)

## For the Peeler Model

- 1 Open the peeler cover.

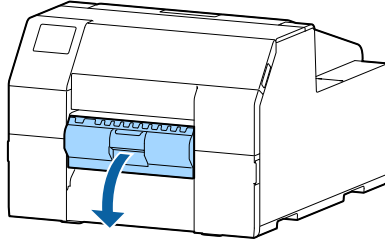

- 2 Cut the paper near the paper ejection slot.

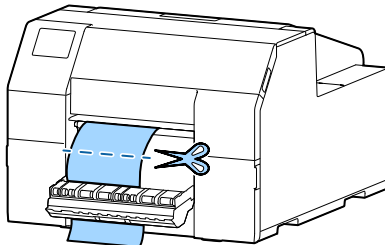

- 3 Open the front cover.

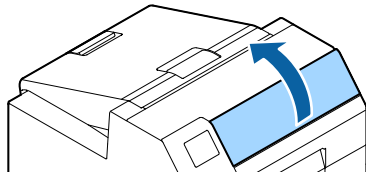

- 4 If there are ripped pieces of paper on the platen, remove them.

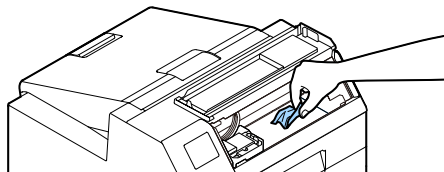

- 5 If the print head is not on the far right, hold it down and move it to the far right.  
If there is jammed paper on the position that the print head was stopped, remove it.

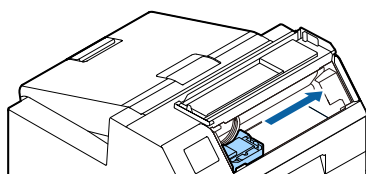

- 6** Raise the paper holder unit, and then remove any jammed paper.  
Do not touch the roller at the bottom of the paper holder unit with your hand. Doing so may cause injury. ("Caution Label" on page 10)

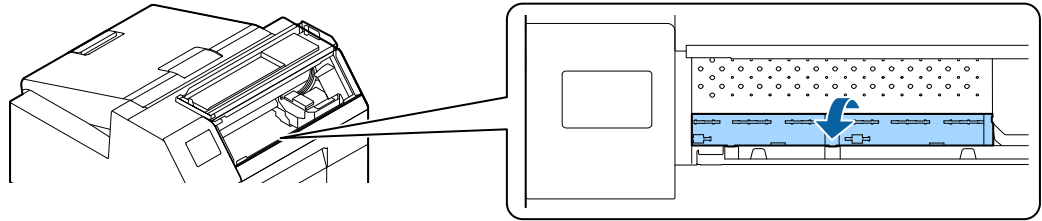

- 7** Lower the paper holder unit.

- 8** Open the paper cover.

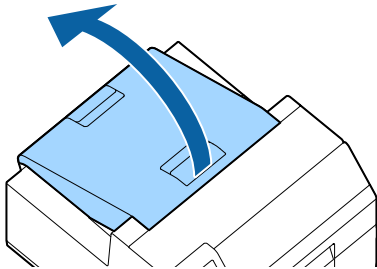

- 9** Raise the release lever.

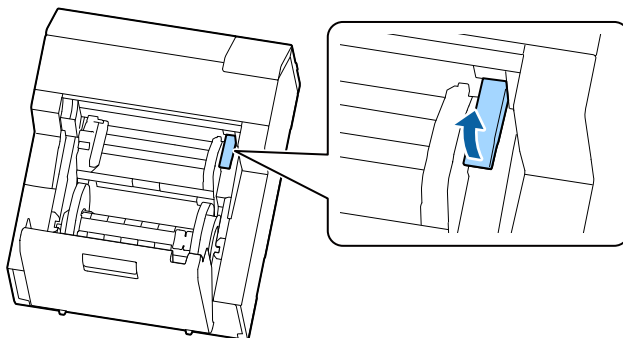

- 10** Pull the paper out from the paper feed slot.

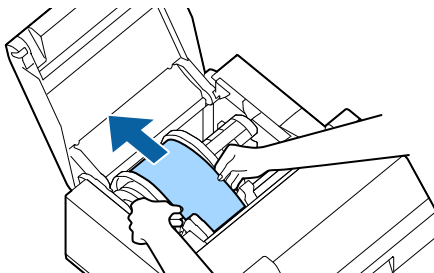

**11 Remove the spindle, if present.**

As shown in the figure, hold the spindle and flange with both hands, and remove them.

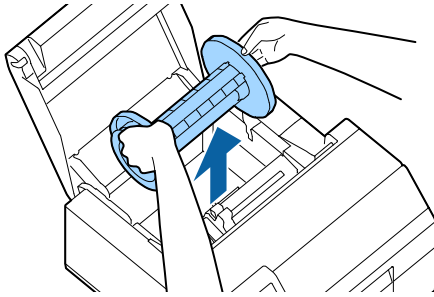
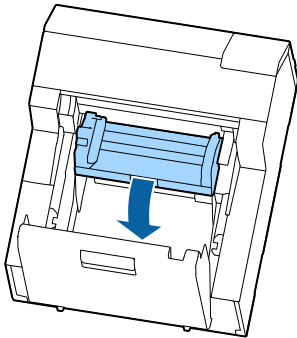
**12 Raise the paper guide unit, and then remove any jammed paper from the inside.****13 Close the paper guide unit.****14 Lower the release lever.****15 Close the paper cover.****16 Close the front cover.****17 Close the peeler cover.****18 Press the [Pause] button.**

The paper jam error will be cleared.

To resume printing, load the paper again.

(["How to Load Paper \(Peeler Model - Supply from Inside\)"](#) on page 60)



After removing jammed paper, make sure that there is no labels or adhesive left inside the printer.

If you use the printer without removing them, it leads to frequent paper jams, or may cause poor print quality.

If paper jam occurs frequently, clean the inside of the printer.

(["Cleaning the Printer"](#) on page 297)

# Information for Application Development

This chapter provides printer control methods and other information necessary for developing an application.

## *How to Control the Printer*

The printer control method differs depending on how to print from the printer.

<b>Application specifications</b>	<b>Printer control method</b>	<b>Page</b>
Print using the printer driver that is installed following the setup workflow described in chapter 2.	Use the printer driver.	<a href="#">Page 75</a>
Print using your application developed with reference to Epson Inkjet Label Printer SDK.	Use the Epson Inkjet Label Printer SDK commands.	<a href="#">Page 336</a>
Print using your application that directly controls ESC/Label commands.	Use the ESC/Label commands.	<a href="#">Page 337</a>
Print using an existing application and printer driver that were used for a ZPL II compatible monochrome printer. Change from preprint system to on-demand print system.	Change the printer settings to replace the printer.	<a href="#">Page 340</a>

## Using the Epson Inkjet Label Printer SDK

The SDK provides you an environment required for your application to print through the Epson printer driver. The followings are included.

Item	Description
Epson Inkjet Label Printer SDK User's Guide	Describes overview of Epson Inkjet Label Printer SDK configuration, functions required for controlling the Epson inkjet label printer from an application, how to use the sample programs, and printer driver settings that need to be configured in advance.
EPDI (EPSON Printer Driver Interface)	EPDI (EPSON Printer Driver Interface) provides application programming interfaces of Epson printer driver. By using the EPDI, you can configure the Epson printer driver settings from your application.  For details about EPDI and information necessary to use it on your application programming, see "EPDI for Inkjet Label Printer Reference Guide" included in this SDK.
EpsonNet SDK	EpsonNet SDK provides API commands to get status of Epson inkjet label printer. For details about the API and information necessary to use it on your application programming, see "EpsonNet SDK for Windows Reference Guide" included in this SDK.
Label Print Sample Program	Provides executable files and source files of the program that perform printing from Epson inkjet label printer using Epson Inkjet Label Printer SDK. For instructions on how to use the sample programs, see "Epson Inkjet Label Printer SDK User's Guide".

### Operating Environment

OS	Refer to the Appendix.
Software	Printer driver Please download it from the following website. For customers in North America, go to the following web site: <a href="https://www.epson.com/support/">https://www.epson.com/support/</a> For customers in other countries and regions, go to the following web site: <a href="https://epson.sn">https://epson.sn</a>

### How to Get Software

Contact qualified service personnel.

## Using the ESC/Label Commands

The ESC/Label commands allow you to print directly from your application without using the printer driver.

### How to Get Software

Please follow the instructions at the URL below.

For customers in North America, go to the following web site:

<https://www.epson.com/support/>

For customers in other countries and regions, go to the following web site:

<https://epson.sn>

## Replacing from ZPL II Compatible Monochrome Printer

If you want to print from the printer using an existing application and printer driver that were used for a ZPL II compatible monochrome printer, you need to change the printer settings so that they match with the settings of the ZPL II compatible monochrome printer.

### Changing from Two-Step Printing to One-Step Printing

CW-C6000/C6500 Series allow you to register an image file in png format to the printer, and print data sent from a host computer overlaying the registered image on the print data.

For example, if you had created color labels in two steps as described below, you can change it to one step without changing the system and data on the host computer.

Step 1. Purchasing label paper preprinted in color from a printing company.

Step 2. Printing monochrome data on the preprinted paper using ZPL II compatible monochrome printer.

#### Conventional Printing Method (Preprinting + Monochrome)

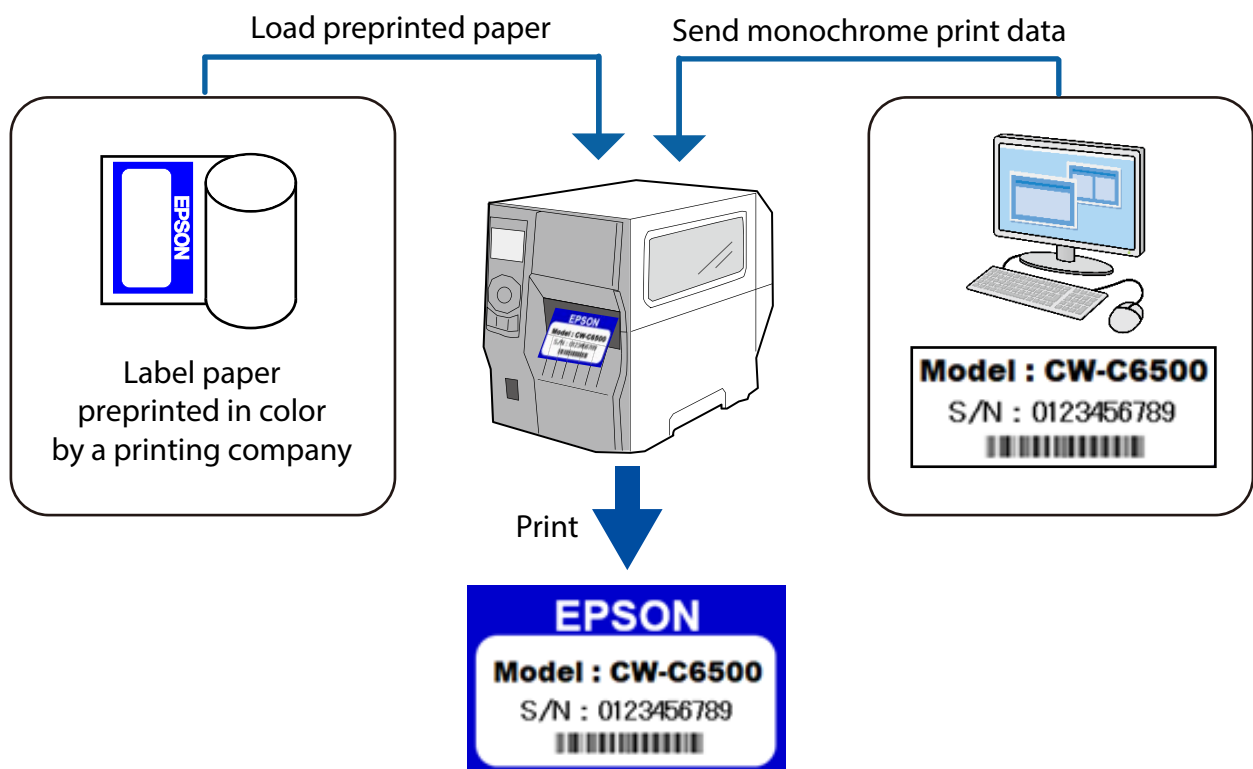

### One Step Printing Method with CW-C6000/C6500 Series

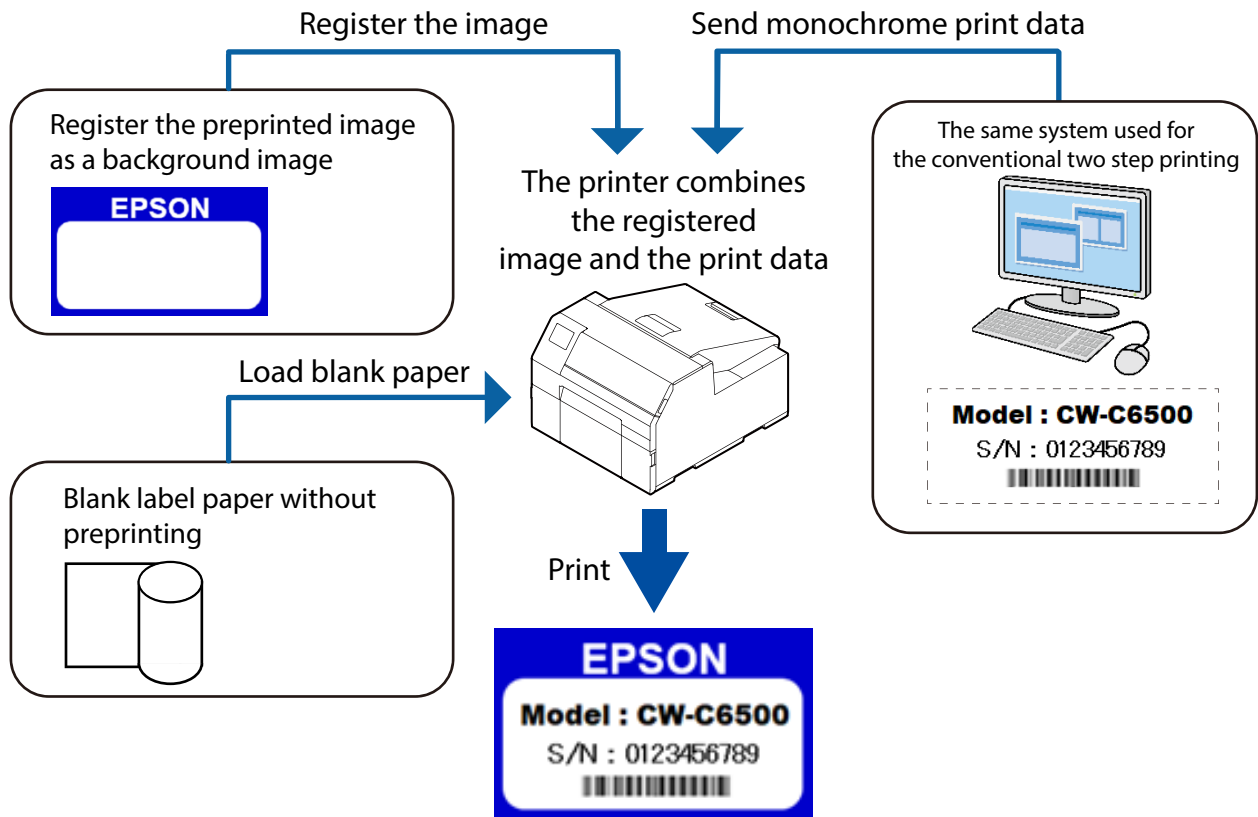

## Changing Printer Settings and Replacing Printer

Follow the flowchart below.

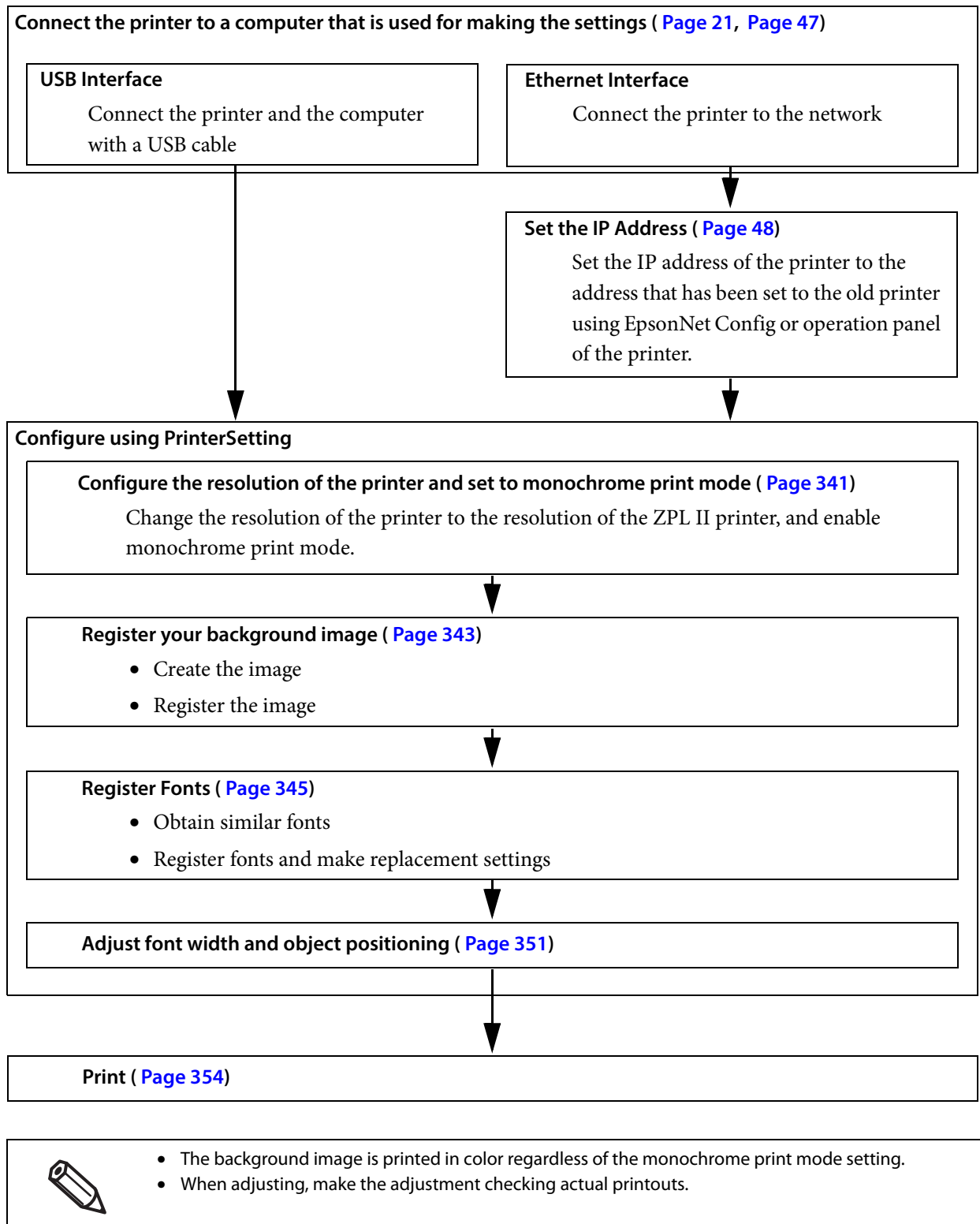

## Setting the Printer Resolution and Monochrome Print Mode

- 1 Start PrinterSetting.
- 2 Select [Advanced settings] from the [Detailed settings] menus, then click [Set...] beside the [Replace settings from printer using ZPL II commands:] option.

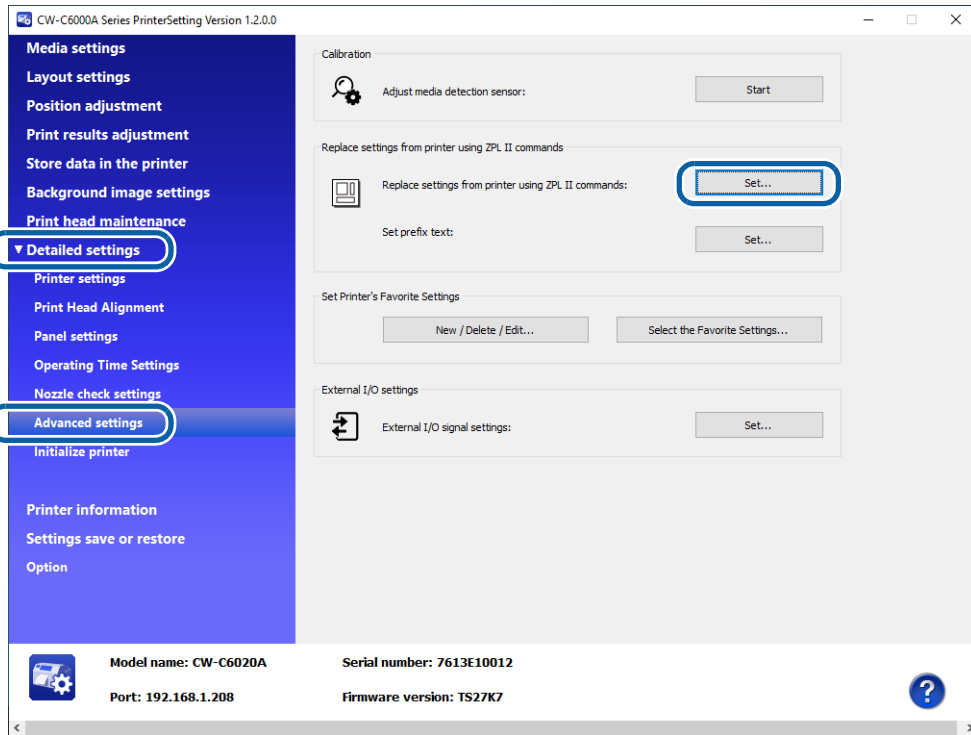

The "Replace settings from printer using ZPL II commands" window appears.

- 3** Select the resolution in the [Resolution of the printer in use:] pull-down menus. If the same resolution is not found in the menus, select one of the closest resolution. For example, if the resolution of the ZPL II compatible monochrome printer you were using is 203 dpi, select 200 dpi.

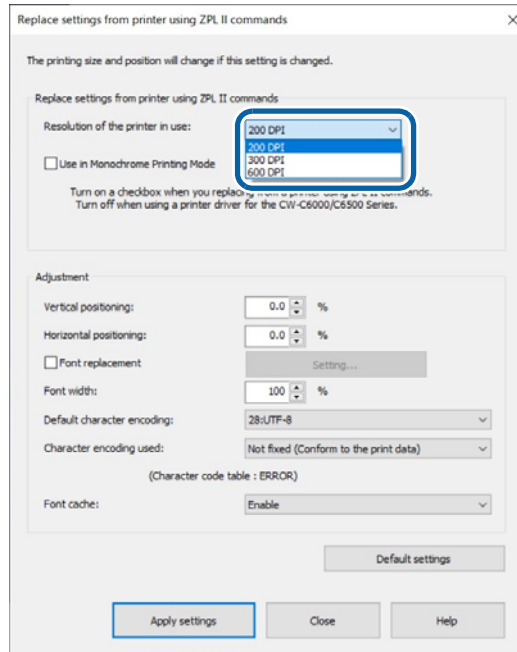

- 4** Select the checkbox for [Use in Monochrome Printing Mode] to print only in black and white and not print in color after replacing from the ZPL II compatible monochrome printer.

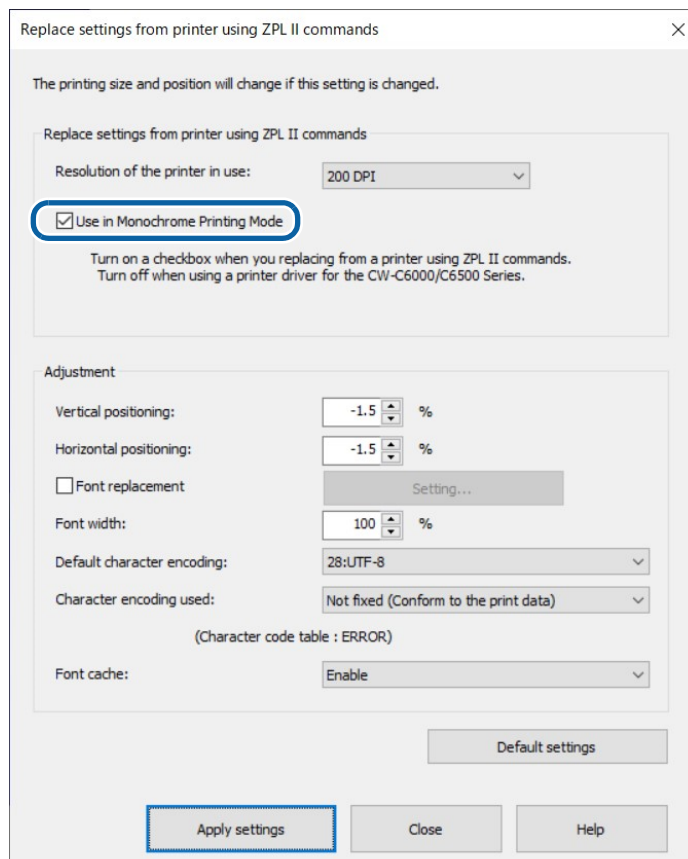

## Registering a Background Image

- 1** Create an images to be used as a background image.  
Use an image-editing software, save the background image in png format.  
Make sure to set the image resolution to 600 dpi.
- 2** Start PrinterSetting.
- 3** On the [Store data in the printer] window, click [Store...] in the [Image (Only .png)] field.  
The “Store image” window appears.
- 4** Specify the png image file to be stored, and then click [Set].

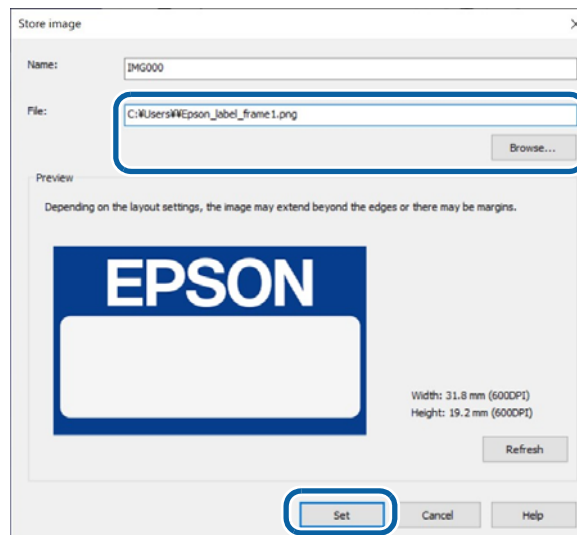

The image file is sent to the printer and stored as a background image.

- 5 On the [Background image settings] window, select the stored image to use in the [Set background image] field.

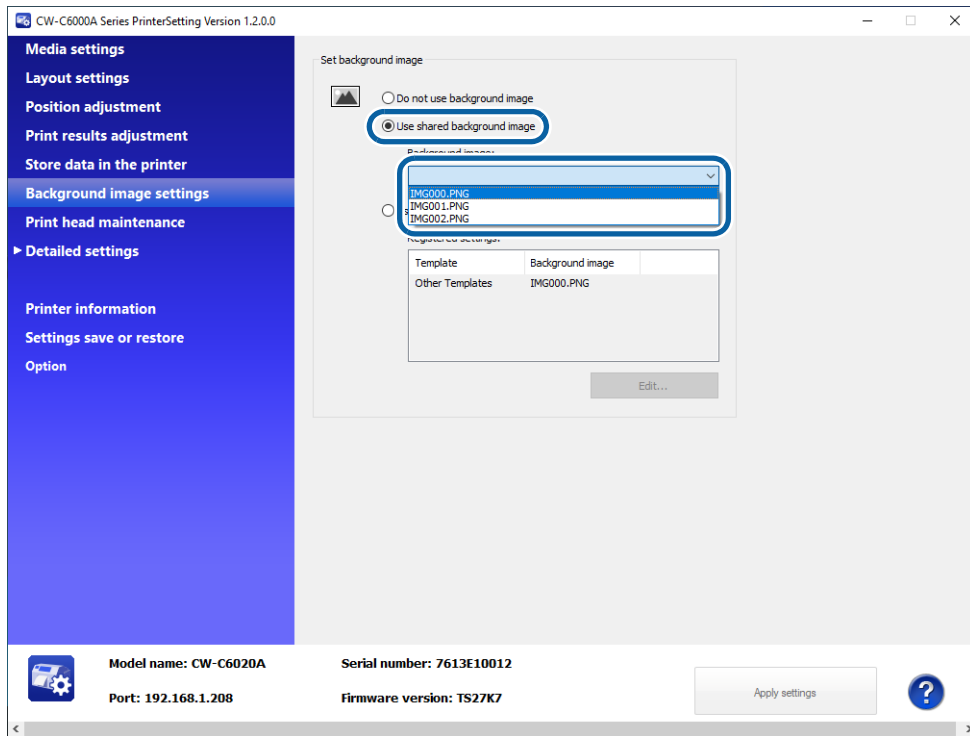

## Registering Fonts

### Font Registration Function

CW-C6000/C6500 Series and ZPL II compatible monochrome printers have built-in fonts. CW-C6000/C6500 Series have Epson original built-in fonts and they are different from the fonts on the ZPL II compatible monochrome printers.

Since the font style (shape and thickness) and space around the font (causes changes in character spacing) of printed characters depend on the type of the built-in font, there may be differences in print results between CW-C6000/C6500 Series and ZPL II compatible monochrome printers.

**Example:**

**Print results of ZPL II compatible monochrome printer**



**Print results of CW-C6000/C6500 Series**



To get print results close to the results of ZPL II compatible monochrome printer, CW-C6000/C6500 Series provide the functions to register fonts and replace fonts of the ZPL II printer with similar fonts.

### Getting Similar Fonts

Prepare fonts (file format is TTF) similar to the built-in fonts on the ZPL II compatible monochrome printer. There are the following fonts that are similar to the fonts on ZPL II compatible monochrome printers. Since there are lot of fonts that differ in character thickness and spacing, carefully choose optimum fonts. Please get fonts and their licenses on your own responsibility.

Similar Fonts (Typical Example)

Font Name	Type Examples
Swiss 721	Black, Black Condensed
Helvetica	Bold, Bold Condensed

## Registering/Replacing Fonts

- 1 Start PrinterSetting.
- 2 On the [Store data in the printer] window, click [Store...] in the [Font (Only .ttf and .tte)] field.

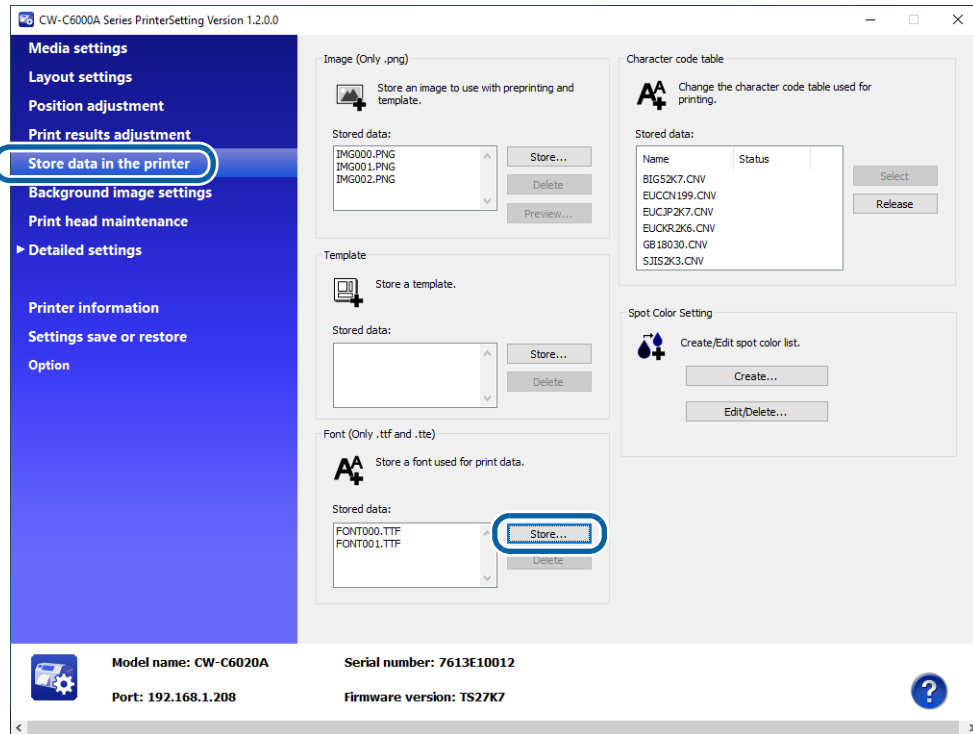

The "Store font" window appears.

- 3 Specify the font file (TTF format) to be stored, and then click [Set].**  
The font file is sent to the printer and stored as a built-in font.

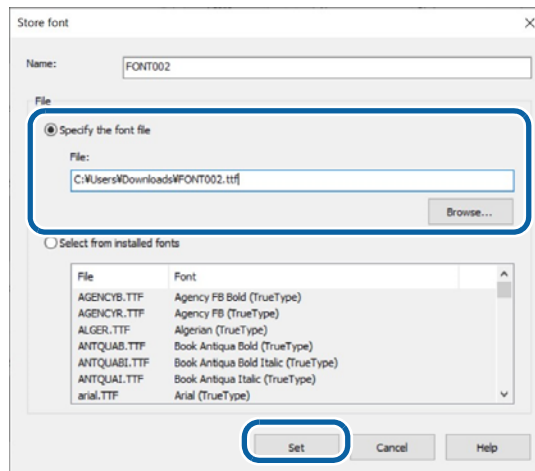

- 4 Select [Advanced settings] from the [Detailed settings] menus, then click [Set...] beside the [Replace settings from printer using ZPL II commands:] option.**

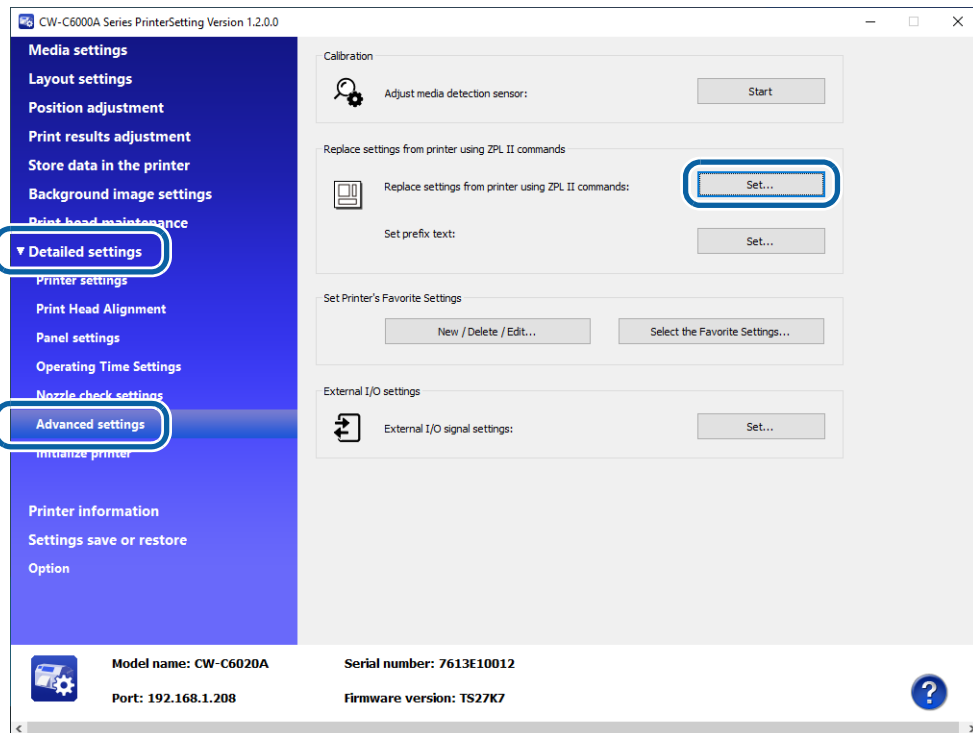

- 5** On the [Replace settings from printer using ZPL II commands] window, click [Settings] beside [Font replacement].

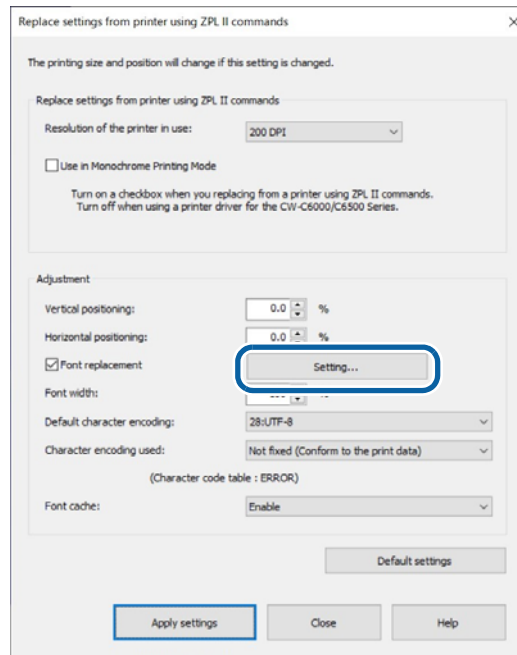

- 6** Select the font on the ZPL II compatible monochrome printer to be replaced by specifying the ID of the font.  
Select the ID from the list box.

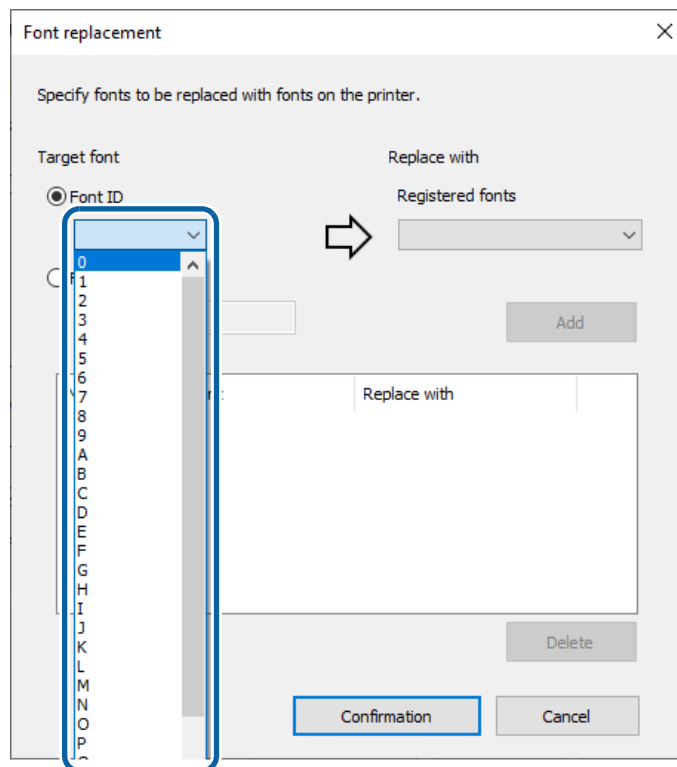

## 7 Select a font to be associated to the font ID.

Font replacement

Specify fonts to be replaced with fonts on the printer.

Target font

Font ID

0

Font name

Replace with

Registered fonts

FONT000.TTF

FONT000.TTF

FONT001.TTF

Add

No.	Target font	Replace with
-----	-------------	--------------

Delete

Confirmation

Cancel

- 8 Click [Add] to add the pair to the list in the window.  
Click [Confirmation] to save the list and go back to the “Replace settings from printer using ZPL II commands” window.

Font replacement

Specify fonts to be replaced with fonts on the printer.

Target font

Font ID

0

Font name

Replace with

Registered fonts

FONT000.TTF

Add

No.	Target font	Replace with
1	0	FONT000.TTF

Delete

Confirmation

Cancel

## 9 Select the check box for [Font replacement] to apply the font replacement settings.

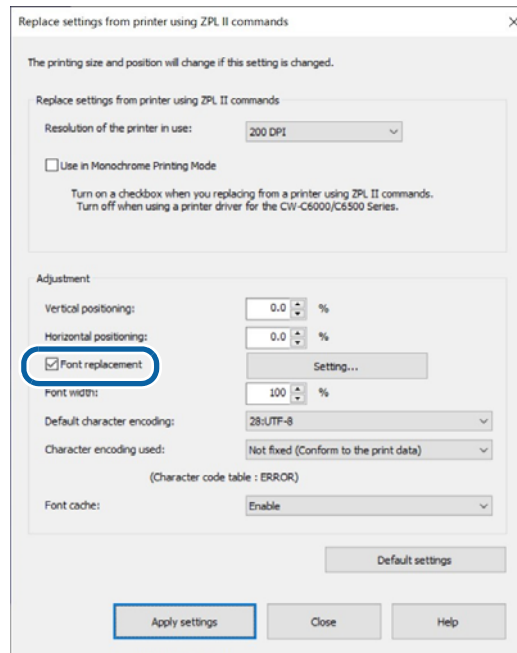

## 10 Click [Apply settings].

The settings are sent and set to the printer.

## Adjusting Font Width and Object Positioning

The following adjustments are provided in the [Replace settings from printer using ZPL II commands] window.

### Font width

This allows you to reduce width of font. “100%” is the original size. You can specify how much to reduce the width in increments of 1%. If you reduce the width too much, printed characters may become illegible. When you change the setting, check actual printouts. It is expected that the allowable range is 80 to 100%.

### Vertical Positioning

This allows you to adjust vertical print position of objects, such as a text, barcode, graphic, and image, in a label. The setting can be changed in the range of -5.0 to + 5.0% in increments of 0.1%.

### Horizontal Positioning

This allows you to adjust horizontal print position of objects, such as a text, barcode, graphic, and image, in a label. The setting can be changed in the range of -5.0 to + 5.0% in increments of 0.1%.

If CW-C6000/C6500 Series prints labels in 200 dpi, which had been printed in 203 dpi by the ZPL II compatible monochrome printer, the objects are printed being enlarged by 1.5% (203 divided by 200). Use the Vertical/Horizontal positioning functions to compensate position gaps caused by the difference in print resolution. Note that the positioning functions adjust only position of objects and do not change dimensions of the objects. This is to prevent the objects from being deformed. Especially for a thin line and barcode objects because scaling them down can result in disappearance of the line and drop in readability of the barcode.

In most cases, objects can be properly positioned with this functions, however, if there is a too large object comparing to the label size, or if gaps between multiple objects are too narrow, objects may be printed overlapping with each other resulting in printing labels different from the original label design.

### Objects on a label

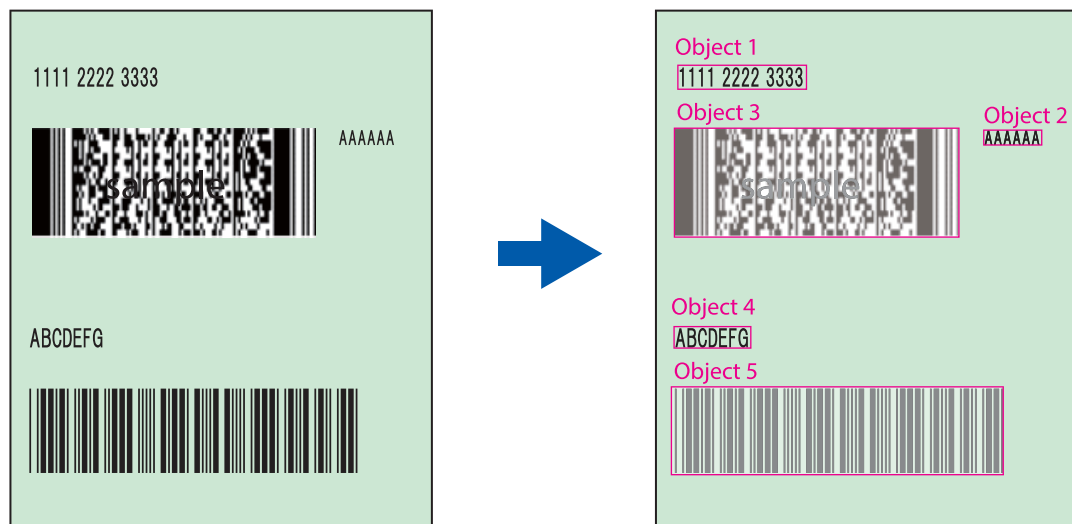

**Example when scaled down by 1.5% both vertically and horizontally with the positioning functions**

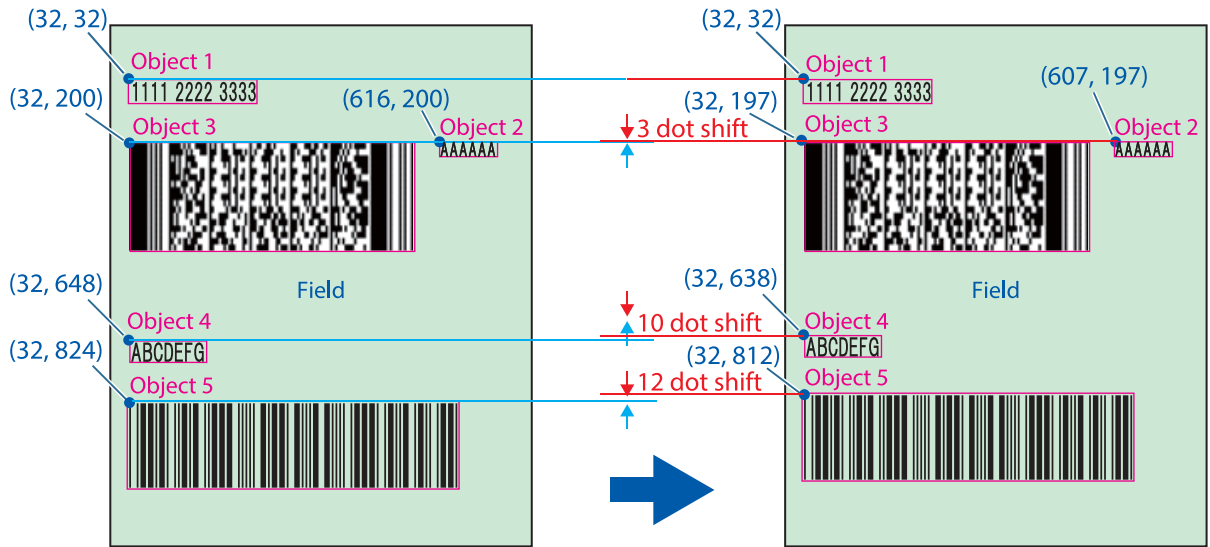

**Ex:** Object 2:  $616 \times 0.985 = 606.8$   
 $200 \times 0.985 = 197.0$   
 Object 4:  $32 \times 0.985 = 31.5$   
 $648 \times 0.985 = 638.3$

- 1 Start PrinterSetting.
- 2 Select [Advanced settings] from the [Detailed settings] menus, then click [Set...] beside the [Replace settings from printer using ZPL II commands:] option.

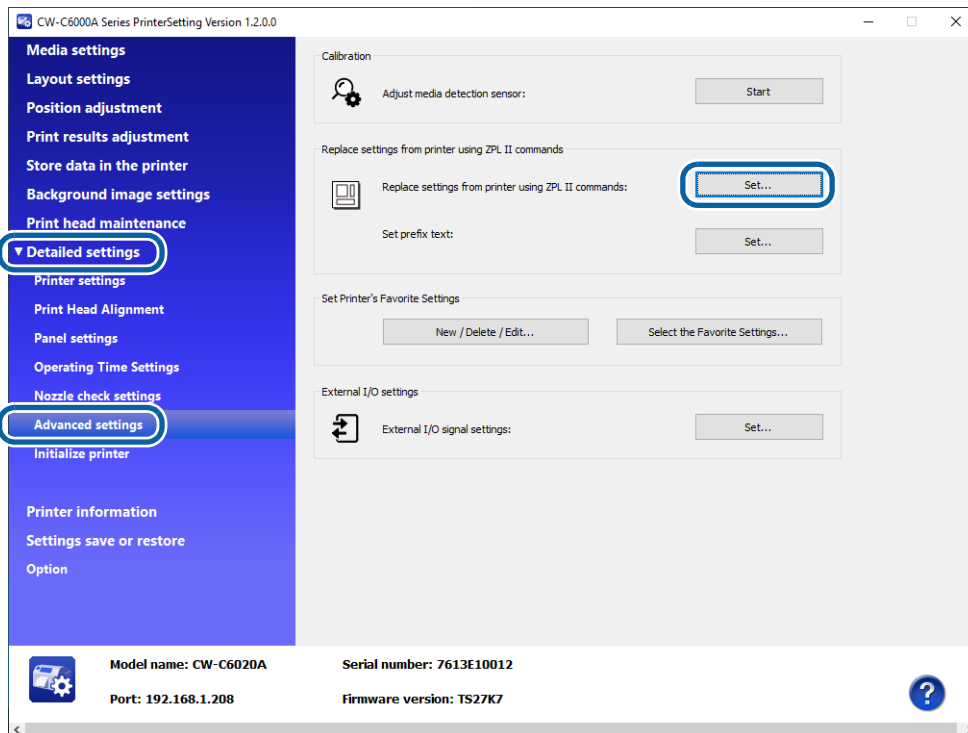

The "Replace settings from printer using ZPL II commands" window appears.

### 3 Select a value in each of the Vertical positioning and Horizontal positioning boxes.

If you have set the same resolution as the resolution of the ZPL II compatible monochrome printer, set "0" (zero) to both the [Vertical positioning] and [Horizontal positioning].

If the resolution of the ZPL II compatible monochrome printer you were using is 203 dpi, and you have set the resolution to 200 dpi, set "-1.5%" to both the [Vertical positioning] and [Horizontal positioning].

Replace settings from printer using ZPL II commands

The printing size and position will change if this setting is changed.

Replace settings from printer using ZPL II commands

Resolution of the printer in use: 200 DPI

Use in Monochrome Printing Mode

Turn on a checkbox when you replacing from a printer using ZPL II commands.  
Turn off when using a printer driver for the CW-C6000/C6500 Series.

Adjustment

Vertical positioning: -1.5 %

Horizontal positioning: -1.5 %

Font replacement Setting...

Font width: 100 %

Default character encoding: 28:UTF-8

Character encoding used: Not fixed (Conform to the print data)

(Character code table : ERROR)

Font cache: Enable

Default settings

Apply settings Close Help

If you do not adjust the font width, proceed to step 5.

## 4 Adjust the font width.

First set this to "100%", and then change it after checking actual print results.

Replace settings from printer using ZPL II commands

The printing size and position will change if this setting is changed.

Replace settings from printer using ZPL II commands

Resolution of the printer in use: 200 DPI

Use in Monochrome Printing Mode

Turn on a checkbox when you replacing from a printer using ZPL II commands.  
Turn off when using a printer driver for the CW-C6000/C6500 Series.

Adjustment

Vertical positioning: -1.5 %

Horizontal positioning: -1.5 %

Font replacement Setting...

Font width: 100 %

Default character encoding: 28:UTF-8

Character encoding used: Not fixed (Conform to the print data)

(Character code table : ERROR)

Font cache: Enable

Default settings

Apply settings Close Help

## 5 Click [Apply settings].

The settings are sent and set to the printer.

## Printing

Let the printer print under conditions where the printer is actually used, then check the print results.

## Utilizing Templates

If you have used templates with a monochrome thermal printer, you can register the template to CW-C6000/C6500 Series and use the templates from your application that directly controls ZPL II commands. For details, see ["Changing Printer Settings and Replacing Printer" on page 340](#).

Since the ESC/Label commands and ZPL II commands are different in supported range and template file extension, you need to change some commands in accordance with the ESC/Label command specifications. For more details about the ESC/Label command specifications, refer to the "ESC/Label Command Reference Guide".

The procedure is as follows.

### 1 Register the image. ( Page 197)

Register the image to the printer.

### 2 Register the template. ( Page 198)

Register the template to the printer.

If you use template files created by using the ZPL II commands, change the file extension so that the file is supported by the ESC/Label commands. In addition to that, delete commands that are not supported by the ESC/Label commands.

### 3 Link the template and the image. ( Page 202)

Configure the settings to link the template and the image.

### 4 Set the resolution. ( Page 216)

Select [Advanced settings] from the [Detailed settings] menus, then select [Replace settings from printer using ZPL II commands:] and set the resolution that is the same as the resolution of the monochrome thermal printer you were using.

### 5 Print the template.

To print labels using template files, change the file extension of the template file specified by the ZPL II commands in the application so that the file is supported by the ESC/Label commands.

The template specified by the ZPL II command in the application, variable information, and the image are combined and printed.

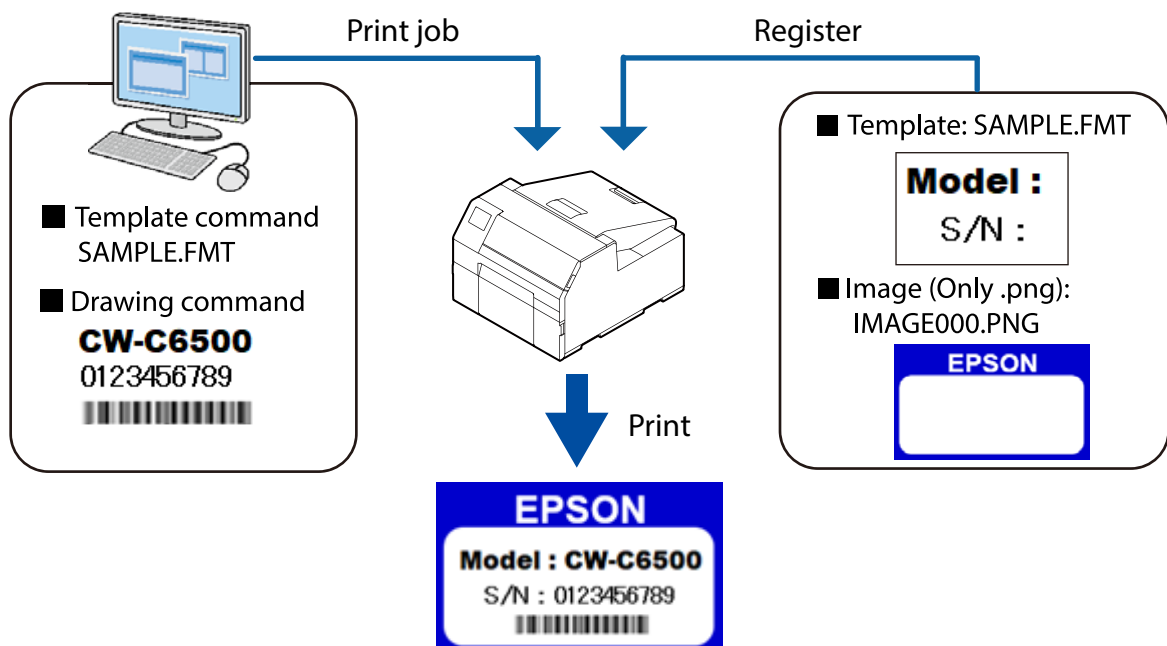

## Software and Manuals

The following pieces of software and manuals are provided.

### Software

Name	Description	Providing Method
Printer driver for Windows	Driver to print from Windows applications. The utility (CW-C6XXX PrinterSetting) for configuring the printer settings can be started from the driver. For details on how to use the driver, refer to Help or the video.	Web
Printer driver for Mac	Driver to print from Mac applications. For details on how to use the driver, refer to the driver's Help.	Web
Printer driver for Linux	Driver to print from a Linux application.	Web
EpsonNet Config SE	Tool to acquire or set network settings, such as TCP/IP of the product.	Web
Color Tone Matching Assistant	Assists you to adjust colors of illustrations or letters. You can check how a specific color used in illustrations or letters will look on printouts.	Web
SAP HVP Plugin	When using the SAP EH & S WWI HVP system to perform a large volume of printing on your network, you can use the HVP plug-in for EPSON CW-C6000/6500 Series to reduce server load and traffic in the network.	Web
Epson Device Admin	Epson Device Admin is multifunctional software that allows you to manage printers on a network. (" <a href="#">Epson Device Admin</a> " on page 245)	Web
USB Printer Class Device Replacement Service	When a USB device of the same model is replaced, this tool automatically changes the output destination to another printer driver without changing the application or OS settings.	Web

### Manual

Name	Description	Providing Method
Start Here	Guides you through basic setup steps from unpacking to loading paper.	<ul style="list-style-type: none"> <li>• Included in the printer package</li> <li>• Web</li> </ul>
User's Guide	Describes details about the functions and operating procedures of the product, maintenance information, and troubleshooting.	Web
CW-C6000 Series/ CW-C6500 Series Technical Reference Guide (This manual)	Provides information necessary for installing the product, performing daily tasks, and developing a system using the product.	Web

Name	Description	Providing Method
Maintenance box manual	Precautions on handling the maintenance box are described.	<ul style="list-style-type: none"> <li>• Included in the maintenance box package</li> <li>• Web</li> </ul>
CW-C6000 Series / C6500 Series External I/O Technical Reference Guide	Describes information necessary for development regarding extension interfaces.	Web
ESC/Label Command Reference Guide	This manual is common to all models. ESC/Label command specifications are explained.	Web
ESC/Label Command List	List of ESC/Label commands. The available commands and parameters are explained for each model.	Web
ESC/Label Application Development Guide	Explains how to print using the ESC/Label command and how to realize settings and maintenance functions for each model.	Web

# Appendix

## Product Specifications

Item		CW-C6000 Series	CW-C6500 Series		
Printing method		Serial inkjet, dot matrix method Four-color printing			
Paper feed method		Forward and reverse friction feed			
Cutting type of the auto cutter (Auto cutter model only)		Full cut (cuts paper completely)			
Print resolution		300 × 600 dpi, 600 × 600 dpi 600 × 1200 dpi, 1200 × 1200 dpi			
Print speed	Print quality setting: Max Speed 300 × 600 dpi (width × height)	Printing width	25.4 mm (1 inch)	156 mm (6.14 inches)/s	156 mm (6.14 inches)/s
			101.6 mm (4 inches)	119 mm (4.69 inches)/s	119 mm (4.69 inches)/s
			203.2 mm (8 inches)	-	85 mm (3.35 inches)/s
	Print quality setting: Speed 600 × 600 dpi (width × height)	Printing width	25.4 mm (1 inch)	125 mm (4.92 inches)/s	125 mm (4.92 inches)/s
			101.6 mm (4 inches)	75 mm (2.95 inches)/s	75 mm (2.95 inches)/s
			203.2 mm (8 inches)	-	49 mm (1.93 inches)/s
	Print quality setting: Normal 600 × 600 dpi (width × height)	Printing width	25.4 mm (1 inch)	63 mm (2.48 inches)/s	63 mm (2.48 inches)/s
			101.6 mm (4 inches)	48 mm (1.89 inches)/s	48 mm (1.89 inches)/s
			203.2 mm (8 inches)	-	34 mm (1.34 inches)/s
	Print quality setting: Quality 600 × 1200 dpi (width × height)	Printing width	25.4 mm (1 inch)	27 mm (1.06 inches)/s	27 mm (1.06 inches)/s
			101.6 mm (4 inches)	18 mm (0.71 inches)/s	18 mm (0.71 inches)/s
			203.2 mm (8 inches)	-	13 mm (0.51 inches)/s
Print quality setting: Max Quality 1200 × 1200 dpi (width × height)	Printing width	25.4 mm (1 inch)	11 mm (0.43 inches)/s	11 mm (0.43 inches)/s	
		101.6 mm (4 inches)	8 mm (0.31 inches)/s	8 mm (0.31 inches)/s	
		203.2 mm (8 inches)	-	6 mm (0.24 inches)/s	

Item		CW-C6000 Series	CW-C6500 Series
Interface		Wired LAN (1000BASE-T/100BASE-TX / 10BASE-T) USB2.0 High-Speed	
Weight	Auto cutter model	Approx. 22.5 kg (49.60 lb)	Approx. 25.5 kg (56.22 lb)
	Peeler model	Approx. 22.8 kg (50.27 lb)	Approx. 26.3 kg (57.98 lb)

## Relationship Between "Print Resolution" and "Resolution Settings"

"Print resolution" and "resolution settings" are defined differently for this product. See the following when configuring settings.

### Definition of Print Resolution

- This indicates the resolution of the printer's print results.
- The "print resolution" is automatically determined by the "Print Quality" setting.

Setting of print quality*	Print resolution (Paper width direction × Paper feed direction)	Print speed	Quality of print results
Max Speed	300×600 dpi	Fast	Low
Speed	600×600 dpi	↑	↑
Normal	600×600 dpi	↕	↕
Quality	600×1200 dpi	↓	↓
Max Quality	1200×1200 dpi	Slow	High

\*Setting value options vary depending on the paper type and ink specifications in use.

### Resolution Setting

The resolution setting refers to the setting that is used to specify the resolution for the printer being replaced, when replacing a monochrome thermal printer or similar printer with a ColorWorks printer.

Example: Print resolution for the printer being replaced: 200 dpi

Resolution setting for ColorWorks printer: 600 dpi

If the above conditions are used when replacing a printer, the ColorWorks printer will print a smaller image unless the 200 dpi resolution of for the printer being replaced is specified.

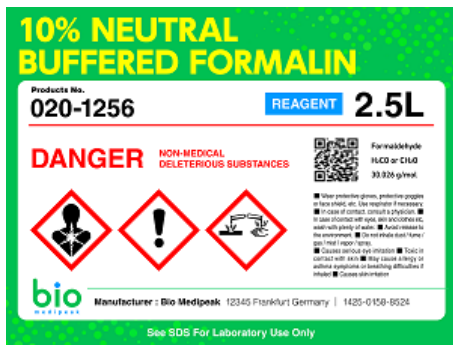

Printed image with 200 dpi printer



Printed image when set to 600 dpi

Use the operation panel or PrinterSetting to set [Resolution Setting] to the print resolution for the printer being replaced.

Example: Relationship between the print resolution for the printer being replaced and "Resolution Setting"

Print resolution for the printer being replaced	Resolution setting for ColorWorks printer
200–203 dpi	200 dpi
300 dpi	300 dpi
600 dpi	600 dpi

## Operating Environment

Support OS	Windows 11 Windows 10 (32 bit/ 64 bit) Windows 8.1 (32 bit/ 64 bit) Windows 8 (32 bit/ 64 bit) Windows 7 SP1 (32 bit/ 64 bit) Windows Vista SP2 (32 bit/ 64 bit) Windows Server 2022 Windows Server 2019 Windows Server 2016 Windows Server 2012 R2 Windows Server 2012 Windows Server 2008 R2 SP1 Windows Sever 2008 SP2 (32/64bit) Mac OS 10.6.8 or later, macOS 11 or later
Operation confirmed OS	Linux CentOS 7 (x86_64) Linux Ubuntu18.04 (x86_64)
Computer	The following computer that runs one of the above operating systems must be supported. PC/AT compatible machine
CPU	A computer that has Pentium 4 2 GHz or higher processor is recommended.
Memory	1 GB or more is recommended.
HDD	At least 250 MB is required.



- The above requirements may not satisfy the minimum system requirements of the supported operating systems. In that case, satisfy the minimum system requirements of the operating system.
- Epson confirmed the operations for the OS Distributions described above.  
Due to the large number of distributions and versions of Linux, Epson does not guarantee operation on any particular OS distribution or version.  
Other OS versions and Distributions not described above, users should confirm the operations by themselves.

## Paper Specifications

The paper that can be used with this printer are as follows.

Use the paper that is supported by the black ink you are using. If you use paper that is not supported by the black ink you are using, ink smear, bleeding, blurring, or faint print may occur.

Black Ink type	Supported paper
Gloss black ink	Matte Paper Synthetic Glossy Paper Glossy Film High Glossy paper
Matte black ink	Plain Paper Matte Paper Synthetic Texture Paper



- If you use paper that does not satisfy the required specifications, it may cause paper jams or lead to a drop of paper feed accuracy, barcode readability, and print quality.
- Do not paste or tape the end edge of roll paper to the core. Otherwise, the printer will fail to detect the end of the paper resulting in wasting multiple labels on the roll paper.
- If you are using synthetic labels with backing sheet made of paper, or labels with polyethylene laminated backing sheet, paper curl may occur depending on storage and usage environmental conditions. It occurs because the degree of expansion and contraction due to heat and moisture varies between the plastic materials, such as the synthetic and polyethylene, and the paper materials. If you use the curled paper, the paper may be rubbed against the print head causing ink smear on printouts or paper jams.
- Do not use paper sheets connected to each other with pieces of tape or other material. If you use the connected paper, the seams may cause false detection, or the paper may be rubbed against the print head causing ink smear on printouts or paper jams.
- When using matte black ink, if you touch label surface immediately after printing, ink may adhere to your fingers.
- The printer may not be able to detect the paper correctly depending on the paper material and the condition of the black marks. Please verify the paper well before using it.

<b>CW-C6000 Series</b>			Without perforation		With perforation	
	Paper shape	Form of paper (label)	With black marks	Without black marks	With black marks	Without black marks
Auto cutter model	Roll paper	Die-cut label	<a href="#">page 363</a>	<a href="#">page 365</a>	<a href="#">page 366</a>	<a href="#">page 368</a>
		Continuous label	<a href="#">page 370</a>	<a href="#">page 372</a>	-	-
	Fanfold paper	Die-cut label	-	-	<a href="#">page 373</a>	-
		Continuous label	-	-	-	-
Peeler model	Roll paper	Die-cut label	<a href="#">page 375</a>	<a href="#">page 377</a>	-	-
		Continuous label	-	-	-	-
	Fanfold paper	Die-cut label	-	-	-	-
		Continuous label	-	-	-	-

<b>CW-C6500 Series</b>			Without perforation		With perforation	
	Paper shape	Form of paper (label)	With black marks	Without black marks	With black marks	Without black marks
Auto cutter model	Roll paper	Die-cut label	<a href="#">page 378</a>	<a href="#">page 380</a>	<a href="#">page 381</a>	<a href="#">page 383</a>
		Continuous label	<a href="#">page 385</a>	<a href="#">page 387</a>	-	-
	Fanfold paper	Die-cut label	-	-	<a href="#">page 388</a>	-
		Continuous label	-	-	-	-
Peeler model	Roll paper	Die-cut label	<a href="#">page 390</a>	<a href="#">page 392</a>	-	-
		Continuous label	-	-	-	-
	Fanfold paper	Die-cut label	-	-	-	-
		Continuous label	-	-	-	-

## CW-C6000 Series (4-inch auto cutter model)

### Roll Die-cut Label (Black Mark)

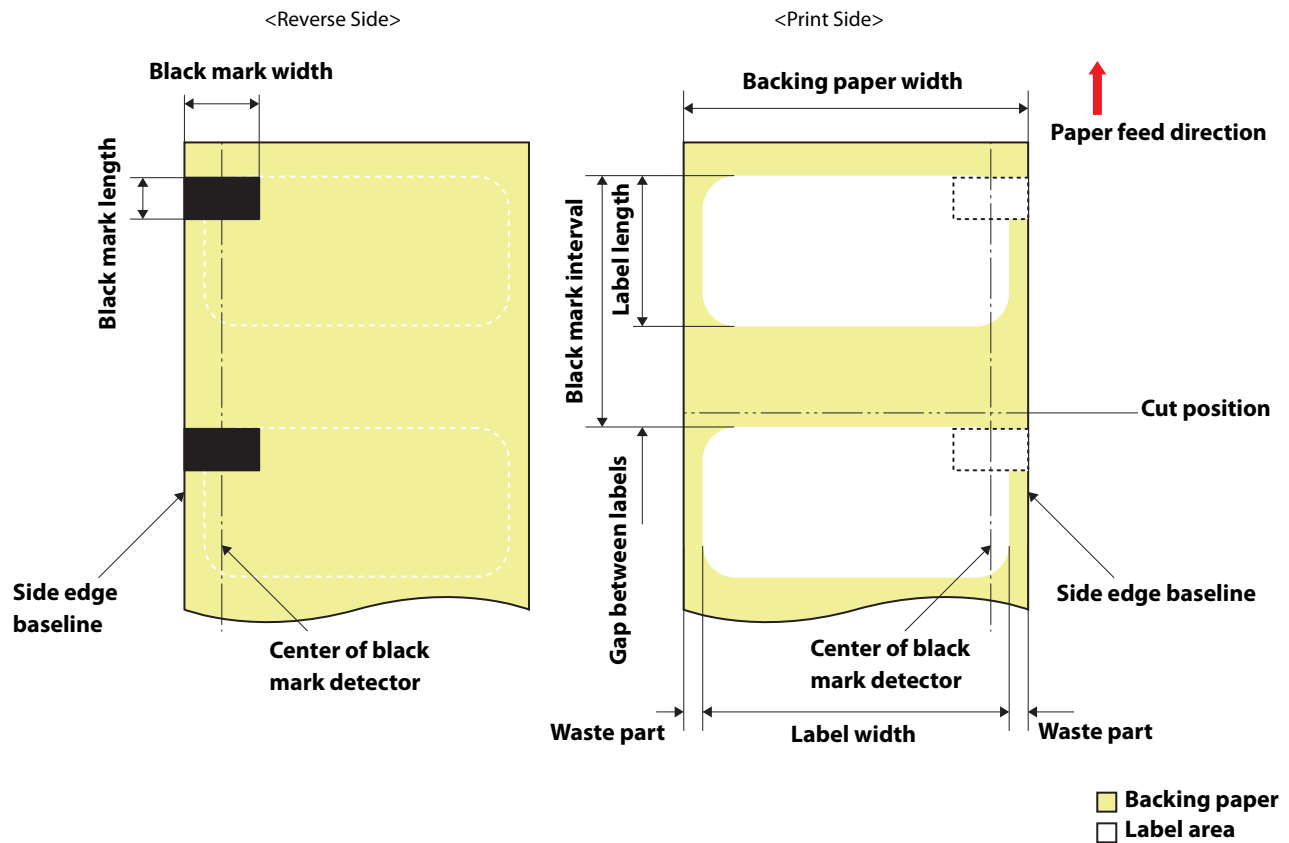

Form	Roll paper
Backing paper width	25.4 to 112 mm (1 to 4.41 inches)
Label width	21.4 to 108 mm (0.84 to 4.25 inches)
Label length	When auto cut is not used: 8 to 609.6 mm (0.31 to 24 inches) (up to 24 inches) When auto cut is used: 15 to 609.6 mm (0.59 to 24 inches) (up to 24 inches)
Gap between Labels	When auto cut is not used: 2 to 6 mm (0.08 to 0.24 inches) When auto cut is used: 2.5 to 6 mm (0.1 to 0.24 inches)
Waste part on the left and right	$2 \pm 0.5$ mm ( $0.08 \pm 0.02$ inches)
Label corner R	1.5 mm (0.06 inches) or less
Paper thickness	Plain Paper/Matte Paper/Synthetic/Texture Paper/Glossy Paper/Glossy Film/ High Glossy Paper 0.12 to 0.24 mm (0.005 to 0.009 inches)
Roll paper core inner diameter	$76.2 \pm 0.5$ mm ( $3 \pm 0.02$ inches)
Roll paper outer diameter	203.2 mm (8 inches) or less
Winding direction	Print side must be facing outside (facing inside is unusable)

Black mark position	Each black mark should extend at least 18.4 mm (0.72 inches) from side edge baseline.
Black mark width	18.4 mm (0.72 inches) or more
Black mark length	4 to 25.4 mm (0.16 to 1 inch), 4 mm (0.16 inches) or more of blank space on label
Black mark interval*1	When auto cut is not used: 10 to 615.6 mm (0.39 to 24.24 inches) When auto cut is used: 17.5 to 615.6 mm (0.69 to 24.24 inches)

\*1: It is not allowed to have another black mark in the intervening space between the black marks (black mark interval).



- Labels and backing paper with holes or cutouts cannot be used.
- Set the cut position to a position at least 1.7 mm (0.07 inches) away from the black mark of the next label.
- Set the start position of the first label to a position at least 1.5 mm (0.06 inches) away from the leading edge of the backing paper.

### Roll Die-cut Label (without Black Mark)

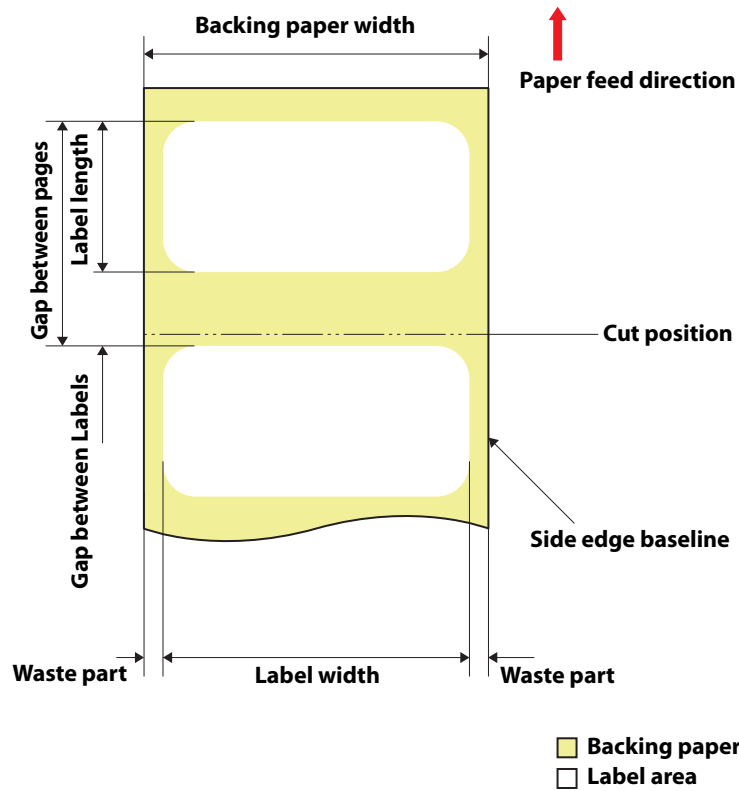

Form	Roll paper
Backing paper width	25.4 to 112 mm (1 to 4.41 inches)
Label width	21.4 to 108 mm (0.84 to 4.25 inches)
Label length	When auto cut is not used: 8 to 609.6 mm (0.31 to 24 inches) (up to 24 inches) When auto cut is used: 15 to 609.6 mm (0.59 to 24 inches) (up to 24 inches)
Gap between Labels	2 to 6 mm (0.08 to 0.24 inches)
Waste part on the left and right	2 ± 0.5 mm (0.08 ± 0.02 inches)
Label corner R	1.5 mm (0.06 inches) or less
Paper thickness	Plain Paper/Matte Paper/Synthetic/Texture Paper/Glossy Paper/Glossy Film/ High Glossy Paper 0.12 to 0.24 mm (0.005 to 0.009 inches)
Roll paper core inner diameter	76.2 ± 0.5 mm (3 ± 0.02 inches)
Roll paper outer diameter	203.2 mm (8 inches) or less
Winding direction	Print side must be facing outside (facing inside is unusable)

- 
- Labels and backing paper with holes or cutouts cannot be used.
  - Set the cut position to a position at least 0.7 mm (0.03 inches) away from the leading edge of the next label.
  - Set the start position of the first label to a position at least 1.5 mm (0.06 inches) away from the leading edge of the backing paper.

## Roll paper Die-cut Label with perforation (Black Mark)

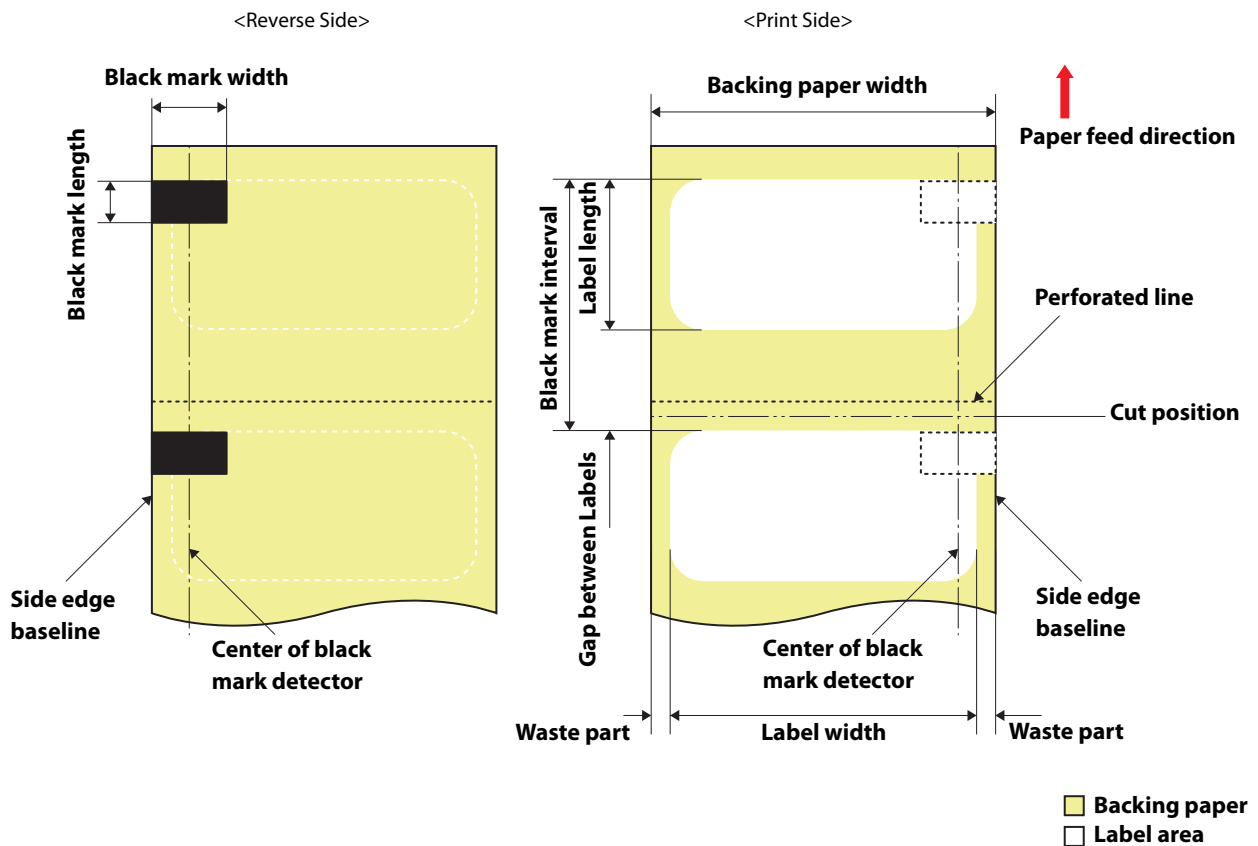

Form	Roll paper
Backing paper width	25.4 to 112 mm (1 to 4.41 inches)
Label width	21.4 to 108 mm (0.84 to 4.25 inches)
Label length	When auto cut is not used: 8 to 609.6 mm (0.31 to 24 inches) (up to 24 inches) When auto cut is used: 15 to 609.6 mm (0.59 to 24 inches) (up to 24 inches)
Gap between Labels	When auto cut is not used: 2 to 6 mm (0.08 to 0.24 inches) When auto cut is used: 3 to 6 mm (0.12 to 0.24 inches)
Waste part on the left and right	$2 \pm 0.5$ mm ( $0.08 \pm 0.02$ inches)
Label corner R	1.5 mm (0.06 inches) or less
Paper thickness	Plain Paper/Matte Paper/Synthetic/Texture Paper/Glossy Paper/Glossy Film/ High Glossy Paper 0.12 to 0.24 mm (0.005 to 0.009 inches)
Roll paper core inner diameter	$76.2 \pm 0.5$ mm ( $3 \pm 0.02$ inches)
Roll paper outer diameter	203.2 mm (8 inches) or less
Winding direction	Print side must be facing outside (facing inside is unusable)
Black mark position	Each black mark should extends at least 18.4 mm (0.72 inches) from side edge baseline.

Black mark width	18.4 mm (0.72 inches) or more
Black mark length	4 to 25.4 mm (0.16 to 1 inch), 4 mm (0.16 inches) or more of blank space on label
Black mark interval*1	When auto cut is not used: 10 to 615.6 mm (0.39 to 24.24 inches) When auto cut is used: 18 to 615.6 mm (0.7 to 24.24 inches)
Perforation interval	Three (hole portion) to one (no hole portion)
Perforation form	Usable if a hole is located at side edges

\*1: It is not allowed to have another black mark in the intervening space between the black marks (black mark interval).



- Labels and backing paper with holes or cutouts cannot be used.
- Auto cutting on the perforated lines will generate scraps of paper that may cause problems. Also, auto cutting ahead of the perforated line may cause problems when feeding paper. Therefore, perform auto cutting when paper is fed at least 0.8 mm (0.03 inches) away from the perforated line.
- Set the black mark position to a position at least 2.5 mm (0.1 inches) away from the perforated line.
- Set the cut position to a position at least 1.7 mm (0.07 inches) away from the black mark of the next label.
- Set the start position of the first label to a position at least 1.5 mm (0.06 inches) away from the leading edge of the backing paper.

## Roll paper Die-cut Label with perforation (without black marks)

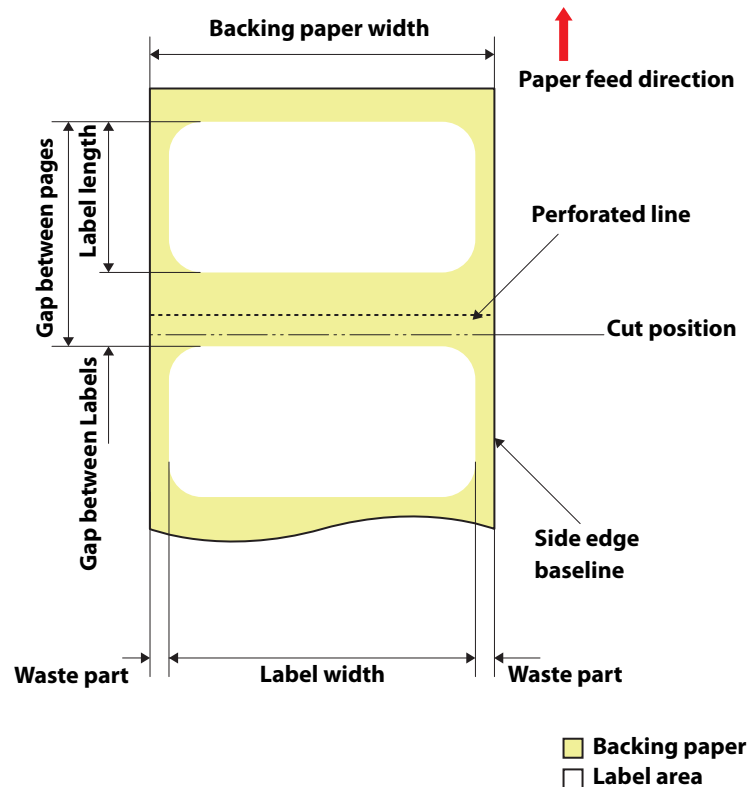

Form	Roll paper
Backing paper width	25.4 to 112 mm (1 to 4.41 inches)
Label width	21.4 to 108 mm (0.84 to 4.25 inches)
Label length	When auto cut is not used: 8 to 609.6 mm (0.31 to 24 inches) (up to 24 inches) When auto cut is used: 15 to 609.6 mm (0.59 to 24 inches) (up to 24 inches)
Gap between Labels	When auto cut is not used: 2 to 6 mm (0.08 to 0.24 inches) When auto cut is used: 3 to 6 mm (0.12 to 0.24 inches)
Waste part on the left and right	$2 \pm 0.5$ mm ( $0.08 \pm 0.02$ inches)
Label corner R	1.5 mm (0.06 inches) or less
Paper thickness	Plain Paper/Matte Paper/Synthetic/Texture Paper/Glossy Paper/Glossy Film/ High Glossy Paper 0.12 to 0.24 mm (0.005 to 0.009 inches)
Roll paper core inner diameter	$76.2 \pm 0.5$ mm ( $3 \pm 0.02$ inches)
Roll paper outer diameter	203.2 mm (8 inches) or less
Winding direction	Print side must be facing outside (facing inside is unusable)
Perforation interval	Three (hole portion) to one (no hole portion)
Perforation form	Usable if a hole is located at side edges



- Labels and backing paper with holes or cutouts cannot be used.
- Auto cutting on the perforated lines will generate scraps of paper that may cause problems. Also, auto cutting ahead of the perforated line may cause problems when feeding paper. Therefore, perform auto cutting when paper is fed at least 0.8 mm (0.03 inches) away from the perforated line.
- Set the leading edge of the next label to a position at least 1.5 mm (0.06 inches) away from the perforated line.
- Set the cut position to a position at least 0.7 mm (0.03 inches) away from the leading edge of the next label.

### Roll paper Continuous Label (Black Mark)

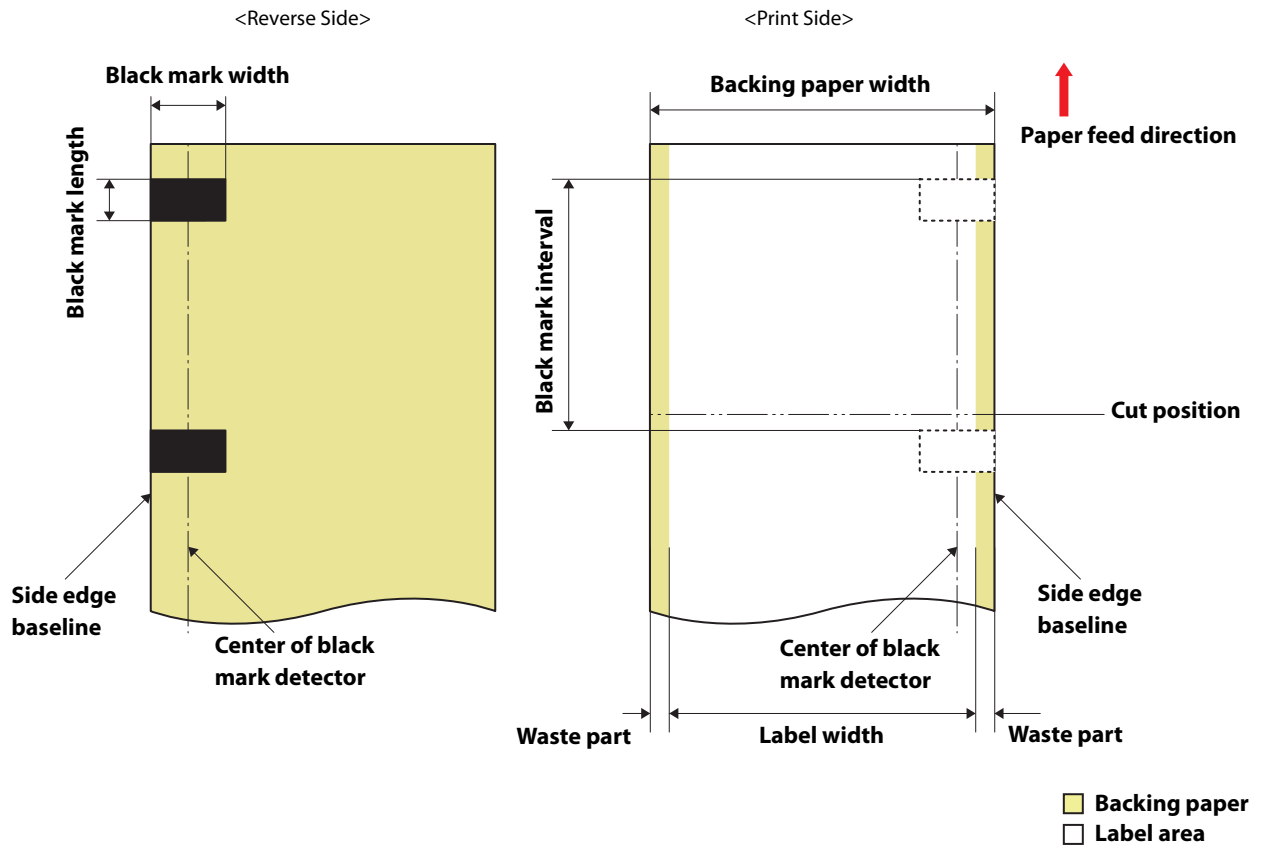

Form	Roll paper
Backing paper width	25.4 to 112 mm (1 to 4.41 inches)
Label width	With waste part: 25.4 to 112 mm (1 to 4.41 inches) Without waste part: 21.4 to 108 mm (0.84 to 4.25 inches)
Label length	-
Gap between Labels	-
Waste part on the left and right	With waste part: - Without waste part: 2 ± 0.5 mm (0.08 ± 0.02 inches)
Label corner R	-
Paper thickness	Plain Paper/Matte Paper/Synthetic/Texture Paper/Glossy Paper/Glossy Film/ High Glossy Paper 0.12 to 0.24 mm (0.005 to 0.009 inches)
Roll paper core inner diameter	76.2 ± 0.5 mm (3 ± 0.02 inches)
Roll paper outer diameter	203.2 mm (8 inches) or less
Winding direction	Print side must be facing outside (facing inside is unusable)
Black mark position	Each black mark should extends at least 18.4 mm (0.72 inches) from side edge baseline.
Black mark width	18.4 mm (0.72 inches) or more

Black mark length	4 to 25.4 mm (0.16 to 1 inch), 4 mm (0.16 inches) or more of blank space on label
Black mark interval*1	8 to 609.6 mm (0.31 to 24.24 inches)

\*1: It is not allowed to have another black mark in the intervening space between the black marks (black mark interval).



- Labels and backing paper with holes or cutouts cannot be used.
- Set the cut position to a position at least 1.7 mm (0.07 inches) away from the black mark of the next label.
- Set the start position of the first label to a position at least 1.5 mm (0.06 inches) away from the leading edge of the backing paper.

### Roll paper Continuous label (without black marks)

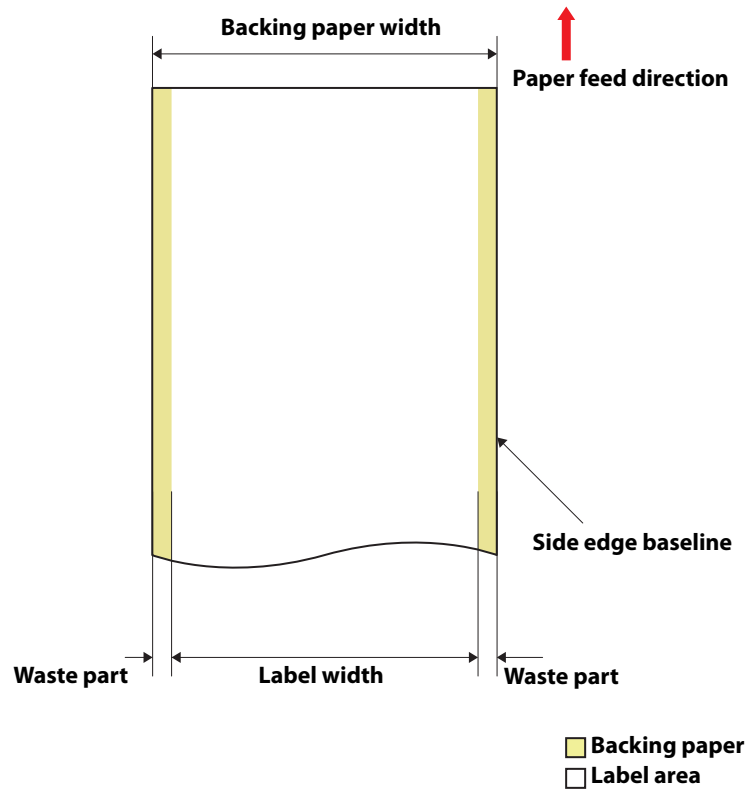

Form	Roll paper
Backing paper width	25.4 to 112 mm (1 to 4.41 inches)
Label width	With waste part: 25.4 to 112 mm (1 to 4.41 inches) Without waste part: 21.4 to 108 mm (0.84 to 4.25 inches)
Label length	-
Gap between Labels	-
Waste part on the left and right	With waste part: - Without waste part: $2 \pm 0.5$ mm ( $0.08 \pm 0.02$ inches)
Label corner R	-
Paper thickness	Plain Paper/Matte Paper/Synthetic/Texture Paper/Glossy Paper/Glossy Film/ High Glossy Paper 0.12 to 0.24 mm (0.005 to 0.009 inches)
Roll paper core inner diameter	$76.2 \pm 0.5$ mm ( $3 \pm 0.02$ inches)
Roll paper outer diameter	203.2 mm (8 inches) or less
Winding direction	Print side must be facing outside (facing inside is unusable)



- Labels and backing paper with holes or cutouts cannot be used.

### Fanfold Die-cut Label (Black Mark)

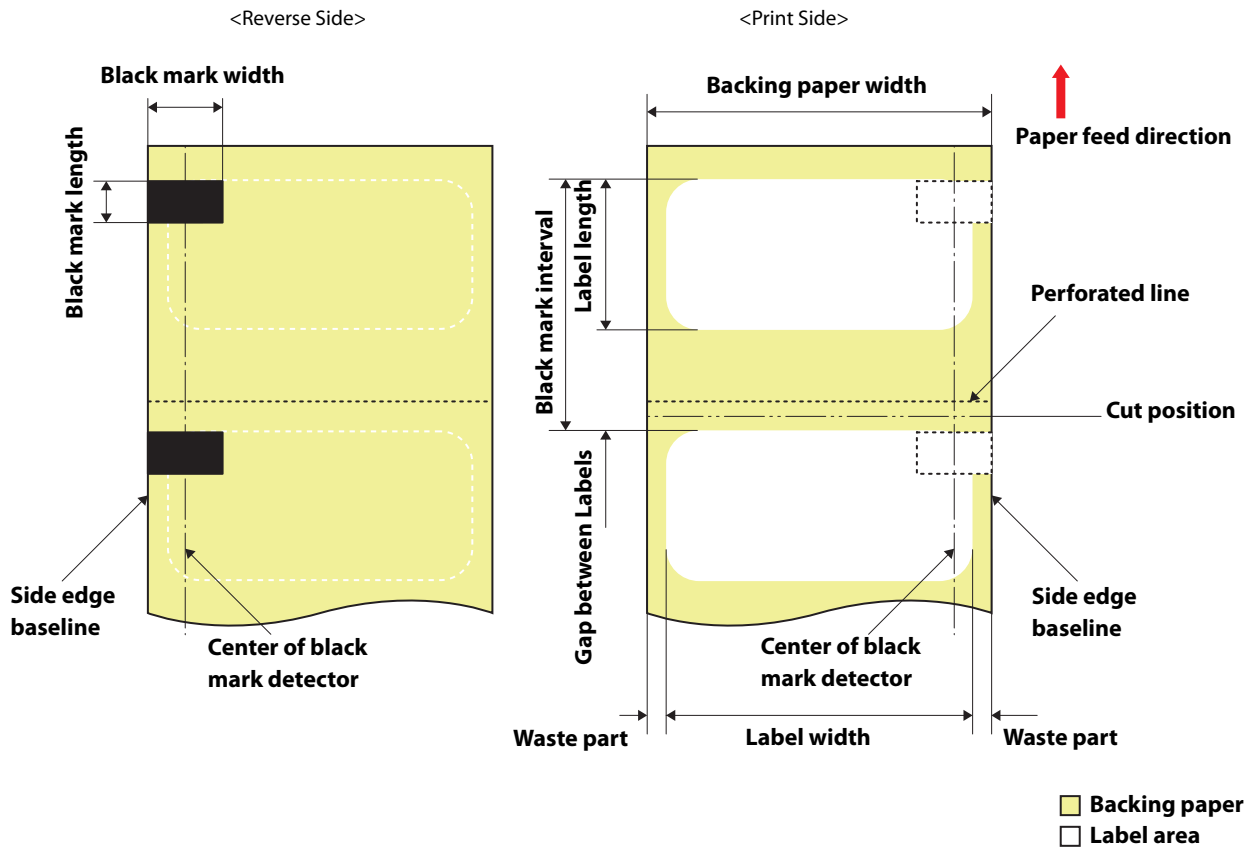

Form	Fanfold
Backing paper width	25.4 to 112 mm (1 to 4.41 inches)
Label width	21.4 to 108 mm (0.84 to 4.25 inches)
Label length	When auto cut is not used: 8 to 301.8 mm (0.31 to 11.88 inches) (up to 11.9 inches) When auto cut is used: 15 to 301.8 mm (0.59 to 11.88 inches) (up to 11.9 inches)
Gap between Labels	When auto cut is not used: 2 to 6 mm (0.08 to 0.24 inches) When auto cut is used: 3 to 6 mm (0.12 to 0.24 inches)
Waste part on the left and right	2 ± 0.5 mm (0.08 ± 0.02 inches)
Label corner R	1.5 mm (0.06 inches) or less
Paper thickness	Plain Paper/Matte Paper/Synthetic/Texture Paper/Glossy Paper/Glossy Film/ High Glossy Paper 0.12 to 0.24 mm (0.005 to 0.009 inches)
The number of folds	750 or less
Perforated line interval	152.4 to 304.8 mm (6 to 12 inches)
Black mark position	Each black mark should extends at least 18.4 mm (0.72 inches) from side edge baseline.
Black mark width	18.4 mm (0.72 inches) or more

Black mark length	4 to 25.4 mm (0.16 to 1 inch), 4 mm (0.16 inches) or more of blank space on label
Black mark interval*1	When auto cut is not used: 10 to 307.8 mm (0.39 to 12.12 inches) When auto cut is used: 18 to 307.8 mm (0.71 to 12.12 inches)
Perforation interval	Three (hole portion) to one (no hole portion)
Perforation form	Usable if a hole is located at side edges

\*1: It is not allowed to have another black mark in the intervening space between the black marks (black mark interval).



- Labels and backing paper with holes or cutouts cannot be used.
- Auto cutting on the perforated lines will generate scraps of paper that may cause problems. Also, auto cutting ahead of the perforated line may cause problems when feeding paper. Therefore, perform auto cutting when paper is fed at least 0.8 mm (0.03 inches) away from the perforated line.
- Set the black mark position to a position at least 2.5 mm (0.1 inches) away from the perforated line.
- Set the cut position to a position at least 1.7 mm (0.07 inches) away from the black mark of the next label.
- Set the start position of the first label to a position at least 1.5 mm (0.06 inches) away from the leading edge of the backing paper.

## CW-C6000 Series (4-inch peeler model)

### Roll Die-cut Label (Black Mark)

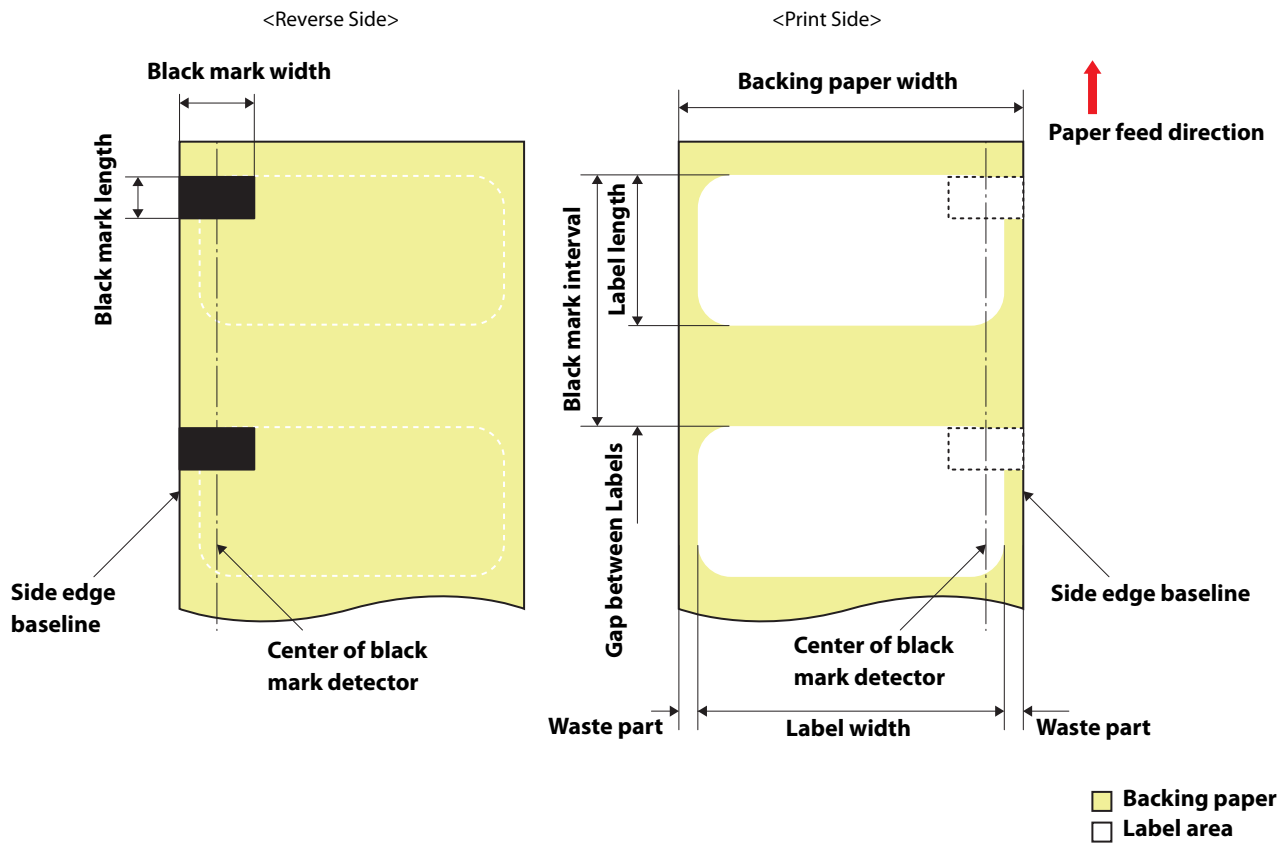

Form	Roll paper
Backing paper width	50.8 to 112 mm (2 to 4.41 inches)
Label width	46.8 to 108 mm (1.84 to 4.25 inches)
Label length	When peeler is not used: 8 to 609.6 mm (0.31 to 24 inches) (up to 24 inches) When peeler is used: 12.7 to 609.6 mm (0.5 to 24 inches) (up to 24 inches)
Gap between Labels	2 to 6 mm (0.08 to 0.24 inches)
Waste part on the left and right	2 ± 0.5 mm (0.08 ± 0.02 inches)
Label corner R	1.5 mm (0.06 inches) or less
Paper thickness	Plain Paper/Matte Paper/Synthetic/Texture Paper/Glossy Paper/Glossy Film/ High Glossy Paper 0.12 to 0.24 mm (0.005 to 0.009 inches)
Roll paper core inner diameter	76.2 ± 0.5 mm (3 ± 0.02 inches)
Roll paper outer diameter	203.2 mm (8 inches) or less
Winding direction	Print side must be facing outside (facing inside is unusable)

Black mark position	Each black mark should extends at least 18.4 mm (0.72 inches) from side edge baseline.
Black mark width	18.4 mm (0.72 inches) or more
Black mark length	4 to 25.4 mm (0.16 to 1 inch), 4 mm (0.16 inches) or more of blank space on label
Black mark interval	When peeler is not used: 10 to 615.6 mm (0.39 to 24.24 inches) When peeler is used: 14.7 to 615.6 mm (0.58 to 24.24 inches)



- Labels and backing paper with holes or cutouts cannot be used.
- Set the start position of the first label to a position at least 1.5 mm (0.06 inches) away from the leading edge of the backing paper.
- You cannot use paper with perforation. If you use the paper, the perforation may be torn and/or a paper jam may occur.
- If a blade of die had cut deep into paper, the die-cut labels become hard to be removed from the backing paper, and the peeler may fail to peel off those die-cut labels.

## Roll Die-cut Label (without Black Mark)

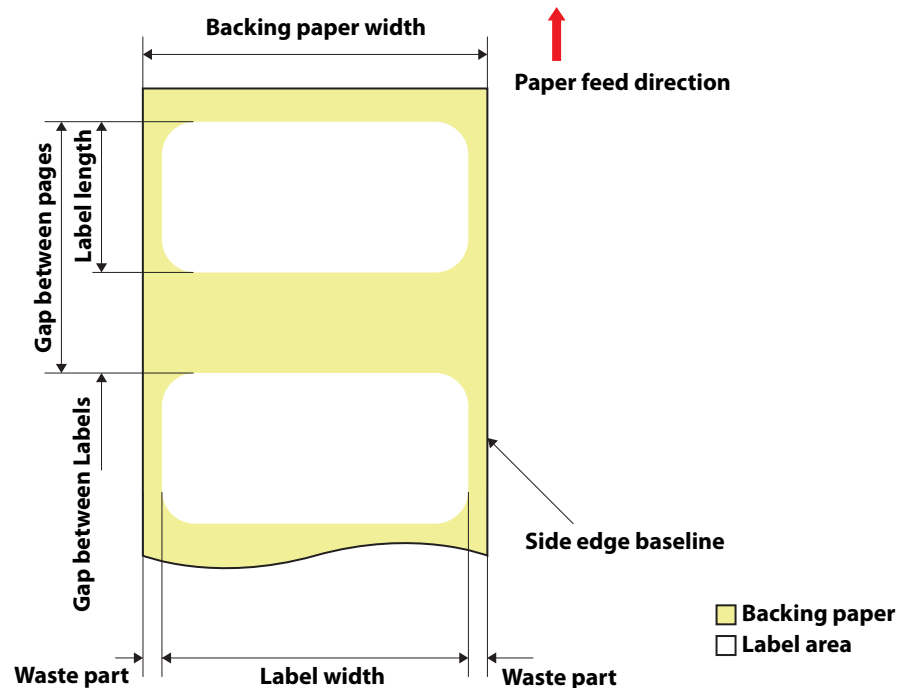

Form	Roll paper
Backing paper width	50.8 to 112 mm (2 to 4.41 inches)
Label width	46.8 to 108 mm (1.84 to 4.25 inches)
Label length	When peeler is not used: 8 to 609.6 mm (0.31 to 24 inches) (up to 24 inches) When peeler is used: 12.7 to 609.6 mm (0.5 to 24 inches) (up to 24 inches)
Gap between Labels	2 to 6 mm (0.08 to 0.24 inches)
Waste part on the left and right	$2 \pm 0.5$ mm ( $0.08 \pm 0.02$ inches)
Label corner R	1.5 mm (0.06 inches) or less
Paper thickness	Plain Paper/Matte Paper/Synthetic/Texture Paper/Glossy Paper/Glossy Film/ High Glossy Paper 0.12 to 0.24 mm (0.005 to 0.009 inches)
Roll paper core inner diameter	$76.2 \pm 0.5$ mm ( $3 \pm 0.02$ inches)
Roll paper outer diameter	203.2 mm (8 inches) or less
Winding direction	Print side must be facing outside (facing inside is unusable)



- Labels and backing paper with holes or cutouts cannot be used.
- Set the start position of the first label to a position at least 1.5 mm (0.06 inches) away from the leading edge of the backing paper.
- You cannot use paper with perforation. If you use the paper, the perforation may be torn and/or a paper jam may occur.
- If a blade of die had cut deep into paper, the die-cut labels become hard to be removed from the backing paper, and the peeler may fail to peel off those die-cut labels.

## CW-C6500 Series (8-inch auto cutter model)

### Roll Die-cut Label (Black Mark)

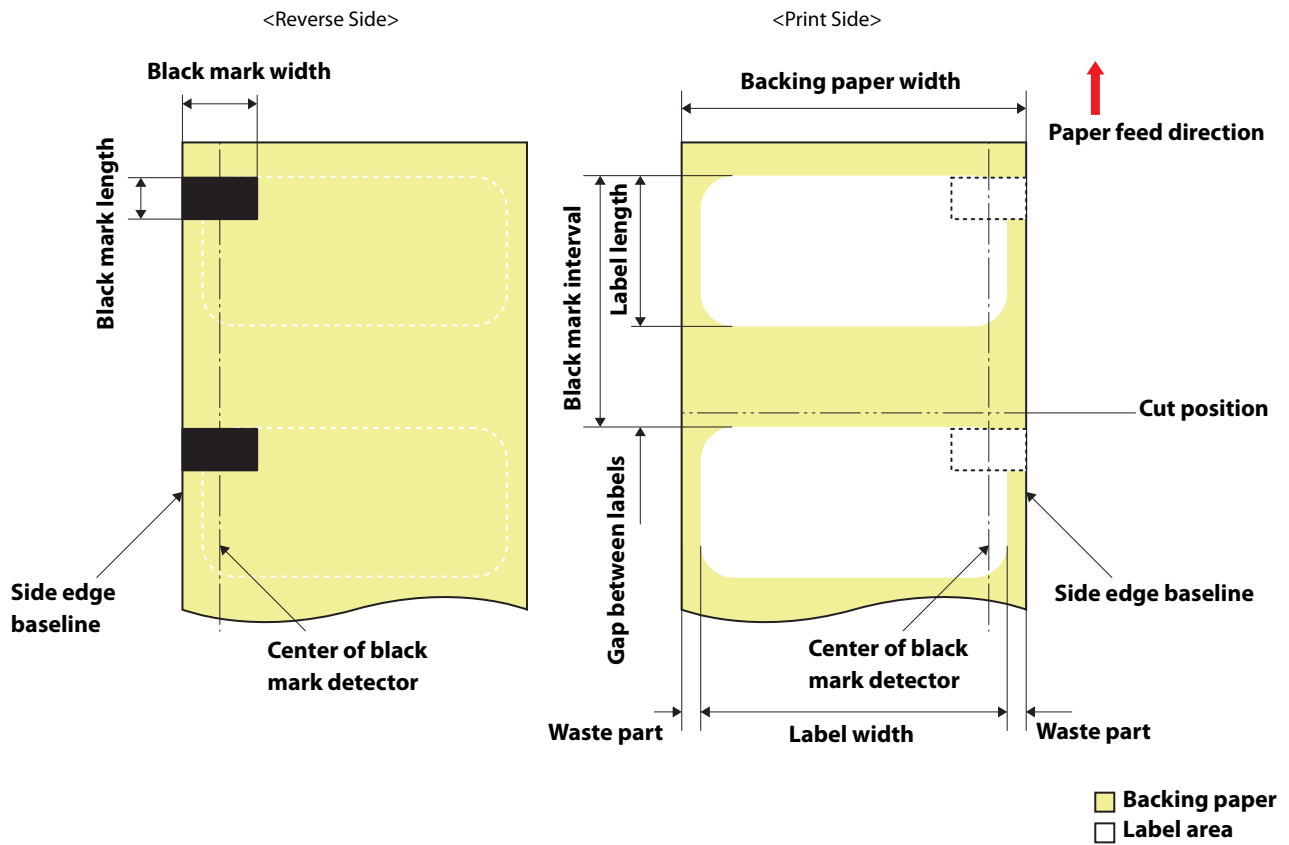

Form	Roll paper
Backing paper width	25.4 to 215.9 mm (1 to 8.5 inches)
Label width	21.4 to 211.9 mm (0.84 to 8.34 inches)
Label length	When auto cut is not used: 8 to 609.6 mm (0.31 to 24 inches) (up to 24 inches) When auto cut is used: 15 to 609.6 mm (0.59 to 24 inches) (up to 24 inches)
Gap between Labels	When auto cut is not used: 2 to 6 mm (0.08 to 0.24 inches) When auto cut is used: 2.5 to 6 mm (0.1 to 0.24 inches)
Waste part on the left and right	2 ± 0.5 mm (0.08 ± 0.02 inches)
Label corner R	1.5 mm (0.06 inches) or less
Paper thickness	Plain Paper/Matte Paper/Synthetic/Texture Paper/Glossy Paper/Glossy Film/ High Glossy Paper 0.12 to 0.24 mm (0.005 to 0.009 inches)
Roll paper core inner diameter	76.2 ± 0.5 mm (3 ± 0.02 inches)
Roll paper outer diameter	152.4 mm (6 inches) or less
Winding direction	Print side must be facing outside (facing inside is unusable)

Black mark position	Each black mark should extend at least 18.4 mm (0.72 inches) from side edge baseline.
Black mark width	18.4 mm (0.72 inches) or more
Black mark length	4 to 25.4 mm (0.16 to 1 inch), 4 mm (0.16 inches) or more of blank space on label
Black mark interval* 1	When auto cut is not used: 10 to 615.6 mm (0.39 to 24.24 inches) When auto cut is used: 17.5 to 615.6 mm (0.69 to 24.24 inches)

\*1: It is not allowed to have another black mark in the intervening space between the black marks (black mark interval).



- Labels and backing paper with holes or cutouts cannot be used.
- Set the cut position to a position at least 1.7 mm (0.07 inches) away from the black mark of the next label.
- Set the start position of the first label to a position at least 1.5 mm (0.06 inches) away from the leading edge of the backing paper.

## Roll Die-cut Label (without Black Mark)

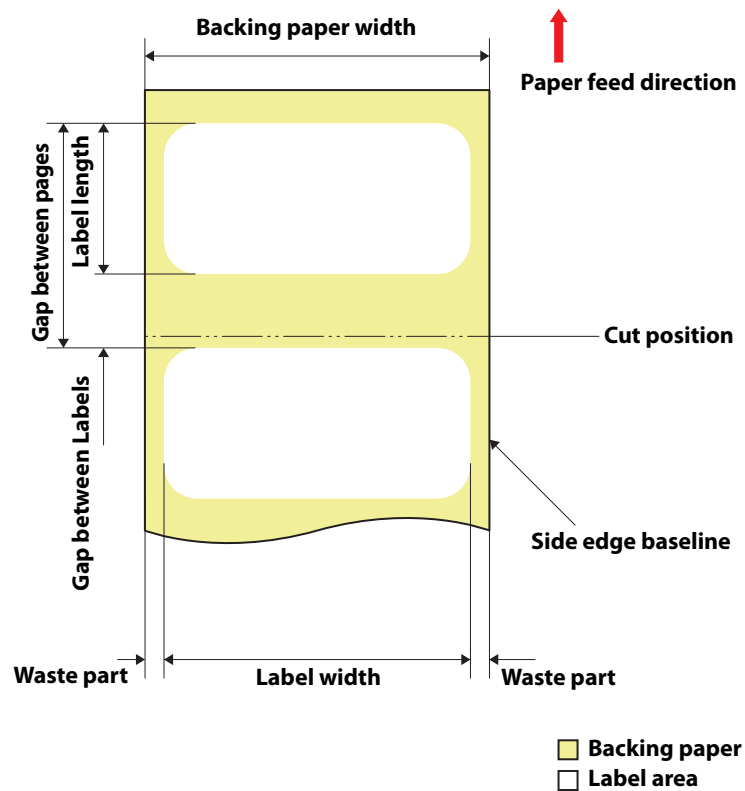

Form	Roll paper
Backing paper width	25.4 to 215.9 mm (1 to 8.5 inches)
Label width	21.4 to 211.9 mm (0.84 to 8.34 inches)
Label length	When auto cut is not used: 8 to 609.6 mm (0.31 to 24 inches) (up to 24 inches) When auto cut is used: 15 to 609.6 mm (0.59 to 24 inches) (up to 24 inches)
Gap between Labels	2 to 6 mm (0.08 to 0.24 inches)
Waste part on the left and right	$2 \pm 0.5$ mm ( $0.08 \pm 0.02$ inches)
Label corner R	1.5 mm (0.06 inches) or less
Paper thickness	Plain Paper/Matte Paper/Synthetic/Texture Paper/Glossy Paper/Glossy Film/ High Glossy Paper 0.12 to 0.24 mm (0.005 to 0.009 inches)
Roll paper core inner diameter	$76.2 \pm 0.5$ mm ( $3 \pm 0.02$ inches)
Roll paper outer diameter	152.4 mm (6 inches) or less
Winding direction	Print side must be facing outside (facing inside is unusable)



- Labels and backing paper with holes or cutouts cannot be used.
- Set the cut position to a position at least 0.7 mm (0.03 inches) away from the leading edge of the next label.
- Set the start position of the first label to a position at least 1.5 mm (0.06 inches) away from the leading edge of the backing paper.

## Roll paper Die-cut Label with perforation (Black Mark)

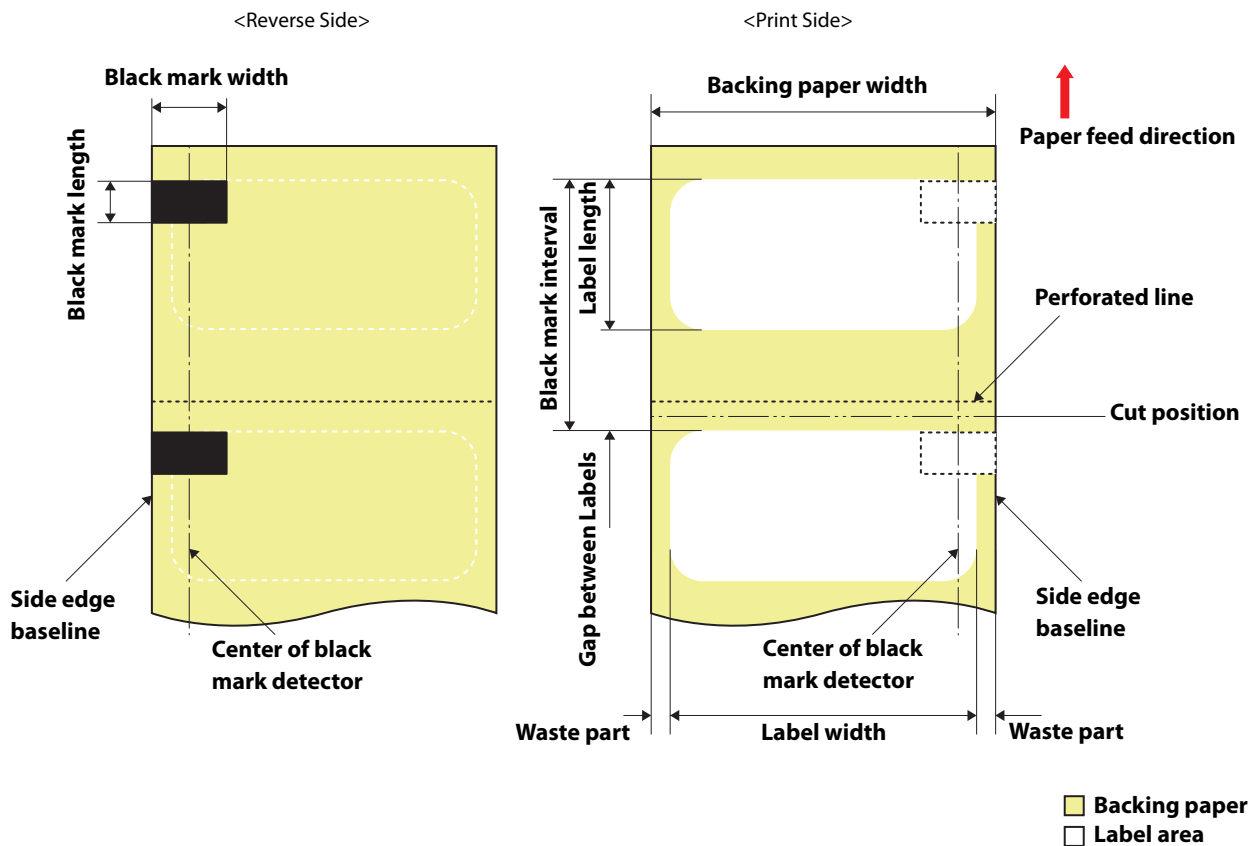

Form	Roll paper
Backing paper width	25.4 to 215.9 mm (1 to 8.5 inches)
Label width	21.4 to 211.9 mm (0.84 to 8.34 inches)
Label length	When auto cut is not used: 8 to 609.6 mm (0.31 to 24 inches) (up to 24 inches) When auto cut is used: 15 to 609.6 mm (0.59 to 24 inches) (up to 24 inches)
Gap between Labels	When auto cut is not used: 2 to 6 mm (0.08 to 0.24 inches) When auto cut is used: 3 to 6 mm (0.12 to 0.24 inches)
Waste part on the left and right	$2 \pm 0.5$ mm ( $0.08 \pm 0.02$ inches)
Label corner R	1.5 mm (0.06 inches) or less
Paper thickness	Plain Paper/Matte Paper/Synthetic/Texture Paper/Glossy Paper/Glossy Film/ High Glossy Paper 0.12 to 0.24 mm (0.005 to 0.009 inches)
Roll paper core inner diameter	$76.2 \pm 0.5$ mm ( $3 \pm 0.02$ inches)
Roll paper outer diameter	152.4 mm (6 inches) or less
Winding direction	Print side must be facing outside (facing inside is unusable)
Black mark position	Each black mark should extends at least 18.4 mm (0.72 inches) from side edge baseline.

Black mark width	18.4 mm (0.72 inches) or more
Black mark length	4 to 25.4 mm (0.16 to 1 inch), 4 mm (0.16 inches) or more of blank space on label
Black mark interval*1	When auto cut is not used: 10 to 615.6 mm (0.39 to 24.24 inches) When auto cut is used: 18 to 615.6 mm (0.7 to 24.24 inches)
Perforation interval	Three (hole portion) to one (no hole portion)
Perforation form	Usable if a hole is located at side edges

\*1: It is not allowed to have another black mark in the intervening space between the black marks (black mark interval).



- Labels and backing paper with holes or cutouts cannot be used.
- Auto cutting on the perforated lines will generate scraps of paper that may cause problems. Also, auto cutting ahead of the perforated line may cause problems when feeding paper. Therefore, perform auto cutting when paper is fed at least 0.8 mm (0.03 inches) away from the perforated line.
- Set the black mark position to a position at least 2.5 mm (0.1 inches) away from the perforated line.
- Set the cut position to a position at least 1.7 mm (0.07 inches) away from the black mark of the next label.
- Set the start position of the first label to a position at least 1.5 mm (0.06 inches) away from the leading edge of the backing paper.

## Roll paper Die-cut Label with perforation (without black marks)

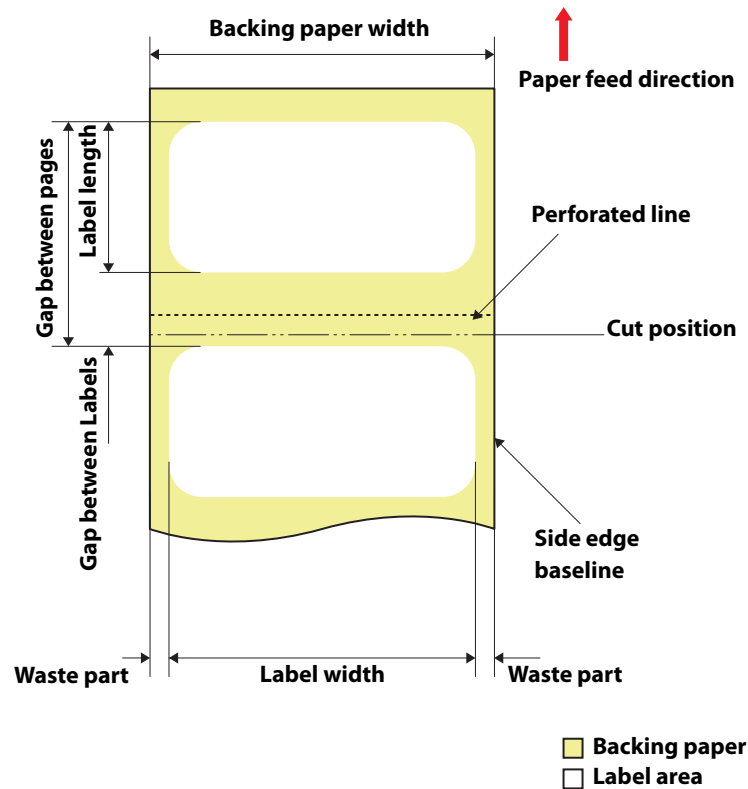

Form	Roll paper
Backing paper width	25.4 to 215.9 mm (1 to 8.5 inches)
Label width	21.4 to 211.9 mm (0.84 to 8.34 inches)
Label length	When auto cut is not used: 8 to 609.6 mm (0.31 to 24 inches) (up to 24 inches) When auto cut is used: 15 to 609.6 mm (0.59 to 24 inches) (up to 24 inches)
Gap between Labels	When auto cut is not used: 2 to 6 mm (0.08 to 0.24 inches) When auto cut is used: 3 to 6 mm (0.12 to 0.24 inches)
Waste part on the left and right	$2 \pm 0.5$ mm ( $0.08 \pm 0.02$ inches)
Label corner R	1.5 mm (0.06 inches) or less
Paper thickness	Plain Paper/Matte Paper/Synthetic/Texture Paper/Glossy Paper/Glossy Film/ High Glossy Paper 0.12 to 0.24 mm (0.005 to 0.009 inches)
Roll paper core inner diameter	$76.2 \pm 0.5$ mm ( $3 \pm 0.02$ inches)
Roll paper outer diameter	152.4 mm (6 inches) or less
Winding direction	Print side must be facing outside (facing inside is unusable)
Perforation interval	Three (hole portion) to one (no hole portion)
Perforation form	Usable if a hole is located at side edges



- Labels and backing paper with holes or cutouts cannot be used.
- Auto cutting on the perforated lines will generate scraps of paper that may cause problems. Also, auto cutting ahead of the perforated line may cause problems when feeding paper. Therefore, perform auto cutting when paper is fed at least 0.8 mm (0.03 inches) away from the perforated line.
- Set the leading edge of the next label to a position at least 1.5 mm (0.06 inches) away from the perforated line.
- Set the cut position to a position at least 0.7 mm (0.03 inches) away from the leading edge of the next label.

### Roll paper Continuous Label (Black Mark)

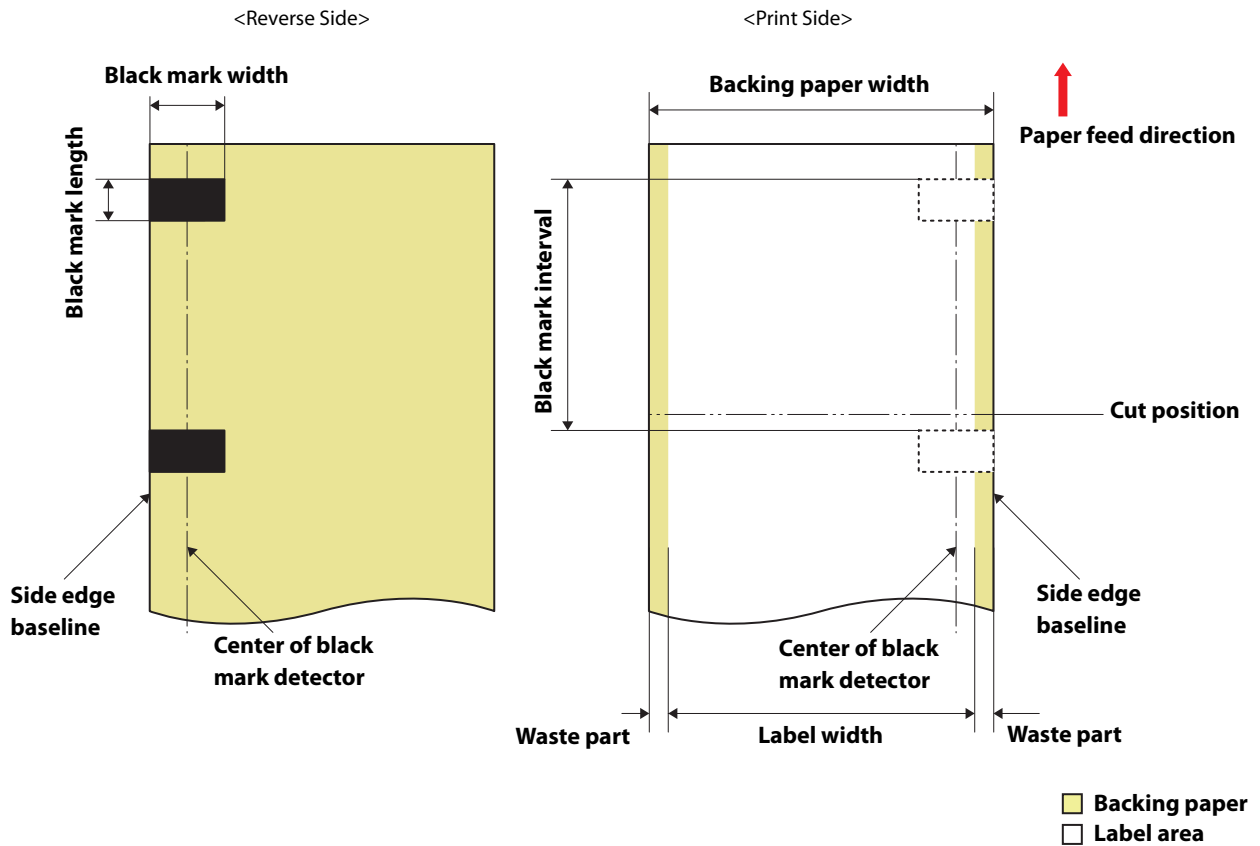

Form	Roll paper
Backing paper width	25.4 to 215.9 mm (1 to 8.5 inches)
Label width	With waste part: 25.4 to 215.9 mm (1 to 8.5 inches) Without waste part: 21.4 to 211.9 mm (0.84 to 8.34 inches)
Label length	-
Gap between Labels	-
Waste part on the left and right	With waste part: - Without waste part: $2 \pm 0.5$ mm ( $0.08 \pm 0.02$ inches)
Label corner R	-
Paper thickness	Plain Paper/Matte Paper/Synthetic/Texture Paper/Glossy Paper/Glossy Film/ High Glossy Paper 0.12 to 0.24 mm (0.005 to 0.009 inches)
Roll paper core inner diameter	$76.2 \pm 0.5$ mm ( $3 \pm 0.02$ inches)
Roll paper outer diameter	152.4 mm (6 inches) or less
Winding direction	Print side must be facing outside (facing inside is unusable)
Black mark position	Each black mark should extends at least 18.4 mm (0.72 inches) from side edge baseline.

Black mark width	18.4 mm (0.72 inches) or more
Black mark length	4 to 25.4 mm (0.16 to 1 inch), 4 mm (0.16 inches) or more of blank space on label
Black mark interval*1	8 to 609.6 mm (0.31 to 24.24 inches)

\*1: It is not allowed to have another black mark in the intervening space between the black marks (black mark interval).



- Labels and backing paper with holes or cutouts cannot be used.
- Set the cut position to a position at least 1.7 mm (0.07 inches) away from the black mark of the next label.
- Set the start position of the first label to a position at least 1.5 mm (0.06 inches) away from the leading edge of the backing paper.

### Roll paper Continuous label (without black marks)

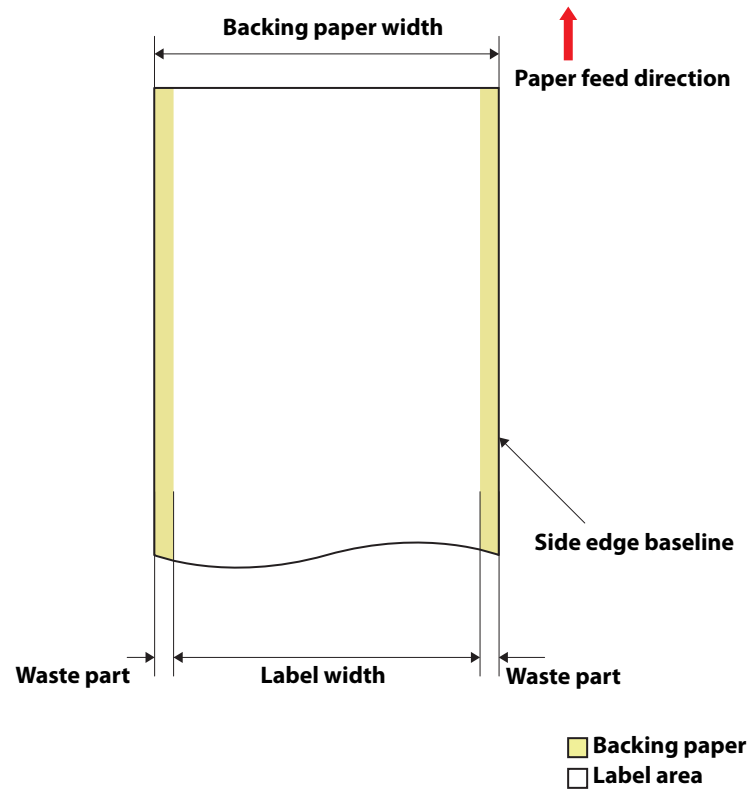

Form	Roll paper
Backing paper width	25.4 to 215.9 mm (1 to 8.5 inches)
Label width	With waste part: 25.4 to 215.9 mm (1 to 8.5 inches) Without waste part: 21.4 to 211.9 mm (0.84 to 8.34 inches)
Label length	-
Gap between Labels	-
Waste part on the left and right	With waste part: - Without waste part: $2 \pm 0.5$ mm ( $0.08 \pm 0.02$ inches)
Label corner R	-
Paper thickness	Plain Paper/Matte Paper/Synthetic/Texture Paper/Glossy Paper/Glossy Film/ High Glossy Paper 0.12 to 0.24 mm (0.005 to 0.009 inches)
Roll paper core inner diameter	$76.2 \pm 0.5$ mm ( $3 \pm 0.02$ inches)
Roll paper outer diameter	152.4 mm (6 inches) or less
Winding direction	Print side must be facing outside (facing inside is unusable)



- Labels and backing paper with holes or cutouts cannot be used.

### Fanfold Die-cut Label (Black Mark)

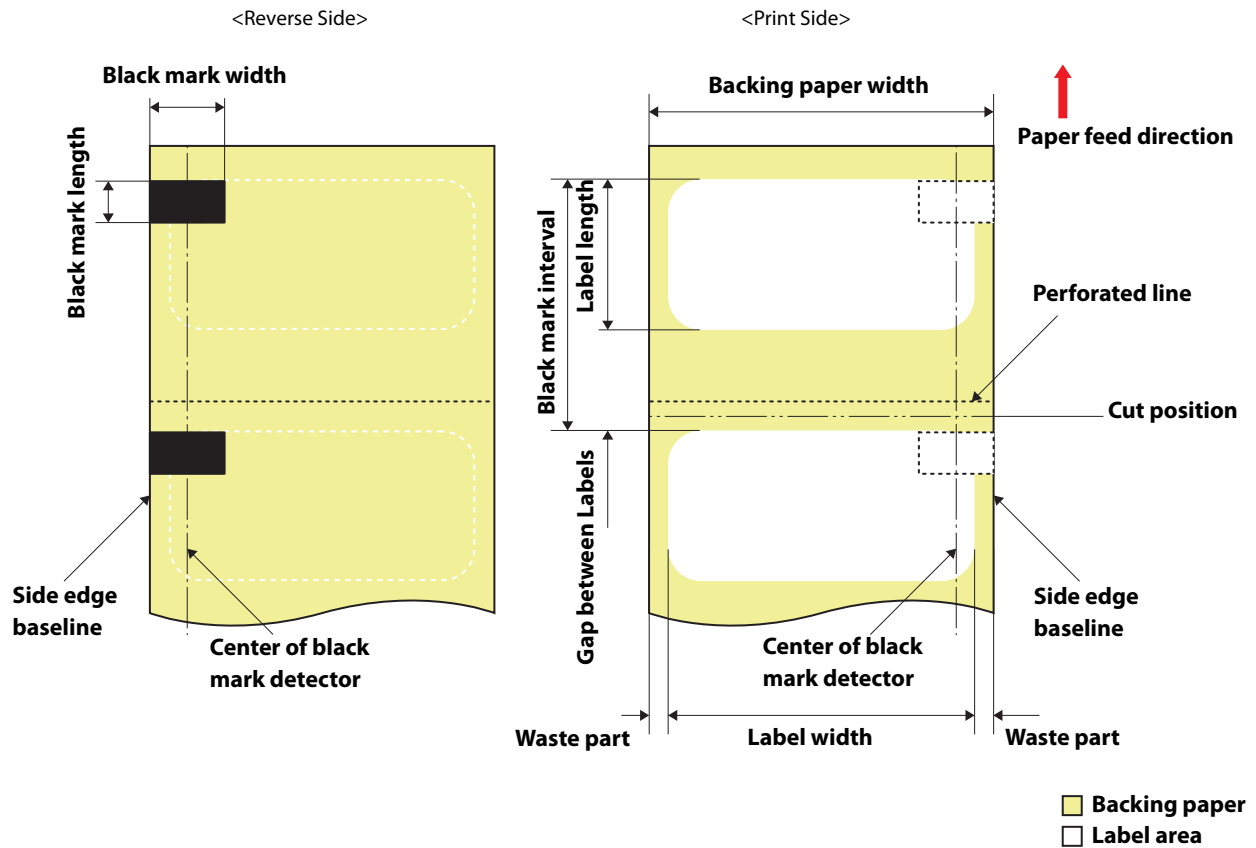

Form	Fanfold
Backing paper width	25.4 to 215.9 mm (1 to 8.5 inches)
Label width	21.4 to 211.9 mm (0.84 to 8.34 inches)
Label length	When auto cut is not used: 8 to 301.8 mm (0.31 to 11.88 inches) (up to 11.9 inches) When auto cut is used: 15 to 301.8 mm (0.59 to 11.88 inches) (up to 11.9 inches)
Gap between Labels	When auto cut is not used: 2 to 6 mm (0.08 to 0.24 inches) When auto cut is used: 3 to 6 mm (0.12 to 0.24 inches)
Waste part on the left and right	2 ± 0.5 mm (0.08 ± 0.02 inches)
Label corner R	1.5 mm (0.06 inches) or less
Paper thickness	Plain Paper/Matte Paper/Synthetic/Texture Paper/Glossy Paper/Glossy Film/ High Glossy Paper 0.12 to 0.24 mm (0.005 to 0.009 inches)
The number of folds	750 or less
Perforated line interval	152.4 to 304.8 mm (6 to 12 inches)
Black mark position	Each black mark should extends at least 18.4 mm (0.72 inches) from side edge baseline.
Black mark width	18.4 mm (0.72 inches) or more

Black mark length	4 to 25.4 mm (0.16 to 1 inch), 4 mm (0.16 inches) or more of blank space on label
Black mark interval*1	When auto cut is not used: 10 to 307.8 mm (0.39 to 12.12 inches) When auto cut is used: 18 to 307.8 mm (0.71 to 12.12 inches)
Perforation interval	Three (hole portion) to one (no hole portion)
Perforation form	Usable if a hole is located at side edges

\*1: It is not allowed to have another black mark in the intervening space between the black marks (black mark interval).



- Labels and backing paper with holes or cutouts cannot be used.
- Auto cutting on the perforated lines will generate scraps of paper that may cause problems. Also, auto cutting ahead of the perforated line may cause problems when feeding paper. Therefore, perform auto cutting when paper is fed at least 0.8 mm (0.03 inches) away from the perforated line.
- Set the black mark position to a position at least 2.5 mm (0.1 inches) away from the perforated line.
- Set the cut position to a position at least 1.7 mm (0.07 inches) away from the black mark of the next label.
- Set the start position of the first label to a position at least 1.5 mm (0.06 inches) away from the leading edge of the backing paper.

## CW-C6500 Series (8-inch peeler model)

### Roll Die-cut Label (Black Mark)

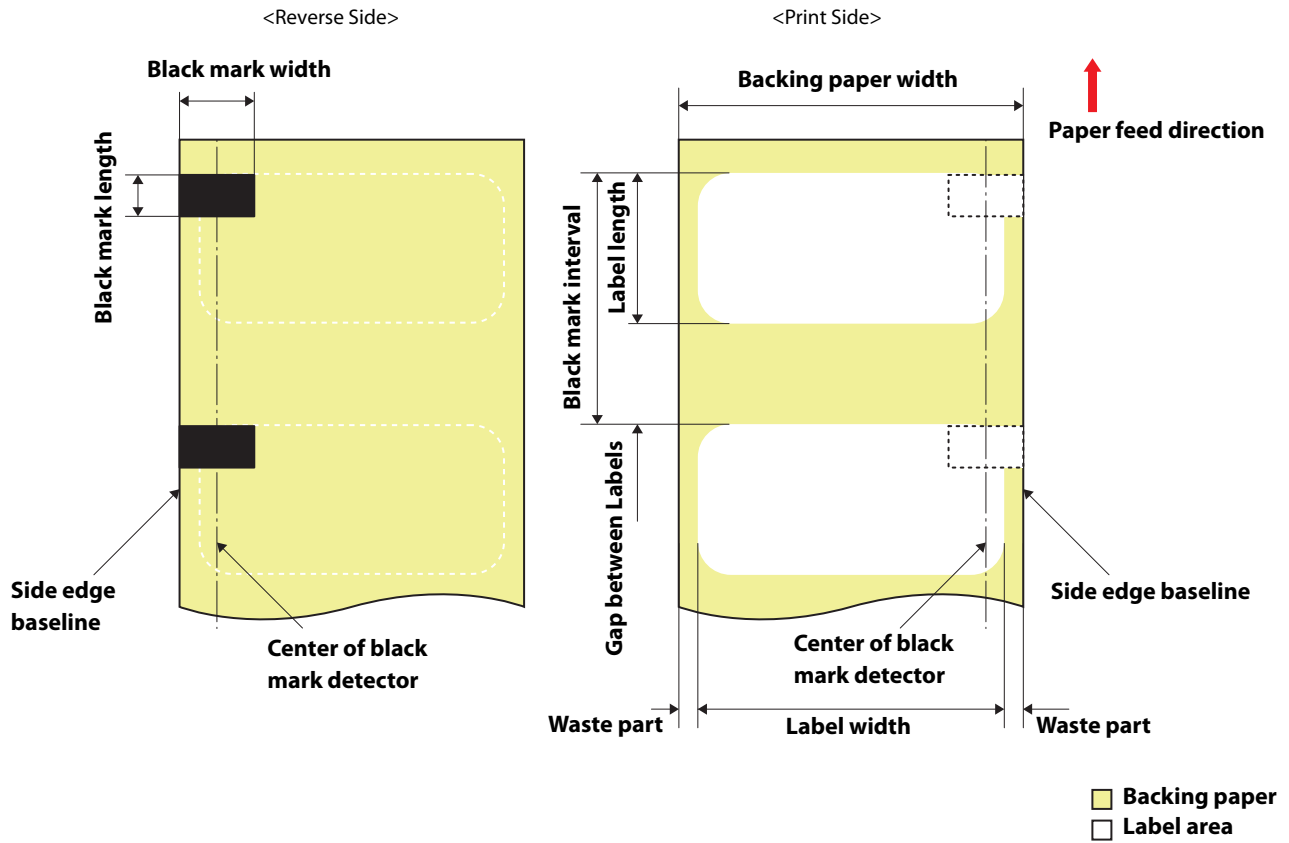

Form	Roll paper
Backing paper width	50.8 to 215.9 mm (2 to 8.5 inches)
Label width	46.8 to 211.9 mm (1.84 to 8.34 inches)
Label length	When peeler is not used: 8 to 609.6 mm (0.31 to 24 inches) (up to 24 inches) When peeler is used: 12.7 to 609.6 mm (0.5 to 24 inches) (up to 24 inches)
Gap between Labels	2 to 6 mm (0.08 to 0.24 inches)
Waste part on the left and right	2 ± 0.5 mm (0.08 ± 0.02 inches)
Label corner R	1.5 mm (0.06 inches) or less
Paper thickness	Plain Paper/Matte Paper/Synthetic/Texture Paper/Glossy Paper/Glossy Film/ High Glossy Paper 0.12 to 0.24 mm (0.005 to 0.009 inches)
Roll paper core inner diameter	76.2 ± 0.5 mm (3 ± 0.02 inches)
Roll paper outer diameter	152.4 mm (6 inches) or less
Winding direction	Print side must be facing outside (facing inside is unusable)

Black mark position	Each black mark should extends at least 18.4 mm (0.72 inches) from side edge baseline.
Black mark width	18.4 mm (0.72 inches) or more
Black mark length	4 to 25.4 mm (0.16 to 1 inch), 4 mm (0.16 inches) or more of blank space on label
Black mark interval	When peeler is not used: 10 to 615.6 mm (0.39 to 24.24 inches) When peeler is used: 14.7 to 615.6 mm (0.58 to 24.24 inches)



- Labels and backing paper with holes or cutouts cannot be used.
- Set the start position of the first label to a position at least 1.5 mm (0.06 inches) away from the leading edge of the backing paper.
- You cannot use paper with perforation. If you use the paper, the perforation may be torn and/or a paper jam may occur.
- If a blade of die had cut deep into paper, the die-cut labels become hard to be removed from the backing paper, and the peeler may fail to peel off those die-cut labels.

## Roll Die-cut Label (without Black Mark)

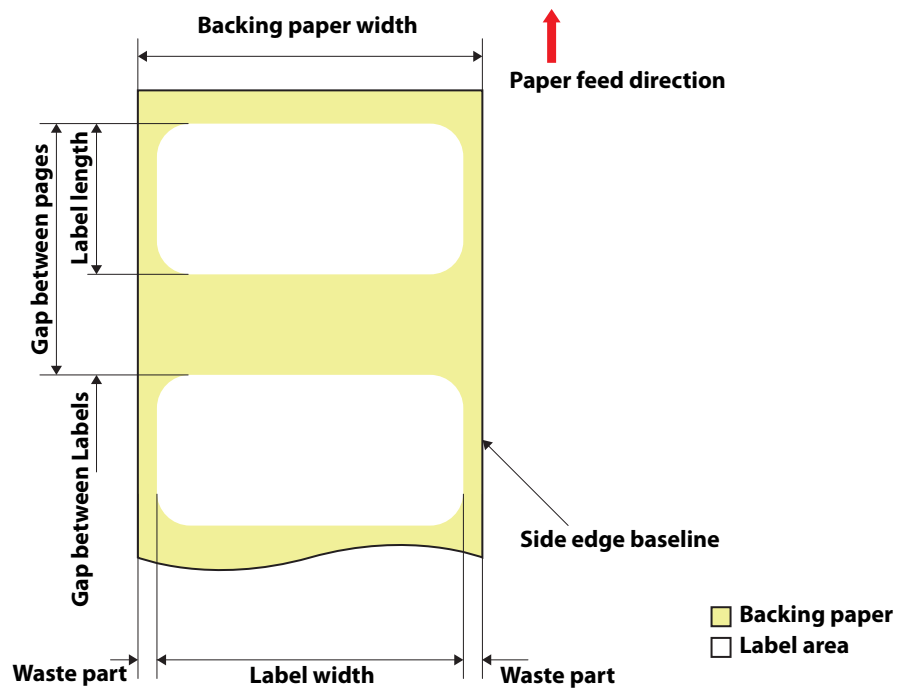

Form	Roll paper
Backing paper width	50.8 to 215.9 mm (2 to 8.5 inches)
Label width	46.8 to 211.9 mm (1.84 to 8.34 inches)
Label length	When peeler is not used: 8 to 609.6 mm (0.31 to 24 inches) (up to 24 inches) When peeler is used: 12.7 to 609.6 mm (0.5 to 24 inches) (up to 24 inches)
Gap between Labels	2 to 6 mm (0.08 to 0.24 inches)
Waste part on the left and right	$2 \pm 0.5$ mm ( $0.08 \pm 0.02$ inches)
Label corner R	1.5 mm (0.06 inches) or less
Paper thickness	Plain Paper/Matte Paper/Synthetic/Texture Paper/Glossy Paper/Glossy Film/ High Glossy Paper 0.12 to 0.24 mm (0.005 to 0.009 inches)
Roll paper core inner diameter	$76.2 \pm 0.5$ mm ( $3 \pm 0.02$ inches)
Roll paper outer diameter	152.4 mm (6 inches) or less
Winding direction	Print side must be facing outside (facing inside is unusable)



- Labels and backing paper with holes or cutouts cannot be used.
- Set the start position of the first label to a position at least 1.5 mm (0.06 inches) away from the leading edge of the backing paper.
- You cannot use paper with perforation. If you use the paper, the perforation may be torn and/or a paper jam may occur.
- If a blade of die had cut deep into paper, the die-cut labels become hard to be removed from the backing paper, and the peeler may fail to peel off those die-cut labels.



### Continuous Label (Black Mark)

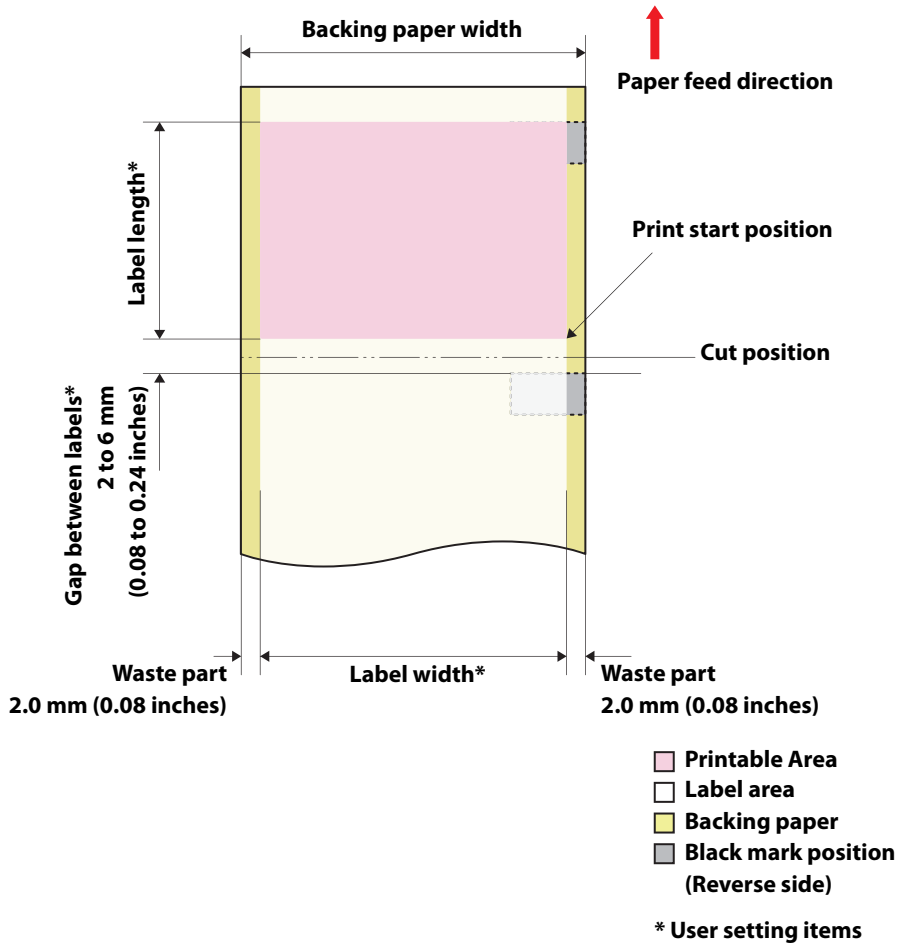

### Continuous Label

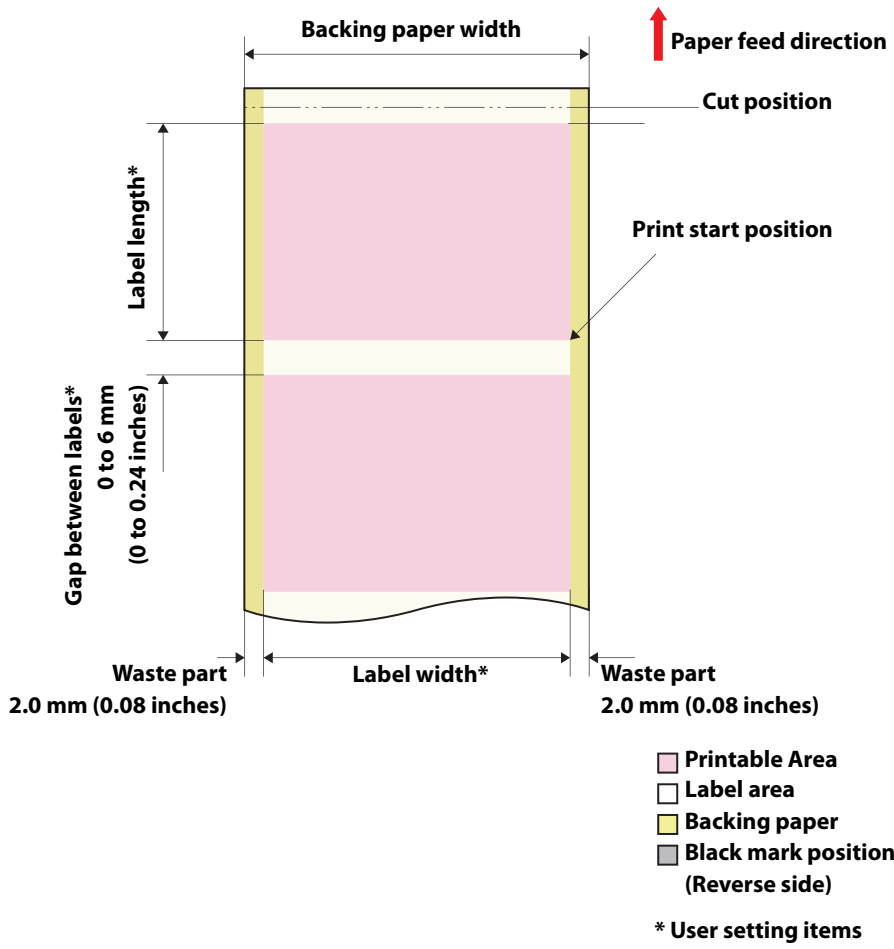

## Paper detection method

Sensor	Label sensor (Transmissive photo interrupter)
	Black mark sensor (Reflective photo interrupter)
Judging method	The label sensor and black mark sensor detect the position of the paper.



- When using die-cut label without black marks, the light transmission rates must be: 40% or higher for the backing paper, and 23% or lower for the labels.
- When using paper with black marks, the black mark reflectance rate must be 10% or lower, and the white reflectance rate is 70% or higher.

## Electrical Specifications

Item		CW-C6000 Series	CW-C6500 Series
Power supply		Power supply through a power connector	
Rated voltage		100 to 240 V	
Rated current		0.9 A	
Power consumption*	Operating*	100V: Average of approx. 39.4 W 230V: Average of approx. 38.6 W	100V: Average of approx. 39.5 W 230V: Average of approx. 38.7 W
	Standby	100V: Average of approx. 7.51 W 230V: Average of approx. 5.82 W	100V: Average of approx. 7.51 W 230V: Average of approx. 5.82 W
	Power off	100V: Average of approx. 0.08 W 230V: Average of approx. 0.24 W	100V: Average of approx. 0.08 W 230V: Average of approx. 0.24 W

\*Based on Epson evaluation conditions

## Reliability

Product life	Printer	<p>When any one of the following is reached</p> <ul style="list-style-type: none"> <li>• 5 years</li> <li>• 200 km or 1,500,000 pages</li> <li>• 6,000,000 cycles of total cr</li> <li>• 1,500,000 times of valve operation inside the ink path</li> </ul>
	Auto cutter mechanism	<p>Die-cut label (Plain Paper): 1,500,000 cuts</p> <p>Die-cut label (Matte Paper): 1,500,000 cuts</p> <p>Die-cut label (Synthetic): 500,000 cuts</p> <p>Die-cut label (Texture Paper): 500,000 cuts</p> <p>Die-cut label (Glossy Paper): 1,500,000 cuts</p> <p>Die-cut label (Glossy Film): 1,500,000 cuts</p> <p>Die-cut label (High Glossy Paper): 1,500,000 cuts</p> <p>Continuous label (Plain Paper): 200,000 cuts</p> <p>Continuous label (Matte Paper): 200,000 cuts</p> <p>Continuous label (Synthetic): 100,000 cuts</p> <p>Continuous label (Texture Paper): 100,000 cuts</p> <p>Continuous label (Glossy Paper): 300,000 cuts</p> <p>Continuous label (Glossy Film): 100,000 cuts</p> <p>Continuous label (High Glossy Paper): 200,000 cuts</p>



- Depending of paper used, the reliability values may differ.
- The cutter reliability may differ if paper is changed to wider paper because it causes differences partially in degree of wear of the cutter blade.

## Environmental Specifications

Item		Specifications		
Temperature/ humidity	Printing	5 to 35°C (41 to 95°F), 20 to 80% RH without condensation (the blue-colored range in the graph)		
	Barcode printing	15 to 35°C (59 to 95°F), 20 to 80% RH without condensation		
	Storage	When packed (ink not charged)	-20 to 60°C (-4 to 140°F), 5 to 85% RH without condensation (When -20°C (-4°F) or 60°C (140°F), within 120 hours)	
		When ink charged	Gloss Black Ink	-15 to 40°C (5 to 104°F), 20 to 85% RH without condensation (When -15°C (5°F), within 120 hours) (When 0 to 25°C (32 to 77°F), within 6 months) (When 40°C (104°F), within 1 month)
		Matte Black Ink	-10 to 40°C (14 to 104°F), 20 to 85% RH without condensation (When -10°C (14°F), within 120 hours) (When 0 to 25°C (32 to 77°F), within 6 months) (When 40°C (104°F), within 1 month) Can be stored at -20°C (-4°F) by discharging ink in advance.	
Elevation		0 to 3000 m		
Noise		Auto cutter model: Approx. 55 dB Peeler model: Approx. 60 dB Based on Epson evaluation conditions.		

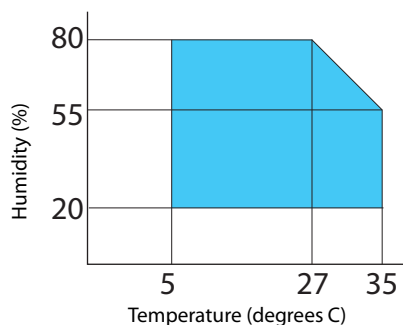

## Overall Dimensions

### CW-C6000 Series

#### ■ Printer Dimensions

##### Auto cutter model

- Width: 340 mm (13.39 inches)
- Depth: 565 mm (22.24 inches)
- Height: 326 mm (12.83 inches)

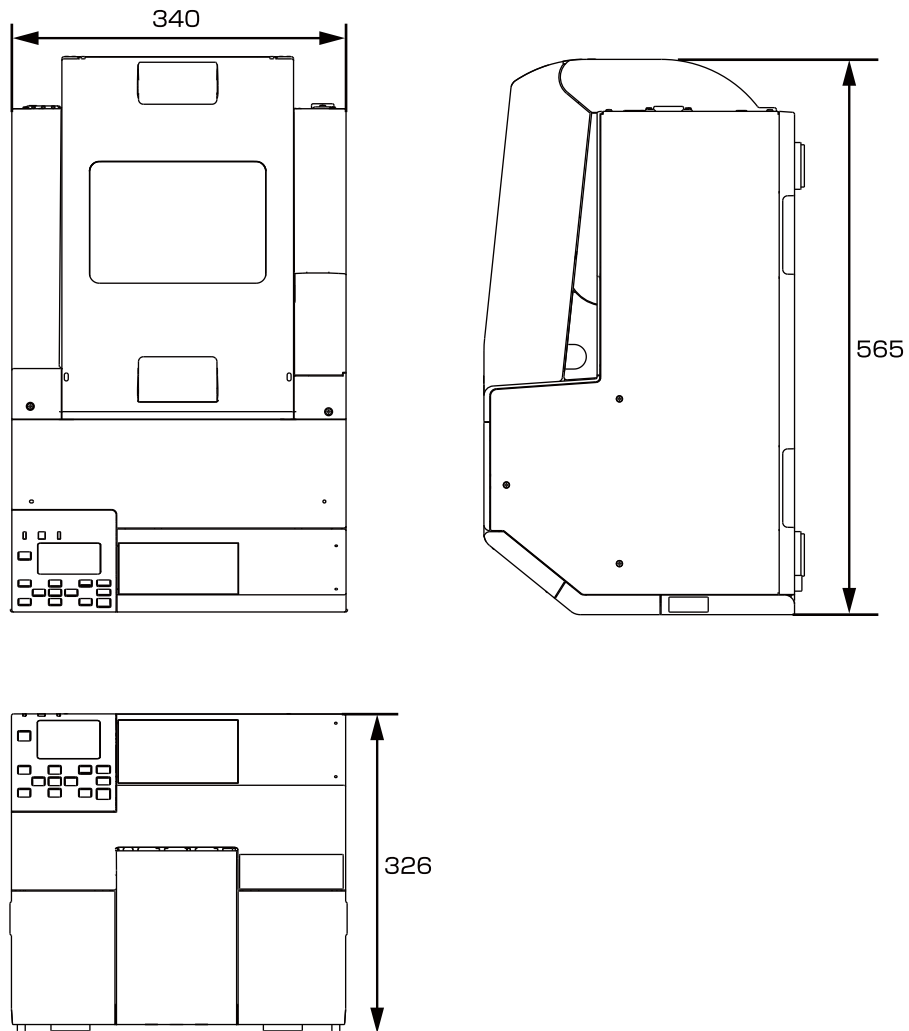

[Unit: mm]

**Peeler model**

- Width: 340 mm (13.39 inches)
- Depth: 565 mm (22.24 inches)
- Height: 326 mm (12.83 inches)

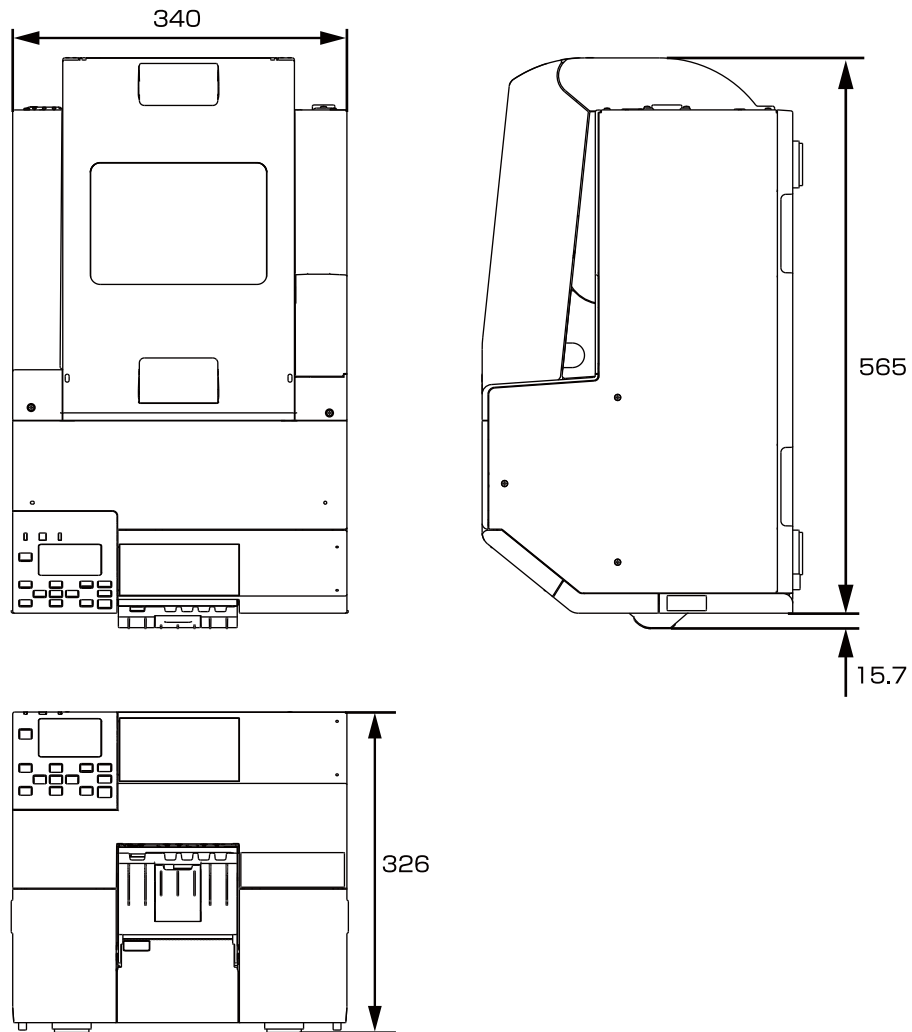

[Unit: mm]

■ When the cover is opened 1

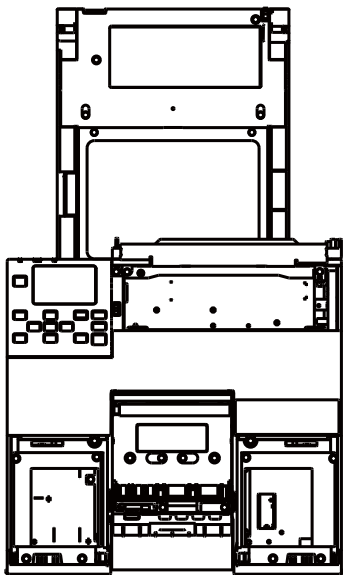
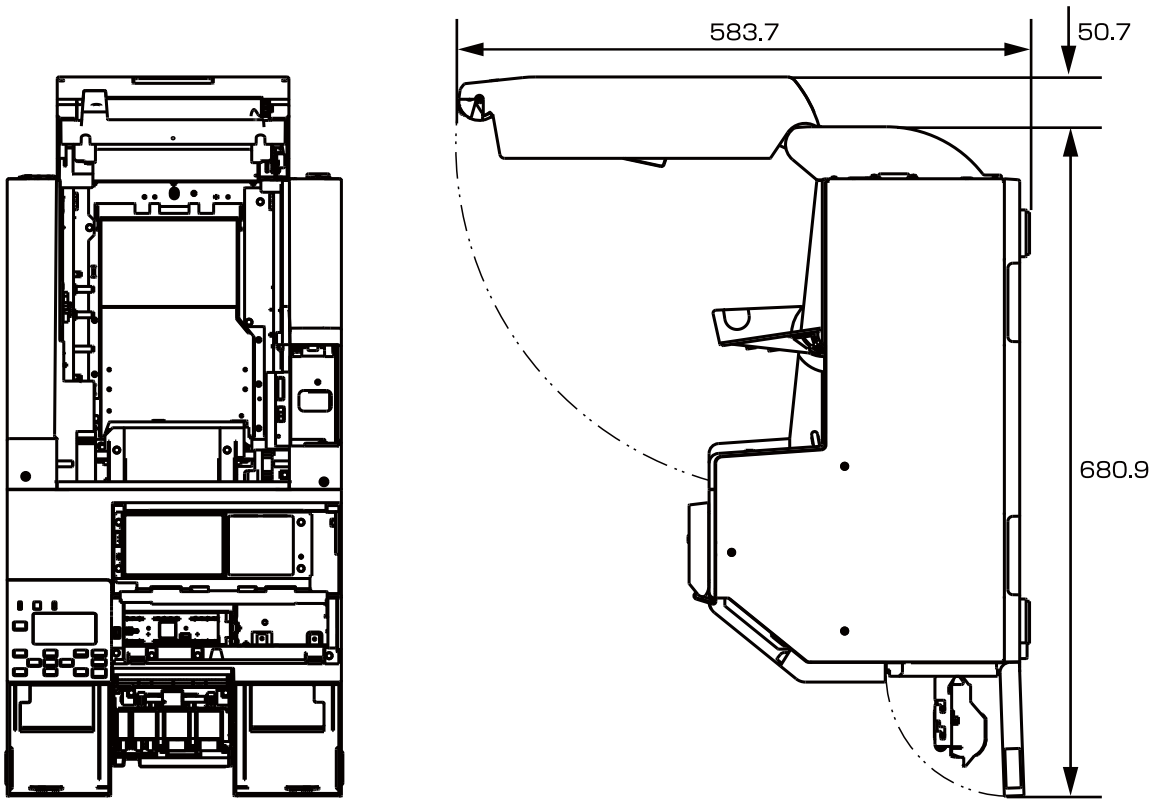

[Unit: mm]

## ■ When the cover is opened 2

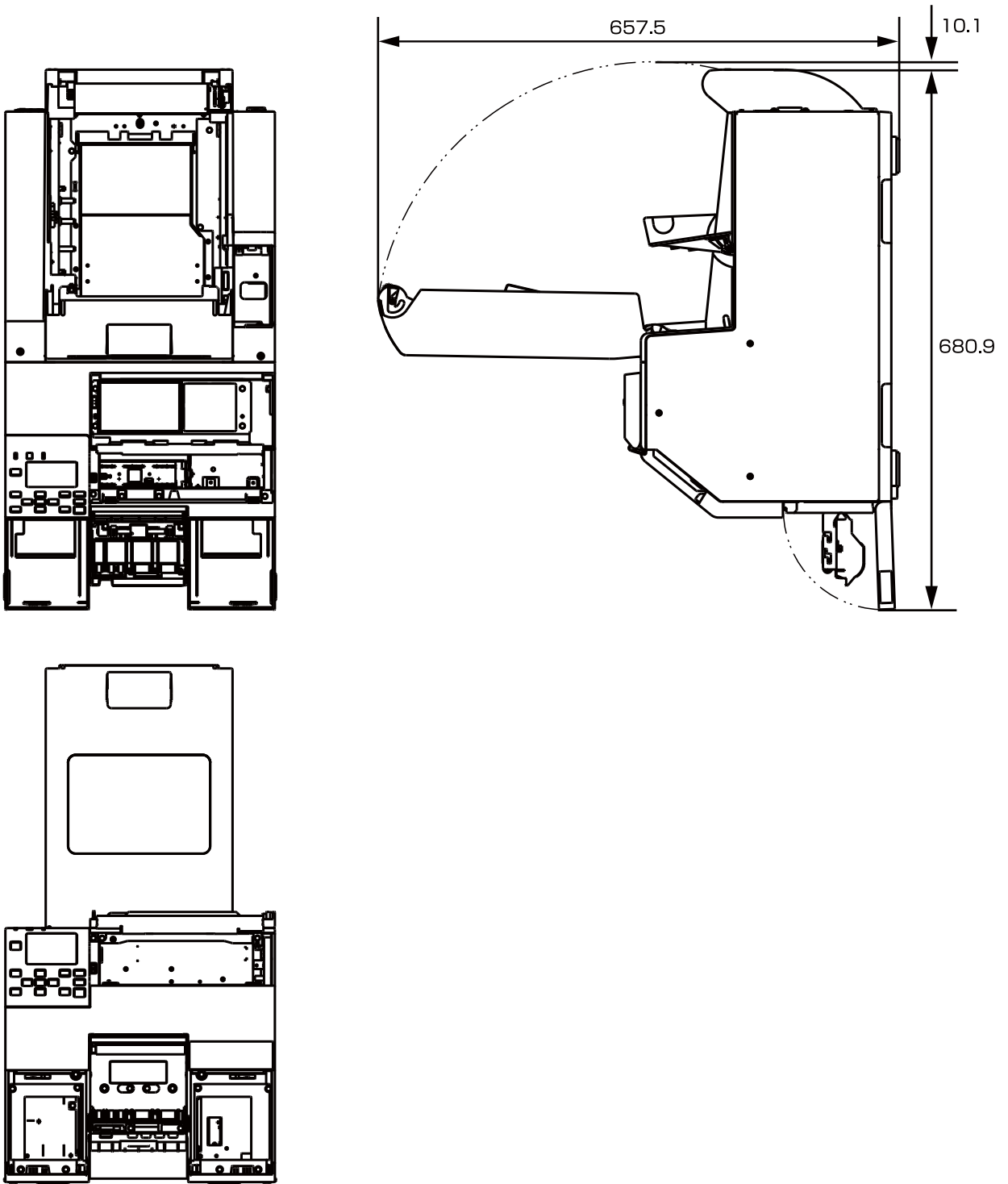

[Unit: mm]

---

## CW-C6500 Series

### ■ Printer Dimensions

#### Auto cutter model

- Width: 444 mm (17.48 inches)
- Depth: 515 mm (20.28 inches)
- Height: 326 mm (12.83 inches)

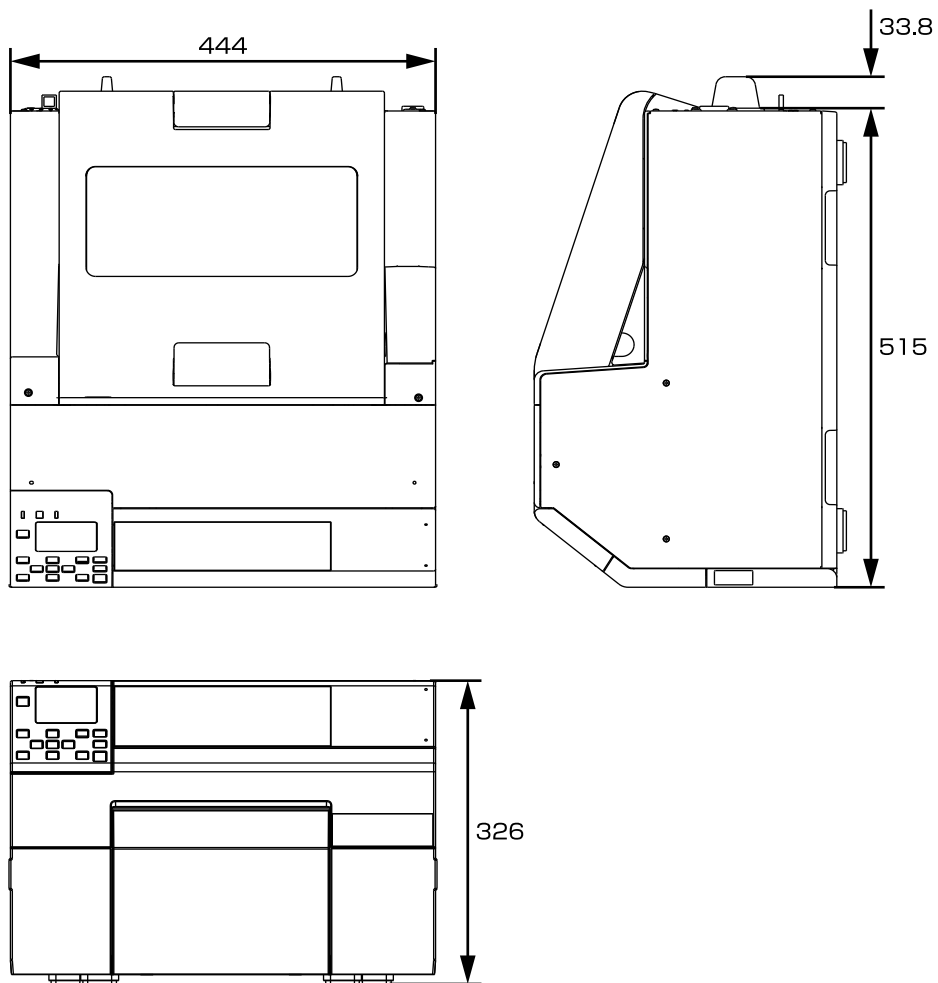

[Unit: mm]

### Peeler model

- Width: 444 mm (17.48 inches)
- Depth: 515 mm (20.28 inches)
- Height: 326 mm (12.83 inches)

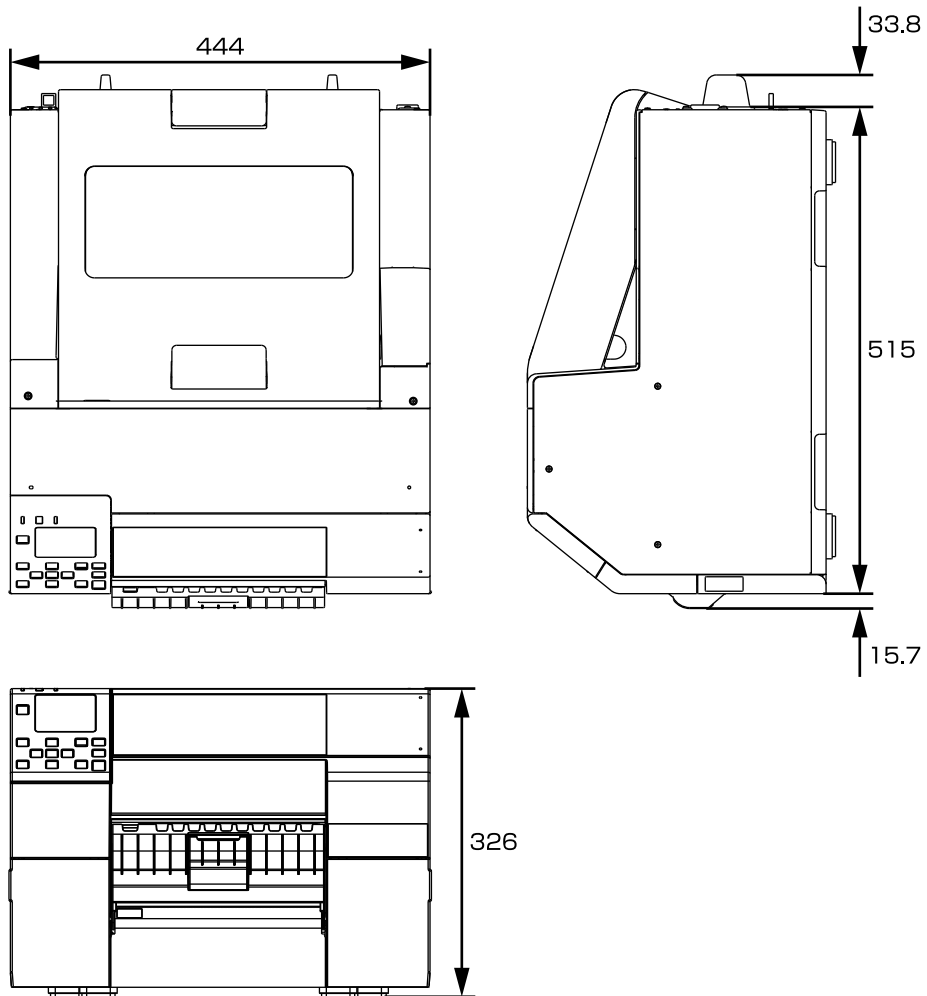

[Unit: mm]

■ When the cover is opened 1

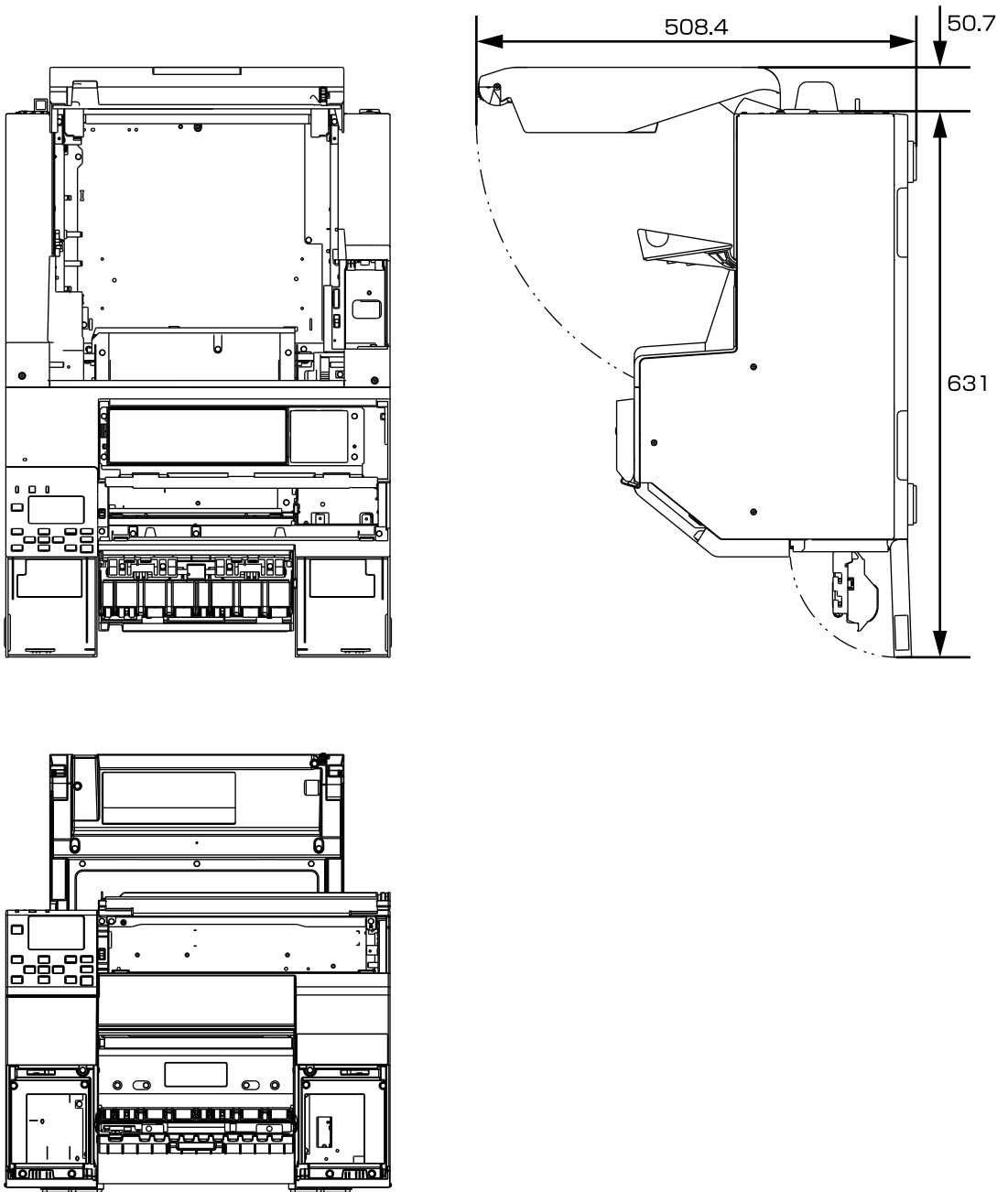

[Unit: mm]

■ When the cover is opened 2

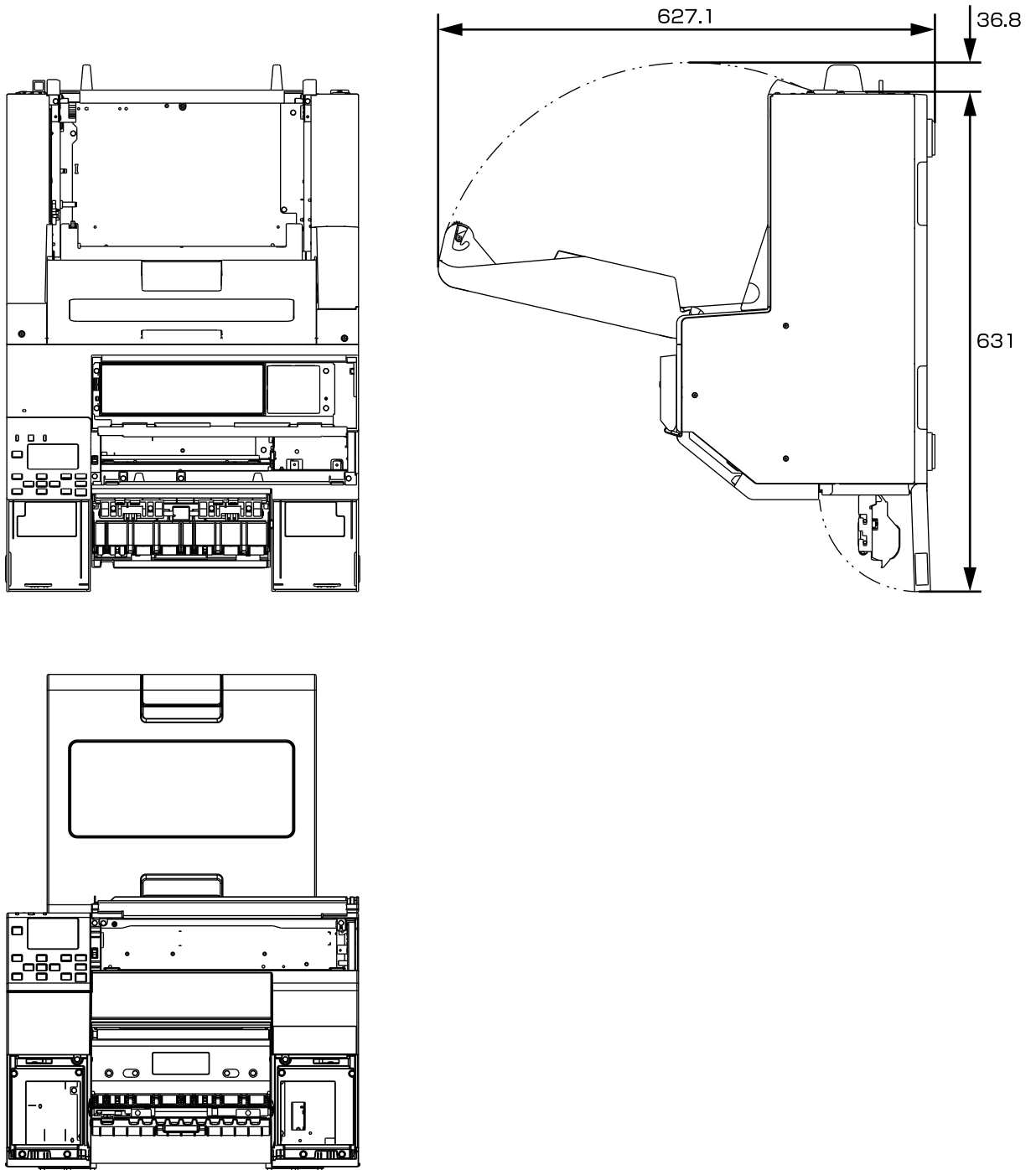

[Unit: mm]

## Consumables Specifications

### Ink Cartridges

Model number	CW-C6000Au CW-C6000Pu CW-C6500Au CW-C6500Pu	SJIC35P-BK/SJIC35P-MK*/SJIC35P-C/SJIC35P-M/SJIC35P-Y
	CW-C6000Ae CW-C6000Pe CW-C6500Ae CW-C6500Pe	SJIC36P-BK/SJIC36P-MK*/SJIC36P-C/SJIC36P-M/SJIC36P-Y
	CW-C6010A CW-C6010P CW-C6510A CW-C6510P	SJIC36P-BK/SJIC36P-MK*/SJIC36P-C/SJIC36P-M/SJIC36P-Y
	CW-C6020A CW-C6020P CW-C6520A CW-C6520P	SJIC37P-BK/SJIC37P-MK*/SJIC37P-C/SJIC37P-M/SJIC37P-Y
	CW-C6030A CW-C6030P CW-C6530A CW-C6530P	SJIC38P-BK/SJIC38P-MK*/SJIC38P-C/SJIC38P-M/SJIC38P-Y
	CW-C6040A CW-C6040P CW-C6540A CW-C6540P	SJIC39P-BK/SJIC39P-MK*/SJIC39P-C/SJIC39P-M/SJIC39P-Y
	CW-C6050A CW-C6050P CW-C6550A CW-C6550P	SJIC40P-BK/SJIC40P-MK*/SJIC40P-C/SJIC40P-M/SJIC40P-Y
	Type	4 individual color cartridges
Ink colors	Black (gloss black (BK), matte black (MK)), cyan (C), magenta (M), yellow (Y)	
Ink type	Pigmented ink	
Expiration date	6 months after installation in the printer, 3 years from the production date including the period of use	
Storage temperature	Transporting (without unpacking)	-20 to 60°C (-4 to 140°F) (within 5 days when 60°C (140°F))
	Storage (without unpacking)	-20 to 40°C (-4 to 104°F) (within 1 month when 40°C (104°F))
	Installed	-20 to 40°C (-4 to 104°F) (within 1 month when 40°C (104°F))

\* The matte black ink can be used if the firmware version of the printer is other than TS05JC, TS06JC, TS26JC, TS19K2, TS25K3, or TS21K5.

## Maintenance Box

Model number		SJMB6000/6500
Type		Maintenance box with integrated waste ink absorbing material
Storage temperature	Transporting (without unpacking)	-20 to 60°C (-4 to 140°F) (within 5 days when 60°C (140°F))
	Storage (without unpacking)	-20 to 40°C (-4 to 104°F) (within 1 month when 40°C (104°F))
	Installed	-20 to 40°C (-4 to 104°F) (within 1 month when 40°C (104°F))

## Option Specifications

### Roll Paper Holder

A spare roll paper holder is provided as an option. In the following cases, replacement of the roll paper can be performed quickly by loading paper beforehand in the spare roll paper holder.

- When you want to use paper of a different size or frequently change the label material
- When you want to reduce the down time as a result of roll paper replacement

Model number:

- Paper Holder C6000 (for CW-C6000 Series)
- Paper Holder C6500 (for CW-C6500 Series)

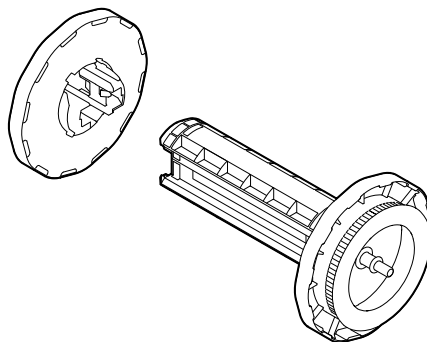

Item	Paper Holder C6000	Paper Holder C6500
Dimensions (H x W x D)	220 x 206 x 220 mm (8.66 x 8.11 x 8.66 inches)	175 x 310 x 175 mm (6.89 x 12.2 x 6.89 inches)
Weight	0.65 kg (1.43 lb)	0.65 kg (1.43 lb)

## Requirements for External Devices

If you use an external paper feeder and/or paper rewriter with the printer, read this section carefully to know required settings and requirements for using the external devices, and perform adequate verification before starting actual printing.

### Media Source Setting

When using an external paper feeder, change the media source setting to the setting for feeding paper from outside the printer.

#### Setting using the Printer Driver

Change the setting to [External feed] referring to ["Media Source and Media Detection Settings"](#) on page 85.

#### Setting using the Operation Panel

[Menu] - [Media Setting] - [Media Source] - [Rear Feed]

### Paper Feed Speed

The table below shows paper feed speeds of this product.

Print quality	Max paper feed speed
Max Speed	508 mm/s (20 inches/s)
Speed	508 mm/s (20 inches/s)
Normal	254 mm/s (10 inches/s)
Quality	127 mm/s (5 inches/s)
Max Quality	25.4 mm/s (1 inch/s)
Other	254 mm/s (10 inches/s)



- "Other" means a paper feed operation when the printer is not printing, such as when feeding paper with the Feed button.
- The max paper feed speed changes automatically according to the set print quality and the length to feed.

## Paper Tension

The allowable values of tension applied to paper between the printer and a paper feeder or rewinder are as follows.



If the paper tension varies too much, the paper may not be fed accurately.

### IMPORTANT

### Auto Cutter Model

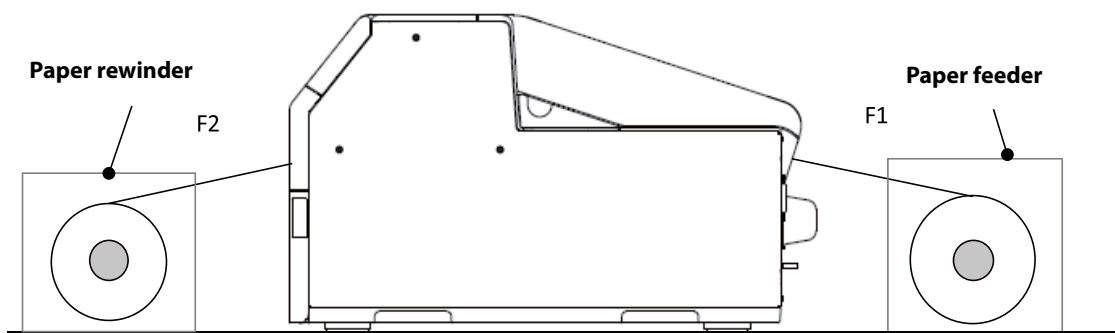

Paper tension at the feeder side (F1)	2N or less
Paper tension at the rewinder side (F2)	2N or less

### Peeler Model

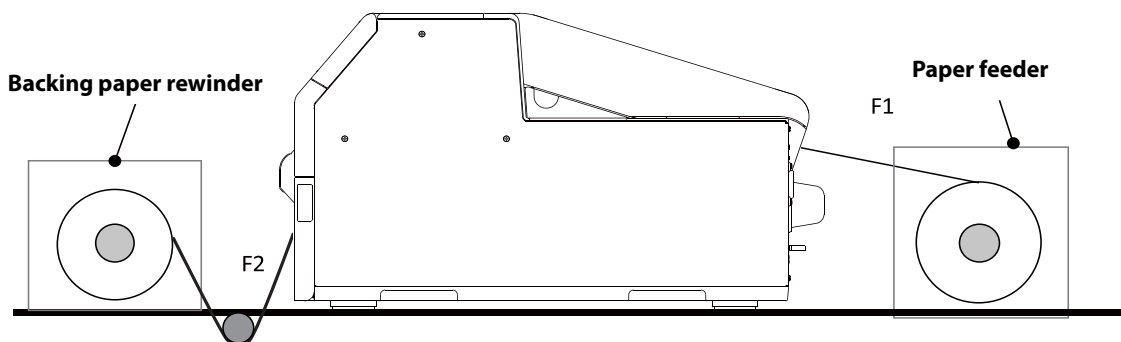

Paper tension at the feeder side (F1)	2N or less
Paper tension at the rewinder side (F2)	1N or less

## Paper Curl

When using a paper feeder, follow the guidelines below to prevent paper from curling.

When leaving the printer and the paper feeder unused for a long term, place the paper feeder so that paper is not curled in the direction opposite to the roll winding direction.

In addition, avoid letting the paper curl with a radius of 1.5 inches or less even if the paper is curled in the roll winding direction.

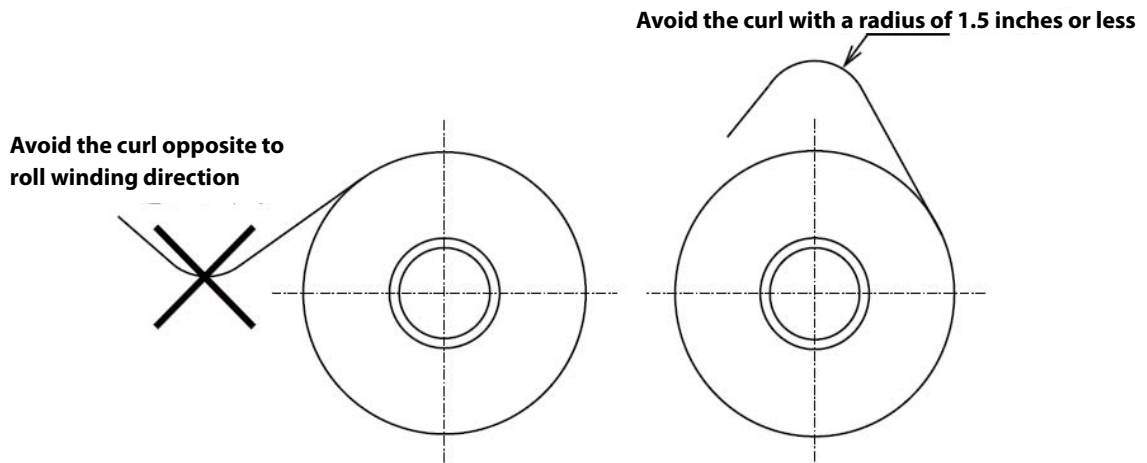

The outer diameter of the roll core should be at least 82 mm (3.23 inches).

## Paper Angle for Feeding and Ejecting

The allowable values of angle for feeding paper from a paper feeder ( $\theta_1$ ), for ejecting paper to a paper rewriter ( $\theta_2$ ) and for ejecting backing paper to a paper rewriter ( $\theta_3$ ) are as follows.



**CAUTION**

Take care not to let printed side of paper touch exteriors of the devices.

### Auto Cutter Model

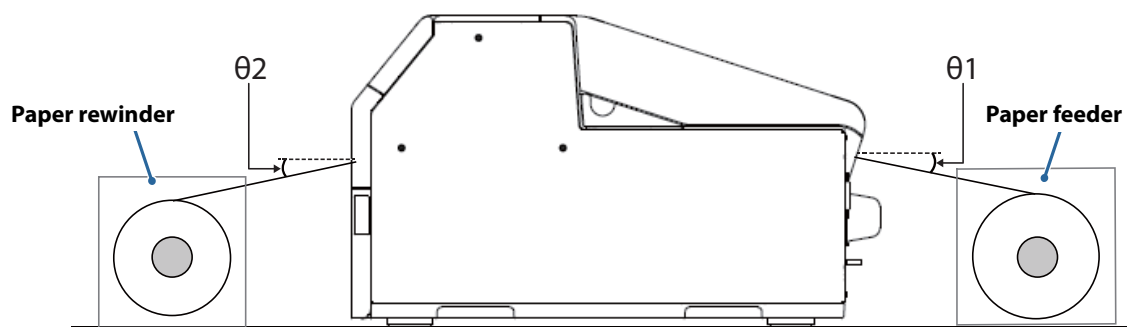

Angle for paper feeding: $\theta_1$	$15^\circ \leq \theta_1 \leq 30^\circ$
Angle for ejecting paper: $\theta_2$	$0^\circ \leq \theta_2 \leq 20^\circ$

### Peeler Model

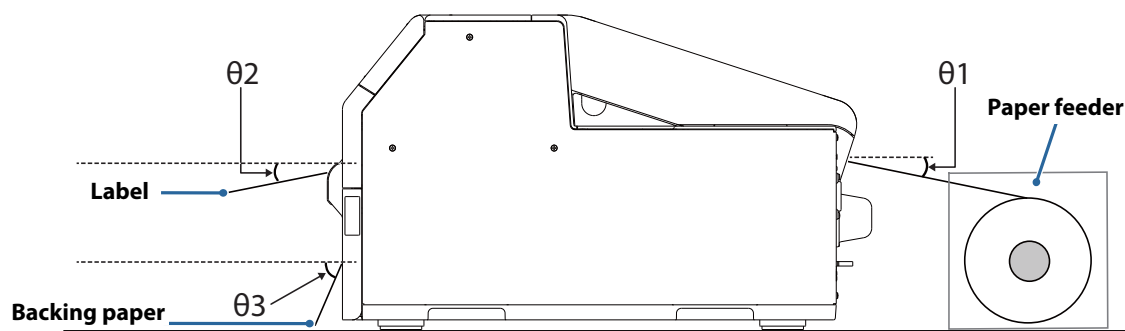

Angle for paper feeding: $\theta_1$	$15^\circ \leq \theta_1 \leq 30^\circ$
Angle for ejecting paper after peeling off the backing paper: $\theta_2$	$0^\circ \leq \theta_2 \leq 45^\circ$ (depends on stiffness of the paper)
Angle for rewinding the backing paper: $\theta_3$	$45^\circ \leq \theta_3 \leq 90^\circ$

## Position of Paper Feeder and Paper Rewinder

Place a paper feeder and paper rewriter so that paper is fed or ejected straight to/from the printer.

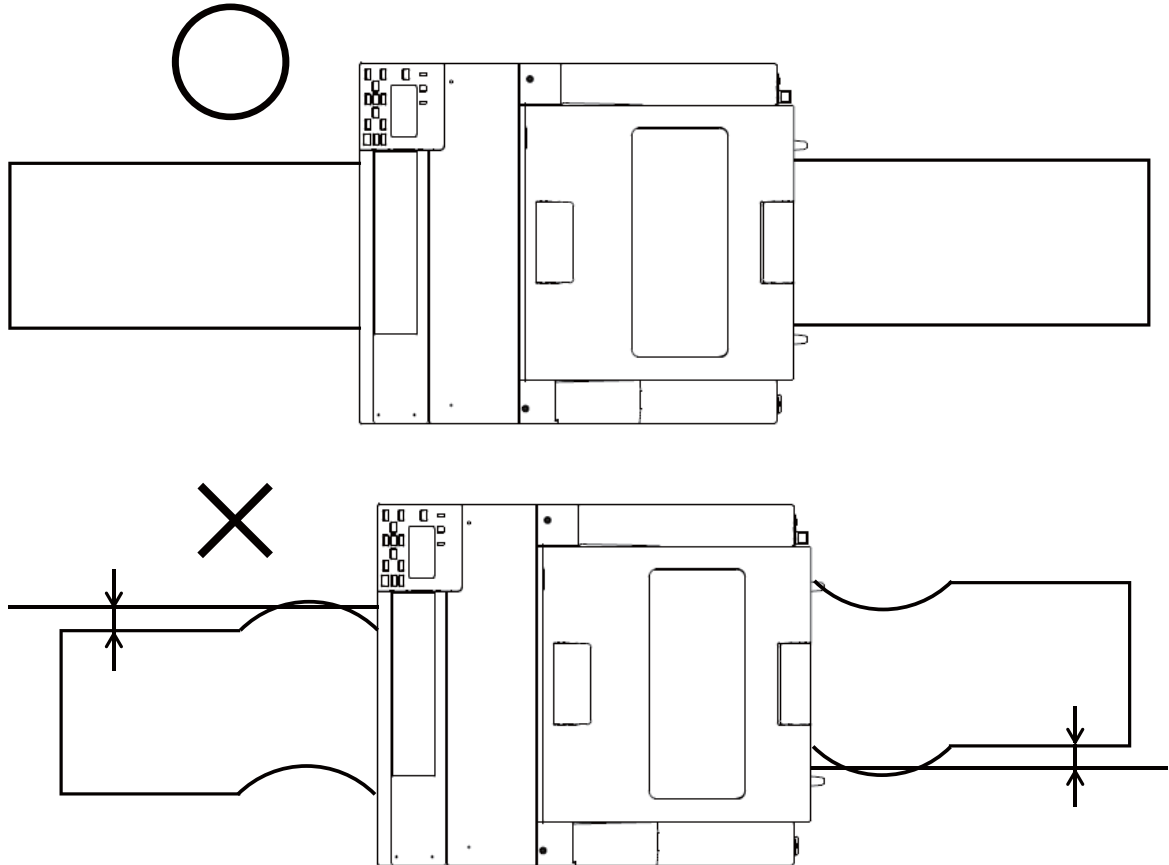

If you find that paper is skewed before it reaches the printer or rewriter, adjust the position of the paper feeder or the paper rewriter.

## Downloading Printer Driver, Utilities, and Manuals

The latest versions of the printer driver, utilities, and manuals can be downloaded from the following URLs.

For customers in North America, go to the following web site:

<https://www.epson.com/support/>

For customers in other countries and regions, go to the following web site:

<https://epson.sn>

## Label Print Applications

Some commercially available label print applications offer a printer driver for this printer allowing you to use the printer easily from the applications. By using the printer driver, you can make the printer settings and use the printer functions.

When you use the printer driver, you do not need to use the Epson printer driver.

The label print applications that offer a printer driver for this printer are listed below.

- BarTender
- NiceLabel
- CODESOFT

### How to Get Software

BarTender

<https://www.seagullscientific.com/>

NiceLabel

<https://www.loftware.com/>

CODESOFT

<https://www.teklynx.com/>

## For Inquiries

If you have any technical questions about this printer, or if any problems occur, please contact us with the following information.



- Contents of technical questions must be about our printers only. For those about products of Microsoft Corporation or other companies, please contact them.
- If any problems occur, check whether there is any physical cause (such as connection or power problems) before contacting us.

- Type of inquiry: Problem / Question
- Date:
- Your company:
- Department:
- Your name:
- Phone/Fax/Email:
- Computer information:
  - Manufacturer
  - CPU
- OS (with Service Pack information):
- Model name of the printer:
- Printer driver: Installed (OS driver or Epson driver) / Not installed
- Connection type: USB / Ethernet / MS shared (Client / Server)
- Firewall: OS standard / Personal (Product name/Ver.) / None
- Your application information:
  - Windows service operation / Normal EXE operation
- EPSON application status: EpsonNet WebManager / EpsonNet Log Browser / Epson Monitoring Tool / EpsonNet Simple Viewer / EpsonNet SDK for Windows / Printer Setting / Other (Application name)
- Phenomenon of the problem (or content of the question):
- System configuration: Hardware configuration such as computer and network, and Software module configuration
- Procedure of reproduction of the problem: Operation procedure, functional procedure, function and argument value to reproduce
- Reproducibility of the problem: Yes (    out of    times) / No