

CW-C8000 Series

External I/O

Technical Reference Guide

Overview

External I/O Specification

Commands

Printer Statuses and Signals

Timing

External I/F Signal Operation Mode Settings

Appendix

Cautions

- No part of this document may be reproduced, stored in a retrieval system, or transmitted in any form or by any means, electronic, mechanical, photocopying, recording, or otherwise, without the prior written permission of Seiko Epson Corporation.
- The contents of this document are subject to change without notice. Please contact us for the latest information.
- While every precaution has been taken in the preparation of this document, Seiko Epson Corporation assumes no responsibility for errors or omissions.
- Neither is any liability assumed for damages resulting from the use of the information contained herein.
- Neither Seiko Epson Corporation nor its affiliates shall be liable to the purchaser of this product or third parties for damages, losses, costs, or expenses incurred by the purchaser or third parties as a result of: accident, misuse, or abuse of this product or unauthorized modifications, repairs, or alterations to this product, or (excluding the U.S.) failure to strictly comply with Seiko Epson Corporation's operating and maintenance instructions.
- Seiko Epson Corporation shall not be liable against any damages or problems arising from the use of any options or any consumable products other than those designated as Original EPSON Products or EPSON Approved Products by Seiko Epson Corporation.

Trademarks

All trademarks are the property of their respective owners and used for identification purposes only.

©Seiko Epson Corporation 2024

Restriction of Use

When this product is used for applications requiring high reliability/safety such as transportation devices related to aviation, rail, marine, automotive etc.; disaster prevention devices; various safety devices etc.; or functional/precision devices etc., you should use this product only after giving consideration to including fail-safes and redundancies into your design to maintain safety and total system reliability. Because this product was not intended for use in applications requiring extremely high reliability/safety such as aerospace equipment, main communication equipment, nuclear power control equipment, or medical equipment related to direct medical care etc., please make your own judgment on this product's suitability after a full evaluation.

About this Manual

Aim of the Manual

This manual was created to provide information on development, design, and installation of systems and development and design of printer applications for developers.





Manual Content

The manual is made up of the following sections:

Chapter 1	Overview
Chapter 2	External I/O Specification
Chapter 3	Commands
Chapter 4	Printer Statuses and Signals
Chapter 5	Timing
Chapter 6	External I/F Signal Operation Mode Settings
Chapter 7	Appendix

Key to Symbols

The symbols in this manual are identified by their level of importance, as defined below. Read the following carefully before handling the product.

 WARNING	<p>You must follow warnings carefully to avoid serious bodily injury.</p>
 CAUTION	<p>Provides information that must be observed to prevent damage to the equipment or loss of data.</p> <ul style="list-style-type: none"> • Possibility of sustaining physical injuries. • Possibility of causing physical damage. • Possibility of causing information loss.
 IMPORTANT	<p>Indicates information with which you must comply when using the product. Mishandling due to ignoring this information may cause the product to fail or malfunction.</p>
 NOTE	<p>Indicates supplementary explanations and information you should know.</p>

Safety Precautions on Handling

 WARNING	<ul style="list-style-type: none"> • Shut down your equipment immediately if it produces smoke, a strange odor, or unusual noise. Continued use may lead to fire or electric shock. Immediately unplug the equipment. • Only disassemble this product as described in this manual. Do not make modifications to the unit. Tampering with this product may result in injury, fire, or electric shock. • Never insert or disconnect the power plug with wet hands. Doing so may result in severe shock. • Do not allow foreign matter to fall into the equipment. Penetration by foreign objects may lead to fire or shock. • If water or other liquid spills into this equipment, unplug the power cord immediately. Continued usage may lead to fire or shock. • Handle the power cord with care. Improper handling may lead to fire or shock. <ul style="list-style-type: none"> * Do not modify or attempt to repair the cord. * Do not place any object on top of the cord. * Avoid excessive bending, twisting, and pulling. * Do not place cord near heating equipment. * Check that the plug is clean before plugging it in. * Be sure to push the prongs all the way in. • Be sure to set this equipment on a firm, stable, horizontal surface. Product may break or cause injury if it falls. • Do not use in locations subject to high humidity or dust levels. Excessive humidity and dust may cause equipment damage, fire, or shock. • Do not place heavy objects on top of this product. Never stand or lean on this product. Equipment may fall or collapse, causing breakage and possible injury.
--	--

Contents

■ Restriction of Use	3
■ About this Manual	3
Aim of the Manual	3
Manual Content.....	3
Key to Symbols.....	4
Safety Precautions on Handling	4
■ Contents.....	5

Overview..... 8

■ Functionality	8
■ External device	9

External I/O Specification 10

■ Connector	10
■ Signal Definitions.....	10
Pulse signal.....	10
Level signal.....	11
■ Pin Assignment and Specification for I/O Signals.....	12
■ I/O Signal Specifications	16
Figure of Jumper Settings and I/O Power (VCC_EX) and Ground Connections	16

Commands20

■ List of Commands	20
■ Setting Commands	24
End print signal (output) mode settings	24
Mode setting for data ready signal (output)	26
Mode setting for clogged nozzle detected signal (output).....	27
Mode setting for head maintenance signal (output).....	28
Mode setting for printer ready signal (output)	29
Mode setting for warning signal (output).....	30
Mode setting for error & pause signal (output).....	31
Ink low signal (output) mode setting	32
Ink cartridge exchange signal (output) mode setting.....	33
Paper out signal (output) mode setting	34
Mode setting for pause signal (input)	35
Mode setting for head cleaning signal (input)	36
Mode setting for clogged nozzle check signal (input)	37
Mode setting for feed signal (input).....	38

Mode setting for start print signal (input).....	39
Mode setting for re-print signal (input)	40
■ Acquisition Commands for Setting Values.....	41
Acquisition commands for mode setting values for end print signal (output)	41
Acquisition commands for mode setting values for data ready signal (output)	41
Acquisition commands for mode setting values for clogged nozzle detected signal (output)	42
Acquisition commands for mode setting values for head maintenance signal (output)	42
Acquisition commands for mode setting values for printer ready signal (output).....	43
Acquisition commands for mode setting values for warning signal (output)	43
Acquisition commands for mode setting values for error & pause signal (output).....	44
Acquisition of mode setting value for ink low signal (input)	44
Acquisition of mode setting value for ink cartridge exchange signal (input).....	45
Acquisition command of mode setting value for paper out signal (input)	45
Acquisition commands for mode setting values for pause signal (input).....	46
Acquisition commands for mode setting values for head cleaning signal (input)	46
Acquisition commands for mode setting values for clogged nozzle check signal (input).....	46
Acquisition commands for mode setting values for feed signal (input).....	47
Acquisition commands for mode setting values for start print signal (input).....	47
Acquisition commands for mode setting values for re-print signal (input)	47

Printer Statuses and Signals.....48

Timing49

■ Basic Timing for Label Printing.....	49
■ Basic Timing for Pausing.....	50
■ Basic Timing for Label Feeding.....	51
■ Basic Timing for Nozzle Check and Head Cleaning	52

External I/F Signal Operation Mode Settings54

■ End Print Signal Mode Settings.....	54
■ Data Ready Signal Mode Settings.....	54
■ Clogged Nozzle detected Signal Mode Settings.....	55
■ Head Maintenance Signal Mode Settings	55
■ Printer Ready Signal Mode Settings.....	55
■ Warning Signal Mode Settings	56
■ Error & Pause Signal Mode Settings	56
■ Ink Low Signal Mode Settings	56
■ Ink Cartridge Exchange Signal Mode Settings.....	57
■ Paper Out Signal Mode Settings	57

■ Mode Setting for Pause Signal	57
■ Mode Setting for Head Cleaning Signal	57
■ Mode Setting for Clogged Nozzle Check Signal.....	58
■ Mode Setting for Feed Signal	58
■ Mode Setting for Start Print Signal.....	58
■ Mode Setting for Re-print Signal	58

Appendix.....59

■ Cautions for Setting Jumpers	59
■ Switching the I/O Power (VCC_EX) and SG.....	60
■ FAQ.....	63

Overview

This guide describes the external I/O specifications for the CW-C8000 Series. Please develop your device to match these specifications.

Functionality

Using the external I/O signal allows the user to perform synchronous control of the printer and external devices and to check the printer status.

Signal transmission between the printer and external device uses a D-Sub 25 cable.

In addition, commands to configure the operation of the external I/O are sent from the host PC via USB or Ethernet. When sending commands over the Ethernet, use port 9100.

System structure

A system using the external I/O can be structured as follows.

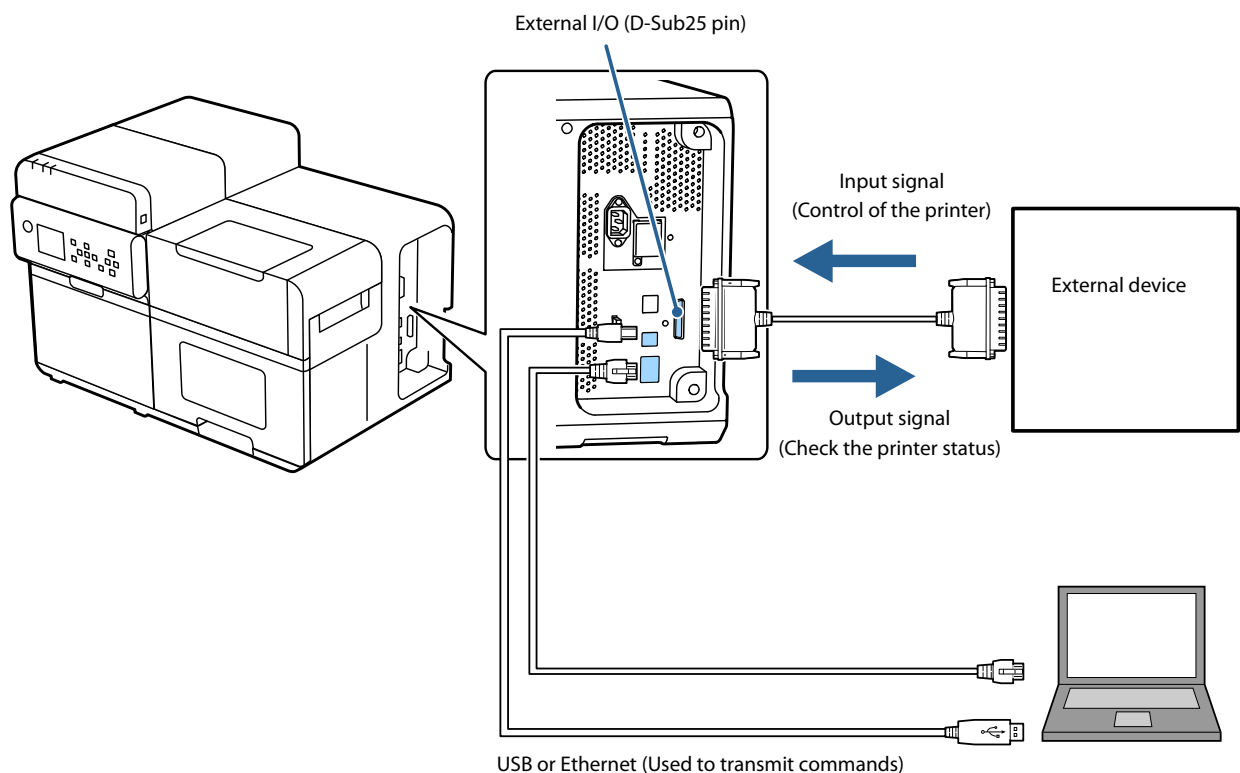

External device

The following external devices can be connected.

- Automatic application machine
- Roll rewinder
- Devices that must sync with the printer other than the above

**NOTE**

The number of possible connections is one.

External I/O Specification

This section describes the external I/O for the printer.

Connector

The external I/O connectors are as follows.

D-sub25 connector (female connector)

Screws: Metric screws

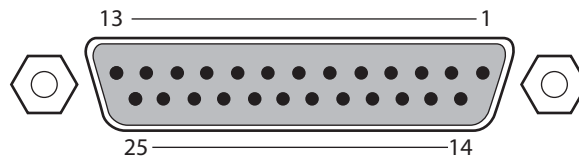

NOTE

Be sure to use the screws to affix the connection cable and ensure the cable does not fall out.

Signal Definitions

Pulse signal

A pulse signal is a square wave with a fixed short-term width. A low active pulse is a signal that changes sharply from High to Low, maintains a low state for a short period of time, and then sharply changes back to High. A High active pulse is a signal that changes sharply from Low to High, maintains a High state for a short period of time, and then sharply changes back to Low.

If a pulse signal meets the specification for pulse width, the time for the pulse width does not matter.

Pulse width of input signal

As shown in below, input pulse signals that can be received must have a pulse width of 30 msec or more.

Maintain the low state stable for a pulse width of 30 msec.

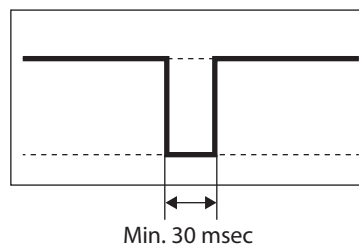

CAUTION

Pulse widths of less than 30 msec can also be received.

Minimum interval between input pulse signals

As shown below, the interval between input pulse signals that can be received should be 50 ms or more.

Proper operation cannot be guaranteed if the input pulse signal is less than 50 msec.

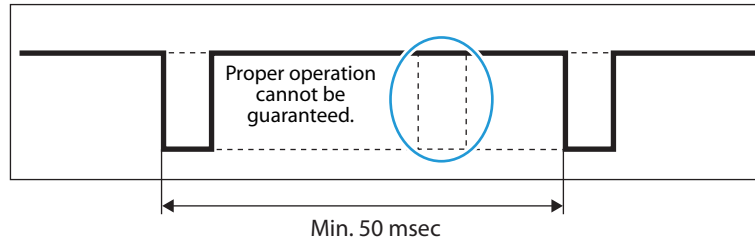

Level signal

A level signal is a signal that maintains a Low and/or High state for a certain length of time, and refers to the time during which that state is maintained. A Low active level signal changes from High to Low, and the time during which it maintains the Low state is the active state. A High active level signal changes from Low to High, and the time during which it maintains the High state is the active state. If both Low and High are significant, both the Low state and the High state are each maintained for a certain length of time.

Minimum time input level signals that can be received are maintained

As shown below, input level signals that can be received must be maintained for 30 msec or more.

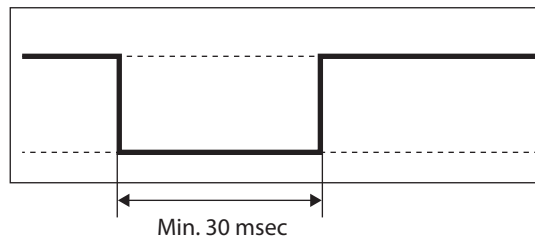

Pin Assignment and Specification for I/O Signals

The pin assignment and specification for I/O signals are shown below.

Perform settings so that the specifications of the printer and external device match.

Pin	Signal	Input-Output *1	Pulse/Level	Description
1	Signal Ground	-	-	Ground for I/O signals. Set a jumper on CN100 to keep Signal Ground and Frame Ground separate.
2	Reserved	-	-	This signal is reversed for the system.
3	Reserved	-	-	
4	Reserved	-	-	
5	Reserved	-	-	
6	Reserved	-	-	
7	Signal Ground	-	-	Ground for I/O signals. Set a jumper on CN100 to keep Signal Ground and Frame Ground separate.
8	Ink Low *2	Output	Level	Indicates whether the printer is in an ink low state. <ul style="list-style-type: none"> • L: Ink low • H: No ink low
9	I/O Power (VCC_EX)	-	-	Provides 5 V ($\pm 10\%$) power supply to external devices. The maximum current that can be provided is 180 mA. This pin can receive I/O power from an external I/O power supply with a jumper setting on CN200, while also keeping Signal Ground and Frame Ground separate.
10	Start print *3, 4	Input	Pulse/Level	Sends an instruction to start printing. <ul style="list-style-type: none"> • In pulse mode, printing starts if a change from High to Low is detected. Detection occurs only when the state of the "End print" signal is High, and does not occur while printing is in progress. To print a new label, first return the signal to High, and then change it again from High to Low. • In level mode, printing starts if this signal is Low. Detection occurs only when the state of the "End print" signal is High. Printing of new labels will continue until Low is detected. • Signal logic: Low active

Pin	Signal	Input-Output *1	Pulse/Level	Description
11	Feed *3	Input	Level	<p>Sends an instruction to feed the paper.</p> <ul style="list-style-type: none"> When the printer is in the Ready or Pause state, the printer feeds paper if this signal is Low. For labels, if this signal changes to High while the printer is feeding paper, feeding will stop when the edge of the next label is detected. For continuous paper, if this signal changes to High while the printer is feeding paper, feeding will stop after the detection time has elapsed. Signal logic: Low active
12	Pause *3	Input	Pulse	<p>Sends an instruction to pause the printer.</p> <ul style="list-style-type: none"> The printer is paused if a change from High to Low is detected. While the printer is paused, if a change from High to Low is detected again, the printer will be unpaused. Signal logic: Low active
13	Re-print *3	Input	Pulse	<p>If the label reprinting function is enabled, an instruction to reprint the label that was last printed is sent from an external device.</p> <ul style="list-style-type: none"> The label is reprinted if a change from High to Low is detected. Signal logic: Low active
14	Clogged nozzle check *3*5	Input	Pulse	<p>Sends an instruction to check the head for a clogged nozzle.</p> <ul style="list-style-type: none"> The head is checked for a clogged nozzle if a change from High to Low is detected. Signal logic: Low active
15	Head Cleaning *3	Input	Pulse	<p>Sends an instruction for head cleaning.</p> <ul style="list-style-type: none"> The head is cleaned if a change from High to Low is detected. Signal logic: Low active
16	Warning *2	Output	Level	<p>Indicates whether the printer is in a warning state.</p> <ul style="list-style-type: none"> L: Warning H: No warning

Pin	Signal	Input-Output *1	Pulse/Level	Description
17	Error & pause	Output	Level	<p>Indicates that the printer is in an error state, or that the printer is in an error state or a paused state.</p> <ul style="list-style-type: none"> • Mode 0: Off • Mode 1: Normal: High, When an error occurs: Low • Mode 2: Normal: Low, When an error occurs: High • Mode 3: Normal: High, When an error occurs or the printer is paused: Low • Mode 4: Normal: Low, When an error occurs or the printer is paused: High
18	End print *2 *4	Output	Pulse/Level	<p>The meaning of this signal varies depending on the values that are set for end print signal mode, as indicated below.</p> <ul style="list-style-type: none"> • Mode 0: End print signal OFF (End print signal not output) • Mode 1: Indicates that the printer feeds paper during Low. • Mode 2: Indicates that the printer feeds paper during High. • Mode 3 (default): Indicates that, for a pulse with a Low duration of 20 msec, printing ends and the printer feeds paper to the predetermined position. • Mode 4: Indicates that, for a pulse with a High duration of 20 msec, printing ends and the printer feeds paper to the predetermined position.
19	Printer ready *2	Output	Level	<p>Indicates whether the printer is in the ready state.</p> <ul style="list-style-type: none"> • L: Ready • H: Not Ready
20	Reserved	-	-	This signal is reversed for the system.
21	Head maintenance *2	Output	Level	<p>Indicates whether the printer is undergoing head maintenance. During head maintenance, the printer is undergoing either a nozzle check or head cleaning.</p> <ul style="list-style-type: none"> • L: Head maintenance in progress • H: Head maintenance not in progress

Pin	Signal	Input-Output *1	Pulse/Level	Description
22	Ink cartridge exchange ^{*2}	Output	Level	Indicates whether the printer requires an ink cartridge exchange. <ul style="list-style-type: none"> • L: Ink cartridge exchange required • H: Ink cartridge exchange not required
23	Data ready ^{*2}	Output	Level	Indicates that the generation of print data has completed in the printer. <ul style="list-style-type: none"> • L: Print data preparation complete • H: Print data preparation not complete
24	Clogged nozzle detected ^{*2*5}	Output	Level	Indicates whether the printer has detected a clogged nozzle in the head. <ul style="list-style-type: none"> • L: Clogged nozzle detected • H: Clogged nozzle not detected <p>* The results of the previous nozzle check are applied.</p> <p>* Even if nozzle clogging is not specified (when a nozzle check is not performed, or if a warning occurs while the state of the nozzles is unclear), the value at that time is maintained.</p>
25	Paper out ^{*2}	Output	Level	Indicates whether the printer is in a paper out state. <ul style="list-style-type: none"> • L: Paper out • H: No paper out

*1 Input and output directions are described as viewed from the printer.

Input: Signal input to the printer from an external device.

Output: Signal output from the printer to an external device.

*2 The logic for output signals can be reversed.

The information provided in the Description column is based on the default signal logic.

If the signal logic is reversed, it will be the opposite.

*3 The logic for input signals is low active. (The logic for input signals cannot be reversed.)

*4 The "Start print" signal and "End print" signal can be switched between pulse and level.

*5 The results of the previous nozzle check are applied to the clogged nozzle detected signal (pin 24). Therefore, during a nozzle check, issue a nozzle check command (pin 14) before checking the clogged nozzle detected signal (pin 24). Refer to timing "[Timing](#)" on page 49.

I/O Signal Specifications

Figure of Jumper Settings and I/O Power (VCC_EX) and Ground Connections

Depending on the usage environment at the customer place, the structure allows the I/O power (VCC_EX) and Signal Ground (SG) to be separated from the Frame Ground (FG). The following describes the jumper settings and I/O power (VCC_EX) and ground connections.

State	CN100 JP setting	CN200 JP setting
I/O Power/SG not separated	1-2 pin shorted	1-2 pin shorted
I/O Power/SG separated	2-3 pin shorted	2-3 pin shorted



IMPORTANT

- When shorting pins 1 and 2 on CN100, DO NOT short pins 2 and 3 on CN200.
- When shorting pins 2 and 3 on CN100, DO NOT short pins 1 and 2 on CN200.



NOTE

When separating the I/O power and signal ground, the printer cannot provide a 5 V power supply to an external device.

I/O power (VCC_EX) and SG are not separated

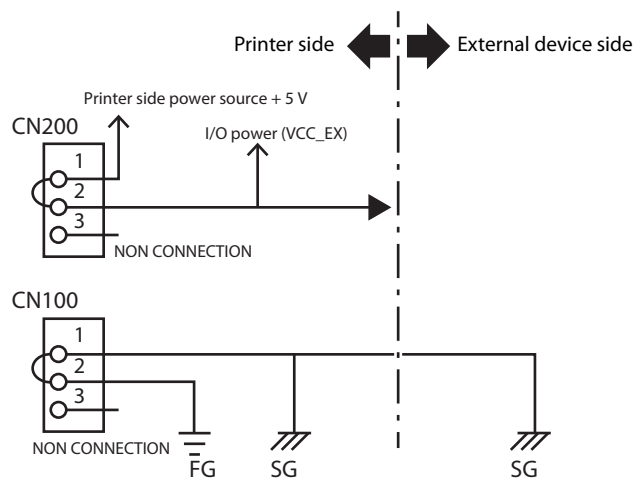

I/O power (VCC_EX)/SG separated

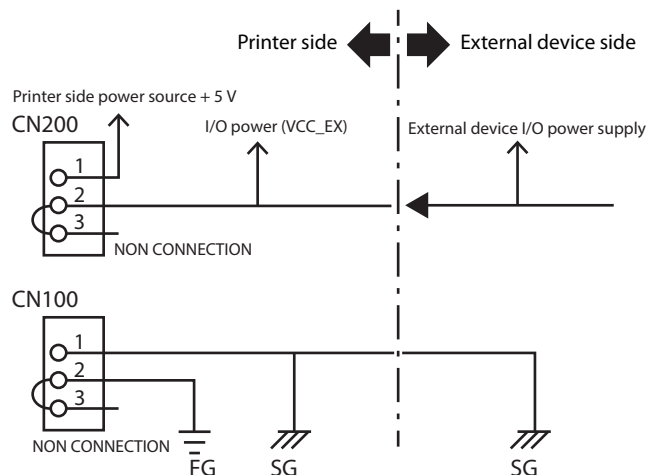

I/O Signal Specifications

 CAUTION	<ul style="list-style-type: none"> • Regardless of whether an external device is connected or the connected external device is turned on or off, when the printer is turned on, the voltage and signal are output from the I/O power (VCC_EX) pin and output signal pin of the external I/O connector. Connect an external device under this assumption. • If connecting to an external device, make sure that the printer I/O power (VCC_EX) and external device I/O power are the same voltage. <ul style="list-style-type: none"> * When I/O power (VCC_EX) and SG are not separated The I/O power (VCC_EX) on the printer side is 5 V. Use 5 V also for the I/O power on the external device side. * When I/O power (VCC_EX) and SG are separated The printer side I/O power (VCC_EX) is the voltage supplied from the external device side. Use this same voltage for the I/O power on the external device side. • If connecting an inductive load such as a relay, use one equipped with a surge protection circuit.
--	--

 NOTE	<p>The I/O terminals are indefinite during the following conditions.</p> <ul style="list-style-type: none"> • When I/O power (VCC_EX) and SG are not separated <ul style="list-style-type: none"> * Immediately after turning the power on * During power off processing * When the power is off • When I/O power (VCC_EX) and SG are separated <ul style="list-style-type: none"> * Before providing I/O power on printer side
---	---

Specification for I/O Signals (I/O Power (VCC_EX)/SG Not Separated)

Input/Output	Item	Value
Input signal to the printer	Input port on the printer	Support for an open drain or open collector output
	Low level	VIL_max. 0.8 V Sink current Min. 0.6 mA Max. 1.3 mA ^{*1}
	High level (Allowable leakage current)	Max. 100 uA
Output signal from printer	Output port on the printer	Open drain output (pull-up resistor is on the printer)
	Low level	VOL_max. 0.8 V Sink current Max. 50 mA ^{*2}
	High level	VOH_min. 4.0 V ^{*3} Leakage currentMax. 50 uA

*1 The sink current is limited by the current limiting resistor (R = 4.3 kΩ).

*2 The current must be limited on the external device side so that the sink current does not exceed 50 mA. When driving with multiple terminals, the total sink current must be within 180 mA.

*3 This voltage depends on the pull-up resistance (R_{pu} = 10 kΩ) of the printer and the input resistance of the external device.

Example input signal circuit

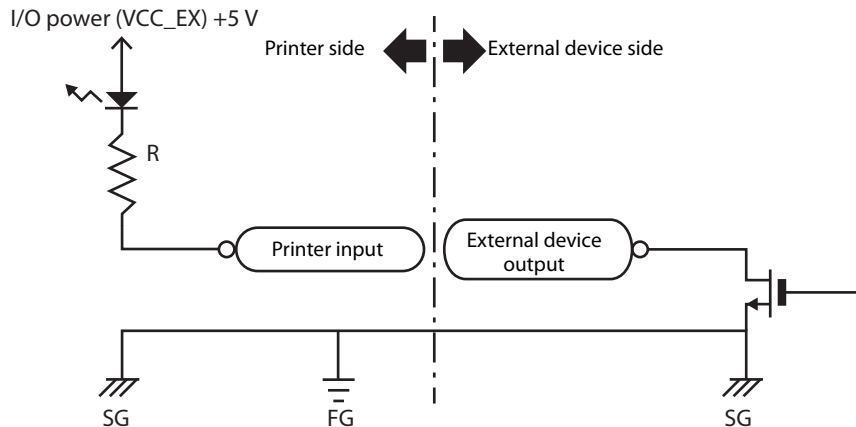

Example output signal circuit

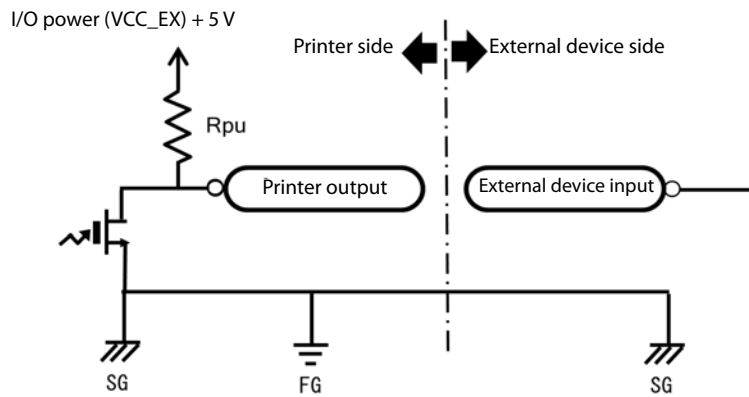

Specification for I/O Signals (I/O Power (VCC_EX)/SG Separated)

Input/Output	Item	Value
Input signal to the printer	Input port on the printer	Support for an open drain or open collector output
	I/O power (VCC_EX) Voltage range	5–28 V
	Low level	VIL_max. 0.8 V VIL_max. 1.5 V (When VCC_EX = 12–28 V) Sink current Min. 0.6 mA Max. 6.6 mA *1
	High level (Allowable leakage current)	Max. 100 uA
Output signal from printer	Output port on the printer	Open drain output (pull-up resistor is on the printer)
	I/O power (VCC_EX) Voltage range	5–28 V
	Low level	VOL_max. 0.8 V Sink current Max. 50 mA *2
	High level	VOH_min. VCC_EX * 0.8 V *3 Leakage current Max. 50 uA

- *1 The sink current is limited by the current limiting resistor ($R = 4.3 \text{ k}\Omega$).
- *2 The current must be limited on the external device side so that the sink current does not exceed 50 mA.
- *3 This voltage depends on the pull-up resistance ($R_{pu} = 10 \text{ k}\Omega$) of the printer and the input resistance of the external device.

Example input signal circuit

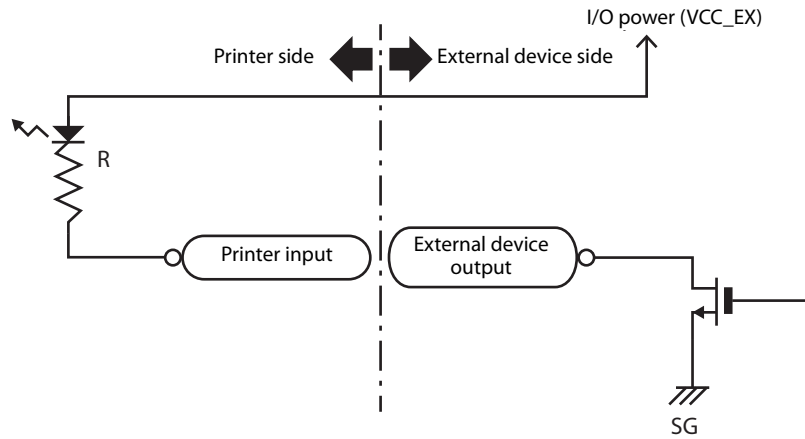

Example output signal circuit

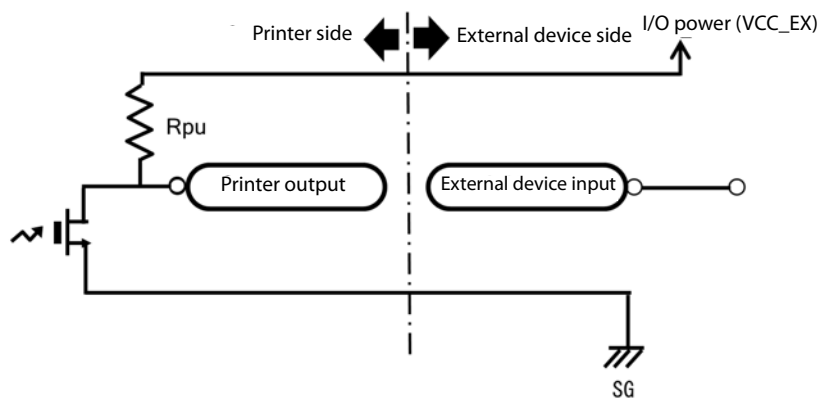

Commands

This section describes the commands of the external I/O. You can acquire each signal's mode settings and printer setting values.

List of Commands

The signal specifications for the external I/O are as follows.

No.	Command name category	Command function	Command and parameters
1	External I/O output signal settings	End print signal mode setting	$\wedge S(CNA,B,c$ $c = D/E/N/0/1/2/3/4$ 0/D: End print signal OFF (End print signal not output) 1: Normal: High, When feeding paper: Low 2/E: Normal: Low, When feeding paper: High 3: Normal: High, For 20 msec after printing: Low 4/N: Normal: Low, For 20 msec after printing: High
2		Data ready signal mode setting	$\wedge S(CNA,A,c$ $c = D/E/0/1/2$ 0/D: Off 1: Normal: High, When an event occurs: Low 2/E: Normal: Low, When an event occurs: High
3		Clogged nozzle detected signal mode setting	$\wedge S(CNA,D,c$ $c = D/E/0/1/2$ 0/D: Off 1: Normal: High, When an event occurs: Low 2/E: Normal: Low, When an event occurs: High
4		Head maintenance mode setting	$\wedge S(CNA,M,c$ $c = D/E/0/1/2$ 0/D: Off 1: Normal: High, When an event occurs: Low 2/E: Normal: Low, When an event occurs: High
5		Printer ready signal mode setting	$\wedge S(CNA,O,c$ $c = D/E/0/1/2$ 0/D: Off 1: Normal: High, When an event occurs: Low 2/E: Normal: Low, When an event occurs: High
6		Warning signal mode setting	$\wedge S(CNA,W,c$ $c = D/E/0/1/2$ 0/D: Off 1: Normal: High, When an event occurs: Low 2/E: Normal: Low, When an event occurs: High

No.	Command name category	Command function	Command and parameters
7	External I/O output signal settings	Error & pause signal mode setting	$\wedge S(CNA,E,c$ $c= D/E/N/0/1/2/3/4$ 0/D: Off 1: Normal: High, When an error occurs: Low 2/E: Normal: Low, When an error occurs: High 3: Normal: High, When an error occurs or the printer is paused: Low 4/N: Normal: Low, When an error occurs or the printer is paused: High
8		Ink low signal mode setting	$\wedge S(CNA,J,c$ $c= D/E/0/1/2$ 0/D: Off 1: Normal: High, When there is little ink remaining: Low 2/E: Normal: Low, When there is little ink remaining: High
9		Ink cartridge exchange signal mode setting	$\wedge S(CNA,I,c$ $c= D/E/0/1/2$ 0/D: Off 1: Normal: High, When ink must be replaced: Low 2/E: Normal: Low, When ink must be replaced: High
10		Paper out signal mode setting	$\wedge S(CNA,P,c$ $c= D/E/0/1/2$ 0/D: Off 1: Normal: High, When there is no paper: Low 2/E: Normal: Low, When there is no paper: High

No.	Command name category	Command function	Command and parameters
11	External I/O input signal settings	Pause signal mode setting	^S(CNI,P,c c= 0/1 0: Ignore pause signal. 1: Switch the pause state if Low is asserted for the pause signal for 30 msec or longer.
12		Head cleaning signal mode setting	^S(CNI,C,c c= 0/1 0: Ignore cleaning signal. 1: Clean if Low is asserted for the cleaning signal for 30 msec or longer.
13		Clogged nozzle check signal mode setting	^S(CNI,D,c c= 0/1 0: Ignore clogged nozzle check signal. 1: Check for clogged nozzle if Low is asserted for the clogged nozzle check signal for 30 msec or longer.
14		Feed signal mode setting	^S(CNI,F,c c= 0/3 0: Ignore feed label signal. 3: Continue feeding the label as long as Low is asserted.
15		Mode setting for start print signal	^S(CNI,S,c c= 0/1/3 0: Ignore start print signal. (Normal print mode in which the printer receives and prints data, without using the start print signal input to the external I/O.) 1: Issue a label if Low is asserted for the start print signal for 30 msec or longer. 3: Continue issuing labels as long as Low is asserted for the start print signal.
16		Mode setting for re-print signal	^S(CNI,R,c c= 0/1 0: Ignore reprint label signal. 1: Reprint the previously printed label if Low is asserted for the reprint label signal for 30 msec or longer.

No.	Command name category	Command function	Command and parameters
17	Acquisition of setting values for external I/O output signal	Acquisition of mode setting values for end print signal	~H(CNA,B
18		Acquisition of mode setting values for data ready signal	~H(CNA,A
19		Acquisition of mode setting values for clogged nozzle detected signal	~H(CNA,D
20		Acquisition of mode setting values for head maintenance signal	~H(CNA,M
21		Acquisition of mode setting values for printer ready signal	~H(CNA,O
22		Acquisition of mode setting values for warning signal	~H(CNA,W
23		Acquisition of mode setting values for error & pause signal	~H(CNA,E
24		Acquisition of mode setting value for ink low signal	~H(CNA,J
25		Acquisition of mode setting value for ink cartridge exchange signal	~H(CNA,I
26		Acquisition of mode setting value for paper out signal	~H(CNA,P
27	Acquisition of setting values for external I/O input signal	Acquisition of setting values for pause signal	~H(CNI,P
28		Acquisition of setting values for head cleaning signal	~H(CNI,C
29		Acquisition of setting values for clogged nozzle check signal	~H(CNI,D
30		Acquisition of setting values for feed signal	~H(CNI,F
31		Acquisition of setting values for start print signal	~H(CNI,S
32		Acquisition of setting values for re-print signal	~H(CNI,R

Setting Commands

This section describes the commands for setting the external I/O.

End print signal (output) mode settings

[Format]

^S(CNA,B,c

[Parameter] c

Description	Definition range
c = Mode setting	D/E/N/0/1/2/3/4

[Function]

Configure the mode settings for the end print signal.

Value for parameter c	Description
D/0	Turn the end print signal OFF. (End print signal not output)
1	Set the end print signal (pin 18) as follows: Normal: High, When feeding paper: Low.
E/2	Set the end print signal (pin 18) as follows: Normal: Low, When feeding paper: High.
3	Set the end print signal (pin 18) as follows: Normal: High, When continuous printing ends and the printer stops at the predetermined position: Low for 20 msec.
N/4	Set the end print signal (pin 18) as follows: Normal: Low, When continuous printing ends and the printer stops at the predetermined position: High for 20 msec.

[Initial value]

0

[Signal timing]

<Mode 1>

Signal	Printer status					Signal status
	Sent label format	Processed label format	Standby for start signal	Print label	Ready to print next label	
Data preparation complete						Preparing Preparation complete
Start print						Do not start Start
End print						Not finished Finished

<Mode 2>

Signal	Printer status					Signal status
	Sent label format	Processed label format	Standby for start signal	Print label	Ready to print next label	
Data preparation complete						Preparing Preparation complete
Start print						Do not start Start
End print						Not finished Finished

<Mode 3>

Signal	Printer status					Signal status
	Sent label format	Processed label format	Standby for start signal	Print label	Ready to print next label	
Data preparation complete						Preparing Preparation complete
Start print						Do not start Start
End print						Not finished Finished

<Mode 4>

Signal	Printer status					Signal status
	Sent label format	Processed label format	Standby for start signal	Print label	Ready to print next label	
Data preparation complete						Preparing Preparation complete
Start print						Do not start Start
End print						Not finished Finished

[Examples of command transmissions]

Set the end print signal to "Normal: High, When feeding paper: Low".

The ^JUS command must be used to save the settings to the non-volatile memory in the printer.

An example of the command transmission is shown below. It is sent via USB or Ethernet from the computer.

```

^XA
^S(CNA,B,1
^JUS
^XZ

```

Mode setting for data ready signal (output)

[Format]

`^S(CNA,A,c`

[Parameter] `c`

Description	Definition range
<code>c = Mode setting</code>	D/E/0/1/2

[Function]

Configure the mode setting for the print data preparation complete (print data deployed) signal.

Value for parameter <code>c</code>	Description
D/0	Turn the data ready signal (pin 23) OFF (not output).
1	Set the data ready signal (pin 23) as follows: Normal: High, When print data preparation is complete: Low.
E/2	Set the data ready signal (pin 23) as follows: Normal: Low, When print data preparation is complete: High.

[Initial value]

0

[Examples of command transmissions]

Set the data ready signal to "Normal: High, When print data preparation is complete: Low".

The `^JUS` command must be used to save the settings to the non-volatile memory in the printer.

An example of the command transmission is shown below. It is sent via USB or Ethernet from the computer.

`^XA`

`^S(CNA,A,1`

`^JUS`

`^XZ`

Mode setting for clogged nozzle detected signal (output)

[Format]

^S(CNA,D,c

[Parameter] c

Description	Definition range
c = Mode setting	D/E/0/1/2

[Function]

Configure the mode setting for the clogged nozzle detected signal.

Value for parameter c	Description
D/0	Turn the clogged nozzle detected signal (pin 24) OFF (not output).
1	Set the clogged nozzle detected signal (pin 24) as follows: Normal: High, When nozzle clogged: Low.
E/2	Set the clogged nozzle detected signal (pin 24) as follows: Normal: Low, When nozzle clogged: High.

[Initial value]

0

[Examples of command transmissions]

Set the clogged nozzle detected signal to "Normal: High, When nozzle clogged: Low".

The ^JUS command must be used to save the settings to the non-volatile memory in the printer.

An example of the command transmission is shown below. It is sent via USB or Ethernet from the computer.

```

^XA
^S(CNA,D,1
^JUS
^XZ

```

Mode setting for head maintenance signal (output)

[Format]

^S(CNA,M,c

[Parameter] c

Description	Definition range
c = Mode setting	D/E/0/1/2

[Function]

Configure the mode setting for the head maintenance signal.

Value for parameter c	Description
D/0	Turn the head maintenance signal (pin 21) OFF (not output).
1	Set the head maintenance signal (pin 21) as follows: Normal: High, When head maintenance is in progress: Low.
E/2	Set the head maintenance signal (pin 21) as follows: Normal: Low, When head maintenance is in progress: High.

[Initial value]

0

[Examples of command transmissions]

Set the head maintenance signal to "Normal: High, When head maintenance is in progress: Low".

The ^JUS command must be used to save the settings to the non-volatile memory in the printer.

An example of the command transmission is shown below. It is sent via USB or Ethernet from the computer.

^XA

^S(CNA,M,1

^JUS

^XZ

Mode setting for printer ready signal (output)

[Format]

^S(CNA,O,c

[Parameter] c

Description	Definition range
c = Mode setting	D/E/0/1/2

[Function]

Configure the mode settings for the printer ready signal.

Value for parameter c	Description
D/0	Turn the printer ready signal (pin 19) OFF (not output).
1	Set the printer ready signal (pin 19) as follows: Normal: High, When printer is ready: Low.
E/2	Set the printer ready signal (pin 19) as follows: Normal: Low, When printer is ready: High.

[Initial value]

0

[Examples of command transmissions]

Set the printer ready signal to "Normal: High, When printer is ready: Low".

The ^JUS command must be used to save the settings to the non-volatile memory in the printer.

An example of the command transmission is shown below. It is sent via USB or Ethernet from the computer.

```
^XA
^S(CNA,O,1
^JUS
^XZ
```

Mode setting for warning signal (output)

[Format]

^S(CNA,W,c

[Parameter] c

Description	Definition range
c = Mode setting	D/E/0/1/2

[Function]

Configure the mode settings for the warning signal.

Value for parameter c	Description
D/0	Turn the warning signal (pin 16) OFF (not output).
1	Set the warning signal (pin 16) as follows: Normal: High, When a warning occurs: Low.
E/2	Set the warning signal (pin 16) as follows: Normal: Low, When a warning occurs: High.

[Initial value]

0

[Examples of command transmissions]

Set the warning signal to "Normal: High, When a warning occurs: Low".

The ^JUS command must be used to save the settings to the non-volatile memory in the printer.

An example of the command transmission is shown below. It is sent via USB or Ethernet from the computer.

```
^XA
^S(CNA,W,1
^JUS
^XZ
```

Mode setting for error & pause signal (output)

[Format]

^S(CNA,E,c

[Parameter] c

Description	Definition range
c = Mode setting	D/E/N/0/1/2/3/4

[Function]

Configure the mode settings for the error & pause signal.

If the value of parameter c (mode setting) is 3 or 4, the operation is the same as the service required signal for the external I/F of a Zebra printer.

Value for parameter c	Description
D/0	Turn the error & pause signal (pin 17) OFF (not output).
1	Set the error & pause signal (pin 17) as follows: Normal: High, When an error occurs: Low.
E/2	Set the error & pause signal (pin 17) as follows: Normal: Low, When an error occurs: High.
3	Set the error & pause signal (pin 17) as follows: Normal: High, When an error occurs or the printer is paused: Low.
N/4	Set the error & pause signal (pin 17) as follows: Normal: Low, When an error occurs or the printer is paused: High.

[Initial value]

0

[Examples of command transmissions]

Set the error & pause signal to "Normal: High, When an error occurs: Low".

The ^JUS command must be used to save the settings to the non-volatile memory in the printer.

An example of the command transmission is shown below. It is sent via USB or Ethernet from the computer.

```
^XA
^S(CNA,E,1
^JUS
^XZ
```

Ink low signal (output) mode setting

[Format]

`^S(CNA,J,c`

[Parameter] `c`

Description	Definition range
<code>c = Mode setting</code>	D/E/0/1/2

[Function]

This sets the ink low signal mode setting.

Value for parameter <code>c</code>	Description
D/0	Turns the ink low signal (pin 8) OFF (not output).
1	Sets the ink low signal (pin 8) as follows: Normal: High, When there is little ink remaining: Low.
E/2	Sets the ink low signal (pin 8) as follows: Normal: Low, When there is little ink remaining: High.

[Initial value]

0

[Examples of command transmissions]

The ink low signal is set to the mode that is high in the normal status, and low when there is little ink remaining.

The `^JUS` command must be used to save the settings to the non-volatile memory in the printer.

An example of the command transmission is shown below. It is sent via USB or Ethernet from the computer.

`^XA`

`^S(CNA,J,1`

`^JUS`

`^XZ`

Ink cartridge exchange signal (output) mode setting

[Format]

^S(CNA,I,c

[Parameter] c

Description	Definition range
c = Mode setting	D/E/0/1/2

[Function]

This sets the ink cartridge exchange signal mode setting.

Value for parameter c	Description
D/0	Turns the ink cartridge exchange signal (pin 22) OFF (not output).
1	Sets the ink cartridge exchange signal (pin 22) as follows: Normal: High, When ink must be replaced: Low.
E/2	Sets the ink cartridge exchange signal (pin 22) as follows: Normal: Low, When ink must be replaced: High.

[Initial value]

0

[Examples of command transmissions]

The ink cartridge exchange signal is set to the mode that is high in the normal status, and low when the ink must be replaced.

The ^JUS command must be used to save the settings to the non-volatile memory in the printer.

An example of the command transmission is shown below. It is sent via USB or Ethernet from the computer.

```
^XA
^S(CNA,I,1
^JUS
^XZ
```

Paper out signal (output) mode setting

[Format]

^S(CNA,P,c

[Parameter] c

Description	Definition range
c = Mode setting	D/E/0/1/2

[Function]

This sets the paper out signal mode setting.

Value for parameter c	Description
D/0	Turns the paper out signal (pin 25) OFF (not output).
1	Sets the paper out signal (pin 25) as follows: Normal: High, When there is no paper: Low.
E/2	Sets the paper out signal (pin 25) as follows: Normal: Low, When there is no paper: High.

[Initial value]

0

[Examples of command transmissions]

The paper out signal is set to the mode that is high in the normal status, and low when there is no paper.

The ^JUS command must be used to save the settings to the non-volatile memory in the printer.

An example of the command transmission is shown below. It is sent via USB or Ethernet from the computer.

```
^XA
^S(CNA,P,1
^JUS
^XZ
```

Mode setting for pause signal (input)

[Format]

^S(CNI,P,c

[Parameter] c

Description	Definition range
c = Mode setting	0/1

[Function]

Configure the mode settings for the pause signal.

Value for parameter c	Description
0	Ignore the pause signal (pin 12).
1	Set the pause signal (pin 12) to the following mode: Switch to the pause state when a Low signal is input for 30 msec or longer.

[Initial value]

0

[Examples of command transmissions]

Set the pause signal to "Switch to the pause state when a Low signal is input for 30 msec or longer".

The ^JUS command must be used to save the settings to the non-volatile memory in the printer.

An example of the command transmission is shown below. It is sent via USB or Ethernet from the computer.

```
^XA
^S(CNI,P,1
^JUS
^XZ
```

Mode setting for head cleaning signal (input)

[Format]

^S(CNI,C,c

[Parameter] c

Description	Definition range
c = Mode setting	0/1

[Function]

Configure the mode settings for the head cleaning signal.

Value for parameter c	Description
0	Ignore the head cleaning signal (pin 15).
1	Set the head cleaning signal (pin 15) to the following mode: Clean the head when a Low signal is input for 30 msec or longer.

[Initial value]

0

[Examples of command transmissions]

Set the head cleaning signal to "Clean the head when a Low signal is input for 30 msec or longer".

The ^JUS command must be used to save the settings to the non-volatile memory in the printer.

An example of the command transmission is shown below. It is sent via USB or Ethernet from the computer.

```
^XA
^S(CNI,C,1
^JUS
^XZ
```

Mode setting for clogged nozzle check signal (input)

[Format]

^S(CNI,D,c

[Parameter] c

Description	Definition range
c = Mode setting	0/1

[Function]

Configure the mode setting for the clogged nozzle check signal.

Value for parameter c	Description
0	Ignore the clogged nozzle check signal (pin 14).
1	Set the clogged nozzle check signal (pin 14) to the following mode: Check the nozzles when a Low signal is input for 30 msec or longer.

[Initial value]

0

[Examples of command transmissions]

Set the clogged nozzle signal to "Check the nozzles when a Low signal is input for 30 msec or longer".

The ^JUS command must be used to save the settings to the non-volatile memory in the printer.

An example of the command transmission is shown below. It is sent via USB or Ethernet from the computer.

```
^XA
^S(CNI,D,1
^JUS
^XZ
```

Mode setting for feed signal (input)

[Format]

`^S(CNI,F,c`

[Parameter] `c`

Description	Definition range
<code>c = Mode setting</code>	0/3

[Function]

Configure the mode settings for the feed signal.

Value for parameter <code>c</code>	Description
0	Ignore the feed signal (pin 11).
3	Set the feed signal (pin 11) to the following mode: Feed the label as long as a Low signal is input.

[Initial value]

0

[Examples of command transmissions]

Set the feed signal to "Feed the label as long as a Low signal is input".

The `^JUS` command must be used to save the settings to the non-volatile memory in the printer.

An example of the command transmission is shown below. It is sent via USB or Ethernet from the computer.

`^XA`

`^S(CNI,F,3`

`^JUS`

`^XZ`

Mode setting for start print signal (input)

[Format]

^S(CNI,S,c

[Parameter] c

Description	Definition range
c = Mode setting	0/1/3

[Function]

Configure the mode settings for the start print signal.

Value for parameter c	Description
0	Ignore the start print signal (pin 10). (Normal print mode in which the printer receives and prints data, without using the start print signal input to the external I/O.)
1	Set the start print signal (pin 10) to the following mode: Print labels when a Low signal is input for 30 msec or longer.
3	Set the start print signal (pin 10) to the following mode: Print labels as long as a Low signal is input.

[Initial value]

0

[Examples of command transmissions]

Set the start print signal to "Print labels when a Low signal is input for 30 msec or longer".

The ^JUS command must be used to save the settings to the non-volatile memory in the printer.

An example of the command transmission is shown below. It is sent via USB or Ethernet from the computer.

```
^XA
^S(CNI,S,1
^JUS
^XZ
```

Mode setting for re-print signal (input)

[Format]

^S(CNI,R,c

[Parameter] c

Description	Definition range
c = Mode setting	0/1

[Function]

Configure the mode settings for the re-print signal.

Value for parameter c	Description
0	Ignore the re-print signal (pin 13).
1	Set the re-print signal (pin 13) to the following mode: Reprint the previously printed label when a Low signal is input for 30 msec or longer.

[Initial value]

0

[Examples of command transmissions]

Set the re-print signal to "Reprint labels when a Low signal is input for 30 msec or longer".

The ^JUS command must be used to save the settings to the non-volatile memory in the printer.

An example of the command transmission is shown below. It is sent via USB or Ethernet from the computer.

```
^XA
^S(CNI,R,1
^JUS
^XZ
```

Acquisition Commands for Setting Values

This section describes the commands for acquiring setting values of the printer.

Acquisition commands for mode setting values for end print signal (output)

[Format]

~H(CNA,B

[Parameter] None

[Function]

Acquire the mode setting values for the end print signal.

Return value after executing this command	Description
D/0	End print signal OFF (End print signal not output)
1	End print signal (pin 18) set to Normal: High, When feeding paper: Low
E/2	End print signal (pin 18) set to Normal: Low, When feeding paper: High
3	End print signal (pin 18) set to Normal: High, When continuous printing ends and the printer stops at the predetermined position: Low for 20 msec.
N/4	End print signal (pin 18) set to Normal: Low, When continuous printing ends and the printer stops at the predetermined position: High for 20 msec.

Acquisition commands for mode setting values for data ready signal (output)

[Format]

~H(CNA,A

[Parameter] None

[Function]

Acquire the mode setting values for the print data preparation complete (print data deployed) signal.

Return value after executing this command	Description
D/0	Data ready signal (pin 23) OFF (not output).
1	Data ready signal (pin 23) set to Normal: High, When print data preparation is complete: Low
E/2	Data ready signal (pin 23) set to Normal: Low, When print data preparation is complete: High

Acquisition commands for mode setting values for clogged nozzle detected signal (output)

[Format]

~H(CNA,D

[Parameter] None

[Function]

Acquire the mode setting values for the clogged nozzle detected signal.

Return value after executing this command	Description
D/0	Clogged nozzle detected signal (pin 24) OFF (not output)
1	Clogged nozzle detected signal (pin 24) set to Normal: High, When nozzle clogged: Low
E/2	Clogged nozzle detected signal (pin 24) set to Normal: Low, When nozzle clogged: High

Acquisition commands for mode setting values for head maintenance signal (output)

[Format]

~H(CNA,M

[Parameter] None

[Function]

Acquire the mode setting values for the head maintenance signal.

Return value after executing this command	Description
D/0	Head maintenance signal (pin 21) OFF (not output)
1	Head maintenance signal (pin 21) set to Normal: High, When head maintenance is in progress: Low
E/2	Head maintenance signal (pin 21) set to Normal: Low, When head maintenance is in progress: High

Acquisition commands for mode setting values for printer ready signal (output)

[Format]

~H(CNA,O

[Parameter] None

[Function]

Acquire the mode setting values for the printer ready signal.

Return value after executing this command	Description
D/0	Printer ready signal (pin 19) OFF (not output)
1	Printer ready signal (pin 19) set to Normal: High, When printer is ready: Low
E/2	Printer ready signal (pin 19) set to Normal: Low, When printer is ready: High

Acquisition commands for mode setting values for warning signal (output)

[Format]

~H(CNA,W

[Parameter] None

[Function]

Acquire the mode setting values for the warning signal.

Return value after executing this command	Description
D/0	Warning signal (pin 16) OFF (not output)
1	Warning signal (pin 16) set to Normal: High, When a warning occurs: Low
E/2	Warning signal (pin 16) set to Normal: Low, When a warning occurs: High

Acquisition commands for mode setting values for error & pause signal (output)

[Format]

~H(CNA,E)

[Parameter] None

[Function]

Acquire the mode setting values for the error & pause signal.

Return value after executing this command	Description
D/0	Error & pause signal (pin 17) OFF (not output)
1	Error & pause signal (pin 17) set to Normal: High, When an error occurs: Low
E/2	Error & pause signal (pin 17) set to Normal: Low, When an error occurs: High
3	Set the error & pause signal (pin 17) as follows: Normal: High, When an error occurs or the printer is paused: Low.
N/4	Set the error & pause signal (pin 17) as follows: Normal: Low, When an error occurs or the printer is paused: High.

Acquisition of mode setting value for ink low signal (input)

[Format]

~H(CNA,J)

[Parameter] None

[Function]

This acquires the mode setting value for the ink low signal.

Return value after executing this command	Description
0	Mode in which the ink low signal (pin 8) is OFF (not output)
1	Mode in which the ink low signal (pin 8) is as follows: Normal: High, When there is little ink remaining: Low
2	Mode in which the ink low signal (pin 8) is as follows: Normal: Low, When there is little ink remaining: High

Acquisition of mode setting value for ink cartridge exchange signal (input)

[Format]

~H(CNA,I

[Parameter] None

[Function]

This acquires the mode setting value for the ink cartridge exchange signal.

Return value after executing this command	Description
0	Mode in which the ink cartridge exchange signal (pin 22) is OFF (not output)
1	Mode in which the ink cartridge exchange signal (pin 22) is as follows: Normal: High, When ink must be replaced: Low
2	Mode in which the ink cartridge exchange signal (pin 22) is as follows: Normal: Low, When ink must be replaced: High

Acquisition command of mode setting value for paper out signal (input)

[Format]

~H(CNA,P

[Parameter] None

[Function]

This acquires the mode setting value for the paper out signal.

Return value after executing this command	Description
0	Mode in which the paper out signal (pin 25) is OFF (not output)
1	Mode in which the paper out signal (pin 25) is as follows: Normal: High, When there is no paper: Low
2	Mode in which the paper out signal (pin 25) is as follows: Normal: Low, When there is no paper: High

Acquisition commands for mode setting values for pause signal (input)

[Format]

~H(CNI,P)

[Parameter] None

[Function]

Acquire the mode setting values for the pause signal.

Return value after executing this command	Description
0	Pause signal (pin 12) ignored
1	Pause signal (pin 12) set to switch to the pause state when a Low signal is input for 30 msec or longer

Acquisition commands for mode setting values for head cleaning signal (input)

[Format]

~H(CNI,C)

[Parameter] None

[Function]

Acquire the mode setting values for the head cleaning signal.

Return value after executing this command	Description
0	Head cleaning signal (pin 15) ignored
1	Head cleaning signal (pin 15) set to clean the head when a Low signal is input for 30 msec or longer

Acquisition commands for mode setting values for clogged nozzle check signal (input)

[Format]

~H(CNI,D)

[Parameter] None

[Function]

Acquire the mode setting values for the clogged nozzle check signal.

Return value after executing this command	Description
0	Clogged nozzle check signal (pin 14) ignored
1	Clogged nozzle check signal (pin 14) set to check the nozzles when a Low signal is input for 30 msec or longer.

Acquisition commands for mode setting values for feed signal (input)

[Format]

~H(CNI,F)

[Parameter] None

[Function]

Acquire the mode setting values for the feed signal.

Return value after executing this command	Description
0	Feed signal (pin 11) ignored
3	Feed signal (pin 11) set to feed the label when a Low signal is input for 30 msec or longer

Acquisition commands for mode setting values for start print signal (input)

[Format]

~H(CNI,S)

[Parameter] None

[Function]

Acquire the mode setting values for the start print signal.

Return value after executing this command	Description
0	Start print signal (pin 10) ignored
1	Start print signal (pin 10) set to print labels when a Low signal is input for 30 msec or longer
3	Start print signal (pin 10) set to print labels as long as a Low signal is input

Acquisition commands for mode setting values for re-print signal (input)

[Format]

~H(CNI,R)

[Parameter] None

[Function]

Acquire the mode setting values for the re-print signal.

Return value after executing this command	Description
0	Re-print signal (pin 13) ignored
1	Re-print signal (pin 13) set to reprint the previously printed label when a Low signal is input for 30 msec or longer

Printer Statuses and Signals

This section describes the printer statuses, and the relationships between the printer status and the signal.

Pin	Signal		Signal status and meaning		Printer status							
			Enable	Disable	Printer not connected	Idling	Mechanical sequence running	Ink sequence running	Errors	Pause	Warnings	
16	WARNING		Warning	No warning	-	-	-	-	-		Warning	
17	ERROR & PAUSE	Mode 1 or 2	Error	No error	No error	No error	No error	No error	No error	Error	No error	No error
		Mode 3 or 4	Error or pause	No error and no pause	No error and no pause	No error and no pause	No error and no pause	No error and no pause	No error and no pause	Error	Pause	No error and no pause
18	END PRINT *		Paper feeding	Otherwise	-	Otherwise	Paper feeding	-	-		-	
19	PRINTER READY		Printer ready	Printer not ready	Printer not ready	Printer ready	Printer not ready	Printer not ready	Printer not ready		-	
21	HEAD MAINTENANCE		In maintenance	Not in maintenance	Not in maintenance	Not in maintenance	Not in maintenance	In maintenance	-		-	
23	DATA READY		Data ready	Not ready	-	-	-	-	-		-	
24	CLOGGED NOZZLE DETECTED		Detected	Not detected	-	-	-	-	-		-	

* When Mode 1 or 2 is set

Timing

This section describes the timing charts for the printer operations and signals.

Basic Timing for Label Printing

The basic timing for label printing is as follows.

Signal	Printer status							Signal status
	Idling/ waiting for data	Receiving data	Deploying data	Waiting for printing to start	Backfeed	Printing	Idling/ waiting for data	
PRINTER READY				High	High	High	High	Printer ready Printer not ready
DATA READY		High	High	High	High	High	High	Data ready Not ready
START PRINT				High	High	High	High	
END PRINT				High	High	High	High	Paper feeding Otherwise

The pin 18 end print signal indicates that Mode 1 is set (= the printer feeds paper when Low).

Basic Timing for Pausing

The basic timing for pausing is as follows.

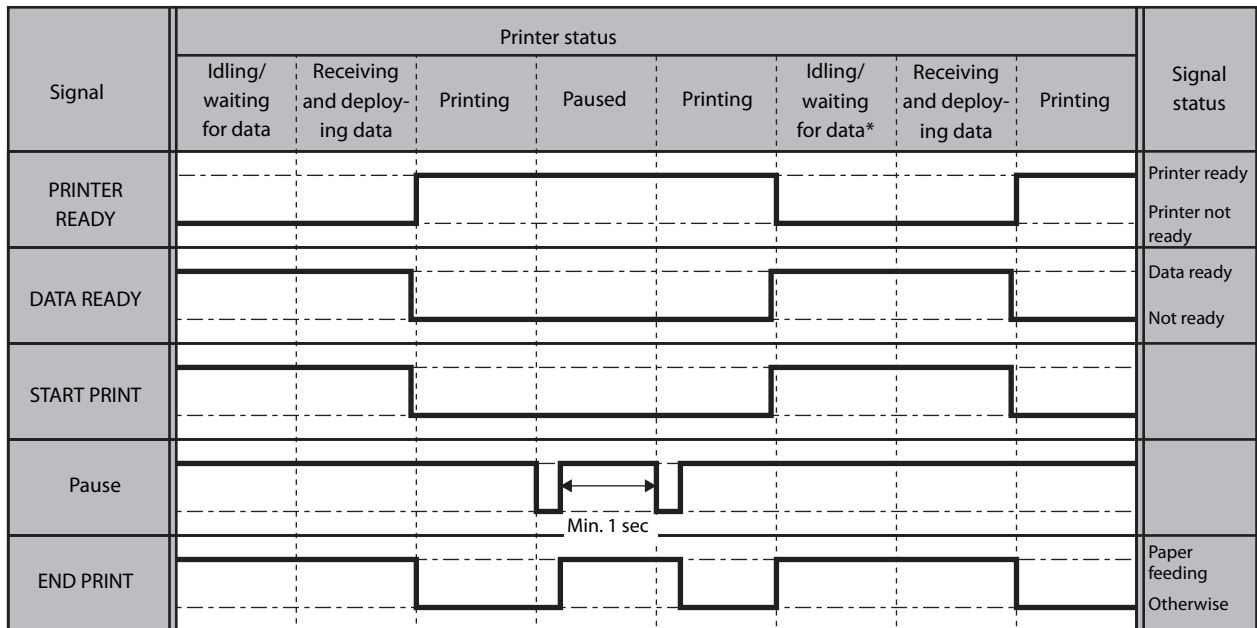

* Once 1 second has elapsed to wait for data, the head is capped. When the head is capped, it takes about 2 seconds to start printing after the start print signal is given for the next print job.

The pin 10 start print signal is indicated when level mode is set, and the pin 18 end print signal is indicated when Mode 1 (= the printer feeds paper during Low) is set.

When transitioning from the Print state to the Pause state, or from the Pause state to the Print state, the pause signal must have an interval of 1 second or more.

Basic Timing for Label Feeding

The timing specifications for when the end print signal (pin 18) is set to Mode 1 or 2 (= signal is asserted when the printer feeds paper) are shown below.

After the label is printed, it is moved to the cutting/specified position and remains there. After the next start print signal is issued, the printer starts printing after the backfeed operation.

Note that backfeed is not included in the paper feed status. (The pin 18 end print signal is not asserted during backfeed.)

When the end print signal is set to Mode 1 (= the printer feeds paper during Low)

Signal	Printer status								Signal status
	Idling/ waiting for data	Receiving and deploy- ing data	Backfeed* ¹	Printing	Move to cut- ting/speci- fied position* ²	Idling/ waiting for data	Receiving and deploy- ing data	Printing	
PRINTER READY									Printer ready Printer not ready
DATA READY									Data ready Not ready
START PRINT									
END PRINT									Paper feeding Otherwise

*1 After the start print signal is issued, printing starts after the backfeed operation.

*2 Even if the label is peeled off, no backfeed operation is performed.

Basic Timing for Nozzle Check and Head Cleaning

The results of the previous nozzle check are applied to the clogged nozzle detected signal.

Nozzle checks are not only executed by the clogged nozzle check signal. They can also be executed automatically in the printer settings.

For this reason, by reading the clogged nozzle detected signal (pin 24) after executing the missing dot check signal, the status of the printer can be detected.

In addition, please check the head maintenance signal (pin 21) to make sure that head maintenance is not in progress, before transmitting the nozzle check instruction.

The head maintenance signal (pin 21) is asserted during a nozzle check or head cleaning.

The steps from nozzle check through head cleaning are described below.

- 1** Check the head maintenance signal to make sure that head maintenance (= nozzle check or head cleaning) is not in progress, and check the error & pause signal to make sure that an error has not occurred.
- 2** Transmit the clogged nozzle check to perform a nozzle check.
- 3** Check the head maintenance signal to make sure that head maintenance is not in progress, and then check the clogged nozzle detected signal to check for clogged nozzles.
Once 3 seconds or more have elapsed after the clogged nozzle check signal is issued, check the clogged nozzle detected signal.
- 4** If a clogged nozzle is discovered in step 3, transmit the head cleaning (pin 15) as necessary to perform head cleaning.



NOTE

If it is unclear whether a nozzle is clogged, such as when a nozzle status unclear warning is issued, the correct value may not be obtained.

Signal	Printer status								Signal status
	Idling/ waiting for data	Checking nozzles	Confirming nozzle check results	Head cleaning	Checking nozzles	Confirming nozzle check results	Receiving and deploying data	Printing	
PRINTER READY									Printer ready Printer not ready
DATA READY									Data ready Not ready
ERROR & PAUSE									Error No error
START PRINT									Not finished Finished
HEAD MAINTENANCE									In maintenance Not in maintenance
CLOGGED NOZZLE CHECK									
CLOGGED NOZZLE DETECTED									Detected Not detected
HEAD CLEANING									

External I/F Signal Operation Mode Settings

This section describes the items that can be set on the printer's operation panel or in the PC utility (Printer Setting).

The items that can be set from the printer's operation panel differ depending on the firmware version of the printer.

End Print Signal Mode Settings

The settings are as follows.

Setting value (mode)	Description
Disable	Turn the end print signal OFF. (End print signal not output)
Mode 1	Set the end print signal as follows: Normal: High, When feeding paper: Low.
Mode 2	Set the end print signal as follows: Normal: Low, When feeding paper: High.
Mode 3	Set the end print signal as follows: Normal: High, When continuous printing ends and the printer stops at the predetermined position: Low for 20 msec.
Mode 4	Set the end print signal as follows: Normal: Low, When continuous printing ends and the printer stops at the predetermined position: High for 20 msec.

Data Ready Signal Mode Settings

The settings are as follows.

Setting value (mode)	Description
Disable	Turn the data ready signal OFF. (Data ready signal not output)
Mode 1	Set the data ready signal as follows: Normal: High, When data is ready: Low.
Mode 2	Set the data ready signal as follows: Normal: Low, When data is ready: High.

Clogged Nozzle detected Signal Mode Settings

The settings are as follows.

Setting value (mode)	Description
Disable	Turn the clogged nozzle detected signal OFF. (Clogged nozzle detected signal not output)
Mode 1	Set the clogged nozzle detected signal as follows: Normal: High, When a clogged nozzle is detected: Low.
Mode 2	Set the clogged nozzle detected signal as follows: Normal: Low, When a clogged nozzle is detected: High.

Head Maintenance Signal Mode Settings

The settings are as follows.

Setting value (mode)	Description
Disable	Turn the head maintenance signal OFF. (Head maintenance signal not output)
Mode 1	Set the head maintenance signal as follows: Normal: High, During head maintenance: Low.
Mode 2	Set the head maintenance signal as follows: Normal: Low, During head maintenance: High.

Printer Ready Signal Mode Settings

The settings are as follows.

Setting value (mode)	Description
Disable	Turn the printer ready signal OFF. (Printer ready signal not output)
Mode 1	Set the printer ready signal as follows: Normal: High, When the printer is ready: Low.
Mode 2	Set the printer ready signal as follows: Normal: Low, When the printer is ready: High.

Warning Signal Mode Settings

The settings are as follows.

Setting value (mode)	Description
Disable	Turn the warning signal OFF. (Warning signal not output)
Mode 1	Set the warning signal as follows: Normal: High, When a warning occurs: Low.
Mode 2	Set the warning signal as follows: Normal: Low, When a warning occurs: High.

Error & Pause Signal Mode Settings

The settings are as follows.

Setting value (mode)	Description
Disable	Turn the error & pause signal OFF. (Error & pause signal not output)
Mode 1	Set the error & pause signal as follows: Normal: High, When an error occurs: Low.
Mode 2	Set the error & pause signal as follows: Normal: Low, When an error occurs: High.
Mode 3	Error & pause signal set to Normal: High, When an error occurs or the printer is paused: Low.
Mode 4	Error & pause signal set to Normal: Low, When an error occurs or the printer is paused: High.

Ink Low Signal Mode Settings

The settings are as follows.

Setting value (mode)	Description
Disable	Turn the ink low signal OFF. (Ink low signal not output)
Mode 1	Set the ink low signal as follows: Normal: High, When the ink is low: Low.
Mode 2	Set the ink low signal as follows: Normal: Low, When the ink is low: High.

Ink Cartridge Exchange Signal Mode Settings

The settings are as follows.

Setting value (mode)	Description
Disable	Turn the ink cartridge exchange signal OFF. (Ink cartridge exchange signal not output)
Mode 1	Set the ink cartridge exchange signal as follows: Normal: High, When an ink cartridge needs to be exchanged: Low.
Mode 2	Set the ink cartridge exchange signal as follows: Normal: Low, When an ink cartridge needs to be exchanged: High.

Paper Out Signal Mode Settings

The settings are as follows.

Setting value (mode)	Description
Disable	Turn the paper out signal OFF. (Paper out signal not output)
Mode 1	Set the paper out signal as follows: Normal: High, When the paper is out: Low.
Mode 2	Set the paper out signal as follows: Normal: Low, When the paper is out: High.

Mode Setting for Pause Signal

Details are as follows.

Setting value (mode)	Description
Disable	Ignore the pause signal.
Enable	Set the pause signal to the following mode: Switch the Pause state when a low pulse signal is input for 30 msec or longer.

Mode Setting for Head Cleaning Signal

Details are as follows.

Setting value (mode)	Description
Disable	Ignore the head cleaning signal.
Enable	Set the head cleaning signal to the following mode: Perform head cleaning when a low pulse signal is input for 30 msec or longer.

Mode Setting for Clogged Nozzle Check Signal

Details are as follows.

Setting value (mode)	Description
Disable	Ignore the clogged nozzle check signal.
Enable	Set the clogged nozzle check signal to the following mode: Perform a clogged nozzle check when a low pulse signal is input for 30 msec or longer.

Mode Setting for Feed Signal

Details are as follows.

Setting value (mode)	Description
Disable	Ignore the feed signal.
Enable	Set the feed signal to the following mode: Feed paper when a low level signal is input for 30 msec or longer.

Mode Setting for Start Print Signal

The settings are as follows.

Setting value (mode)	Description
Disable	Set the start print signal to the following mode: Ignore it even if the start print signal is input. (Normal print mode in which the printer receives and prints data, without using the start print signal input to the external I/O.)
Pulse mode	Set the start print signal to the following mode: Print labels when a Low signal is input for 30 msec or longer.
Level mode	Set the start print signal to the following mode: Print labels as long as a Low signal is input.



Mode Setting for Re-print Signal

Details are as follows.



Setting value (mode)	Description
Disable	Ignore the re-print signal.
Enable	Set the re-print signal to the following mode: Reprint the previously printed label when a Low signal is input for 30 msec or longer.

Appendix

Cautions for Setting Jumpers

 WARNING	<ul style="list-style-type: none"> • To avoid the risk of electric shocks, if disassembling or assembling this product, first remove the power supply cord and all cables from this product. • To prevent the possibility of electrical shock, do not perform maintenance, repair, or inspection during a thunderstorm. • If you want to use a compressed air product, such as an air duster, for cleaning during repair and maintenance, you must never use products containing flammable gas.
 CAUTION	<ul style="list-style-type: none"> • Parts on the circuit board may become hot during operation. Therefore, wait approximately 10 minutes after turning the power off before touching them. • Wear a grounded wrist band when handling the internal circuit board to prevent damage from static electricity. • Be careful not to subject the circuit board to shock or vibration, because this may damage it. • Do not touch the circuit board or cable terminals with your hands to prevent contamination that may result in a malfunction. • Do not use an alcohol, benzine, thinner, trichloroethylene, or ketone-based solvent to clean the parts. This type of solvent may damage the plastic and rubber parts. • As failures may be caused if liquid enters the interior of this product, do not place food or drinks on top of the case. • Wipe off any dirt with a dry or slightly moist cloth. Be sure to remove the power cord from the outlet at this time.

Switching the I/O Power (VCC_EX) and SG

 WARNING	<ul style="list-style-type: none"> • To avoid the risk of electric shocks, if disassembling or assembling this product, first remove the power supply cord and all cables from this product. • To prevent the possibility of electrical shock, do not perform maintenance, repair, or inspection during a thunderstorm. • If you want to use a compressed air product, such as an air duster, for cleaning during repair and maintenance, you must never use products containing flammable gas.
 CAUTION	<ul style="list-style-type: none"> • Parts on the circuit board may become hot during operation. Therefore, wait approximately 10 minutes after turning the power off before touching them. • Wear a grounded wrist band when handling the internal circuit board to prevent damage from static electricity. • Hold the exterior of the board. • Be careful not to subject the circuit board to shock or vibration, because this may damage it. • Do not touch the circuit board or cable terminals with your hands to prevent contamination that may result in a malfunction. • Do not use an alcohol, benzene, thinner, trichloroethylene, or ketone-based solvent to clean the parts. This type of solvent may damage the plastic and rubber parts. • As failures may be caused if liquid enters the interior of this product, do not place food or drinks on top of the case. • Wipe off any dirt with a dry or slightly moist cloth. Be sure to remove the power cord from the outlet at this time.

The I/O power (VCC_EX) and SG are switched as follows.

- 1 Turn off the power supply of this product and remove the power supply plug from the outlet.**
- 2 Press and hold the  (power) button for about 5 seconds to discharge all electricity.**
- 3 Remove the screws (x 7) used to affix the back cover.**



- 4 Remove the back cover.**
Pull the top of the back cover out towards you by 2 cm and then lift the whole cover up to remove it.



While the back cover is open, be absolutely sure not to touch parts inside this product other than those specified in the manual. Doing so could cause failures.

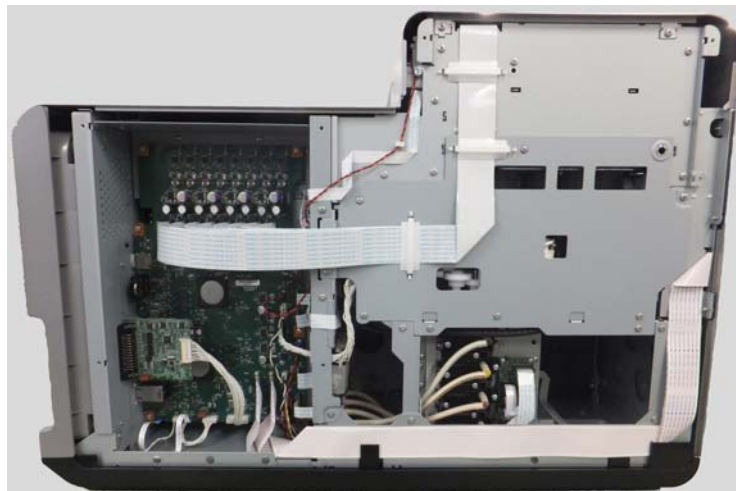

5 Perform jumper settings. Pull out the connector jumper pin and insert it into the number to be set.

Press with your fingers on the right side of the interface board to affix it while pulling and inserting the jumper pin.

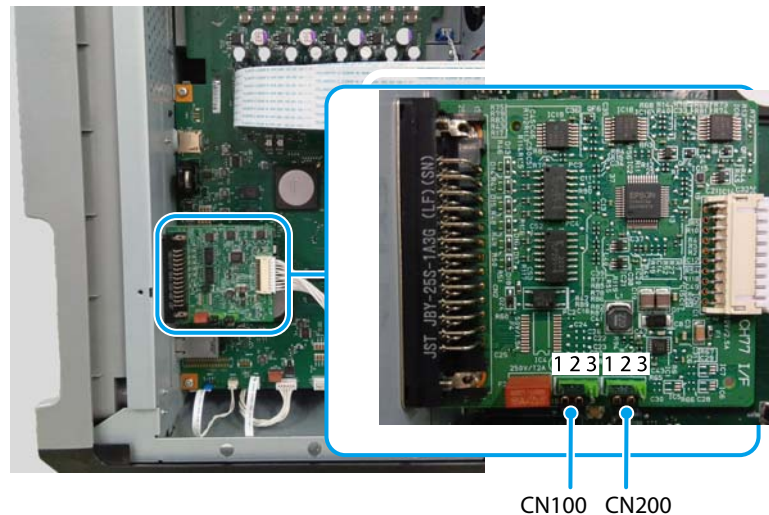

IMPORTANT

- When shorting pins 1 and 2 on CN100, DO NOT short pins 2 and 3 on CN200.
- When shorting pins 2 and 3 on CN100, DO NOT short pins 1 and 2 on CN200.

State	CN100 JP setting	CN200 JP setting
I/O Power/SG not separated (Initial setting)	1-2 pin shorted	1-2 pin shorted
I/O Power/SG separated	2-3 pin shorted	2-3 pin shorted

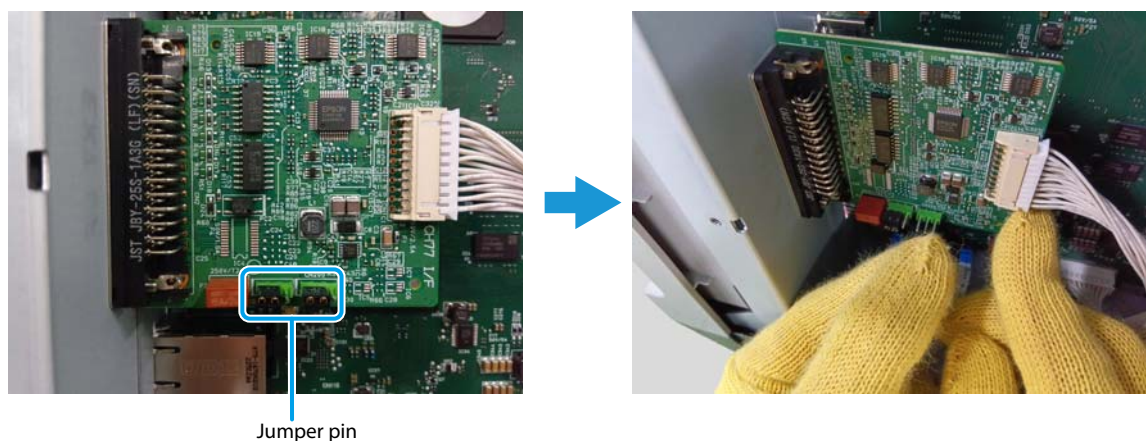

Jumper pin

Once jumper settings are performed, install the covers using the following procedure.

6 Install the back cover and affix it using the screws (x 7).

FAQ

This section provides the answers to questions related to system development.

Questions	Answer
What is the feed control method for the backfeed operation?	Speed control is used to feed paper for the backfeed operation. Tension control is not used.
What is the speed of the backfeed operation?	300 mm/sec (12 ips)
What is the length of the backfeed operation?	The backfeed operation, from the specified stop position (at maximum position adjustment) to the print start position, is approximately 250 mm. With the manual backfeed button, it is approximately 500 mm. It does not depend on the length of the label.
Backing paper winding specifications: How are tension and the backfeed operation handled?	Since paper jams and skewing can occur, the tension for winding the backing paper is set low, to 1 N or less. The backfeed operation draws the backing paper into the printer, so allow some room by using a buffer or dancer roll.
Is there a control method that is not affected by the head capping time, in order to improve the printing speed?	After printing ends, the head will be capped if the waiting for data time is 1 second (initial value) or longer. In that case, it will take longer for printing to start than if the head were not capped. For continuous printing, throughput can be improved by transmitting the data for multiple print jobs in advance, and using the start print signal to keep the issue timing within 1 second so that printing can be performed continuously without capping the head. Please contact us for information about changing the initial value.
Can electromagnetic relays and similar devices be driven directly?	Solid state relays (SSR), electromagnetic relays, and similar devices can be driven directly only when used under the following conditions. <ul style="list-style-type: none"> • The sink current must not exceed 50 mA. • Make sure that the printer I/O power (VCC_EX) and external device I/O power are the same voltage. • Use a device equipped with a surge protection circuit. • The total sink current must not exceed 180 mA when all of the following conditions are satisfied. <ul style="list-style-type: none"> * When I/O power (VCC_EX) and SG are not separated * When the I/O power (VCC_EX) output from pin 9 is used for the external device I/O power. * When using multiple output signals. <p>If controlling by use of the printer side I/O power supply (when I/O power (VCC_EX) and SG are not separated): page 17 If controlling by use of the external device I/O power supply (when I/O power (VCC_EX) and SG are separated): page 18</p>
Can the external device I/O power supply be used at 24 V?	When setting the jumper pin settings to "I/O power (VCC_EX)/SG separated", a 24 V external device I/O power supply can be used. In this case, the input range of the external device I/O power supply is 5 to 28 V. Check the "Figure of Jumper Settings and I/O Power (VCC_EX) and Ground Connections" and set the jumper pin settings to "I/O power (VCC_EX)/SG separated" before connecting to the external device I/O power supply. (page 16)