

CW-C8000 Series

Technical Reference Guide

Product Overview

Describes product features.

Setup

Describes the initial tasks required, such as product installation.

Handling

Describes how to handle the product.

Cleaning the Printer

Describes how to clean the product.

Troubleshooting

Describes how to deal with product problems.

Information for Application Development

Describes how to control the printer and necessary information when you develop applications.

Appendix

Describes specifications of the product.

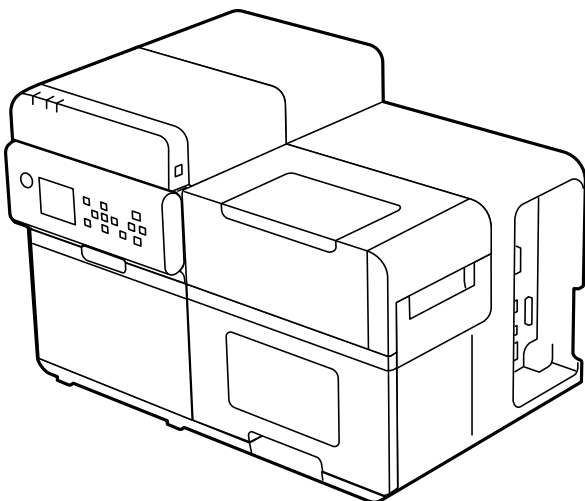

Cautions

- All rights reserved. No part of this publication may be reproduced, stored in a retrieval system, or transmitted in any form or by any means, electronic, mechanical, photocopying, recording, or otherwise, without the prior written permission of Seiko Epson Corporation.
- The content of this manual is subject to change without notice. Please contact us for the latest information.
- While every precaution has been taken in the preparation of this manual, Seiko Epson Corporation assumes no responsibility for errors or omissions.
- Neither is any liability assumed for damages resulting from the use of the information contained herein.
- Neither Seiko Epson Corporation nor its affiliates shall be liable to the purchaser of this product or third parties for damages, losses, costs, or expenses incurred by purchaser or third parties as a result of: accident, misuse, or abuse of this product or unauthorized modifications, repairs, or alterations to this product, or (excluding the U.S.) failure to strictly comply with Seiko Epson Corporation's operating and maintenance instructions.
- Seiko Epson Corporation shall not be liable for any damages or problems arising from the use of any options or any consumable products other than those designated as Genuine Epson Products or Epson Approved Products by Seiko Epson Corporation.

Trademarks

Microsoft, Windows are trademarks of the Microsoft group of companies.

The Bluetooth® word mark and logos are registered trademarks owned by Bluetooth SIG, Inc. and any use of such marks by Seiko Epson Corporation is under license.

Apple, Mac, mac OS, OS X, and ColorSync are trademarks of Apple Inc., registered in the U.S. and other countries.

Zebra Technologies Corporation and ZPL II are the registered trademarks or trademarks of Zebra Technologies Corporation.

Pentium® is a trademark of Intel Corporation in the U.S. and/or other countries.

Adobe, the Adobe logo, Acrobat, Photoshop, PostScript and Reader are either registered trademarks or trademarks of Adobe in the United States and/or other countries.

IOS is a trademark or registered trademark of Cisco in the U.S. and other countries and is used under license.

Android is a trademark of Google LLC.

QR Code is a registered trademark of DENSO WAVE INCORPORATED in Japan and other countries.

BarTender® is registered trademark of Seagull Scientific, Inc. in the United States and other countries.

CODESOFT is registered trademarks or trademarks of TEKLYNX International.

YouTube is a trademark of Google LLC.

All other trademarks are the property of their respective owners and used for identification purpose only.

©Seiko Epson Corporation 2024

Before Use

This chapter describes information you should know before using the product.

Manuals for This Product

Paper manual

Start Here



Guides you through basic setup steps from unpacking to loading paper.

Manual viewable with PC

User's Guide



Describes details about the functions and operating procedures of the product, maintenance information, and troubleshooting. Please visit the URL below.

<https://epson.sn>

Manual viewable with PC

CW-C8000 Series Technical Reference Guide (This manual)



Provides information necessary for installing the product, performing daily tasks, and developing a system using the product.

Download this document from the following URL.

<https://epson.sn>

Manual viewable with PC

Online Video Manual



The videos explain the printer setup procedure in an easy-to-understand manner. Click on the URL below to view the videos.

https://support.epson.net/p_doc/95e/

The contents of videos are subject to change without notice.

Downloading the Latest Version

The latest versions of the printer driver, utilities, and manuals can be downloaded from the following URLs.

For customers in North America, go to the following web site:

<https://www.epson.com/support/>

For customers in other countries and regions, go to the following web site:

<https://epson.sn>

Viewing the Online Video Manual

The video manuals are available on YouTube. Click on the URL below to view the videos.

https://support.epson.net/p_doc/95e/

If subtitles are not displayed during video playback, click on the subtitle icon shown below.

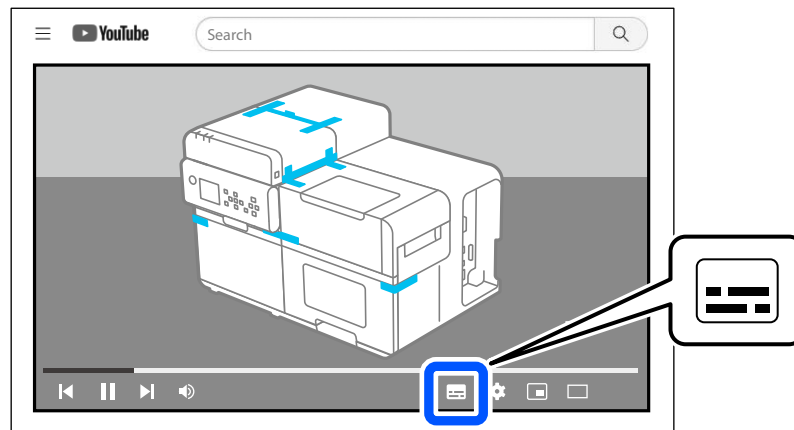



Symbols Used in This Guide





The following symbols are used in this guide to indicate important information.

Symbols for Safety

The symbols shown below are used in this manual in order to ensure safety and proper use of this product and to prevent danger to you and other persons, and property damage. Be sure that you completely understand their meanings before reading this manual.

 WARNING	Handling the product improperly by ignoring this symbol can lead to death or serious injury.
 CAUTION	Handling the product improperly by ignoring this symbol can lead to injury and property damage.

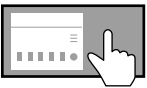
Symbols for General Information

 IMPORTANT	Indicates information with which you must comply when using the product. Mishandling due to ignoring this information may cause the product to fail or malfunction.
	Indicates supplementary explanations and information you should know.
	Indicates a reference page containing related information.
	Indicates that the operation procedure can be viewed on the operation panel. From the home screen, go to [? (Help)] – [How To...] to view the operating instructions.
	Indicates that the video manual is available. Scan the QR code to view the video.

Safety Precautions

To ensure safe use of the product, be sure to read this manual and the other instruction manuals supplied with the product before use. Store this manual in a safe place so that you can resolve any unclear points regarding the product at any time.

Cautions on Installation



- Do not block the air vents of the product.  ["Right Side \(Connectors\)" on page 23](#)
Blocking the air vents may cause heat to build up inside, which could result in a fire.
- Do not cover the product with a cloth or install it in a poorly-ventilated location. Furthermore, ensure there is the installation space specified in the manual.



- Do not install/store the product in an unstable location or in a location subject to vibration from other devices. The product may fall or collapse, causing breakage and possible injury.
- Do not install the product in a location exposed to oily smoke or dust, or in a humid location. Doing so may cause electric shock or fire.
- When lifting the product, perform the work with the correct posture. Lifting the product with an inappropriate posture may cause injury.
- This product is heavy and should not be carried alone. When unpacking or moving the product, two or more persons should carry it. See ["Product Specifications" on page 368](#) for the weight of the product.
- When lifting the product, hold the product by the parts indicated in this manual. Lifting the product by holding other parts of it may cause the product to fall or pinch your fingers when lowering it, which may result in injury.

Cautions on Handling



WARNING

- Do not use the product in a location with volatile substances such as alcohol or paint thinner present, or near fire. Doing so may cause electric shock or fire.
- Shut down the product immediately if it produces smoke, a strange odor, or unusual noise. If you go on using the product, it may result in electric shock or fire. If an abnormality occurs, immediately turn off the power and remove the plug from the outlet, and then contact qualified service personnel for advice.
- Shut down the product immediately if a foreign object or water or other liquid gets inside the product. If you go on using the product, it may result in electric shock or fire. Immediately turn off the power and remove the plug from the outlet, and then contact qualified service personnel for advice.
- Do not disassemble the areas other than those mentioned in this manual.
- Never attempt to repair the product yourself as doing so is dangerous.
- Do not use the product in a location where inflammable gas, explosive gas, etc. is present in the atmosphere. Furthermore, do not use aerosol sprayers containing flammable gas inside or around the product. Doing so may cause fire.
- Do not connect cables in ways other than those mentioned in this manual. Doing so may cause fire. It may also damage the other connected devices.
- Do not touch the areas inside the product other than those mentioned in this manual. Doing so may cause electric shock or burns.
- Do not insert metal or flammable materials, or allow them to fall into the product. Doing so may cause electric shock or fire.
- If the screen of the printer is damaged, handle the liquid crystal inside it very carefully. Should any of the following situations arise, take emergency measures.
 - * If the liquid gets on your skin, wipe it off, flush with water, and rinse thoroughly with soap.
 - * If the liquid gets into your eyes, rinse them with clean water for at least 15 minutes and then consult your doctor.
 - * If the liquid gets into your mouth, consult your doctor right away.



CAUTION

- Do not allow anyone to stand or place heavy objects on top of the product. In particular, be careful in the case of a household with children. The product may fall or collapse, causing breakage and possible injury.
- Install the cables and optional products in the proper direction according to the proper procedures. If they are installed improperly, it may result in fire or injury. Follow the instructions in this manual to install them properly.
- Before moving the product, shut down and unplug the product, and make sure that all the cables are disconnected. Failure to do so may damage a cable, causing electric shock or fire.
- Do not subject the product to vibration or shock while the power is on. Doing so may cause printing malfunction.
- Do not store or transport the product while it is tilted, standing, or upside down. Doing so may cause the ink to leak.
- Do not carry the product with its internal parts pulled out. There is a risk of injury due to falling of those parts.
- When pulling out the internal parts of the product, do so on a flat surface. There is a risk of injury due to falling of those parts.



IMPORTANT

If this product is used in a place where silicon-based gases including siloxane (silicon adhesive, silicon oil, silicon powder, etc.) or malignant gases (nitric acid, hydrogen sulfide, ammonia, chlorine, etc.) are present in the air, contact failure may occur in mechanical contacts such as mechanical switch or DC motor in a short time due to adhesion or oxidation of the insulation film.

Cautions on Power Supply



- Do not use the product with any power supply or voltage other than the ones specified.
- Do not allow dust or other foreign material to adhere to the power plug. Doing so may cause electric shock or fire.
- Insert the power plug securely all the way into the outlet. Otherwise electric shock or fire may occur.
- Do not use a power cord other than that supplied with the product. In addition, do not use the supplied power cord with another device. Doing so may cause electric shock or fire.
- Do not use a damaged power cord. Doing so may cause electric shock or fire. Contact qualified service personnel for advice if the power cord is damaged. Furthermore, observe the following points so as not to damage the power cord.
 - * Do not modify the power cord.
 - * Do not place heavy objects on the power cord.
 - * Do not forcibly bend, twist, or pull the power cord.
 - * Do not lay the power cord near a heating appliance.
- Do not insert or remove the power plug with a wet hand. Doing so may cause electric shock.
- Do not connect the power cord to a power strip which provides electricity to multiple devices. Otherwise electric shock or fire may occur.
- Regularly disconnect the power plug from the outlet and clean the base of the prongs and between the prongs. Leaving the power plug connected to the outlet for a long period of time may cause dust to accumulate on the base of the power plug prongs, resulting in a short and fire.
- Hold the plug and do not pull the cord when disconnecting the power plug from the outlet. Pulling the cord may damage the cord or deform the plug, causing electric shock or fire.
- Do not unplug or plug in this product with the power on. Otherwise electric shock or fire may occur.



To ensure safety, unplug the product before leaving it unused for an extended period.

Cautions on Ink Packs



CAUTION

- If ink gets on your skin or in your eyes or mouth, take the following measures.
 - * If ink gets on your skin, wash it thoroughly with soap and water.
 - * If ink gets into your eyes, immediately flush them with water. If no action is taken, the eyes may become bloodshot or mildly irritated. If any abnormality occurs, consult your doctor right away.
 - * If ink gets into your mouth, consult your doctor right away.
- Do not disassemble an ink pack. Doing so may cause ink to get into eyes or onto skin.
- Do not shake an ink pack too hard. The ink may leak from the ink pack if you swing or shake it too hard.
- Keep ink packs out of the reach of children.
- To maintain good print quality, it is recommended that ink packs be used up within one year of installation in the printer.
- Do not touch the IC chip on an ink pack.
- Store the ink packs at room temperature, away from direct sunlight.
- To maintain the quality of the print head, the product is designed to stop operating before it runs out of ink, leaving some ink in the used ink pack. Running costs vary depending on the environment in which the printer is located and how the printer is used.
- Recycled parts may be used in ink packs, but this does not affect quality.
- The ink packs that can be used differ depending on the model number of the product. Use ink packs compatible with the model number of your printer. [↗ "Ink Packs" on page 396](#)
- Shake new ink packs well before installing them. [↗ "How to Replace the Ink Packs" on page 84](#)
- The product uses ink packs equipped with IC chips to manage the amount of ink used and other information so ink packs are usable even if they are removed and reinstalled. However, if an ink pack with not much ink remaining is removed and reinstalled, it may not be usable. Some ink is consumed each time packs are installed because the product automatically checks their reliability.
- When replacing the black ink pack, make sure to replace with a pack of the same type of black ink. The printer does not work if you install a pack of different type of black ink.
- Install ink packs of all colors. Printing is not possible if even only one ink pack is missing.
- To keep the print head in good condition, ink of all colors is consumed not only for printing but also for maintenance operations such as ink pack replacement and head cleaning.
- Do not turn off the power or open the paper cover, top cover, or ink cover while the printer is charging ink (while the  (power) LED is flashing). If the covers are opened, ink will be re-charged when they are closed, and extra ink will be consumed. Also, you may not be able to print properly.
- Even for monochrome printing, all the ink colors are used in an operation designed to maintain the printing and print head quality.
- Do not disassemble or modify an ink pack. Doing so may cause printing malfunction.
- There may be some ink around the ink supply port on a removed ink pack. Take care so that it does not stain the desk or other surface.
- Do not open an ink pack package until you are ready to install the ink pack in the product.
- When the ink cover is opened, make sure that no foreign objects enter the inside of the printer or the ink pack tray. If foreign objects do enter, printing may not be possible. When removing foreign objects, remove them so as not to damage the surrounding parts.
- When ink is charged the first time (right after purchase), ink is consumed for filling the print head nozzles (ink discharge holes) to get ready for printing. Therefore, the number of the sheets that can be printed may be fewer than for packs installed later.
- The print head is automatically capped to prevent ink from drying out. Do not unplug the power plug or turn off the circuit breaker while the product is operating. Doing so may result in the print head not being capped.
- Printing on water-repellent paper such as art paper, which is slow-drying, may cause print stains. Also, if you print on glossy paper, fingerprints may get on the paper or ink may adhere to your fingers when you touch the print surface. Select and use paper that will not cause print stains.



- If the ink pack has been stored in a cold place for a long time, leave it at room temperature for at least 4 hours before use.
- Do not remove the ink packs from the product when storing or transporting the product.

Cautions on the Maintenance Box



- Store in a place out of reach of children. Do not drink any adhered ink.
- Do not disassemble or modify the maintenance box. Doing so may cause ink to get into eyes or onto skin.
- Do not touch the IC chip on the maintenance box.
- If a maintenance box that can still be used has been removed and left detached for a long period of time, do not reuse it.
- Do not peel off the film from the top surface of the maintenance box.
- If ink gets on your skin or in your eyes or mouth, take the following measures.
 - * If ink gets on your skin, wash it thoroughly with soap and water.
 - * If ink gets into your eyes, immediately flush them with water. If no action is taken, the eyes may become bloodshot or mildly irritated. If any abnormality occurs, consult your doctor right away.
 - * If ink gets into your mouth, consult your doctor right away.
- Do not shake a used maintenance box too hard. The ink may leak from the maintenance box if you swing or shake it too hard.
- Avoid storing the maintenance box under high temperatures or in a frozen state.
- Keep it away from direct sunlight.

Caution Label

The labels affixed to the product indicate the following cautions.



**KEEP HANDS
CLEAR**

Be careful not to trap your hands or fingers when opening or closing the paper cover. Failure to observe this precaution could result in injury.

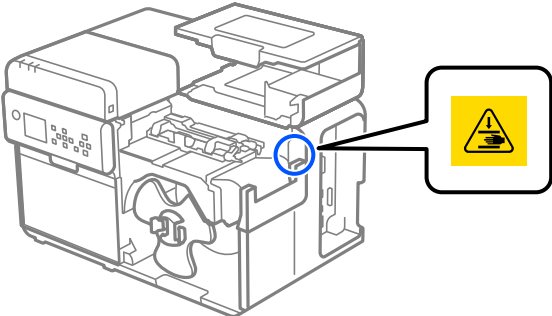

Restriction of Use

When this product is used for applications requiring high reliability/safety such as transportation devices related to aviation, rail, marine, automotive etc.; disaster prevention devices; various safety devices etc.; or functional/precision devices etc., you should use this product only after giving consideration to including fail-safes and redundancies into your design to maintain safety and total system reliability. This product is not intended for use in applications requiring an extremely high level of reliability and safety, such as in aerospace instruments, main communication equipment, nuclear power control equipment, or medical equipment, etc. Please make your own judgment on this product's suitability after a full evaluation.

About This Manual

Aim of the Manual

This manual is intended to provide information required for developing, designing, and installing a system, and for developing and designing printer applications for developers.

Manual Content

This manual consists of the following chapters.

Chapter 1	Product Overview
Chapter 2	Setup
Chapter 3	Handling
Chapter 4	Cleaning the Printer
Chapter 5	Troubleshooting
Chapter 6	Information for Application Development
Appendix	Product Specifications

Screenshots

Unless otherwise noted, Windows 11 and mac OS Ventura screenshots are used in this manual. Depending on the printer model and OS version that you use, the screenshots may differ from actual Windows and Mac screens.

Depending on version of the printer driver and utility you are using, screens shown in this manual may slightly differ from actual screens.

Contents

■ Before Use	3
Manuals for This Product.....	3
Symbols Used in This Guide.....	5
Safety Precautions.....	6
Cautions on Installation.....	6
Cautions on Handling.....	7
Cautions on Power Supply.....	8
Cautions on Ink Packs.....	9
Cautions on the Maintenance Box.....	10
Caution Label.....	11
■ Restriction of Use	12
■ About This Manual	12
Aim of the Manual.....	12
Manual Content.....	12
Screenshots.....	12
■ Contents	13

Product Overview..... **19**

■ About Models of this Product	19
Gloss Black Ink/Matte Black Ink.....	19
Product Firmware and Driver Versions.....	19
■ Part Names and Functions	21
Front.....	21
Left Side.....	22
Right Side (Connectors).....	23
Inside Front.....	24
Inside Paper Path.....	25
Operation Panel.....	26
■ Auto Nozzle Check System	30
Nozzle Check Basic Settings.....	30
Settings for Nozzle Check during Printing.....	31
Complementary Printing (Dot substitution) Function.....	33
■ Periodic Auto Cleaning	34
Setting Time to Start the Periodic Auto Cleaning.....	34
Execution of the Periodic Auto Cleaning.....	34
Examples of the Time Setting to Avoid Interrupting Printing Operation.....	34
■ Reprinting	35
■ Cutting Unfinished Labels	36
When Unfinished Labels Have Not Reached the Cut Position.....	36
When Unfinished Labels Have Already Passed the Cut Position.....	37

■ Checking the Printer Status	38
Checking the Printer Status on the Printer Screen.....	38
Checking the Printer Status by Printing Nozzle Check Patterns	39
Checking the Printer Status by Printing Status Sheet.....	40
Checking Network Connection and Settings	41
<hr/>	
Setup	42
■ Setup Workflow	42
■ Unpacking	43
■ Removing the Protective Materials	44
■ Installing the Printer	45
■ Connecting the Power Cable	46
■ Turning On/Off	47
Turning the Power On	47
Turning the Power Off.....	47
■ Setting Language and Date/Time	48
■ Selecting Black Ink Type	48
■ Installing the Ink Packs and Charging Ink First Time	49
■ Installing the Printer Driver and Connecting to a Computer	50
■ Configuring Network Settings	51
■ Connecting to a Host Device	52
Connecting to Wired LAN.....	52
Connecting to Wireless LAN (Wi-Fi) using a Wireless LAN Router	52
Connecting to Wireless LAN (Wi-Fi) using Wi-Fi Direct.....	59
■ Media Settings	65
■ Loading Paper	66
Loading Roll Paper	67
Loading Fanfold Paper	72
Ejection Angle of Printed Paper	77
Feeding Paper into the Printer Manually.....	78
■ Test Print	79
Self-Test Printing.....	80
■ Removing Paper	81
■ Replacing the Ink Packs	84
Checking Amount of Ink Remaining	84
How to Replace the Ink Packs.....	84
■ Replacing the Maintenance Box	88
Checking the Amount of Empty Space in the Maintenance Box.....	88
How to Replace the Maintenance Box	88

Handling91

■ Printer driver for Windows 91	91
How to Display the Printer Driver Screen91	91
Printer Driver Screen Configuration92	92
Media (Paper) Settings93	93
User-Defined Paper98	98
Paper Source and Paper Detection Settings 103	103
Favorite Settings..... 105	105
Printing Barcodes..... 108	108
Printing 2D Symbols..... 119	119
Printing Barcodes / 2D Symbols on .NET Environment 126	126
User Defined Information 128	128
Exporting/Importing Printer Driver Settings 128	128
Setting EPSON Status Monitor 3..... 133	133
Starting PrinterSetting from the Printer Driver 138	138
Restrictions on Using the Printer Driver..... 139	139
Isolating the Printer Driver..... 140	140
Sharing the Printer Driver on the Server PC to Print 142	142
■ Printer Driver for Mac 165	165
Basic Procedure for Printing..... 165	165
Customizing the Printer Driver..... 173	173
Epson Label Printer Utility..... 175	175
■ Printer Driver for Linux 177	177
Getting the Package (epson-inkjet-printer-cw-c8000)..... 178	178
Installing the Printer Driver 178	178
Installing Input/Output Modules 178	178
Adding the Printer to the CUPS 178	178
Installing Epson Label Printer Utility for Linux 180	180
Starting Epson Label Printer Utility for Linux..... 180	180
Exiting Epson Label Printer Utility for Linux..... 181	181
Uninstalling Printer Driver, Epson Label Printer Utility for Linux 181	181
■ Printing from SAP System 182	182
Methods of Printing from SAP System 182	182
Direct Printing 184	184
Indirect Printing..... 184	184
High Volume Printing 184	184
■ PrinterSetting (Windows) 185	185
How to Start PrinterSetting 186	186
How to Apply Settings 187	187
Media settings..... 188	188
Layout settings..... 189	189
Position adjustment 191	191
Print results adjustment..... 193	193
Store data in the printer..... 194	194
Background image settings 198	198
Print head maintenance 202	202
Printer settings..... 203	203
Adjust Uneven Colors 204	204

Panel settings	207
Operating Time Settings.....	208
Nozzle check settings	209
Advanced settings	210
Initialize printer	218
Printer information	219
Settings save or restore.....	221
Option	222
■ Operation Panel Settings.....	223
■ Restricting Operation of the Operation Panel (Lock Setting function)	237
Checking the Initial Value for the Administrator Password	237
Enabling the [Lock Setting] Function	237
Changing the Administrator Password	238
Resetting the Administrator Password.....	239
■ Web Config	240
■ Epson Device Admin.....	242
■ EPSON Cloud Solution PORT.....	243
How to Register the Printer	243
■ Using Loftware's Loftware Cloud	246
Registering a Printer (Web Config)	246
Registering a Printer (Epson Device Admin)	253
How to Check the Printer Connection Status	261
Troubleshooting	266
■ Spot Color Settings	267
Creating Spot Color Setting File.....	267
Printing using the Spot Color Setting File.....	272
■ Color Correction	273
Relationship Between Driver Settings, Color Correction Methods, and Spot Color Settings.....	273
Color Correction Method Options by Model	274
Using the Printer's Color Correction Engine	276
Using the OS's Color Correction Engine.....	278
Using Application's Color Correction Engine.....	288
■ Printing from the First Label	289
■ Setting Label Size and Paper Layout for Borderless Printing	290
Borderless Printing Concepts.....	290
Label Paper Settings	291
■ Adjusting Head-Media Clearance Height.....	292
■ Adjusting Detectors Sensitivity and Label Detection Thresholds	293
■ Adjusting the Gap Detector	294
Gap Detector Adjustment Examples.....	296
■ Storing the Printer After Ink is Charged	298
Storing the Printer for Long Periods.....	298
Transporting or Storing the Printer at –10°C (14°F) (With Matte Black Ink Installed)	299
For Using the Printer after Long Storage	299

■ For Transporting the Printer	300
--------------------------------------	-----

Cleaning the Printer..... 301

■ Cleaning the Exterior.....	302
■ Cleaning the Auto Cutter.....	302
■ Cleaning the Edge Guides	303
■ Cleaning the Paper Pressure Roller	305
■ Cleaning the Gap Detector (Light Emitting Unit)	307
■ Cleaning the Platen	308
■ Print Head Cleaning.....	309
Printing Nozzle Check Patterns.....	309
Running Print Head Cleaning.....	311

Troubleshooting..... 312

■ A Message Appears on the Operation Panel	312
■ Print Quality Problems	317
■ Cannot Print	321
■ Cannot Print Continuously	324
■ Cannot Feed Paper from Outside the Printer	324
■ Network Connection Check Errors.....	325
Error Code	325
Messages about the network environment	327
■ Unable to Connect to the Network.....	328
Problem with Wireless LAN Network Device(s)	328
The Devices and the Wireless Router are Too Far Apart to Receive Signals	328
Wireless LAN Settings do Not Match with a Replaced New Router	328
Computer or Smart Device and Printer are Connected to Different SSIDs	328
Privacy Separator Function of the Wireless LAN Router is Enabled	328
IP Address has Not been Assigned Correctly	329
Radio Frequency Interference caused by Device Connected to USB 3.0 port.....	329
Problem with the Network Settings of the Computer or Smart Device.....	329
■ A Message Appears on the Computer Screen	330
■ Printing from a Computer is Impossible or Becomes Suddenly Impossible.....	331
Checking Whether the Printer Driver Is Installed	331
Reconnecting the Printer and Computer	331
Checking the [Printers & scanners]	332
Checking the Print Data.....	332
The Printer does Not Turn On	333

■ Print Job is Canceled on PC but “Printing” Message Still Appears on the Printer	334
■ Error Beep Sound Does Not Stop	334
■ Paper Jam	335
Roll Paper is Jammed	335
Fanfold Paper is Jammed	340

***Information for Application Development*..... 345**

■ How to Control the Printer	345
■ Using the Epson Inkjet Label Printer SDK	346
Operating Environment	346
How to Get Software	346
■ Using the iOS SDK/Android SDK/Web Application SDK	347
How to Get Software	347
■ Using the ESC/Label Commands	347
How to Get Software	347
■ Replacing from ZPL II Compatible Monochrome Printer	348
Changing from Two-Step Printing to One-Step Printing	348
Utilizing Templates	365
■ Software and Manuals	366
Software	366
Manual	366

***Appendix*..... 368**

■ Product Specifications	368
Operating Environment	369
Paper Specifications	370
Paper Detection System	390
Electrical Specifications	391
Reliability	392
Environmental Specifications	393
Overall Dimensions	394
■ Consumables Specifications	396
Ink Packs	396
Maintenance Box	397
■ Option	398
Rewinder (TU-RC8000)	398
■ Downloading Printer Driver, Utilities, and Manuals	403
■ Label Print Applications	403
How to Get Software	403

Product Overview

This chapter describes features of the product.

About Models of this Product

Gloss Black Ink/Matte Black Ink

You can select either gloss black (BK) or matte black (MK) for the type of black ink you want to use. The printer prompts you to select it when you turn on the printer for the first time.

**IMPORTANT**

You cannot change the black ink type once you select the black ink type and let the printer charge the ink.

Product Firmware and Driver Versions

Use the product with a combination of latest versions of the product firmware, printer driver, and utility.

How to Check the Printer Firmware Version

You can check the version of your printer firmware by using one of the following methods.

- Printing the status sheet ("[Checking the Printer Status by Printing Status Sheet](#)" on page 40)
- Checking on the operation panel ("[Operation Panel Settings](#)" on page 223)

How to Check the Printer Driver Version

You can check the version in the printer driver screen.

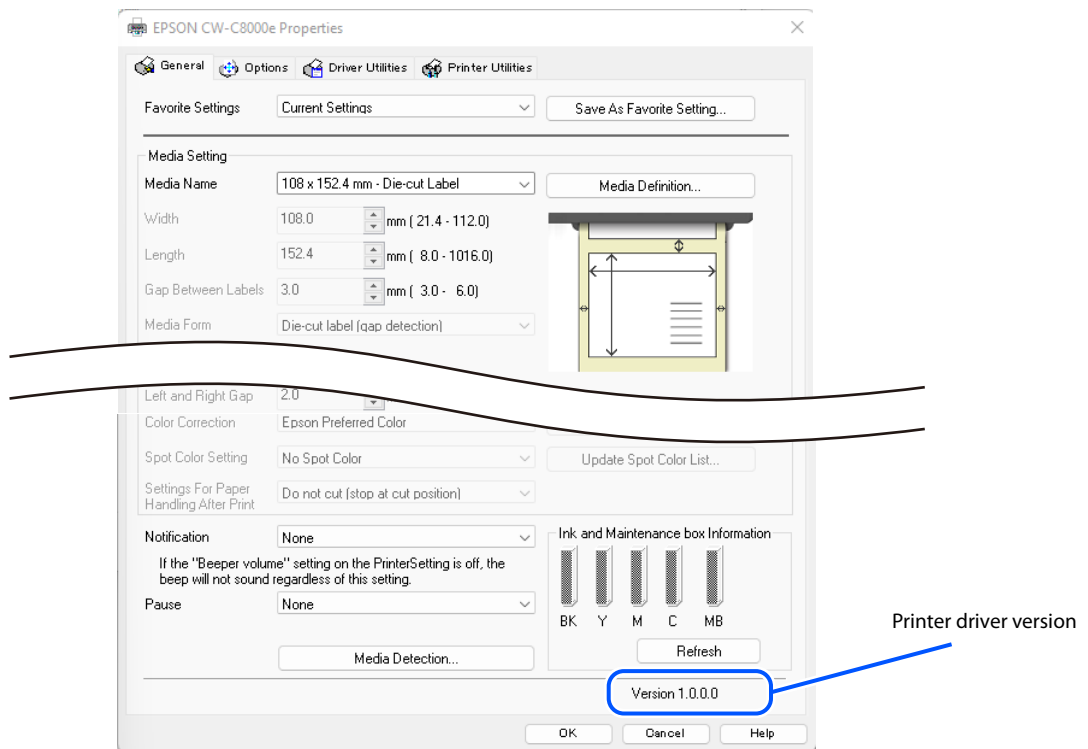

To get the latest version of the printer driver and utility, see "[Downloading Printer Driver, Utilities, and Manuals](#)" on page 403.

Part Names and Functions

This section describes the main operation parts.

Front

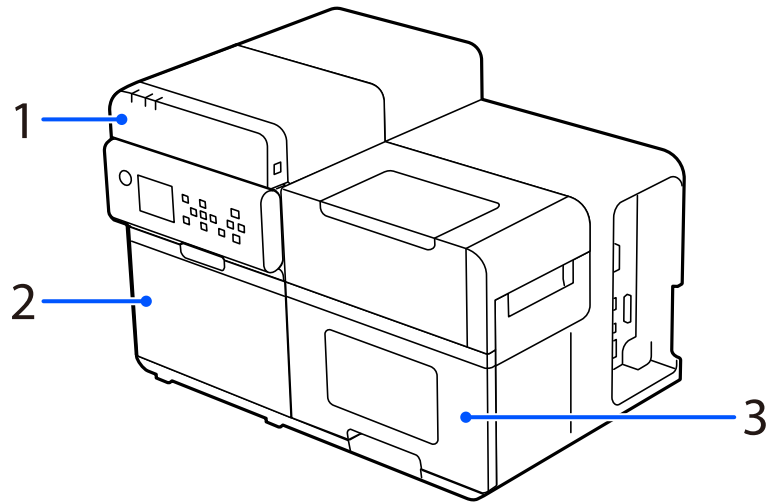

No.	Name	Description
1	Top cover	Open this cover to remove jammed paper or for cleaning.
2	Ink cover	Open this cover to install or replace the ink packs or maintenance box. 🔗 "Replacing the Ink Packs" on page 84 🔗 "Replacing the Maintenance Box" on page 88
3	Paper cover	Open this cover to load or replace paper.

Left Side

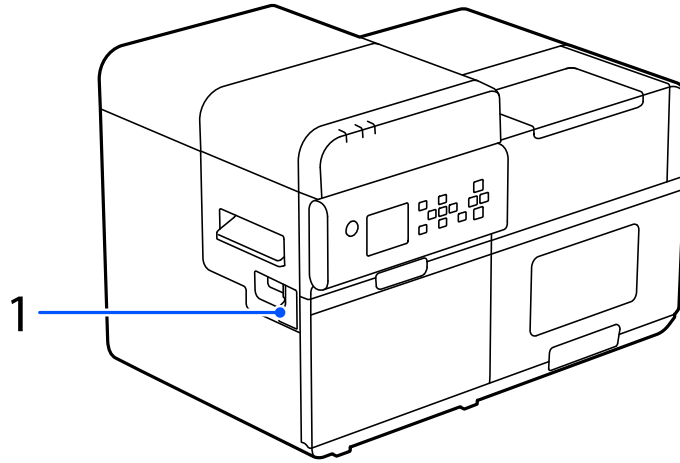

No.	Name	Description
1	Rewinder connection cover	Open this cover to connect the optional rewinder. 🔗 "Rewinder (TU-RC8000)" on page 398

Right Side (Connectors)

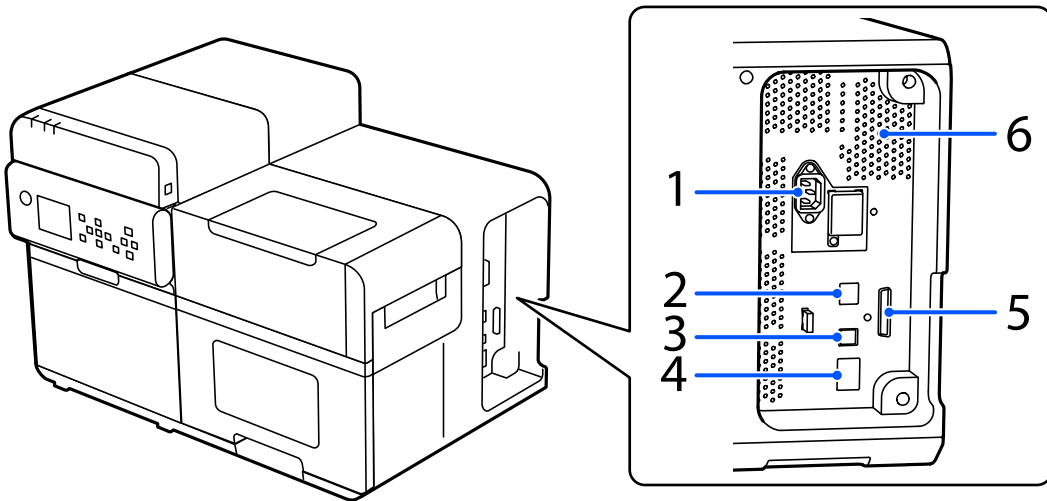

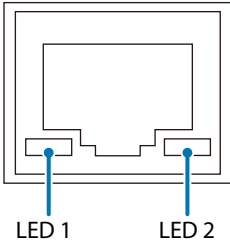
No.	Name	Description																	
1	Power connector	Connect the power cable.																	
2	USB A port (for optional wireless LAN unit only)	Connect the optional wireless LAN unit.																	
3	USB B port	Connect a USB Type B cable.																	
4	LAN port	<p>Connect a LAN cable.</p> <p>LED Status Indication</p>  <table border="1"> <thead> <tr> <th>LED</th> <th>LED status</th> <th>Description</th> </tr> </thead> <tbody> <tr> <td rowspan="3">LED1</td> <td>Lit yellow</td> <td>Connecting at one of the speeds</td> </tr> <tr> <td>Flashing yellow</td> <td>Sending/receiving data</td> </tr> <tr> <td>Off</td> <td>Not connected</td> </tr> <tr> <td rowspan="3">LED2</td> <td>Lit green</td> <td>Connecting using 1000BASE-T</td> </tr> <tr> <td>Lit orange</td> <td>Connecting using 100BASE-TX</td> </tr> <tr> <td>Off</td> <td>Connecting using 10BASE-T, or not connected</td> </tr> </tbody> </table>	LED	LED status	Description	LED1	Lit yellow	Connecting at one of the speeds	Flashing yellow	Sending/receiving data	Off	Not connected	LED2	Lit green	Connecting using 1000BASE-T	Lit orange	Connecting using 100BASE-TX	Off	Connecting using 10BASE-T, or not connected
LED	LED status	Description																	
LED1	Lit yellow	Connecting at one of the speeds																	
	Flashing yellow	Sending/receiving data																	
	Off	Not connected																	
LED2	Lit green	Connecting using 1000BASE-T																	
	Lit orange	Connecting using 100BASE-TX																	
	Off	Connecting using 10BASE-T, or not connected																	
5	EXT.I/F	This port is used only by specific users to control external devices.																	
6	Air vent	Exhausts heat generated in the printer to prevent the temperature inside the printer from rising. Provide a clearance of 10 cm {3.94"} or more from the air vent to ensure ventilation when installing the printer.																	

Inside Front

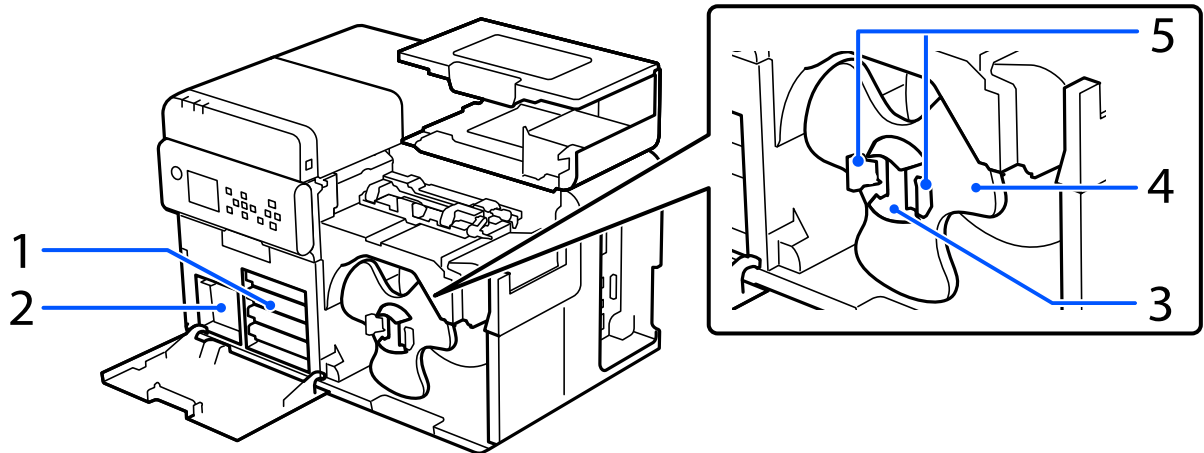

No.	Name	Description
1	Ink pack tray	Load four (4-color) ink packs into each of the four trays. When a message appears indicating that the ink pack(s) needs to be replaced, pull out the corresponding tray to replace the ink pack(s). ☞ "Replacing the Ink Packs" on page 84
2	Maintenance Box	The maintenance box is a container that stores waste ink discharged during head cleaning. When a message appears indicating that the maintenance box needs to be replaced, pull out the maintenance box and replace it with a new one. ☞ "Replacing the Maintenance Box" on page 88
3	Spindle	Load roll paper on this spindle.
4	Roll paper flange	Attach this to the spindle to fix the roll paper loaded on the spindle.
5	Lever	Squeeze the levers to unlock the flange to install/remove it to/from the spindle.

Inside Paper Path

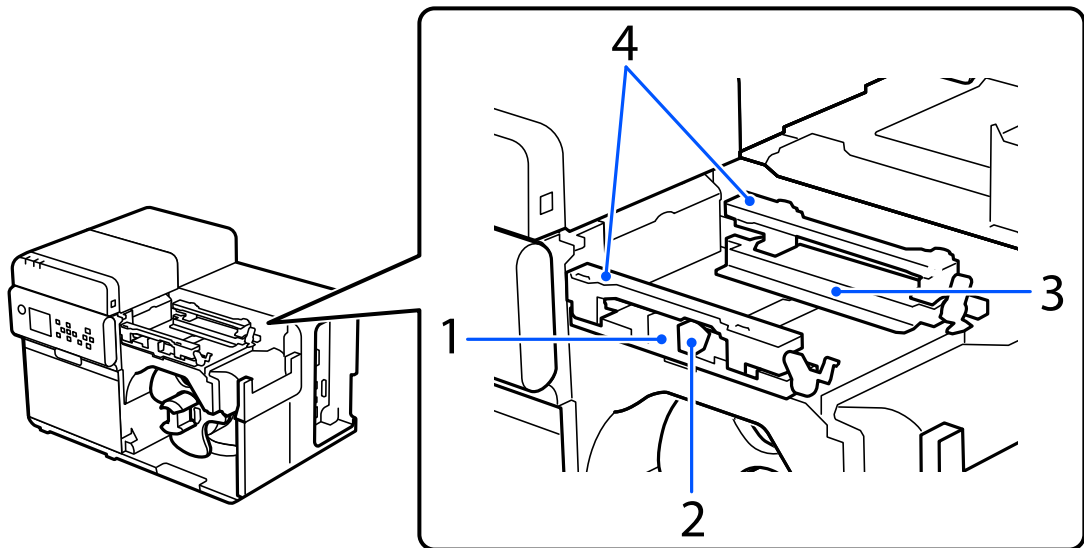

No.	Name	Description
1	Movable edge guide	A guide for feeding paper straight. While pressing the blue lever, slide this guide against the paper, until the white guide plate aligns with the paper edge.
2	Lever (blue)	Press this lever to slide the movable edge guide.
3	Edge guide	A guide for feeding paper straight. Slide paper against this guide so that the paper is fed along the guide.
4	Paper hold	Hold the paper down so that the paper is fed flat.

Operation Panel

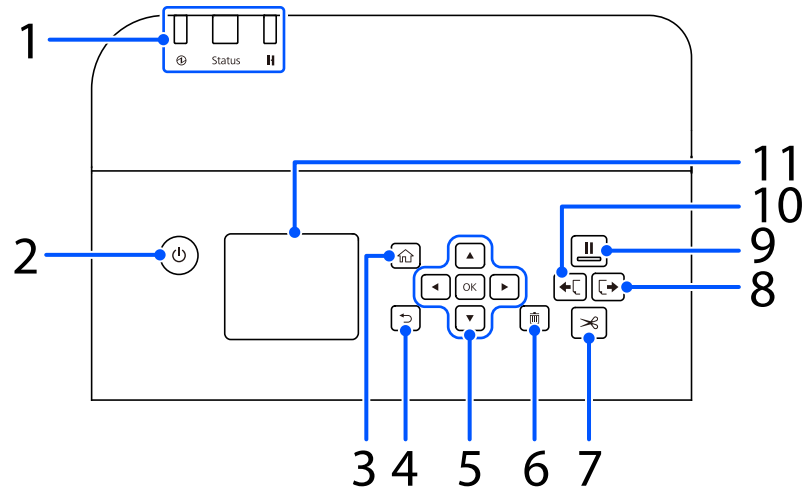

No.	Name	Description
1	LED	<p>The status of the printer can be checked from the flashing of the LEDs.</p> <ul style="list-style-type: none"> ⏻ (Power) LED Stays on while the printer is on. Flashes during printing or charging ink. Status LED Stays on or flashes while an error or problem is occurring. ⏸ (Pause) LED Stays on or flashes while the printer is paused.
2	⏻ (power) button	Turns the printer on or off.
3	🏠 (home) button	Displays the Home screen.
4	↶ (back) button	Use to return to the previous screen.
5	▲◀▼▶ (arrows) buttons and OK button	Use the ▲◀▼▶ buttons to select a menu item, and then press the OK button to activate the selected menu or setting.
6	🗑 (cancel) button	<p>Cancels current print job.</p> <p>Press the 🗑 (cancel) button while the printer is paused, and select [Next label format] or [All label formats] on the [Cancel Selection] screen to cancel printing.</p>
7	✂ (cut) button	Use to cut paper.
8	↶ (back-feed) button	Use this button when replacing paper. Press the ✂ (cut) button to separate the printed paper, then press and hold the ↶ (back-feed) button to feed the paper backward to pull the paper out of the printer.

No.	Name	Description
9	⏸ (pause) button	<ul style="list-style-type: none"> When this button is pressed during printing: Printing is stopped after printing of the current page is finished, and the ⏸ (pause) LED comes on. If the button is pressed again, printing resumes and the ⏸ (pause) LED goes off. When this button is pressed while the printer is in the standby state: The printer pauses and the ⏸ (pause) LED comes on. If the button is pressed again, the printer returns to the standby state and the ⏸ (pause) LED goes off. When this button is pressed while printing is paused due to an error: The printer is released from pause mode and the ⏸ (pause) LED goes off.
10	⏪ (feed) button	<p>When the ⏪ (feed) button is pressed, the paper is fed by the following length. The length varies depending on the form of paper.</p> <ul style="list-style-type: none"> Paper with black marks, Paper with gaps 1 page Others 25.4 mm {1 in.} <p>If the ⏪ (feed) button is held down after the above length of paper is fed, the paper is fed continuously as long as the button is held down.</p>
11	Screen	Status of the printer, menus, and error messages are displayed.



Home Screen

You can check the printer status on the printer screen.

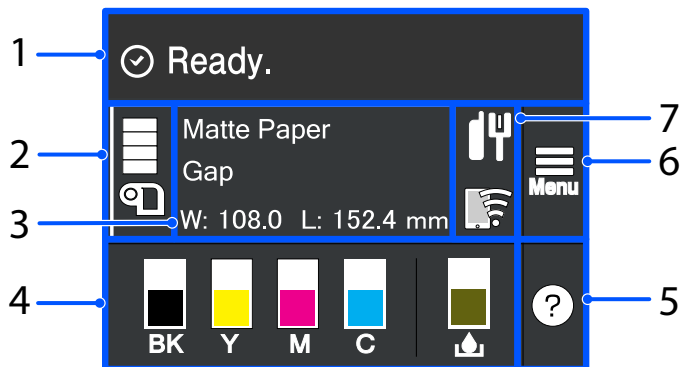
Select a target part of the screen using the ▲◀▶▼ buttons and OK button on the operation panel.



No.	Name	Description
1	Message area	Displays printer status and error messages.
2	Media source/Remaining amount of roll paper	<p>Paper source (roll or fanfold) is indicated.</p> <p>Depending on which paper, roll or fanfold, is used, the paper icon changes. When [Media Source] is set to [External Feed], "EX" appears below the paper icon.</p> <p>When [Media Source] is set to [Internal Roll], you can check the remaining amount of roll paper.</p>

No.	Name	Description
3	Paper information	<p>You can check the paper settings. Select this area to directly access the [Menu] - [Media Settings] menus. Note: You can also make the paper settings using the printer driver. If the settings differ between the operation panel and the printer driver, the settings of the printer driver are applied.</p> <p> "Media (Paper) Settings" on page 93</p>
4	Ink levels/Waste ink level	<p>Shows the approximate ink level in each color ink pack and the approximate amount of free space in the maintenance box. The shorter the bar, the lower the remaining quantity and free space.</p> <ul style="list-style-type: none"> • [!] mark Indicates that it is almost time to replace the ink pack(s) or the maintenance box. • [×] mark Indicates that the ink pack(s) or the maintenance box needs to be replaced. • When matte black ink is used, black ink is indicated as "MK".
5	Help menu	<p>You can see how to deal with problems and basic printer operation procedures.</p> <p> "Operating Instructions Screen" on page 29</p>
6	Settings menu	<p>Displays menus for maintenance, printer operation settings, network settings, etc. It is indicated as [Menu] in this manual.</p>
7	Network icon	<p>By connecting the optional wireless LAN unit (OT-WL06), the printer can communicate via wireless LAN. If these network icons do not appear on the home screen, make sure the wireless LAN unit is connected and restart the printer.</p>

Operating Instructions Screen

You can view the operating instructions on the printer's screen. Use the ▲◀▼▶ buttons and the OK button on the operation panel to switch between the steps. Some operating instructions automatically switch between multiple images.

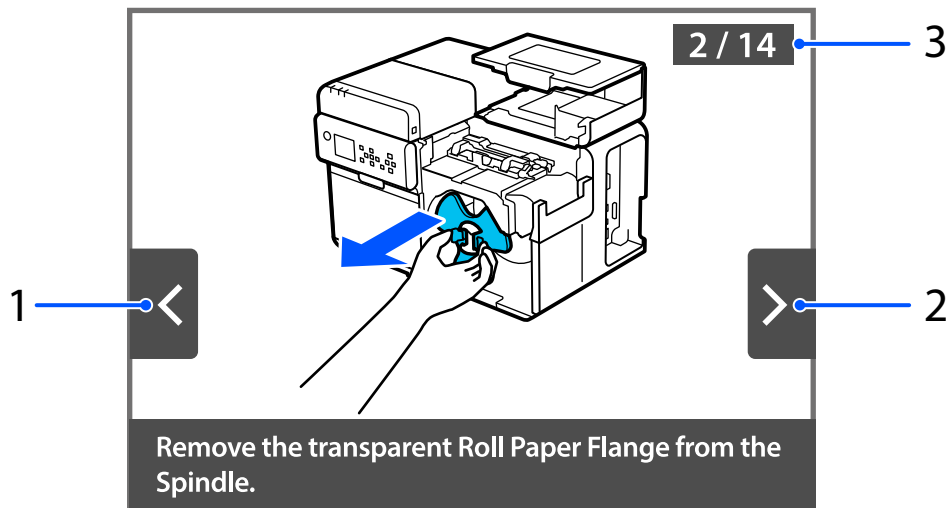

No.	Name	Description
1	Back button	Press the ◀ button on the operation panel to display the previous step.
2	Forward button	Press the ▶ button on the operation panel to display the next step.
3	Step number	The total number of steps is displayed. The number of the currently displayed step is shown in blue.



Auto Nozzle Check System

This printer is equipped with the automatic nozzle check function. The setting can be changed depending on how much deterioration in print quality (missing dots) caused by clogged nozzles can be allowed.

The printer performs the nozzle check at the following timing.

- When the printer is turned on
- When the paper cover is closed after a paper jam
- Just before running a regularly scheduled cleaning
(["Periodic Auto Cleaning" on page 34](#))

If nozzle clogging (missing dots) is not resolved even after head cleaning, complementary printing can be performed using nozzles adjacent to the clogged nozzles. By using these functions, you can prevent sharp decline in the print quality and barcode quality.

 IMPORTANT	<ul style="list-style-type: none"> • This function does not completely prevent nozzle clogging. The printer cannot perfectly detect missing dots and skewed ink drops on printouts. • To prevent misreading of characters that are partially missing due to nozzle clogging, it is recommended to use the printer with its default nozzle check settings. For information about the default settings, see [Maintenance] - [Nozzle check settings] in "Operation Panel Settings" on page 223. • If extremely high reliability is required for printouts, it is recommended to use fonts whose height is 3-dots or more.
	<ul style="list-style-type: none"> • If [Perform Head Cleaning when Clogged Nozzle Detected] is set to [On] or [On(Not During Printing)] and the number of detected clogging nozzles exceeds the set [Threshold of Clogged Nozzles], head cleaning will be performed automatically. After head cleaning, the nozzle check is performed again, and if the check result still exceeds the threshold, head cleaning is run again. Ink is consumed for the head cleaning. • The head cleaning is performed on only those heads and inks with nozzle clogging detected, or on all heads, depending on the nozzle clogging condition. • A small amount of ink is consumed for the auto nozzle check system.

Nozzle Check Basic Settings

The following are basic nozzle check settings.

- Threshold of Clogged Nozzles
- Perform Head Cleaning when Clogged Nozzle Detected

Threshold of Clogged Nozzles (Criteria for Judging Nozzle Clogging)

Specify the allowable number of clogged nozzles to be used for the self nozzle check system. If the number of clogged nozzles exceed the set number, the printer performs the operation set by [Perform Head Cleaning when Clogged Nozzle Detected]. If the number of clogged nozzles is less than the set number, you can select to use the complementary printing (Dot substitution) function. The factory default is "6".

How to Set

Set using the operation panel of the printer, or using PrinterSetting.

See ["Operation Panel Settings" on page 223](#) or ["PrinterSetting \(Windows\)" on page 185](#).

Head Cleaning when Clogged Nozzle Detected

Set whether to run head cleaning automatically when the nozzle check determines that the nozzles are clogged. The factory default is “On” which runs head cleaning.

How to Set

Set using the operation panel of the printer, or using PrinterSetting.

- On
Print head cleaning is automatically run when nozzle clogging is detected.
- On (Not During Printing)
When nozzle clogging is detected during printing, print head cleaning is run automatically after printing.
- Off
Print head cleaning is not run even if nozzle clogging is detected.

See ["Operation Panel Settings" on page 223](#) or ["PrinterSetting \(Windows\)" on page 185](#).

Settings for Nozzle Check during Printing

The following are settings for nozzle check during printing.

- Nozzle Clog Detection
- Detection Interval
- Perform Nozzle Verification when Detected
- Print Action when Detected

Nozzle Clog Detection (Settings for Nozzle Check during Printing)

Select whether to run a nozzle check during printing.

The factory default is [Do not activate].

How to Set

Set using the operation panel of the printer, or using PrinterSetting.

- Perform for each specified number of sheets
A nozzle check is performed every time the number of pages set in [Detection Interval] is reached. [Detection Interval] can be set in the range of 1 to 25,000 pages in single-page increments. The factory default is “500”.
- Do not activate
Nozzle checks are not performed during printing.

See ["Operation Panel Settings" on page 223](#) or ["PrinterSetting \(Windows\)" on page 185](#).



The number of sheets counted in [Detection Interval] is initialized when the set number of sheets is reached and a nozzle check is performed, or when the product is turned off.

Perform Nozzle Verification when Detected

Set whether to use the complementary printing function when nozzle clogging is detected. ("[Complementary Printing \(Dot substitution\) Function](#)" on page 33)

The factory default is "Enable".

How to Set

Set using the operation panel of the printer, or using PrinterSetting.

- **Disable**
Complementary printing is not performed even if nozzle clogging is detected.
- **Enable**
If nozzle clogging is detected, complementary printing is performed using nozzles near the clogged nozzles.
See "[Operation Panel Settings](#)" on page 223 or "[PrinterSetting \(Windows\)](#)" on page 185.

Print Action when Detected

Set whether to continue or stop printing when the number of clogged nozzles set in [Threshold of Clogged Nozzles] is exceeded. When nozzle clogging is detected, the printer will notify you of this on its screen.

The factory default is "Continue Printing".

How to Set

Set using the operation panel of the printer, or using PrinterSetting.

- **Pause Printing**
When the number of clogged nozzles exceeds the set number, the printer notifies you of that status and enters a print standby **||** (pause) state. To resume printing, press the **||** (pause) button.
- **Continue Printing**
When the number of clogged nozzles exceeds the set number, the printer notifies you but continues printing.
See "[Operation Panel Settings](#)" on page 223 or "[PrinterSetting \(Windows\)](#)" on page 185.

Default settings (Initializing nozzle check settings)

You can restore the nozzle check settings to the state at the time of purchase (default value).

How to Set

Set using the operation panel of the printer, or using PrinterSetting.

See "[Operation Panel Settings](#)" on page 223 or "[PrinterSetting \(Windows\)](#)" on page 185.

Complementary Printing (Dot substitution) Function

The complementary printing (Dot substitution) function automatically complements missing dots caused by clogged nozzles with dots generated by nozzles adjacent to the clogged nozzles. The number of nozzles that can be complemented is up to 16 nozzles. However, if the clogged nozzles are located next to each other, the complement function does not work well. If the number of clogged nozzles exceeds 16, complementing 16 nozzles is performed without stopping the printing operation.

You cannot use this function if you have disabled the auto nozzle check function. Enable the “Nozzle check settings” to use this function.



- This function cannot perfectly complement missing dots, so drop in print quality or barcode quality can occur even if this function is used.
- Since the complement is performed according to information of clogged nozzles that has been acquired when starting printing, nozzles that get clogged during printing are not complemented.
- If the paper type is high glossy paper or glossy film, missing dots caused by nozzle clogging may not be fully complemented. Please examine print quality with the paper well before using it.

How to Set

Set using the operation panel of the printer, or using PrinterSetting.

The factory default is “Enable”.

See ["Operation Panel Settings" on page 223](#) or ["PrinterSetting \(Windows\)" on page 185](#).

Periodic Auto Cleaning

To maintain the print head in good condition, the printer may run a cleaning automatically. The cleaning takes 4 to 9 minutes, and printing is disabled during the cleaning. To prevent the cleaning from running when you want to print, set the time to start the periodic auto cleaning.

The cleaning will start at the specified time. However, the cleaning is not run if the printer determines that the print head does not need to be cleaned.

Setting the cleaning start time allows you to clean the print head without interrupting printing operation. The default time is "0:00".

Setting Time to Start the Periodic Auto Cleaning

Set using the operation panel of the printer, or using PrinterSetting.

During the cleaning, printing is disabled. Specify a time when the printer is on but not in use. The time can be set in one-minute increments.

For the setting procedure, see "[Operation Panel Settings](#)" on page 223 or "[PrinterSetting \(Windows\)](#)" on page 185.



- The cleaning takes 4 to 9 minutes.
- If you set a time within less than 10 minutes from the current time, the cleaning is run at the set time 24 hours later.

Execution of the Periodic Auto Cleaning

At the set time, the cleaning is automatically run if the printer is on and it determines that the cleaning is necessary.



- If the printer has been left unused without being powered on for a long time, the cleaning may be run when the printer is turned on.
- In the following cases, the cleaning is not run at the set time. It is run next time the printer is turned on.
 - The printer is not powered on.
 - The ink level is too low to run the cleaning, or some ink pack(s) needs to be replaced.
 - The remaining amount of space in the maintenance box is too low to run the cleaning, or the box needs to be replaced.

Examples of the Time Setting to Avoid Interrupting Printing Operation

The followings are examples of the cleaning start time setting to reduce the likelihood of unintended cleaning during printing.

In the case that the printer is always powered on

Set the time to a time that printing work is not performed, such as midnight.

In the case that the printer is powered on and off every day

- Set the time to a time that the printer is off, such as midnight, to let the printer run the cleaning right after it is powered on.
- If printing work is not performed during lunch break, set the time to a time such as 12:00 in order to let the printer run the cleaning during the lunch break.

Reprinting

Reprinting is carried out when an error other than a fatal error or maintenance error occurs during printing. If unfinished labels are generated when paper has run out, they are automatically cut out.

 ["Cutting Unfinished Labels" on page 36](#)

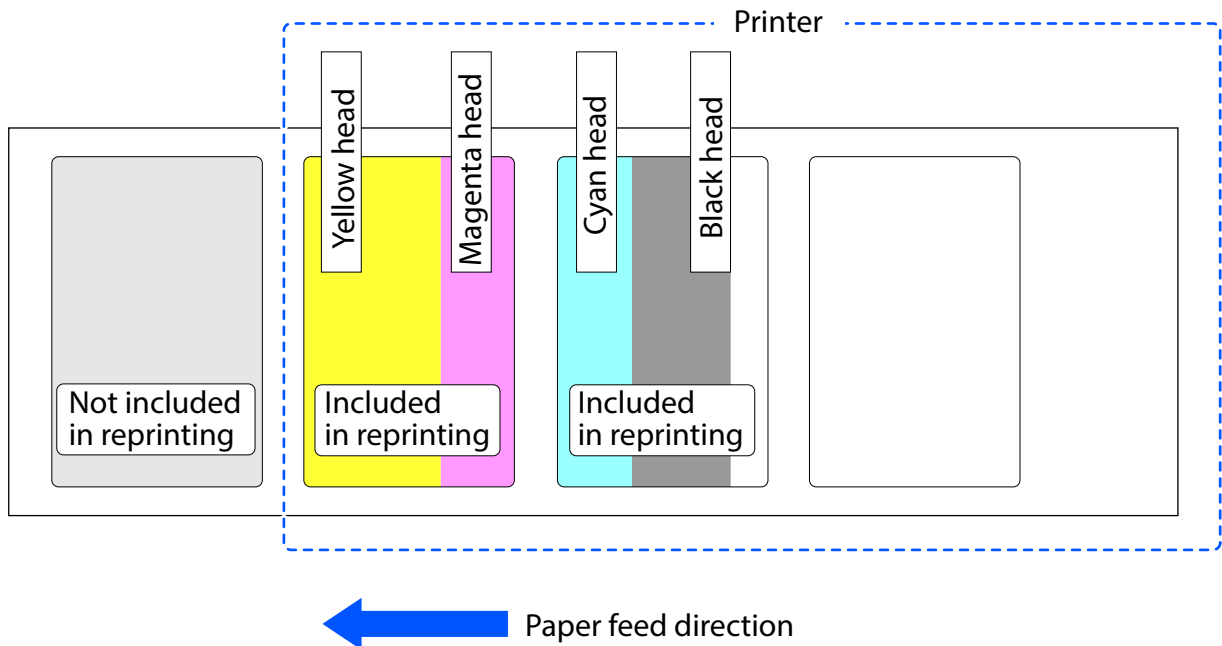

- "During printing" refers to the process from the time the paper is moved to the print start position until the printing operation of the yellow head is completed.
- Because this printer uses a four-color line printing system, several unfinished labels that are halfway through printing may be created depending on the length of the labels used.
- Reprinting is performed on a page-by-page basis.
- Reprinting is not performed if the error that causes reprinting is cleared by canceling the job, resetting, or turning the power on or off.

Cutting Unfinished Labels

Since this printer uses a four-color line printing system, if printing stops in the middle for some reason, it may result in unfinished labels that have only been printed by some of the four color heads.

If printing is interrupted by a no paper error and there are unfinished labels, they are automatically fed forward or backward* by half of the set paper length and cut out. This function can be set on the printer's operation panel or in PrinterSetting.

* There is a limit to the forward/backward feeding length. Depending on the set print speed and paper length, it may not be possible to cut the paper at the position half the set paper length.



- If there are multiple unfinished labels, only the first label is cut out.
- This function does not work when an error other than a no paper error occurs, such as a paper jam error.

The following shows how the printer handles an unfinished label generated at a print speed of 300 mm/s {11.81 in/s} and a paper length of 80 mm {3.15 in.}.

When Unfinished Labels Have Not Reached the Cut Position



When Printing is Paused

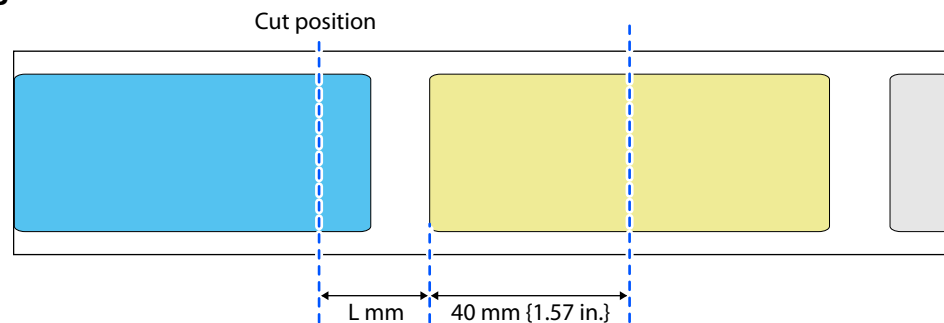

After Feeding the Paper

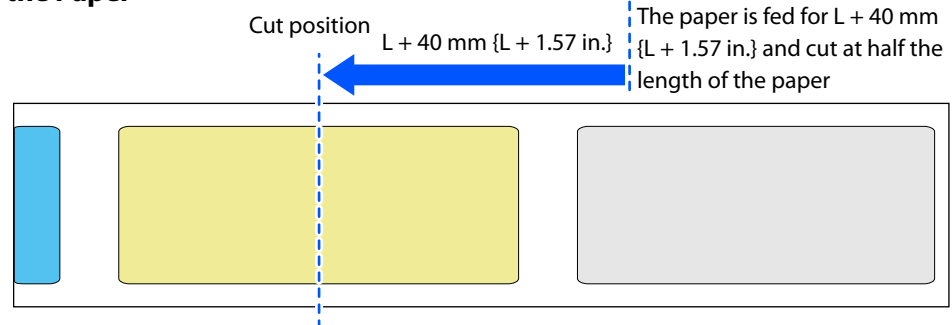

When Unfinished Labels Have Already Passed the Cut Position

← Paper feed direction Printed label Unfinished label Unused label

When Printing is Paused

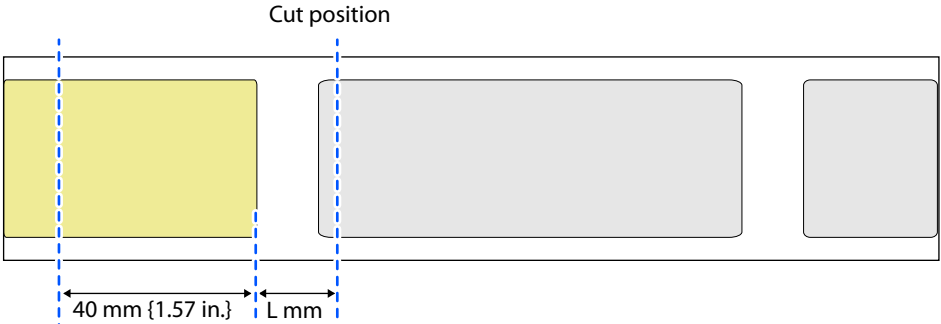

After Feeding the Paper Backward

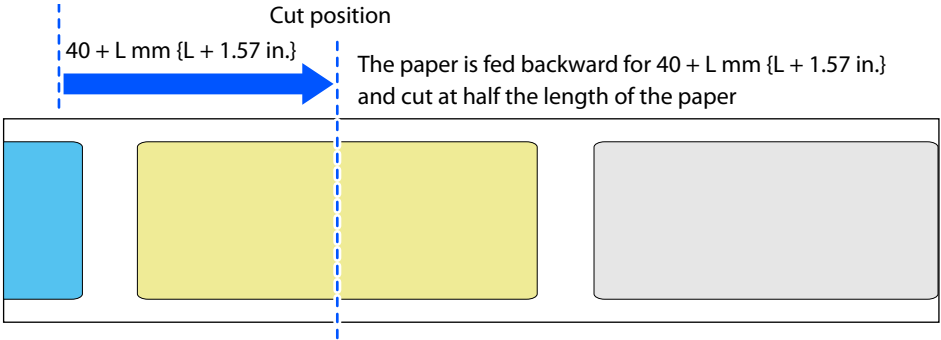

Checking the Printer Status

The status of the printer can be checked from the lighting/flashing of the LEDs, and from the printer screen. You can also check the printer settings by printing a status sheet and check the nozzle status by printing a nozzle check pattern.

["Checking the Printer Status by Printing Status Sheet" on page 40](#)

["Printing Nozzle Check Patterns" on page 309](#)

Checking the Printer Status on the Printer Screen

You can check the printer status on the printer screen.

Select a target part of the screen using the ▲◀▼▶ buttons and OK button on the operation panel.

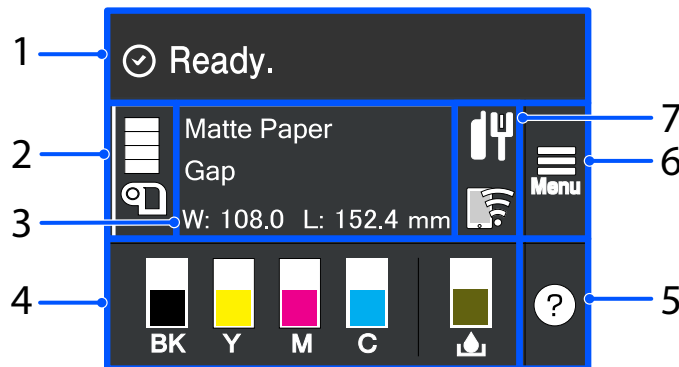

No.	Name	Description
1	Message	A printer status or an error message is displayed.
2	Media source/Remaining amount of roll paper	Paper source (roll or fanfold) is indicated. Depending on which paper, roll or fanfold, is used, the paper icon changes. When [Media Source] is set to [External Feed], "EX" appears below the paper icon. When [Media Source] is set to [Internal Roll], you can check the remaining amount of roll paper.
3	Paper information	You can check the paper settings. Select this area to directly access the [Menu] - [Media Settings] menus. Note: You can also make the paper settings using the printer driver. If the settings differ between the operation panel and the printer driver, the settings of the printer driver are applied. "Media (Paper) Settings" on page 93
4	Ink levels/Waste ink level	Shows the approximate ink level in each color ink pack and the approximate amount of free space in the maintenance box. The shorter the bar, the lower the remaining quantity and free space. <ul style="list-style-type: none"> [!] mark Indicates that it is almost time to replace the ink pack(s) or the maintenance box. [x] mark Indicates that the ink pack(s) or the maintenance box needs to be replaced. Matte black ink is displayed as "MK".

No.	Name	Description
5	Help menu	You can see how to deal with problems and basic printer operation procedures.  "Operating Instructions Screen" on page 29
6	Settings menu	Displays menus for maintenance, printer operation settings, network settings, etc. It is indicated as [Menu] in this manual.
7	Network icon	By connecting the optional wireless LAN unit (OT-WL06), the printer can communicate via wireless LAN. If these network icons do not appear on the home screen, make sure the wireless LAN unit is connected and restart the printer.

Checking the Printer Status by Printing Nozzle Check Patterns

By printing the nozzle check patterns, you can check the print head nozzles for clogging.
To print the check patterns, select the menu as described below.

Using the Operation Panel

[Menu] - [Maintenance] - [Print Head Nozzle Check]

Using the Printer Driver

Click [Nozzle Check] on the [Printer Utilities] window.

Using the Web Config

Select [Print Nozzle Check Pattern] on the [Maintenance] window, and then click [Start].

Checking the Printer Status by Printing Status Sheet

By printing the status sheet, you can check the firmware version and the current printer settings, such as print mode and media detection settings. The following types of status sheets can be printed from the operation panel.

[Menu] - [Printer Status/Print] - [Print Status Sheet]



When printing the status sheets, it is recommended to use paper larger than 101.6 mm {4.00 in.} wide by 152.4 mm {6.00 in.} long.

Status Sheet Example	Status Sheet (Network Settings) Example																																
<pre> <Printer Status Sheet> Sheet Output Time YYYY.MM.DD hh:mm <Basic Information> Model XX-XXXX BK Serial Number XXXXXXXXXX Main Firmware Version XXXXXXX MAC Address XX:XX:XX:XX:XX:XX IP Address Setting Auto/Manual IP Address XXX.XXX.XXX.XXX Subnet Mask XXX.XXX.XXX.XXX Gateway Address XXX.XXX.XXX.XXX Head ID XXXXXXXXXXXXXXXXXXXXXXXXXXXXXXXXXXXX </pre> <hr style="border: 0; border-top: 1px solid black; margin: 10px 0;"/> <table style="width: 100%; border-collapse: collapse;"> <tr><td style="width: 5%;">03</td><td style="width: 15%;">xxxx</td><td style="width: 15%;">yyyy/mm/dd hh:mm</td><td style="width: 15%;">.....</td></tr> <tr><td>04</td><td>xxxx</td><td>yyyy/mm/dd hh:mm</td><td></td></tr> <tr><td>05</td><td>xxxx</td><td>yyyy/mm/dd hh:mm</td><td></td></tr> <tr><td>06</td><td>xxxx</td><td>yyyy/mm/dd hh:mm</td><td></td></tr> <tr><td>07</td><td>xxxx</td><td>yyyy/mm/dd hh:mm</td><td></td></tr> <tr><td>08</td><td>xxxx</td><td>yyyy/mm/dd hh:mm</td><td></td></tr> <tr><td>09</td><td>xxxx</td><td>yyyy/mm/dd hh:mm</td><td></td></tr> <tr><td>10</td><td>xxxx</td><td>yyyy/mm/dd hh:mm</td><td></td></tr> </table>	03	xxxx	yyyy/mm/dd hh:mm	04	xxxx	yyyy/mm/dd hh:mm		05	xxxx	yyyy/mm/dd hh:mm		06	xxxx	yyyy/mm/dd hh:mm		07	xxxx	yyyy/mm/dd hh:mm		08	xxxx	yyyy/mm/dd hh:mm		09	xxxx	yyyy/mm/dd hh:mm		10	xxxx	yyyy/mm/dd hh:mm		<pre> HHH NetWork Status Sheet HHH <General Info> MAC Address xx:xx:xx:xx:xx:xx Firmware xxxxxxxx <Ethernet> Network Status Auto(Disconnected) <TCP/IP IPv4> Obtain IP Address Manual IP Address xxx.xxx.xxx.xxx Subnet Mask xxx.xxx.xxx.xxx Default Gateway xxx.xxx.xxx.xxx HHHHHHHHHHHH 1/1 HHHHHHHHHHHH </pre>
03	xxxx	yyyy/mm/dd hh:mm																														
04	xxxx	yyyy/mm/dd hh:mm																															
05	xxxx	yyyy/mm/dd hh:mm																															
06	xxxx	yyyy/mm/dd hh:mm																															
07	xxxx	yyyy/mm/dd hh:mm																															
08	xxxx	yyyy/mm/dd hh:mm																															
09	xxxx	yyyy/mm/dd hh:mm																															
10	xxxx	yyyy/mm/dd hh:mm																															



- You can also print a list of the fonts and bar codes that are already registered in the printer, or the newly registered images and templates.
- If the Wireless LAN Unit has been connected to the printer, wireless network status and settings are printed on the status sheet.

Checking Network Connection and Settings

You can check the network connection status and settings by printing a network connection check report.



When printing the network connection check report, it is recommended to use paper larger than 101.6 mm {4.00 in.} wide by 152.4 mm {6.00 in.} long.

Network Connection Check Report Example

Check Network Connection	
Check Result	Pass
Network is working correctly.	
If your problems persist, see your documentation for help and networking tips.	
Checked Items	
Ethernet cable Connection Check	Pass
IP Address Check	Pass
Detailed IP Setup Check	Pass
Network Status	
Printer Name	XX-XXXXX
Printer Mode1	XXXXXXXXXX
IP Address	XXX.XXX.XXX.XXX
Subnet Mask	XXX.XXX.XXX.XXX
Default Gateway	XXX.XXX.XXX.XXX
Mac Address	XX:XX:XX:XX:XX:XX

Setup

This chapter describes procedures for installing and setting up the printer that are required before using the printer.

Setup Workflow

The setup workflow is as follows.

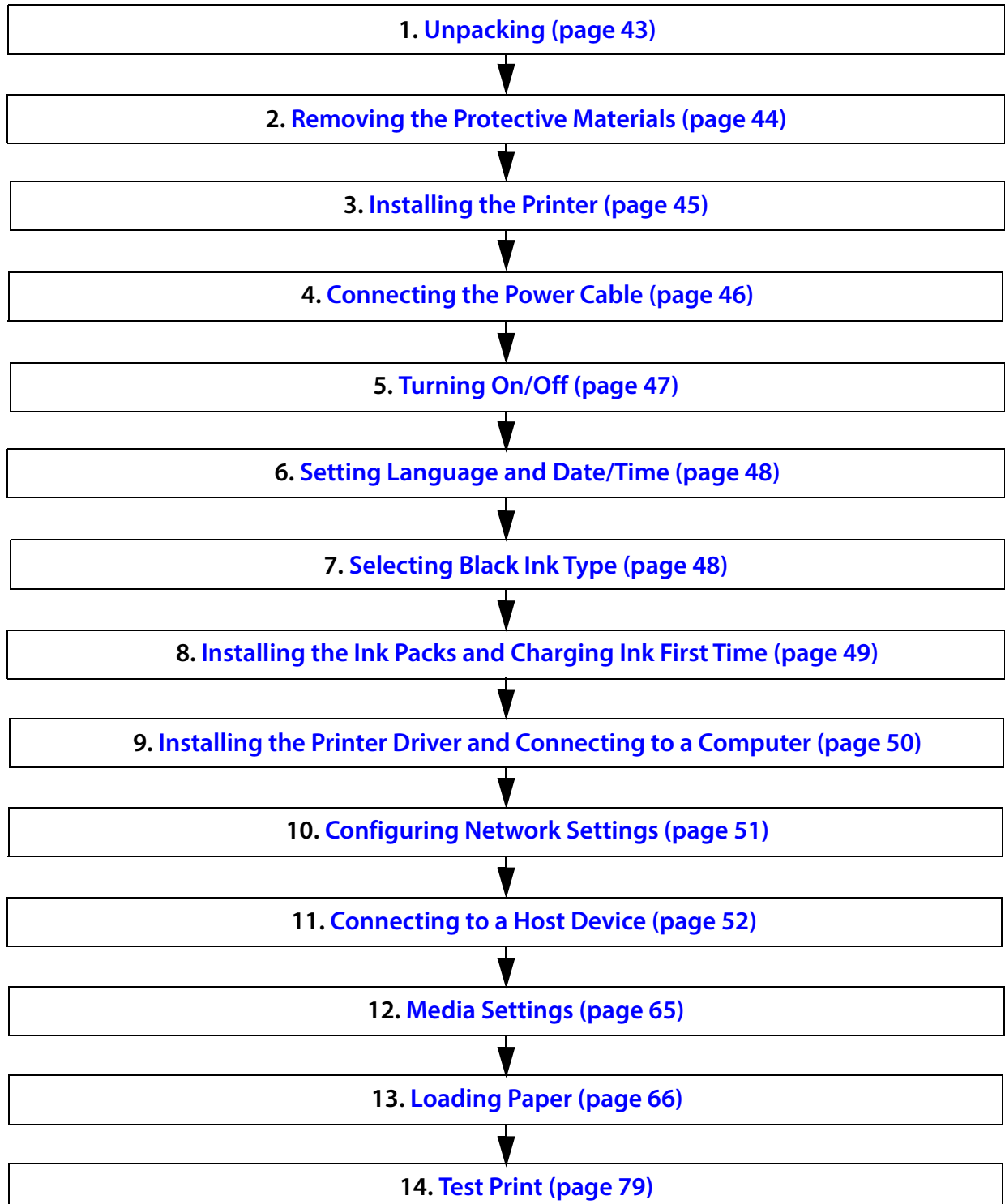

Unpacking

After unpacking, make sure that all the printer and the accessories are included and they have no damage.
The included items are as follows.

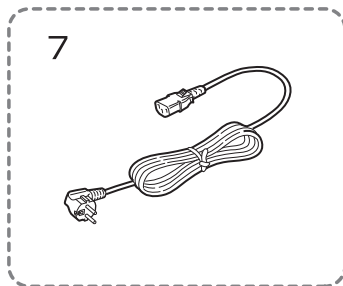
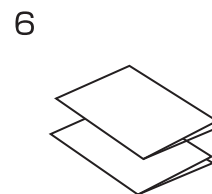
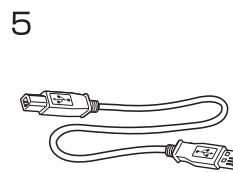
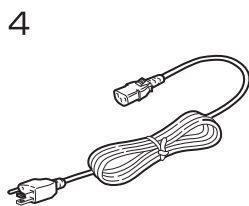
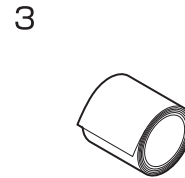
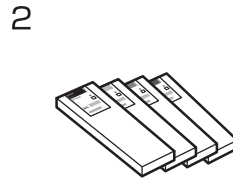
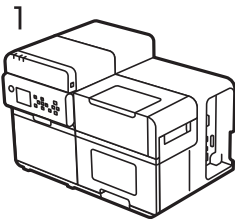

1	Printer (CW-C8000 Series)	2	Ink packs C, M, Y, BK (MK)* (For initial ink charging) * Either one of a BK (gloss black) pack or MK (matte black) pack is included.
3	Roll paper (for initial operation check)	4	Power cable
5	USB cable	6	Manual
7	Power cable*		

*The plug shape varies depending on the product model.



The maintenance box is already installed on the printer. Check below for replacement instructions.

 ["Replacing the Maintenance Box" on page 88](#)

Removing the Protective Materials

Remove all protective materials such as tape and cushioning material. Open the covers and remove any protective materials inside the product as well.

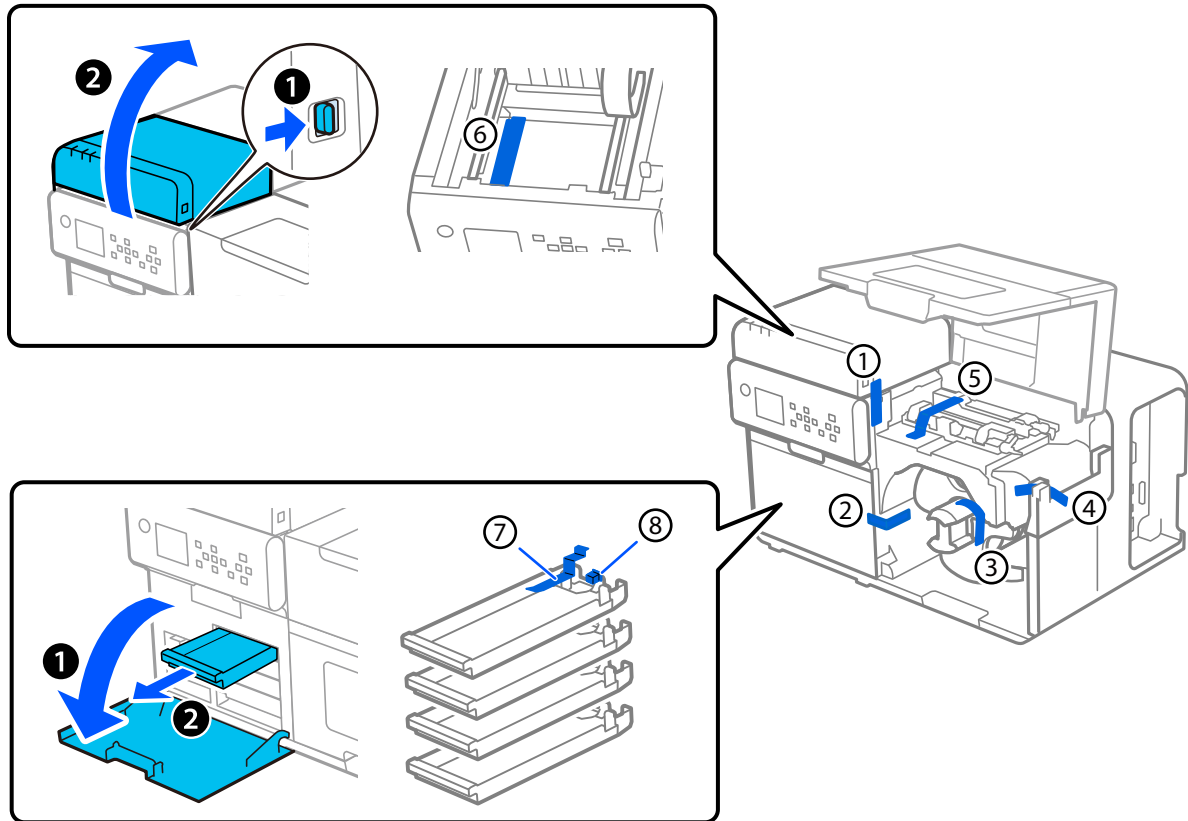

Installing the Printer

Allow sufficient space for the printer. Make sure that the installation location meets the following requirements.

- Level, stable flat surface strong enough to support the weight of the printer (approx. 35.0kg {77.16 lb}).
- Flat surface larger than the area of the bottom of the printer
- A location free from vibration and shock
- A location where a dedicated power outlet for the printer is available
- A location where paper can be set and removed without difficulty
- A location where there is enough space around the printer to install accessories, replace consumables, and perform routine maintenance without difficulty
- A well-ventilated location with at least 10 cm {3.94 in.} clearance from the air vent on the right side of the printer
- A location that meets the following environmental requirements.

For more details, see "[Environmental Specifications](#)" on page 393.

		Temperature	Humidity
Printing		5 to 35°C {41 to 95°F}	20 to 80% RH, No condensation
Storage	With gloss black ink	-15 to 40°C {5 to 104°F}	5 to 85% RH, No condensation (without being unpacked)
	With matte black ink	-10 to 40°C {14 to 104°F}	



If the printer has installed matte black ink and is likely to be exposed to temperatures below -10°C {14°F}, be sure to drain the ink before turning off the printer. Otherwise, the print head may be damaged due to freezing. For more details, see "[Storing the Printer After Ink is Charged](#)" on page 298.

Connecting the Power Cable

Follow the procedure below to connect the power cable.



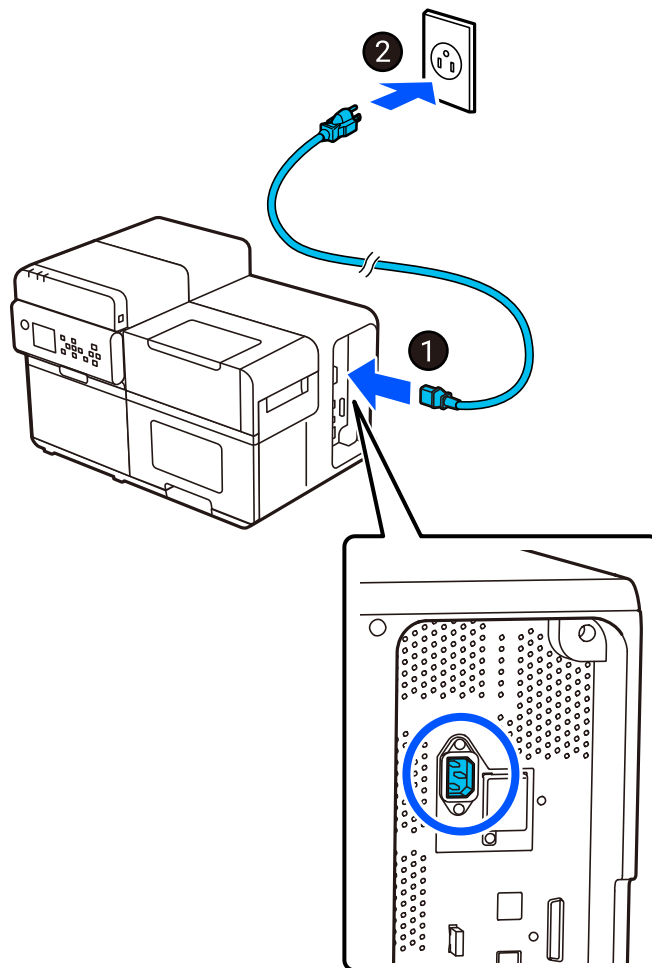

- Do not use the product with any power supply or voltage other than the ones specified.
- Install the printer near a wall outlet so that you can disconnect the plug from the outlet immediately in the event of an emergency.

- 1** Securely plug the power cable all the way into the power connector on the right side of the printer.
- 2** Insert the power plug securely all the way into a grounded outlet.





Turning On/Off

Turning the Power On

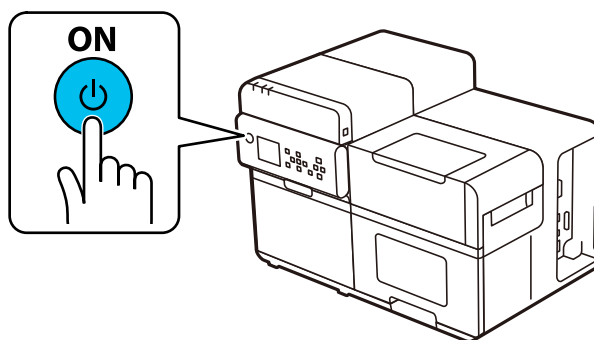
Hold down the  (power) button until the  (power) LED lights up.



Turning the Power Off

Hold down the  (power) button until a power-off confirmation message is displayed. Then select [Yes] on the confirmation screen. The  (power) LED goes out and the printer is turned off.

Setting Language and Date/Time

Follow the on-screen instructions to set language, the date and time.

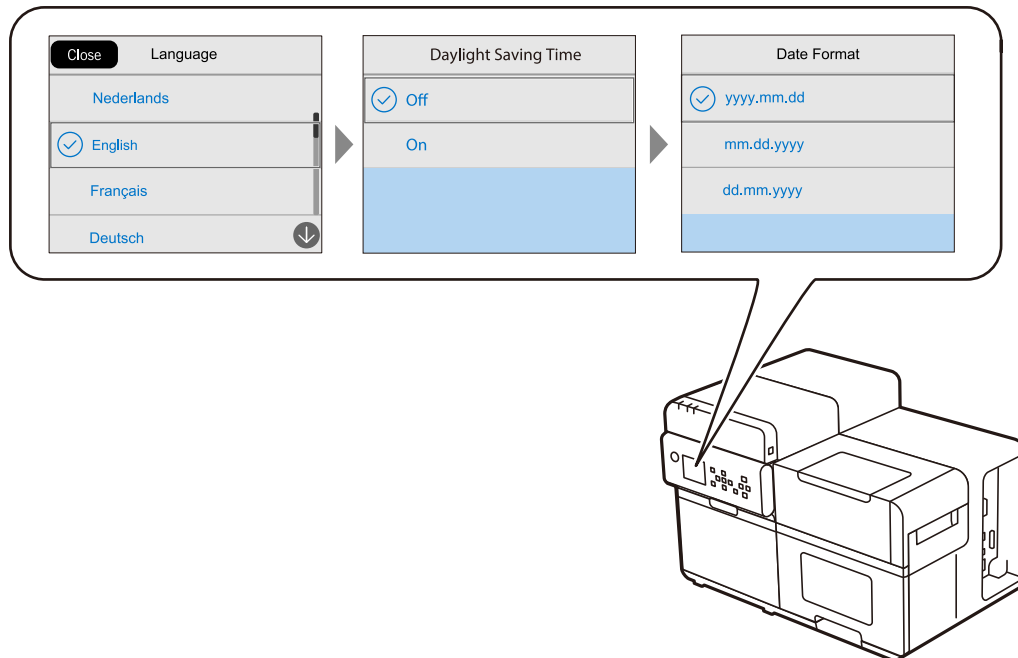

Selecting Black Ink Type

Follow the on-screen instructions.

- 1** Select the type of black ink to be used.
- 2** Select [Done] to confirm your selection.

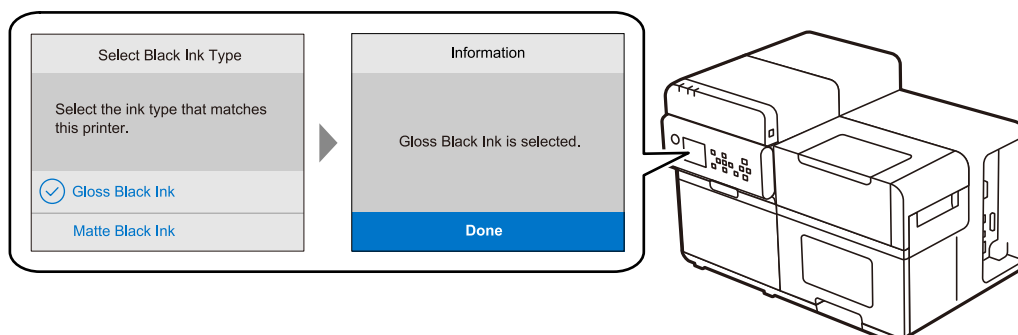

Installing the Ink Packs and Charging Ink First Time

Shake and then install the ink packs following the on-screen instructions.

When you close the cover, a message that confirms whether to start initial ink charging is displayed. Select [Yes] to start the initial ink charging. When you see a message saying that the initial ink charging is finished, select [OK].

It takes about 10 minutes for the initial ink charging. The time differs according to circumstances.



CAUTION

- If a different type of black ink from the selected black ink type is installed in the printer, initial ink charging will not be possible. The black ink type cannot be changed after the initial ink charging has started.
- The time it takes to charge ink depends on the situation.
- Never open the printer covers or turn off the power while ink charging is in progress. If these operations are performed during ink charging, ink will be significantly consumed and the ink packs may need to be replaced before charging is complete.
- Do not grip the ink pack tightly. Ink may leak from the pack.

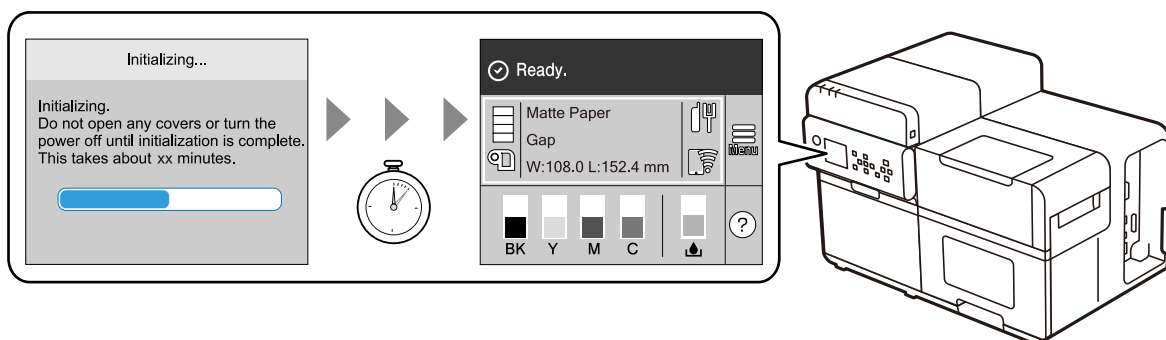
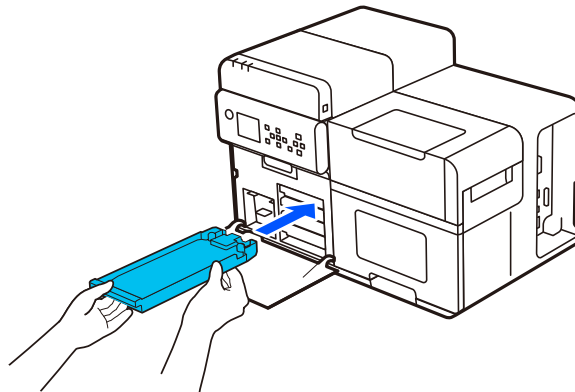

Check below for instructions on how to replace the ink packs.

 ["Replacing the Ink Packs" on page 84](#)

Installing the Printer Driver and Connecting to a Computer



Do not connect the printer to your computer until the screen prompts you to do so.

1 Go to the website below and search for your printer model number to download the printer driver.

You can get the software from the following website.

For customers in North America, go to the following web site: <https://www.epson.com/support/>

For customers in other countries and regions, go to the following web site: <https://epson.sn>

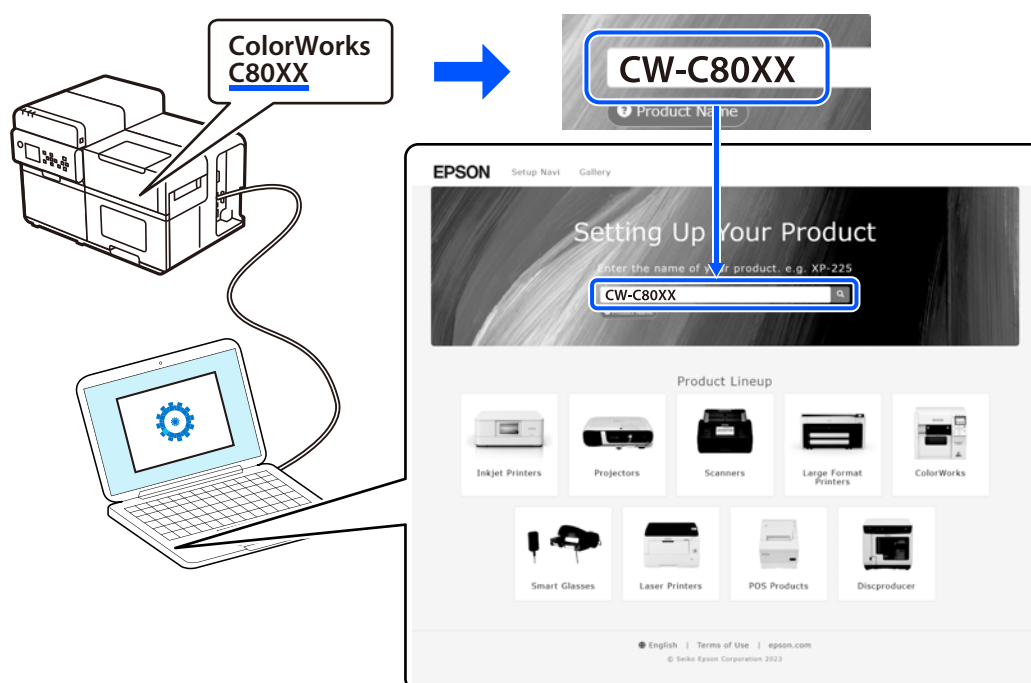

2 Start the printer driver.

3 Follow the on-screen instructions to install the printer driver.

During the installation process, you will be guided to connect the computer to the printer.

Configuring Network Settings

Follow the procedure below to set up the IP address of the printer.

- 1** Select [Menu] on the home screen.
- 2** Select [General Settings] - [Network Settings] - [Advanced] - [TCP/IP].
- 3** Select [Obtain IP Address] and then select [Auto] or [Manual].
When you select [Auto], the network setting is complete.
When you select [Manual], proceed to step 4.
- 4** Enter the IP address and the subnet mask.
Select a setting to change and then press the [OK] button to enter the information.
- 5** Select [Start Setup].

The network setting is now complete.

Connecting to a Host Device

- When connecting via USB or Wired LAN
Connect the corresponding interface cable to the connector on the right side of the printer.
- When connecting via Wireless LAN
Connect the optional OT-WL06 to the connector on the right side of the printer.

Connecting to Wired LAN

Connect to the network with a LAN cable and check the connection.

- 1 Connect the printer and a hub (or LAN switch) with a LAN cable.**
- 2 Select [Menu] on the home screen.**
- 3 Select [General Settings] - [Network Settings] - [Connection Check].**
The result of the check is displayed. Confirm that the printer is properly connected to the network.

Connecting to Wireless LAN (Wi-Fi) using a Wireless LAN Router

By connecting the optional wireless LAN unit (OT-WL06) to the printer, the printer can communicate over a wireless LAN. There are several ways to connect the printer to a wireless LAN (Wi-Fi). Select the connection method that best suits your environment and conditions.

The following two connection methods using a wireless LAN router are introduced here.





For information (SSID, password) of the wireless LAN router (access point), please check your router or if inaccessible then contact your network administrator.

- ["Connecting using SSID and Password" on page 53](#)
- ["Connecting using Push Button \(WPS\)" on page 57](#)



- If  is not displayed on the home screen, check that the optional wireless LAN unit is properly connected, and turn the printer off and then back on.
- When Wi-Fi Direct is enabled, the printer acts as an access point and can be connected to up to eight devices.
["Connecting to Wireless LAN \(Wi-Fi\) using Wi-Fi Direct" on page 59](#)

Connecting using SSID and Password

- 1 Connect the optional wireless LAN unit to the printer, and turn the printer on.
- 2 Press    to select  on the printer's home screen, and then press the OK button.

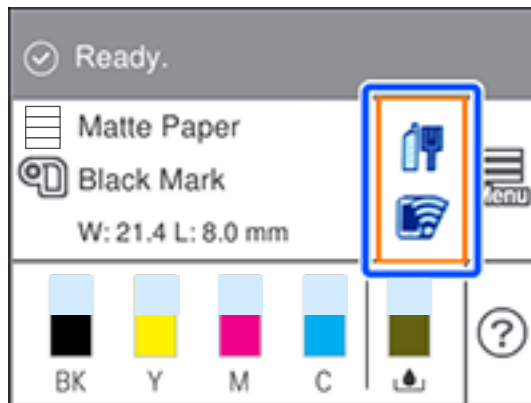

- 3 Select [Router], and then press the OK button.

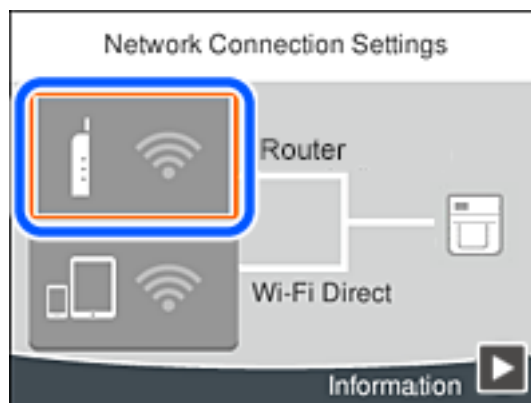

- 4 Press the OK button.



- 5 Select [Wi-Fi Setup Wizard], and then press the OK button.



- 6 On the printer's control panel, select the network name (SSID) for the wireless router that you want to connect to.

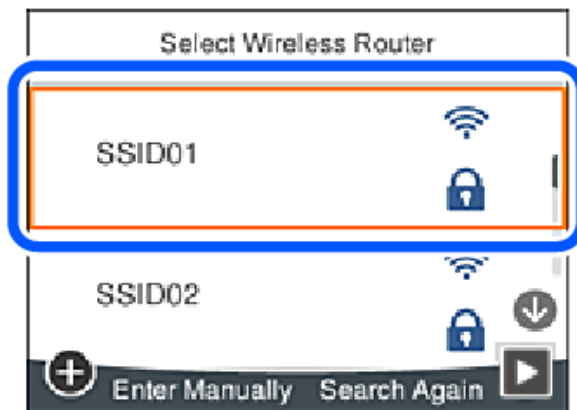

- 7 Select the [Enter Password] on the [Enter Manually] screen, and then press the OK button.



If you enter the SSID manually, set [Password] to [Available], select [Enter Password], and then press the OK button.

8 Enter the Wi-Fi password.

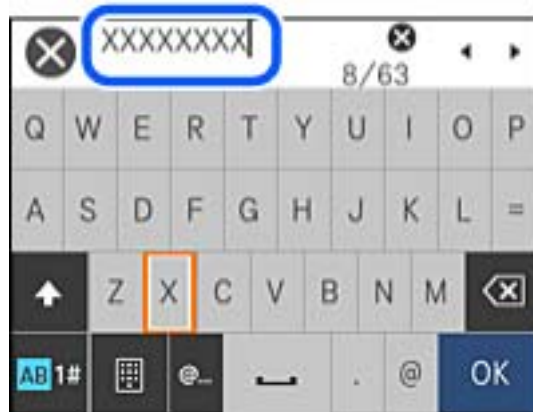

- The password is case-sensitive.
- If you do not know the password, check if the information is written on the label of the wireless router. On the label, the password may be identified as a "Network Key," "Wireless Password", and so on. If you are using the wireless router at its default settings, use the password written on the label.

9 When you have finished, select [OK], and then press the OK button.



10 Check the settings, select [Start Setup], and then press the OK button.



11 Press the OK button.



Even if you do not press the OK button, the screen will change to the next screen after a certain period of time.



If you fail to connect, make sure paper is loaded, and then print a connection report. Select [Print Check Report], and then press the OK button.

12 Press the button.

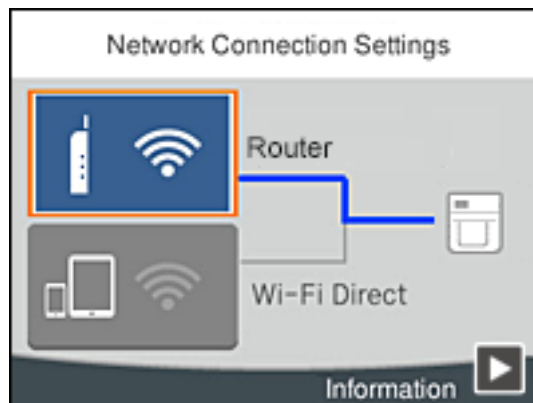

Connecting using Push Button (WPS)

- 1 Connect the optional Wireless LAN Unit to the printer, and turn the printer on.
- 2 Press ◀▶▶ to select  on the printer's home screen, and then press the OK button.

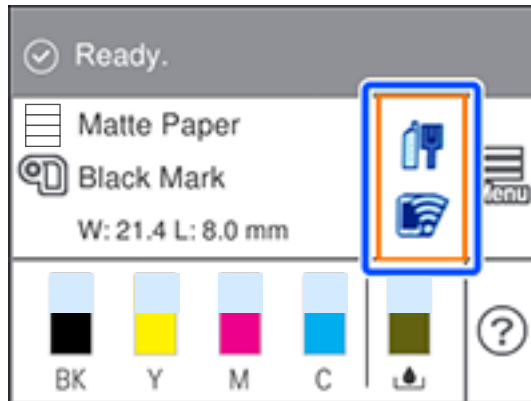

- 3 Select [Router], and then press the OK button.

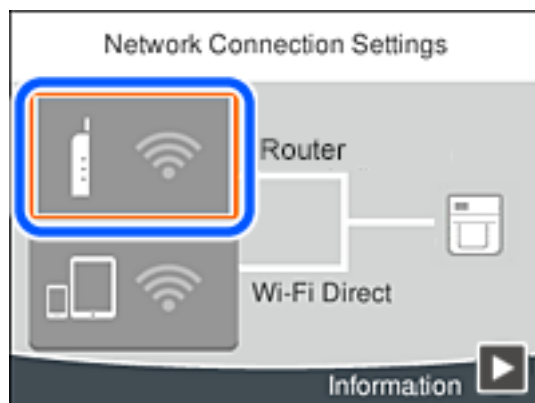

- 4 Press the OK button.



- 5** Select [Push Button Setup (WPS)], and then press the OK button.



- 6** Hold down the [WPS] button on the wireless router until the security light flashes. If you do not know where the [WPS] button is, or there are no buttons on the wireless router, see the documentation provided with your wireless router for details.

- 7** Press the OK button on the printer's operation panel.



- 8** Press the OK button.



Even if you do not press the OK button, the screen will change to the next screen after a certain period of time.

9 Press the  button.

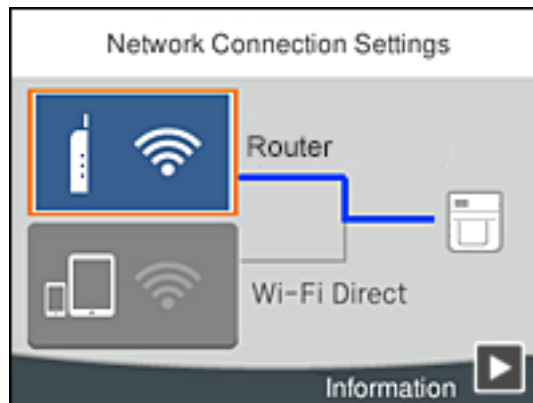





Connecting to Wireless LAN (Wi-Fi) using Wi-Fi Direct

Wireless LAN communication with the printer is possible by connecting the optional wireless LAN unit (OT-WL06) to the printer. There are several connection methods. Select the connection method that best suits your environment and conditions.

The following two connection methods using Wi-Fi Direct are introduced here.

- ["Connecting to an iOS Device" on page 59](#)
- ["Connecting to a Non-iOS Device" on page 62](#)

Connecting to an iOS Device

- 1 Connect the optional Wireless LAN Unit to the printer, and turn the printer on.
- 2 Press    to select  on the printer's home screen, and then press the OK button.

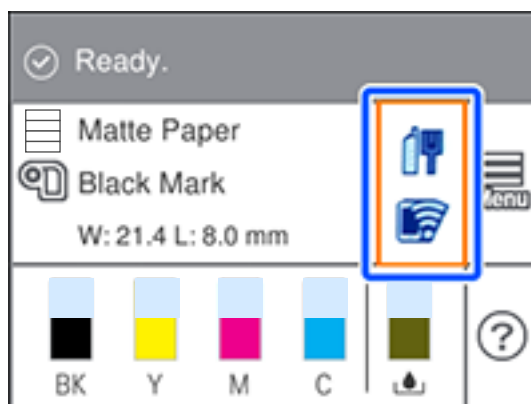

- 3** Select [Wi-Fi Direct], and then press the OK button.

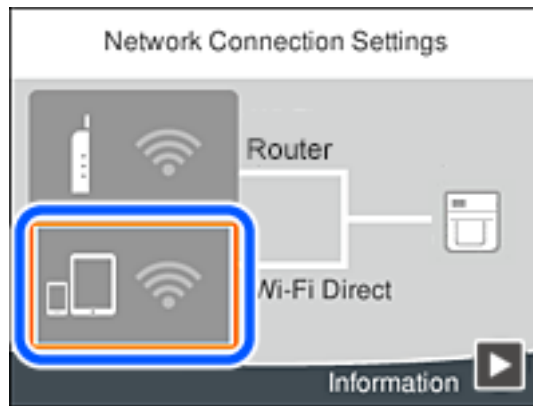

- 4** Press the OK button.



- 5** Select [iOS], and then press the OK button.

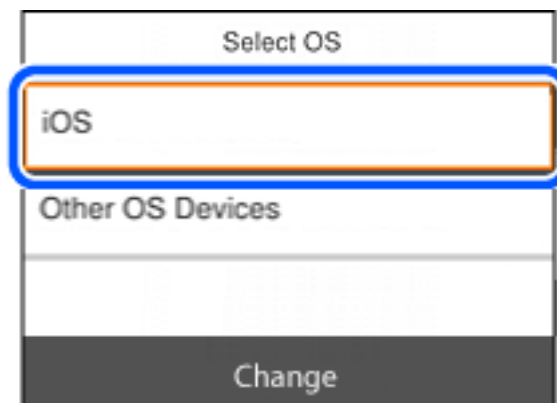

A QR code is displayed on the printer screen.

- 6** Open the OS-standard camera app.
This does not work with code reading apps.



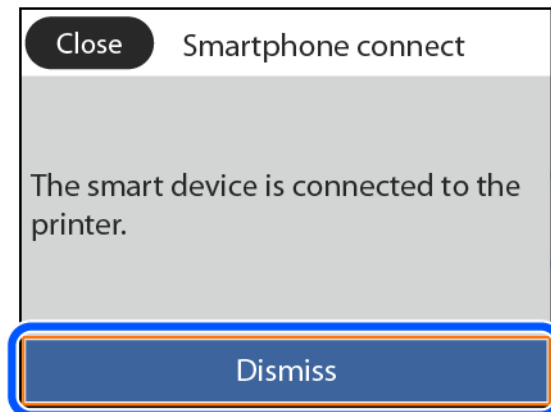

- 7 Scan the QR code in Photo mode and tap the notification that appears to connect to the printer.
- 8 Press the OK button.

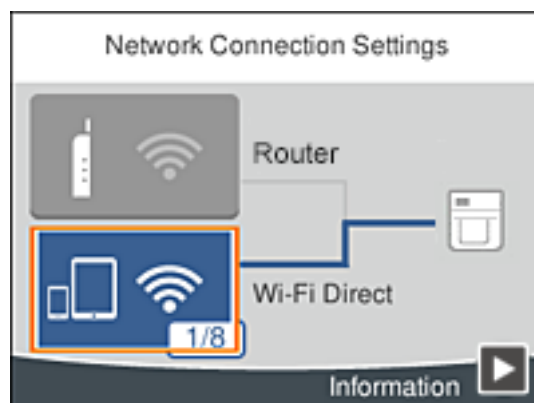

- 9 Select [Complete], and then press the OK button.
- 10 Press the  button.



Connecting to a Non-iOS Device

- 1 Connect the optional Wireless LAN Unit to the printer, and turn the printer on.
- 2 Press    to select  on the printer's home screen, and then press the OK button.

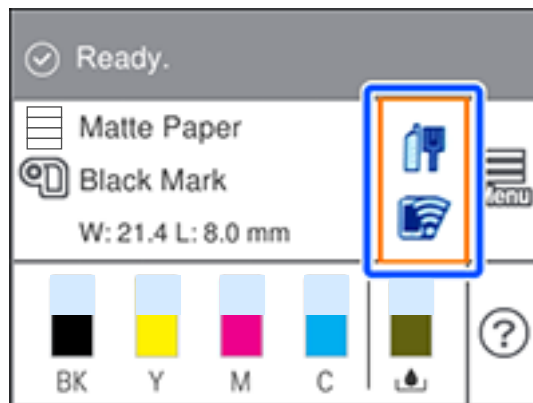

- 3 Select [Wi-Fi Direct], and then press the OK button.

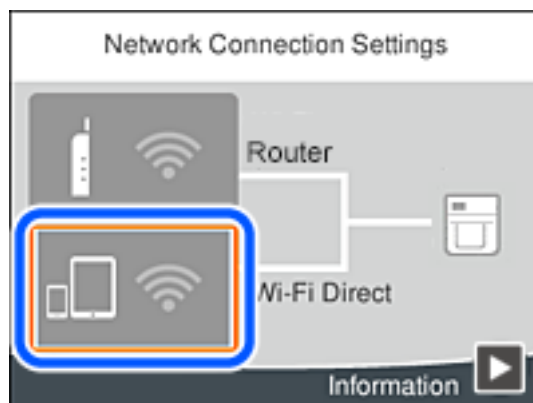

- 4 Press the OK button.



- 5** Select [Other OS Devices], and then press the OK button.

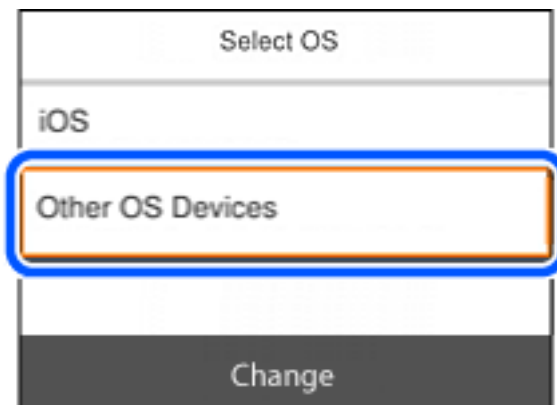

- 6** Perform this step on your computer. On the computer's network connection screen, select the SSID displayed on the printer's control panel.

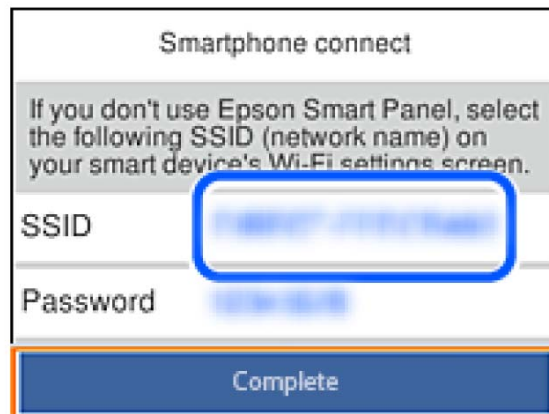

- 7** Enter the password displayed on the printer's control panel on the computer to connect to the printer.

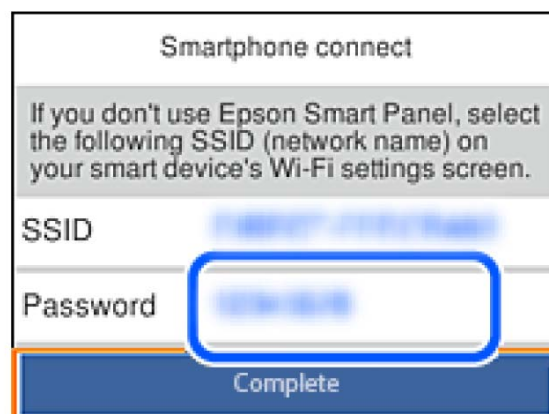

- 8 After the connection is established, select [Complete], and then press the OK button.

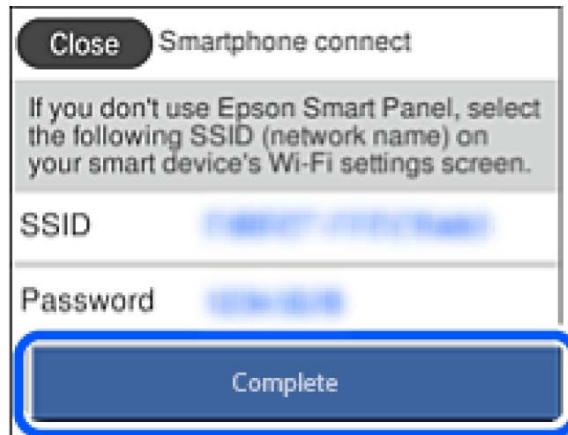

- 9 Press the  button.

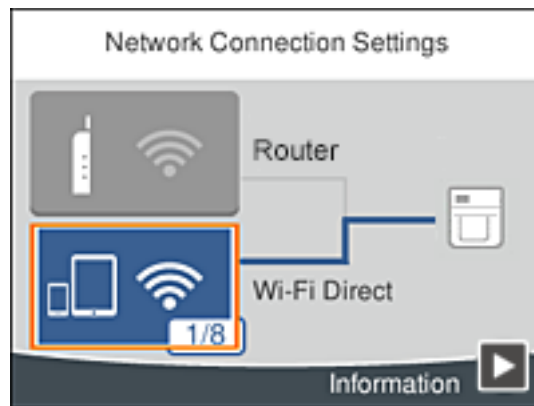

Media Settings

Configure media (paper) settings such as how to feed and detect paper, and the shape and type of paper.

- Setting using the printer driver

[Printer driver for Windows](#)

[Printer Driver for Mac](#)

[Printer Driver for Linux](#)

- Changing the settings on the printer

[PrinterSetting \(Windows\)](#)

[Epson Label Printer Utility](#)

[Epson Label Printer Utility for Linux](#)

[Web Config](#)

[Operation Panel](#)



- If the settings on the printer (settable using the operation panel, PrinterSettings, or Web Config) differ from the printer driver settings, printing is performed by applying the printer driver settings.
- For media that can be used with this product, refer to "[Paper Specifications](#)" on [page 370](#).

Loading Paper

This section describes how to load and replace paper. The procedure for replacing paper varies depending on whether the paper is fed from inside or outside the printer.

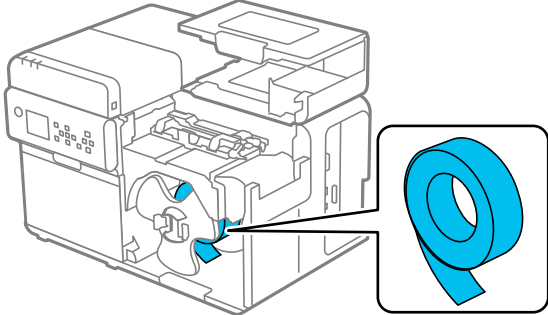
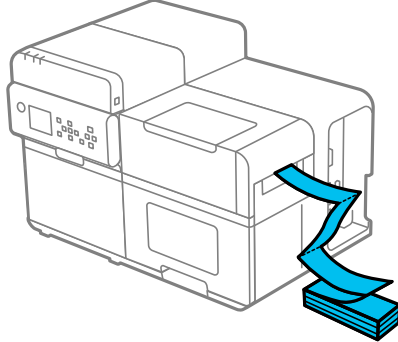
Feeding paper from Inside (Internal)	Feeding paper from Outside (Rear Feed)
<p>Paper is supplied from inside the printer. Set roll paper attached into the printer. "Loading Roll Paper" on page 67</p> 	<p>Paper is supplied from outside the printer. Place fanfold paper on the right side of the printer. "Loading Fanfold Paper" on page 72</p> 



- To feed roll paper from outside the printer, prepare an external paper feeder by yourself. For more details, contact qualified service personnel for advice.
- If you want to wind up printed roll paper, please prepare the optional rewinder (TU-RC8000). For instructions on how to use the rewinder, see the section below.
["Rewinder \(TU-RC8000\)" on page 398](#)
- When replacing paper with a different shape, form, or type of paper, change the paper settings either from the operation panel or on the printer driver before loading the paper.
["Checking the Printer Status on the Printer Screen" on page 38](#)
["Media \(Paper\) Settings" on page 93](#)
- Depending on the thickness of the paper, the gap between the print head and the paper may not be appropriate, resulting in blurred printing, double characters, or paper smudging due to rubbing between the print head and the paper. Adjust the gap using the [Head-Media Clearance Height] menu.
["Adjusting Head-Media Clearance Height" on page 292](#)

Loading Roll Paper



Watching the Video on How to Load Paper

https://support.epson.net/p_doc/95e/

📄 Loading Roll Paper/Fanfold Paper in the Printer (CW-C8000 Series)

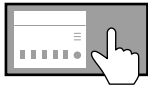

Viewing How to Load Paper on the Operation Panel

? (Help) – [How To...] – [Load Media] - [Internal]



After turning on the printer, wait until the home screen is displayed, and then open the paper cover. If you open the cover before the home screen is displayed, the printer may fail to load the paper correctly.

- 1 Turn the printer on.
📄 "Turning the Power On" on page 47
- 2 Wait until the home screen appears.
- 3 Open the paper cover.

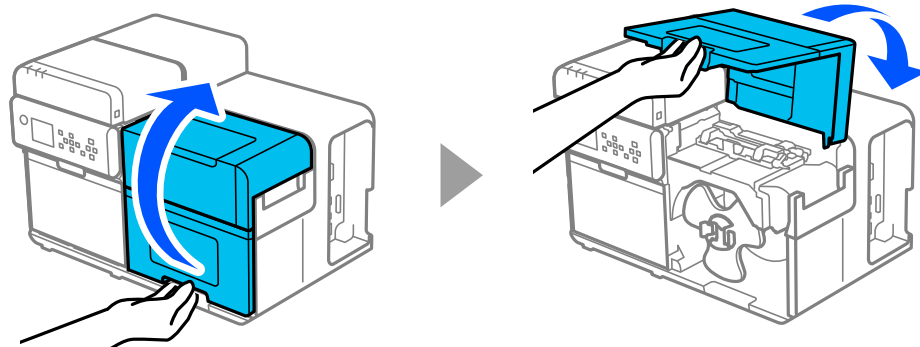

- 4 Remove the roll paper flange from the spindle while squeezing the levers of the flange.

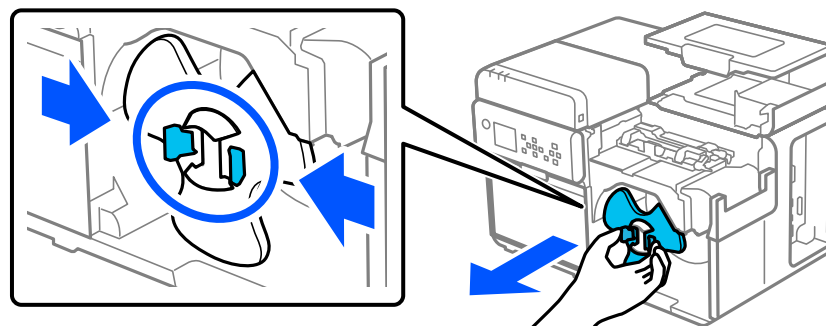

- 5** Attach a paper roll to the spindle and push the roll as far as it goes by pressing its core.

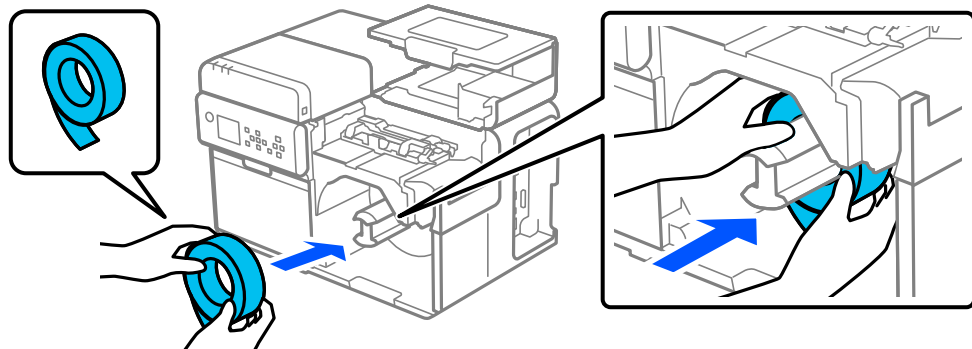

- 6** Attach the roll paper flange to the spindle while squeezing the levers of the flange. Move the flange until it touches the roll paper so that there is no gap in between.

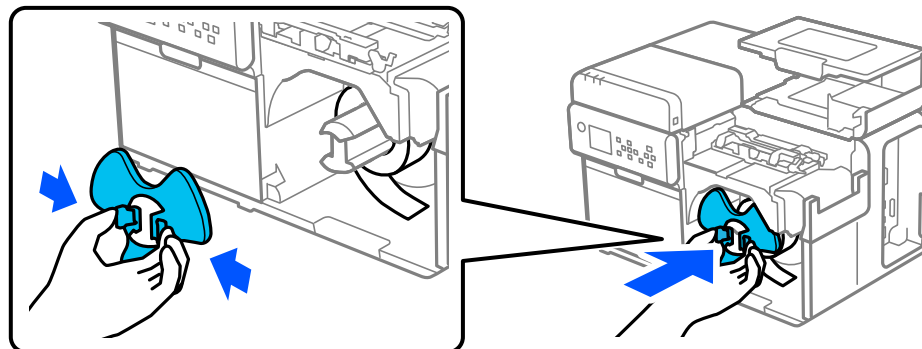

- 7** Turn the flange clockwise until the leading edge of the paper touches the bottom, and pull out the paper by approximately 300 mm {11.81 in.}.

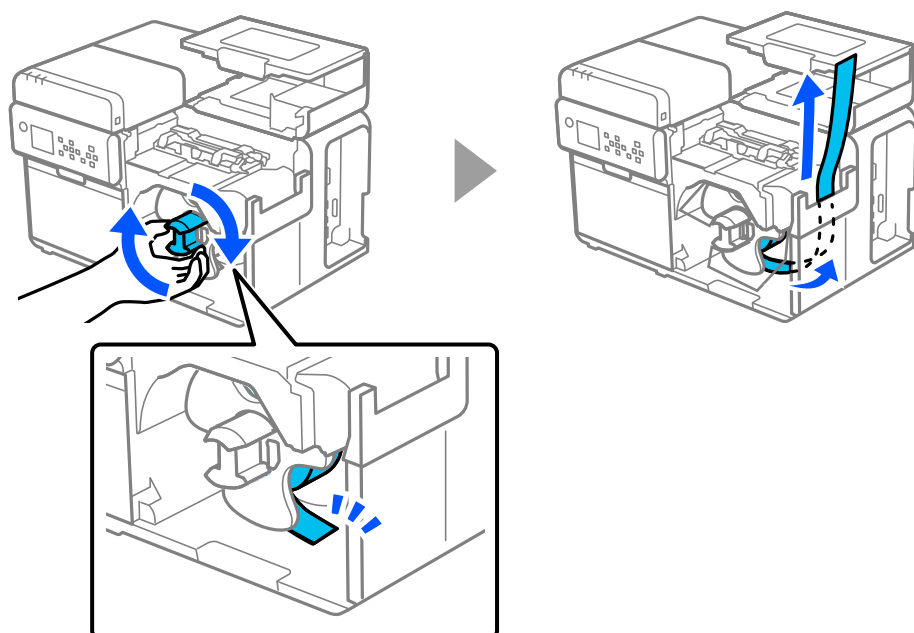

8 Raise the paper holds.

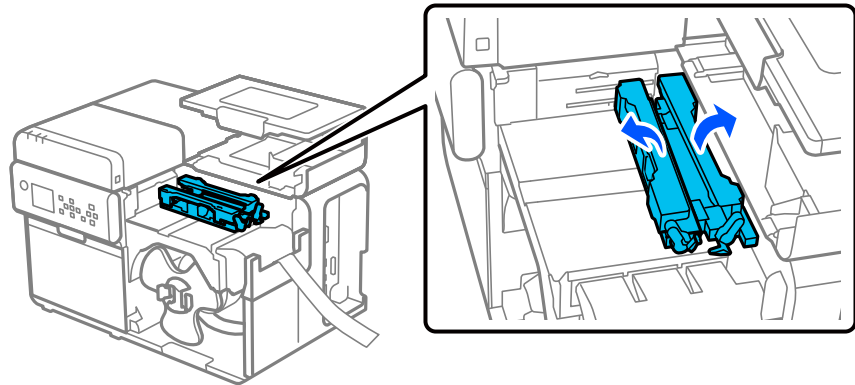

9 While pressing the blue lever, slide the movable edge guide toward you until it stops.

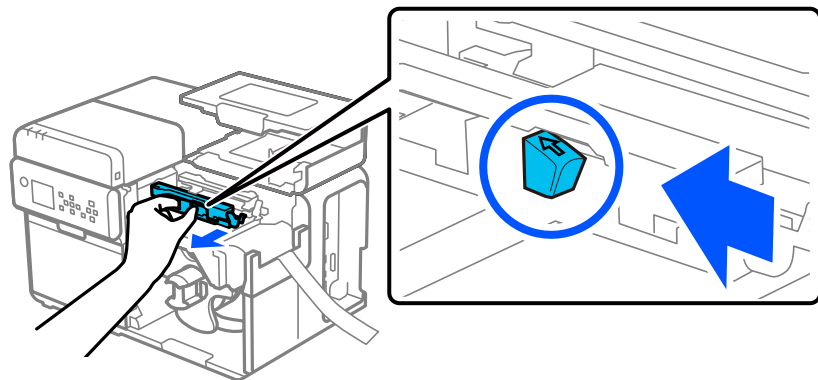

10 Place the paper in the paper path along the edge guide and align the leading edge with the mark.

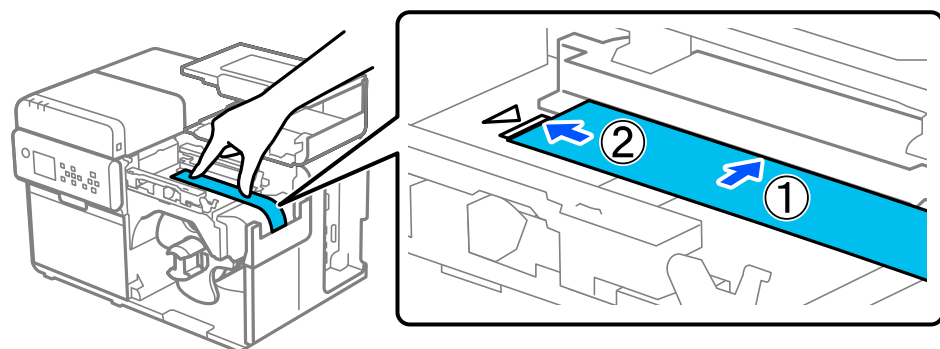

Make sure the leading edge of the paper has no creases, tears, wrinkles, peeling labels, or other deformities. Inserting deformed paper may cause an error in paper feeding, misprinting, or paper jamming.

- 11** Hold down the paper with your hand to keep it flat, and while pressing the blue lever, slide the movable edge guide against the paper.

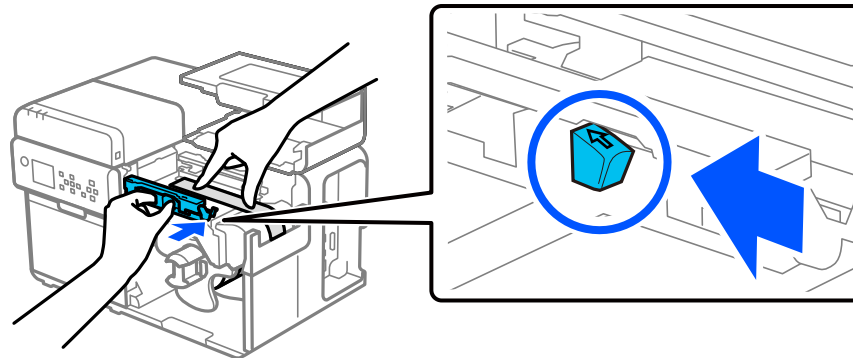
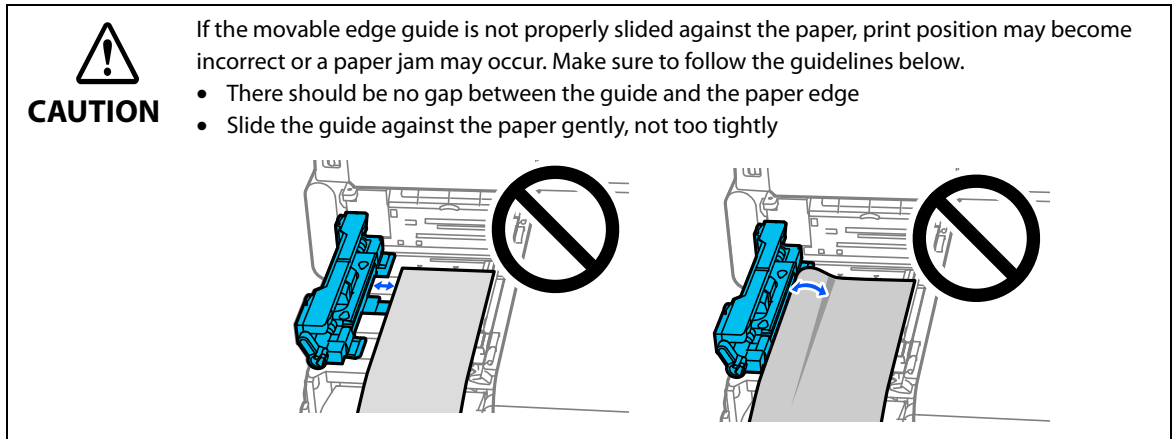

- 12** Insert the leading edge of the paper into the slot until the paper is automatically fed into the printer.

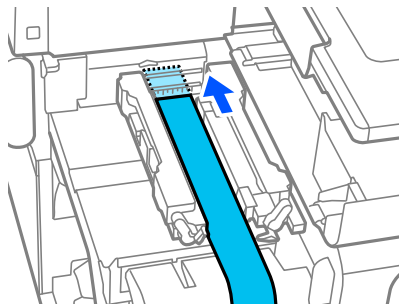

13 Lower the paper holds.

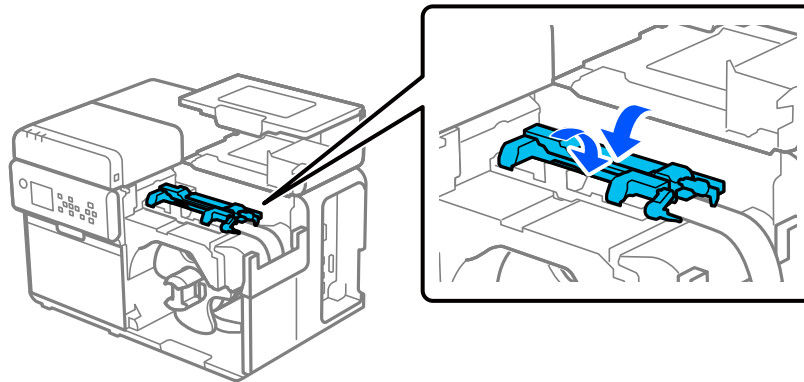

14 Turn the flange clockwise to take up the slack in the roll paper.

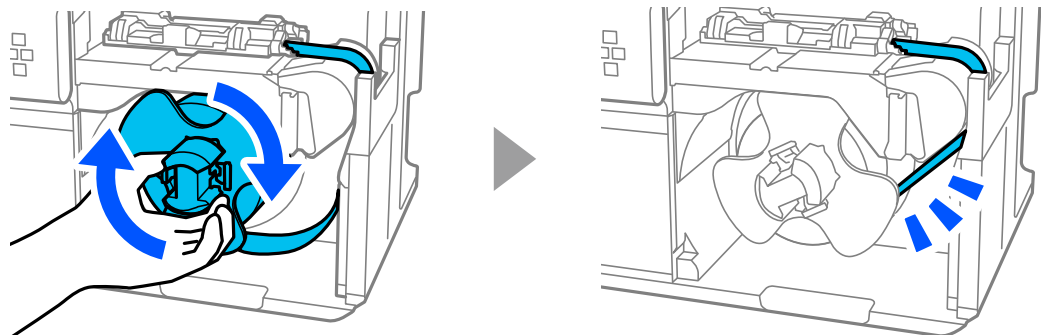

15 Close the paper cover.

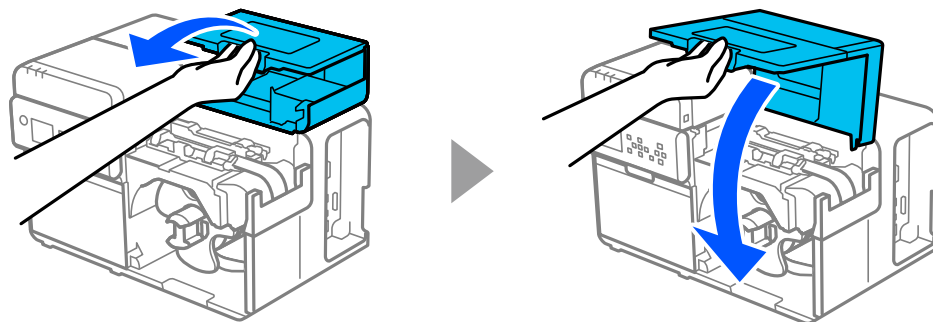

16 Press the **||** (pause) button.

Check that the printer is ready for printing by checking the home screen.

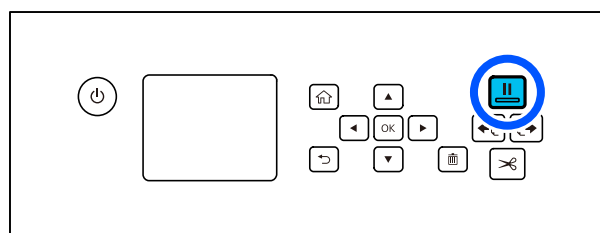

Loading Fanfold Paper



Watching the Video on How to Load Paper

https://support.epson.net/p_doc/95e/

📄 Loading Roll Paper/Fanfold Paper in the Printer (CW-C8000 Series)

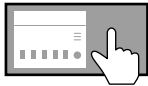

Viewing How to Load Paper on the Operation Panel

? (Help) – [How To...] – [Load Media] - [Rear Feed]



After turning on the printer, wait until the home screen is displayed, and then open the paper cover. If you open the cover before the home screen is displayed, the printer may fail to load the paper correctly.

- 1 Turn the printer on.
📄 "Turning the Power On" on page 47
- 2 Wait until the home screen appears.
- 3 Open the paper cover.

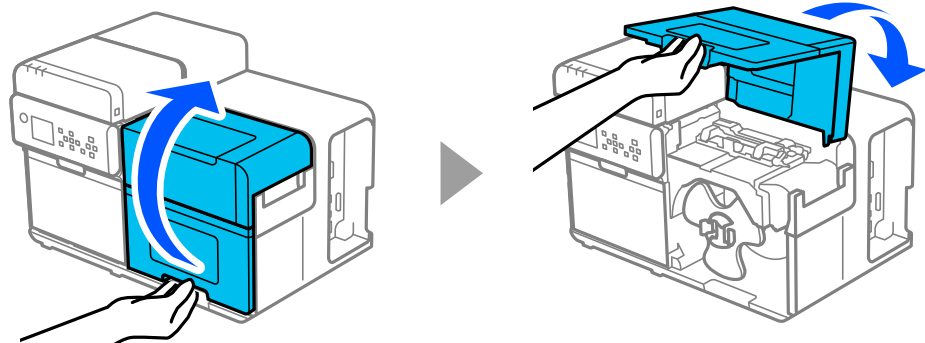

- 4 Raise the paper holds.

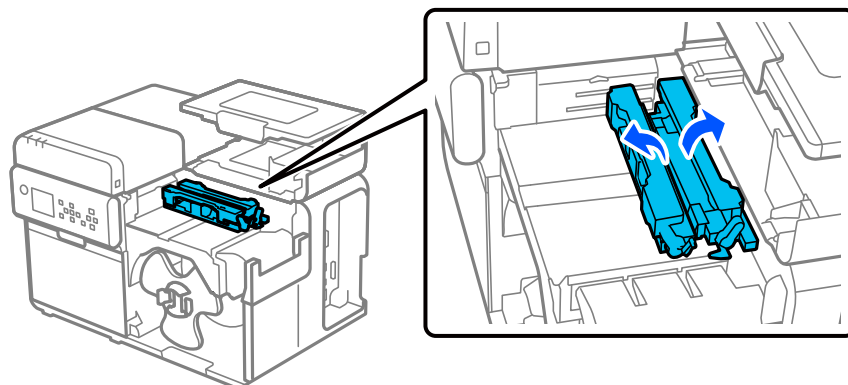

- 5** While pressing the blue lever, slide the movable edge guide toward you until it stops.

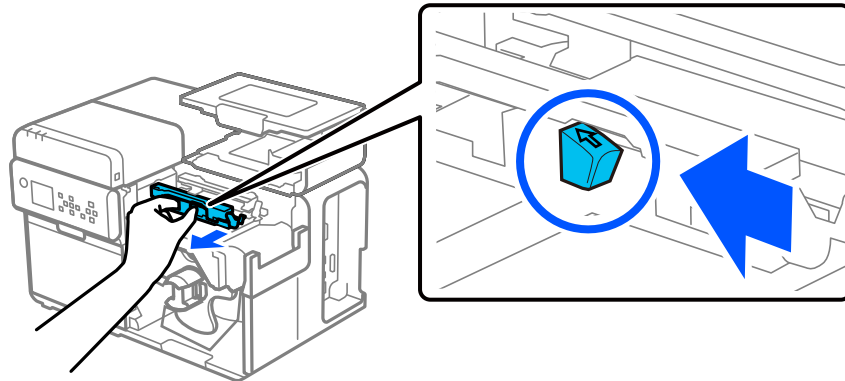

- 6** Place the paper in the paper path along the edge guide and align the leading edge with the ▽ mark.

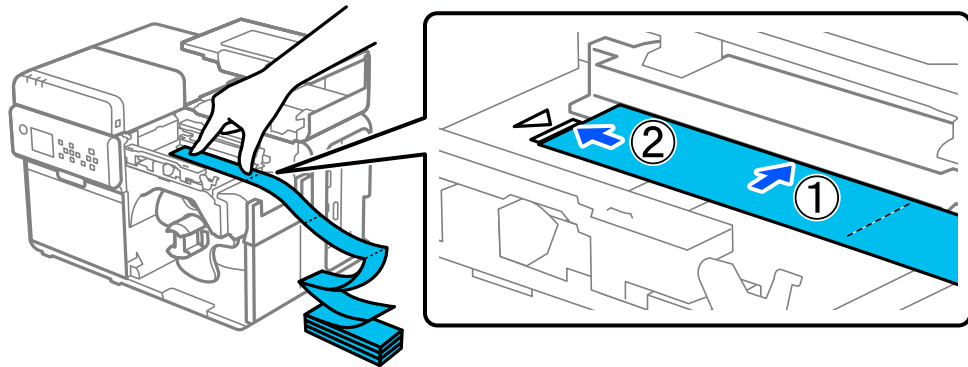

Make sure the leading edge of the paper has no creases, tears, wrinkles, peeling labels, or other deformities. Inserting deformed paper may cause an error in paper feeding, misprinting, or paper jamming.

- 7** Hold down the paper with your hand to keep it flat, and while pressing the blue lever, slide the movable edge guide against the paper.

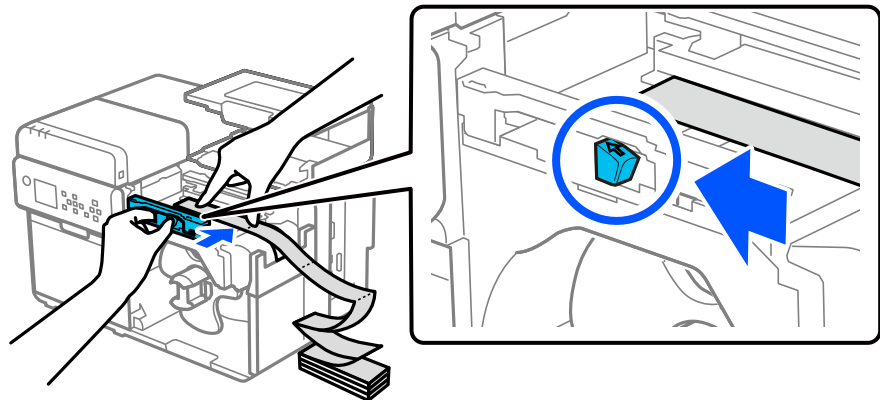
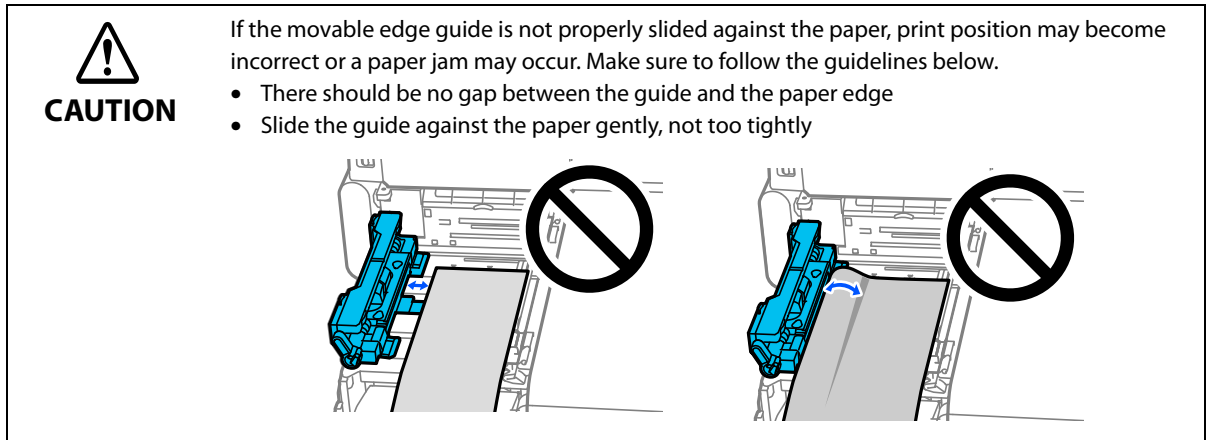

- 8** Insert the leading edge of the paper into the slot until the paper is automatically fed into the printer.

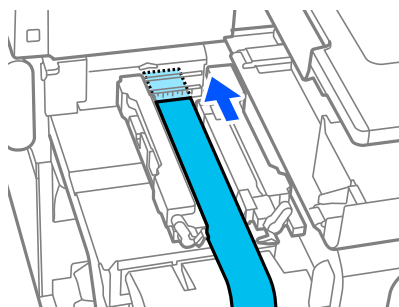

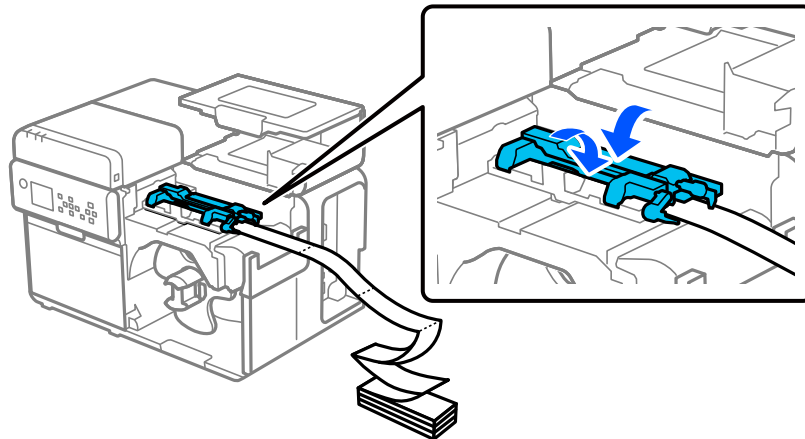
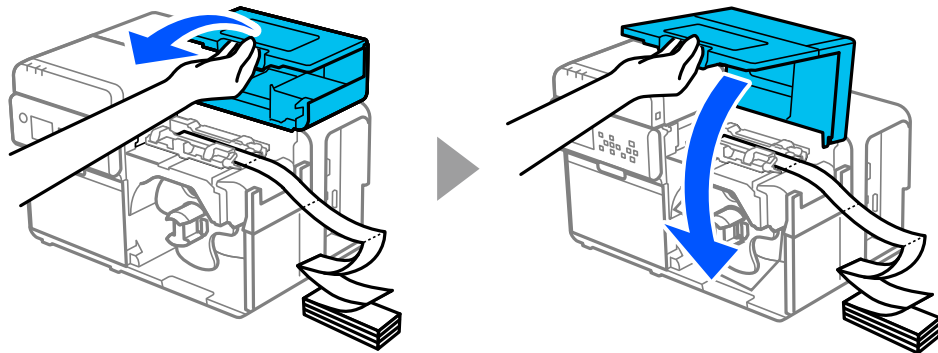
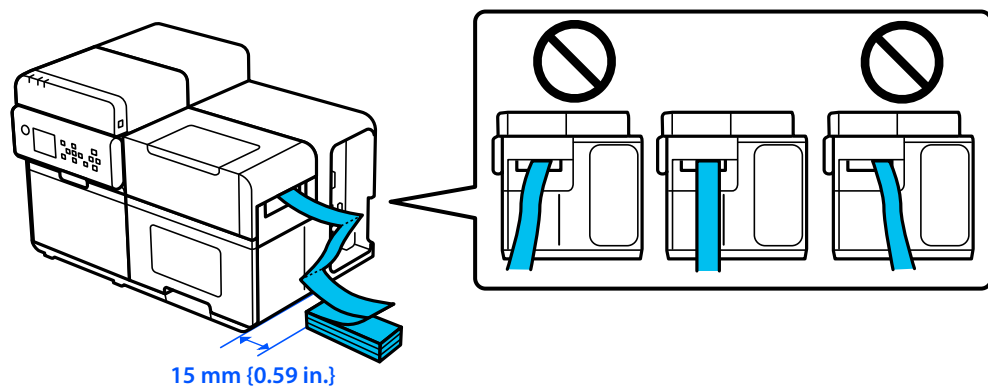
9 Lower the paper holds.**10** Close the paper cover.**11** Place the stack of fanfold paper at least 15 mm {0.59 in.} away from the printer. Be sure that the paper is fed in a straight line to the paper feed slot.

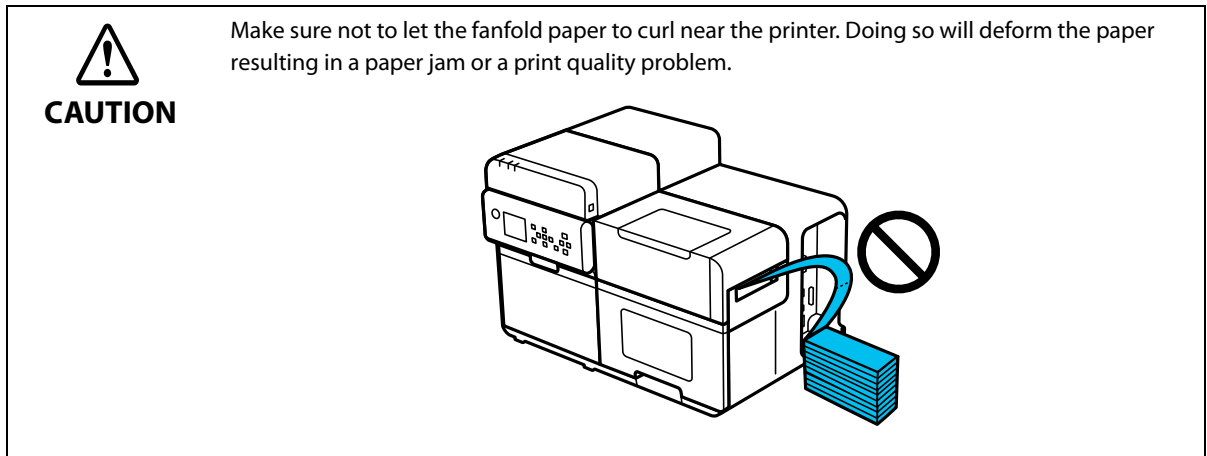

12 Press the **||** (pause) button.

Check that the printer is ready for printing by checking the home screen.

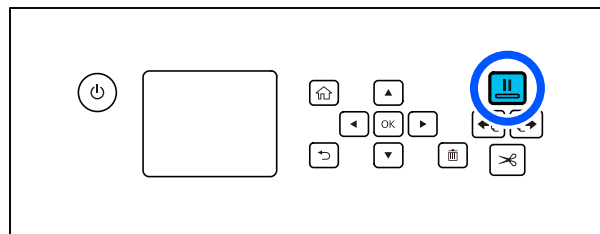

Ejection Angle of Printed Paper

Ensure that the printed paper is ejected straight from the ejection slot as shown in the figure below. If paper is not ejected straight due to obstructions or other factors, printing may be distorted.

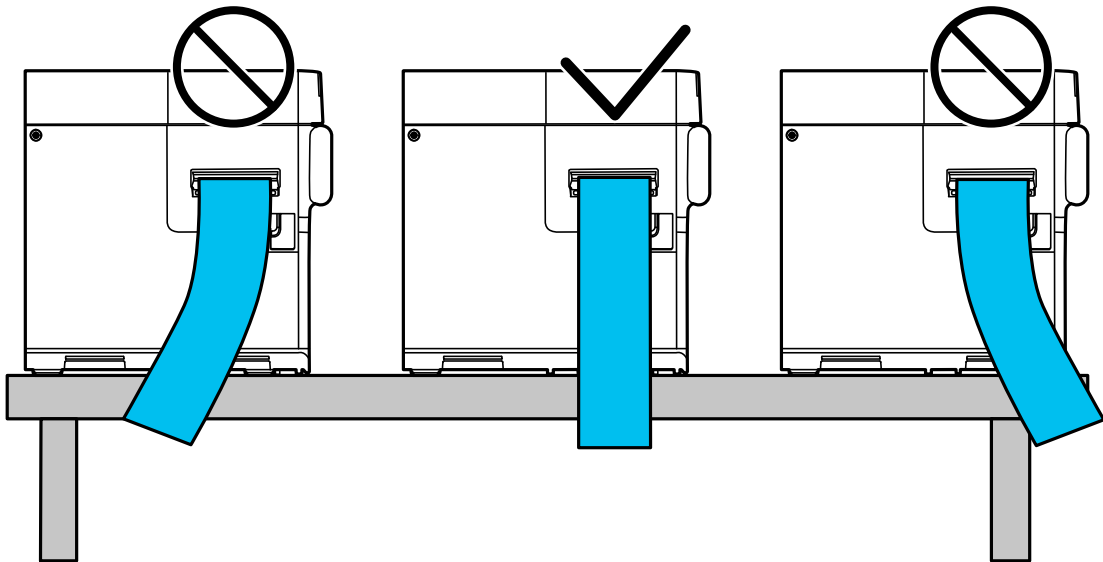

- When the printer starts printing, it retracts the label paper slightly to align the print start position with the next label to be printed. If the printer is located away from the computer, the printer user cannot know when the next print run will begin and when the label paper will be retracted. Therefore, when handling paper ejected from the printer, such as loading printed label paper into the rewinder, be sure to press the **||** (pause) button to stop the printer before doing so.
- If you need to separate the fanfold paper along the perforations after printing, do so after pressing the **||** (pause) button to stop the printer, or use the cut button to separate the paper. If the printer retracts the paper to start next printing while you manually separate the paper, a paper jam will result.
- Do not touch the paper during printing, as misalignment of the paper may cause a paper jam or misalignment of the print position.

Feeding Paper into the Printer Manually

If you are using a special paper, the printer may fail to detect the paper and the paper may not be fed into the printer automatically. In such case, follow the procedure below to feed the paper manually.



CAUTION

If this manual feeding method is used, the printer operation and print quality are not guaranteed.

- 1 Advance the paper with your hand until the leading edge comes in contact with the paper feed shaft.

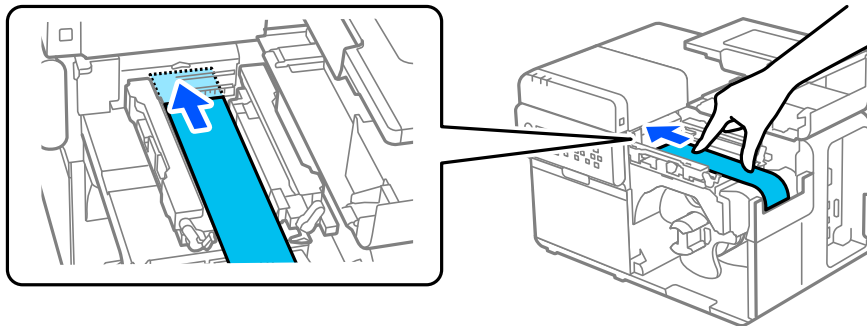

- 2 Hold down the paper with your hand and press the ← (feed) button.

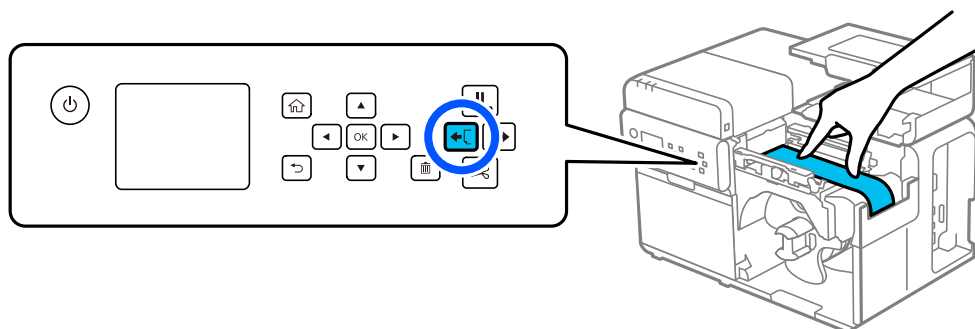

Test Print

You can check whether the printer operates normally or not by printing a nozzle check patterns.

Follow the procedure below to print the nozzle check patterns. The nozzle check patterns allow you to check print nozzles for clogging.

- 1** Turn the printer on.
- 2** Select [Menu] and then press the [OK] button.
- 3** Select [Maintenance].
- 4** Select [Print Head Nozzle Check].
- 5** Select [Print].
The nozzle check patterns are printed.
- 6** Check the printed nozzle check patterns.
When all nozzles are normal and not clogged, all lines are printed cleanly as shown in the left figure below. When some nozzles are clogged, there are broken lines and missing segments as shown in the right figure below. In this case, run the print head cleaning.

Example of the nozzle check patterns with gloss black ink

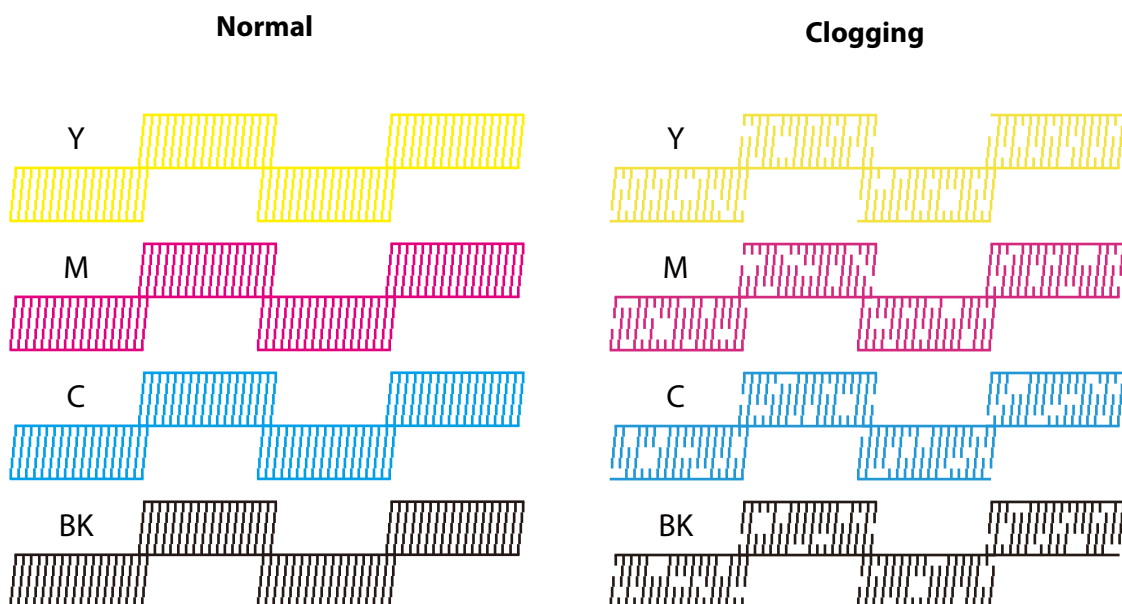

Self-Test Printing

If you have already installed the printer driver, you can do a test print using the printer driver. Follow the procedure below to do the test print.

- 1 Open [Printers & scanners].
- 2 Click the printer icon and click [Printer properties].
- 3 The Printer properties screen appears. Click [Print Test Page] on the screen.

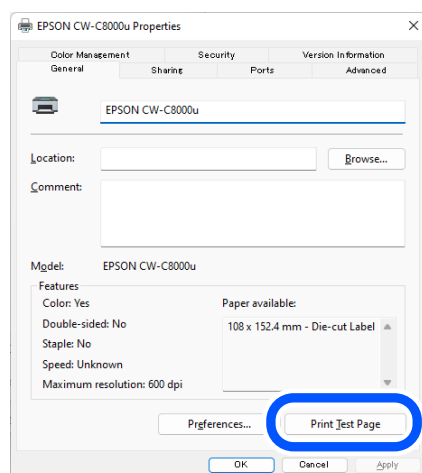



If the [Media Detect] setting has been set to [Gap] or [Hole], the test page is not printed from the first label. However, you can change to print from the first label if you do the settings described in the link below.

["Printing from the First Label" on page 289](#)

Removing Paper

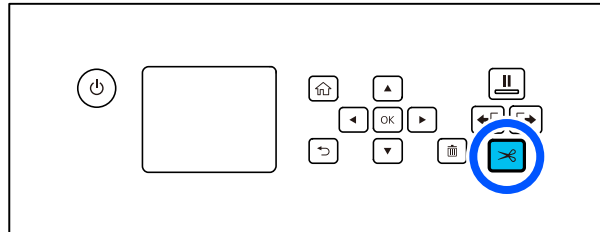
- 1 Cut the paper.



- 2 Hold down the  (back-feed) button until the paper stops moving.

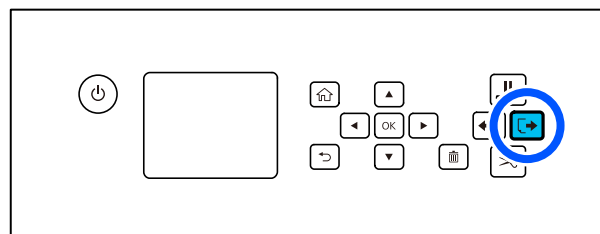

- 3 Open the paper cover.

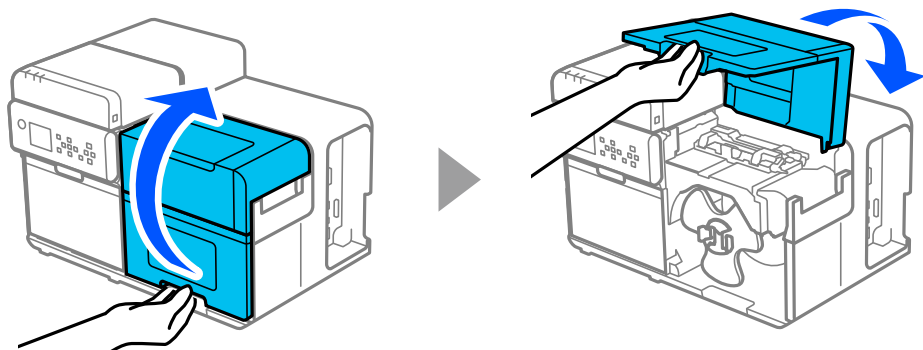

- 4 Remove the roll paper flange from the spindle while squeezing the levers of the flange.

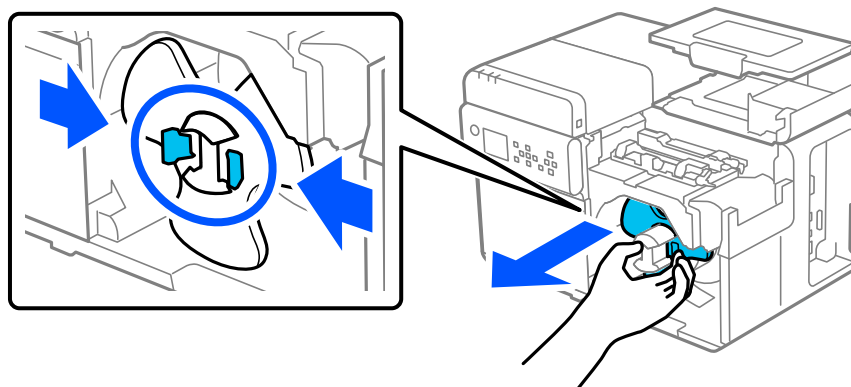

5 Remove the roll paper from the spindle.

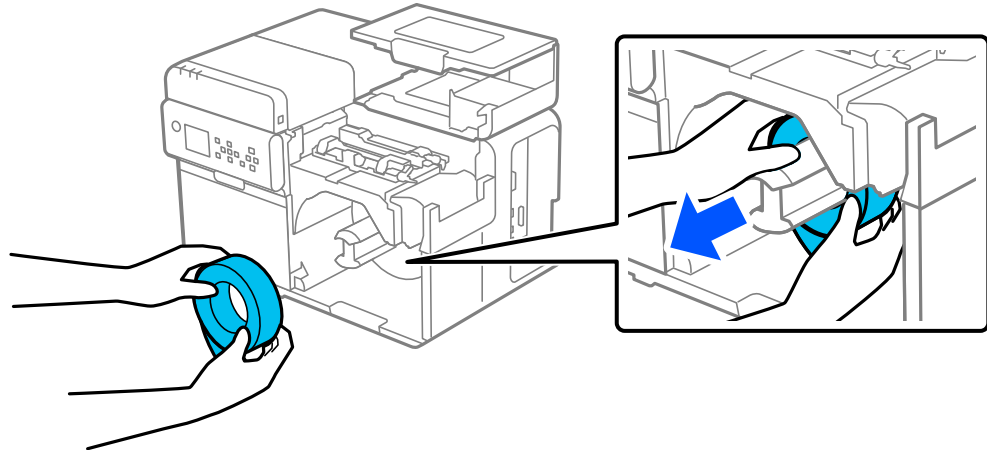

6 Attach the roll paper flange to the spindle.

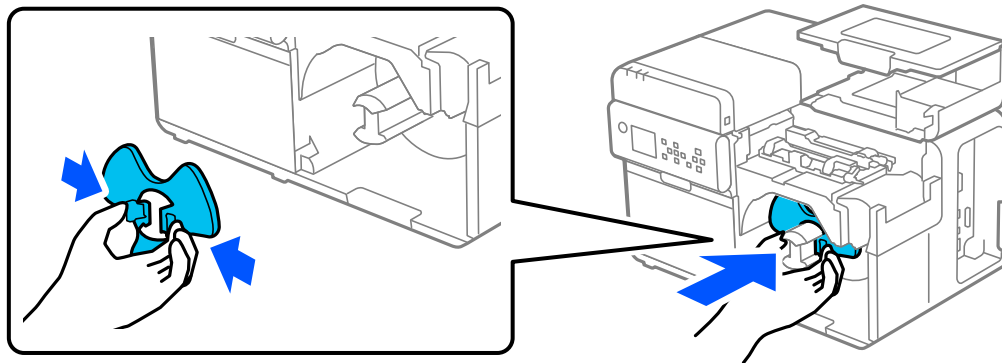

7 Close the paper cover.

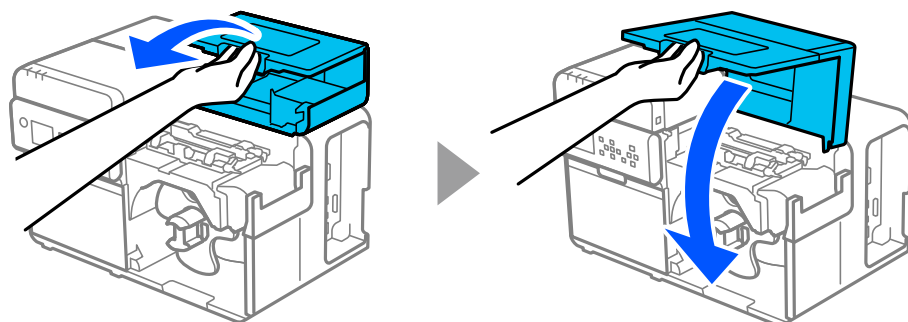

8 Press the **||** (pause) button.

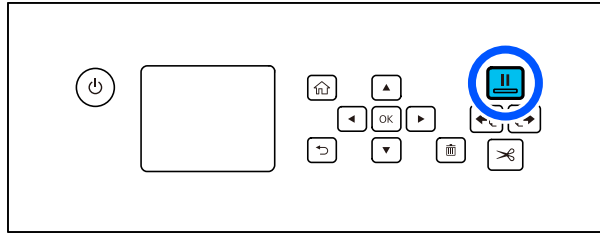

Removing the paper is now completed.

To load paper, see the following pages.

["Loading Roll Paper" on page 67](#), ["Loading Fanfold Paper" on page 72](#)

Replacing the Ink Packs

This section describes how to replace the ink packs.



Carefully read the cautions on handling before installing the ink packs.
 ☞ ["Cautions on Ink Packs" on page 9](#)

Checking Amount of Ink Remaining

You can check approximate remaining amount of ink on the operation panel or a computer.



Even when the printer is low on ink, you can print until you are prompted to replace the ink pack.
 Replace the ink pack as necessary.

How to Replace the Ink Packs



Viewing How to Replace the Ink Packs on the Operation Panel
 ? (Help) – [How To...] – [Ink Pack(s) Replacement]

The procedure below is for replacing the BK ink pack. Follow the same procedure for replacing the other color ink packs.



- When replacing the black ink pack, make sure to replace with a pack of the same type of black ink. The printer does not work if you install a pack of different type of black ink.
- Shake the new ink pack well as instructed before installing it.

1 Open the ink cover.

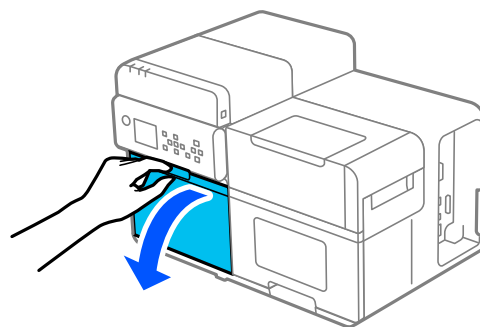

2 Remove the ink pack tray with both hands.



IMPORTANT

Do not grip the ink pack tightly. Ink may leak from the pack.

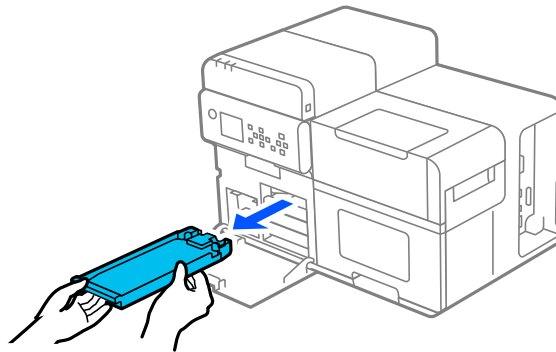

3 Lift the ink pack by the handle and remove it from the tray.

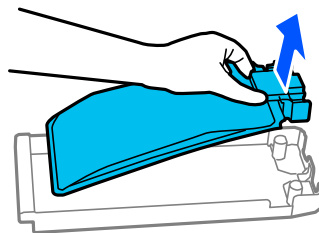

4 Load a new ink pack into the tray.

 ["Cautions on Ink Packs" on page 9](#)



CAUTION

Do not touch the areas shown in the figure.

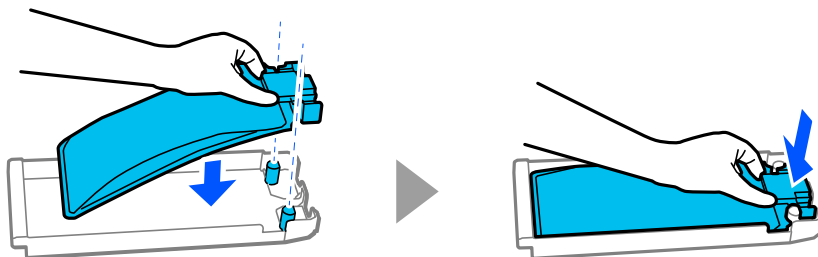
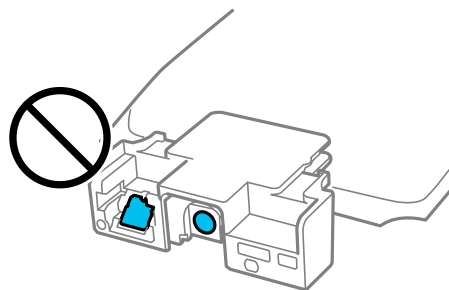

- 5** Hold the ink pack tray with both hands and shake it up and down at an angle of about 60 degrees about 10 times in 10 seconds.

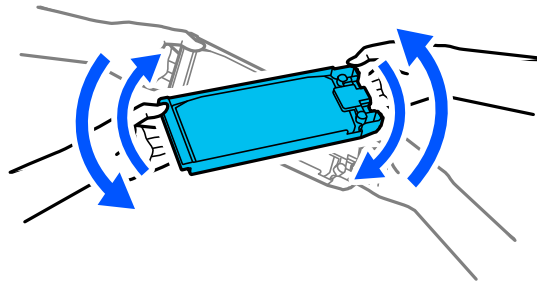

- 6** Make sure the color of the ink pack is the same as the color of the label next to the tray insertion slot, and push the ink pack tray all the way in.



CAUTION

Do not grip the ink pack tightly. Ink may leak from the pack.

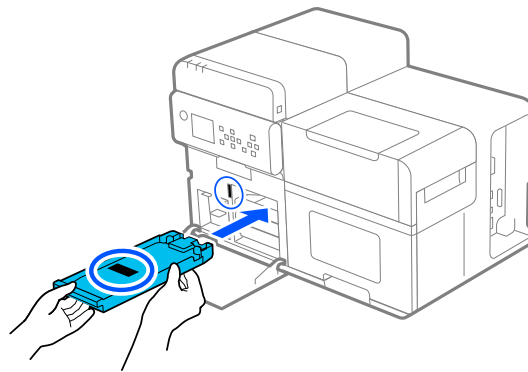

- 7** Close the ink cover.

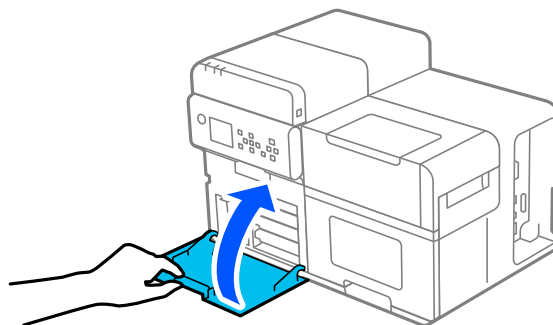

8 Press the **||** (pause) button.

Check that the printer is ready for printing by checking the home screen.

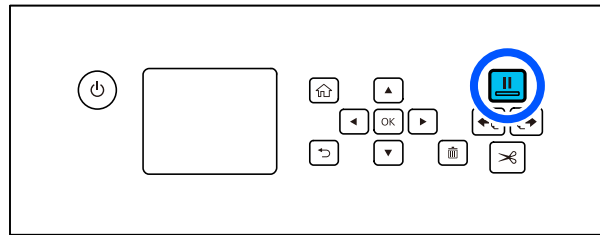

CAUTION

Never open any cover or turn off the printer while the printer is charging ink (while the  (power) LED is flashing). If these operations are performed during ink charging, ink will be severely consumed and the ink pack may need to be replaced before the charging is complete.

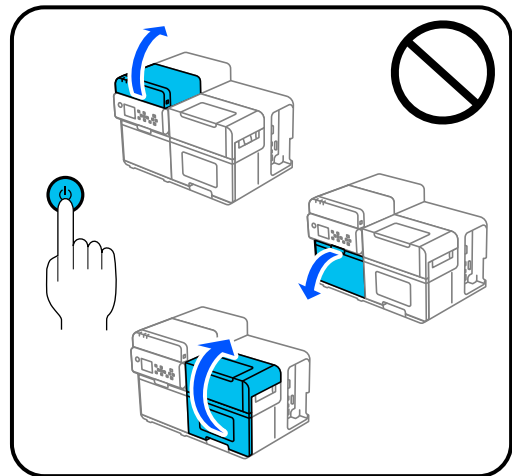
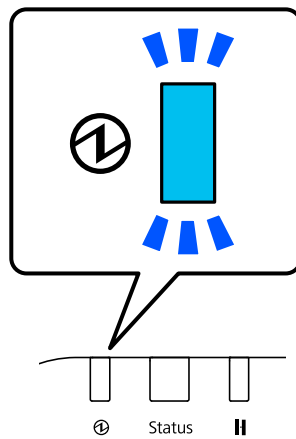

When ink charging is complete, the  (power) LED will change from flashing to lit.

Replacing the Maintenance Box

This section describes how to replace the maintenance box.



Carefully read the cautions on handling before setting the maintenance box.
 ☞ ["Cautions on the Maintenance Box" on page 10](#)

Checking the Amount of Empty Space in the Maintenance Box

You can check approximate amount of empty space in the maintenance box on the operation panel or a computer.



Even if the maintenance box is running low on space, you can still print until you are prompted to replace it. Replace the maintenance box with a new one as necessary.

How to Replace the Maintenance Box



Viewing How to Replace the Maintenance Box on the Operation Panel
 ? (Help) – [How To...] – [Replace Maintenance Box]

1 Open the ink cover.

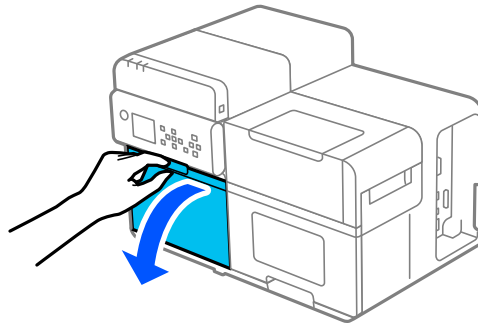

2 Pull out the maintenance box.

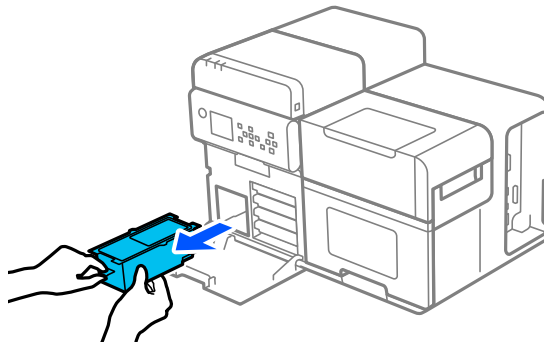

- 3** Seal the used maintenance box in a clear bag and dispose of it.

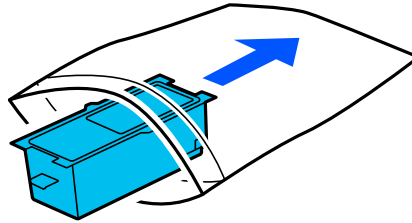

- 4** Take out a new maintenance box from the bag.

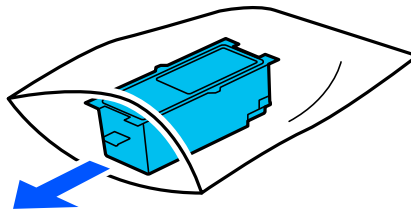
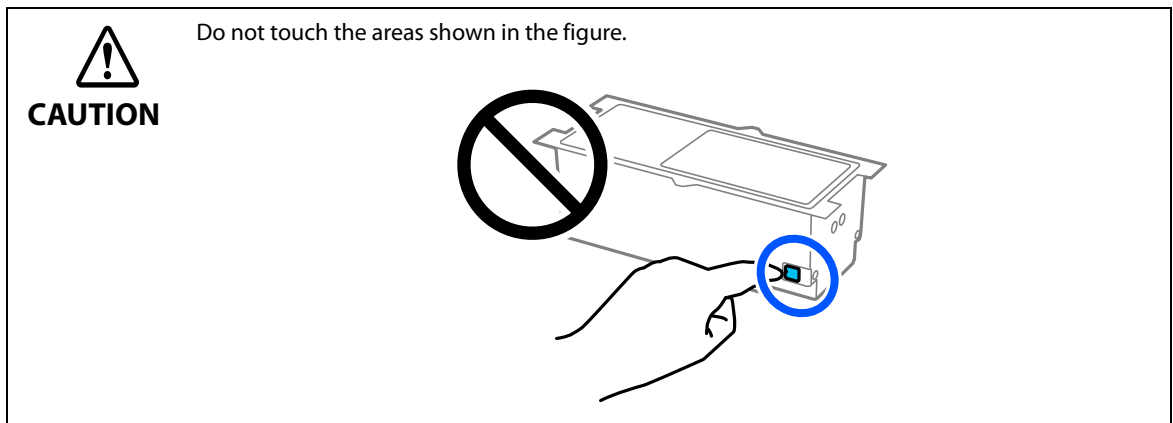

- 5** Press the new maintenance box firmly into the printer with the label side up.

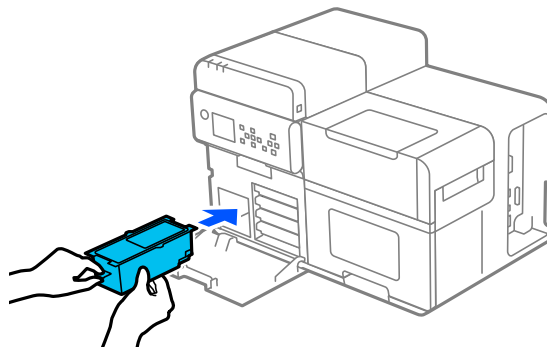

6 Close the ink cover.

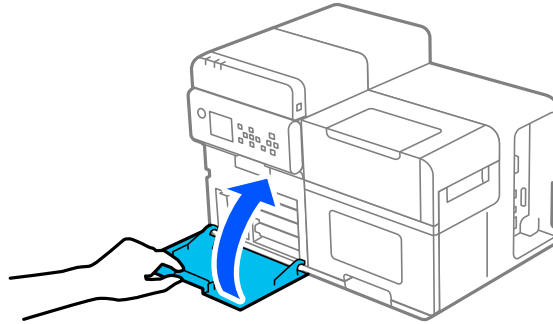

7 Press the || (pause) button.

Check that the printer is ready for printing by checking the home screen.

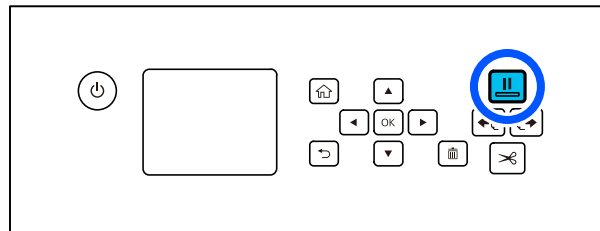

Handling

This chapter provides basic information necessary for handling the printer.

Printer driver for Windows

This chapter describes how to operate the printer driver for Windows.

The printer driver is software to control the printer in accordance with the print instructions of application software. Setting the print settings in the printer driver screen enables you to obtain the best print results. Furthermore, you can also use the utilities to check the printer status and perform maintenance.

How to Display the Printer Driver Screen

The printer driver settings screen can be displayed in one of the following ways.

Method 1: Windows Settings > printer management screen > [Print Settings]

Method 2: Windows Settings > printer management screen > [Printer Properties] > [General Settings] on the [General] tab

Method 3: Windows Settings > printer management screen > [Printer Properties] > [Printing Defaults] on the [Advanced] tab

Method 4: Application software print screen > [Printer Properties]

If you display the driver screen using Method 1 or Method 2 and change the driver settings, the settings are saved as logon user-specific settings.

If you display the driver screen using Method 3 and change the driver settings, the settings will be common to all users of the printer, but the settings of Method 1 or Method 2 will take precedence.

If you display the driver screen using Method 4 and change the driver settings, the settings will be saved only for that moment.

If you want to change the driver's default settings, display the printer driver using Method 1 or Method 2 and then change the settings.

The steps for opening the printer management screen from Windows Settings will vary depending on the version of Windows used.

Printer Driver Screen Configuration

The printer driver is equipped with a help function. Right-click an item and then click Help to display an explanation on the item.

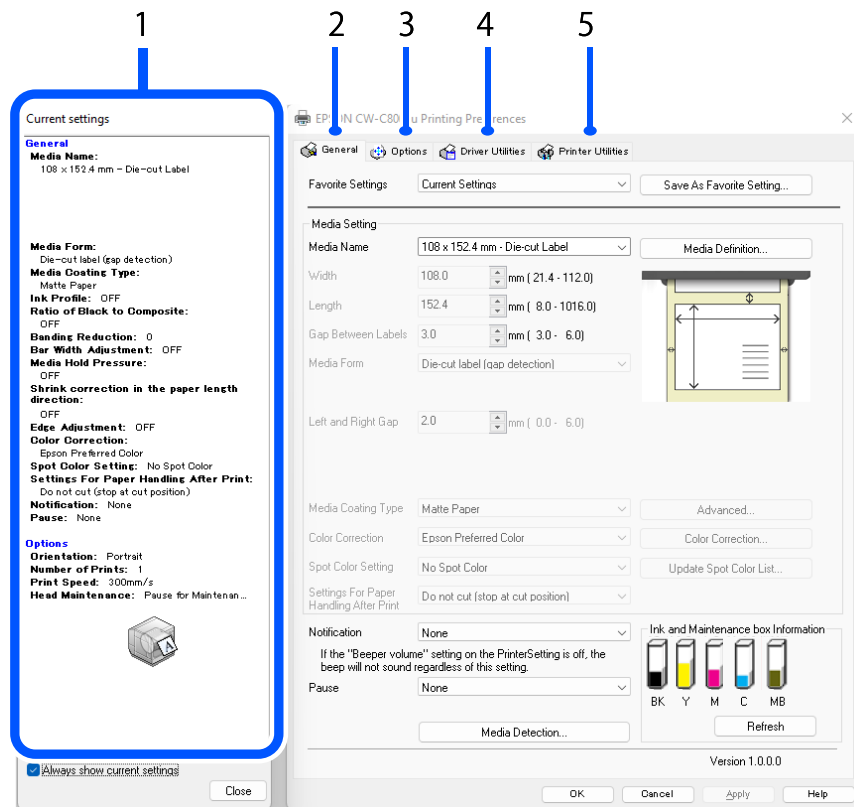

1	Current Settings pane Displays a summary of current settings.
2	General tab Lets you set media (paper) size, media form, and other basic print settings.
3	Options tab Print orientation and the number of copies can be set.
4	Driver Utilities tab Lets you configure various advanced settings.
5	Printer Utilities tab Lets you run printer maintenance functions such as print head cleaning or nozzle check, and start PrinterSetting.

Media (Paper) Settings

This section describes the paper settings of the printer driver.

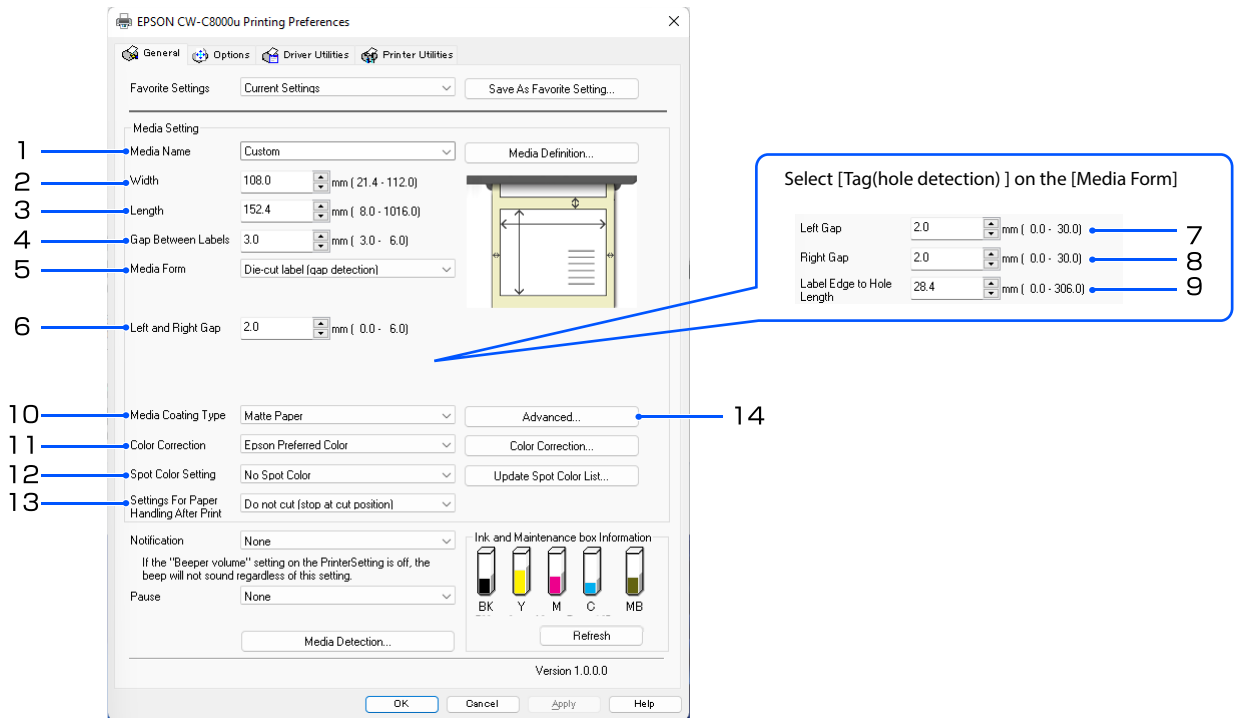

1 Media Name

You can select the media settings you created and registered to [Media Definition]. You can also directly change the paper settings by selecting [Custom].

2 Width

Enter the width.

- Continuous paper or tag: Paper width

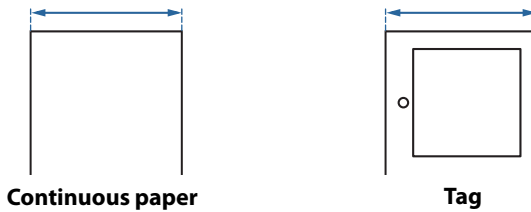

- Die-cut label, Full-page label: Label width excluding the backing paper

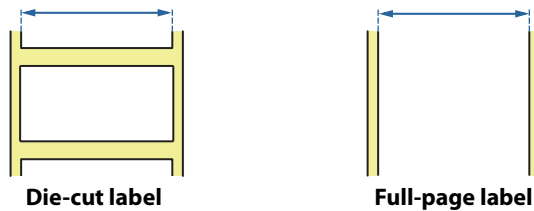

3 Length

Enter the length.

- Continuous paper, full-page label, or tag: Length of the print range (length of one page)

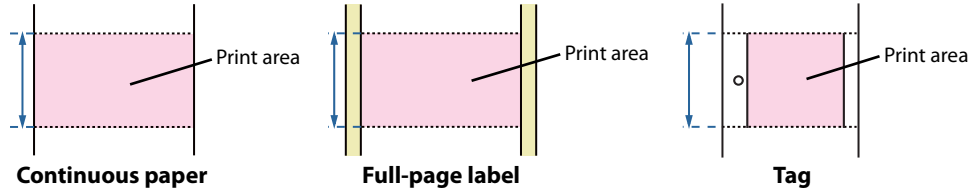

- Die-cut label: Label length excluding backing paper

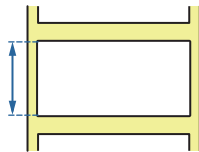

4 Gap Between Labels

Enter the gap between labels.

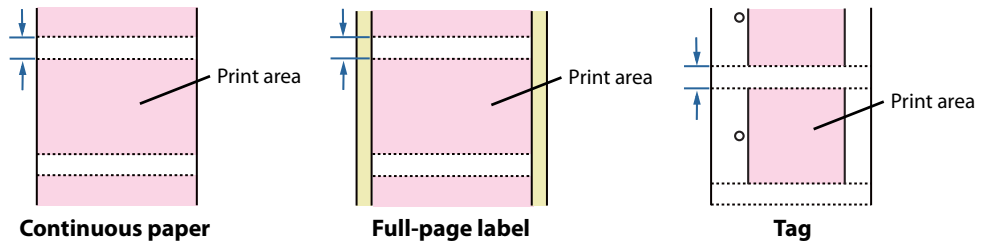

5 Media Form

Select the form of the paper.

- Die-cut label
- Full-page label
- Continuous paper
- Tag

6 Left and Right Gap (for die-cut label, full-page label, and continuous paper)

The left and right gaps are always the same. Therefore, enter one setting value as the [Left and Right Gap].

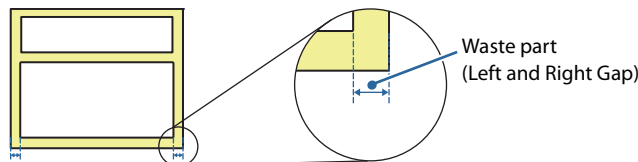

IMPORTANT

- It is recommended to set the [Left and Right Gap] to at least 2 mm {0.08 in.}. Setting it to less than 2 mm {0.08 in.} may cause ink to adhere to the inside of the printer and stain printed paper.
- Regarding the waste part on the left and right of the label
 - Can be set in the range of 0 to 6 mm {0 to 0.24 in.}. (Basically, 2 mm {0.08 in.})
 - If the size is larger than 2 mm {0.08 in.}, paper jams or other problems may occur.

7 Left Gap (for tag)

Enter the left margin (gap) of the paper.

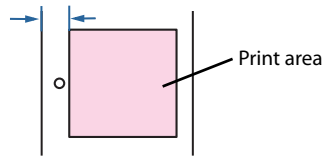
**IMPORTANT**

It is recommended to set the [Left Gap] to at least 2 mm {0.08 in.}. Setting it to less than 2 mm {0.08 in.} may cause ink to adhere to the inside of the printer and stain printed paper.

8 Right Gap (for tag)

Enter the right margin (gap) of the paper.

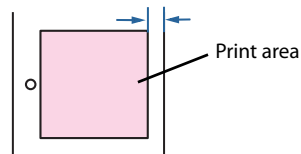
**IMPORTANT**

It is recommended to set the [Right Gap] to at least 2 mm {0.08 in.}. Setting it to less than 2 mm {0.08 in.} may cause ink to adhere to the inside of the printer and stain printed paper.

9 Label Edge to Hole Length (for tag)

The [Tag Hole Detection] setting allows the printer to detect the paper based on holes, oblong holes, or cutouts in the paper.

Set the distance from the top edge of the hole, oblong hole, or cutout to the edge of the paper. ("[Paper Specifications](#)" on page 370)

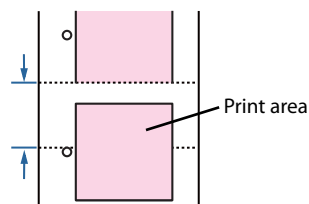
**10 Media Coating Type**

Select the paper type. ("[Paper Specifications](#)" on page 370)

11	Color Correction Mode
-----------	------------------------------

Configure color correction settings. For more details about the color correction, see ["Color Correction" on page 273](#).

- **Epson Preferred Color**
The color correction engine in the printer corrects colors to produce print results that are close to those seen on a typical LCD monitor. The colors are similar to Epson Standard colors, but differ in that CMY ink colors can be printed as they are.
- **Epson Standard**
The color correction engine in the printer corrects colors to produce print results that are close to those seen on a typical LCD monitor.
- **Epson Vivid Color**
The color correction engine in the printer corrects the color to a vivid shade suitable for labels. The color tones are different from those of typical LCD monitors.
- **ICM**
The color correction engine in the OS corrects color tints according to the ICC profile corresponding to the currently set paper type and print speed. With the appropriate ICC profile, the tint on the LCD monitor can be matched to the tint of the printed result.
- **No Color Adjustment**
Select this setting if your application software performs color correction. The printer does not perform color correction.

12	Spot Color Setting
-----------	---------------------------

This function allows you to change a specific color to a specified color. For more details about the spot color setting, see ["Spot Color Settings" on page 267](#).

13	Settings For Paper Handling After Print
-----------	--

- Cut (after printing last label)
- Cut (at specified label)
- Cut (after last page of collate page)
- Do not cut (stop at cut position) (Initial setting)
- Do not cut (stop at specified position)

14	Advanced
-----------	-----------------

You can change the [Print Color Adjustment], [Barcode and 2D Symbol Preset], [Paper Adjustment], and [Edge Adjustment] settings. For explanation of each setting, refer to the Help.

- **Print Color Adjustment**
Ink Profile: Print density can be changed to darker or lighter.
Ratio of Black to Composite: Adjust the ratio of black ink to composite black.
- **Banding Reduction**: If color banding occurs, adjust the ink density.
- **Barcode and 2D Symbol Preset**
Bar Width Adjustment: When using a built-in barcode font, adjust the bar width.
- **Paper Adjustment**
Media Hold Pressure: Adjust the paper suction power of the platen.
Shrink correction in the paper length direction: If the print result shrinks in the paper length direction, set the correction value.



- If the paper type is high glossy paper or glossy film, the [Banding Reduction] function may not be able to reduce color banding so much. Please examine print quality with the paper well before using it.
- The length of the print data is increased up to 1016 mm {40.00 in.} in the paper length direction according to the correction value set in [Shrink correction in the paper length direction]. If the paper length exceeds 1004 mm {39.92 in.}, the correction result will not follow the correction value and a length exceeding 1016 mm {40.00 in.} cannot be set.

- Edge Adjustment
If a slight gap occurs between the background color and the text, enabling [Edge Adjustment] may make the gap less noticeable.

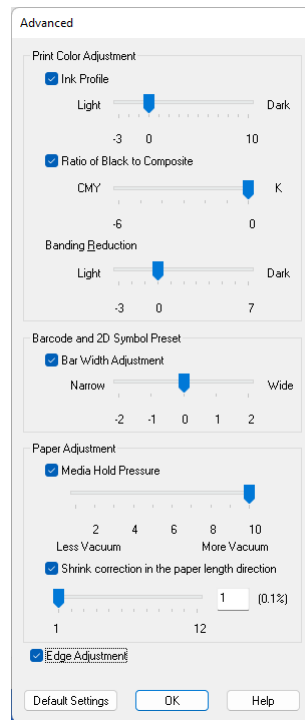

- If you change the settings in [Print Color Adjustment], and/or [Barcode and 2D Symbol Preset], it may affect readability of barcodes.
- If you increase the ratio of black ink in [Ratio of Black to Composite], be careful not to touch the printed surface immediately after printing because ink can adhere to your fingers.

User-Defined Paper

The size, form, type, and other settings of frequently used paper can be registered to the printer driver as a media definition. This is convenient because you will not need to set the paper settings of the driver when printing from an application if you register a media definition in advance.



If you wish to set the paper size and other settings every time without registering a media definition, select [Custom] from the [Media Name] pull-down menu on the [General] tab. The various settings on the [General] tab will become available so that you can set the paper size and other settings.

Registering New

Register a new media definition by following the steps below.

- 1 Open the printer driver window.
- 2 Click the [Media Definition] button on the [General] tab.
The Media Definition screen appears.

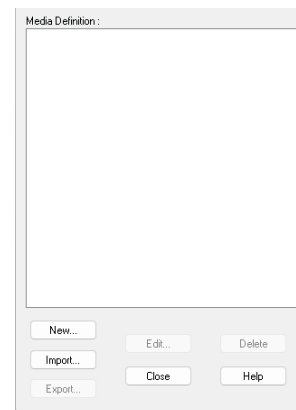
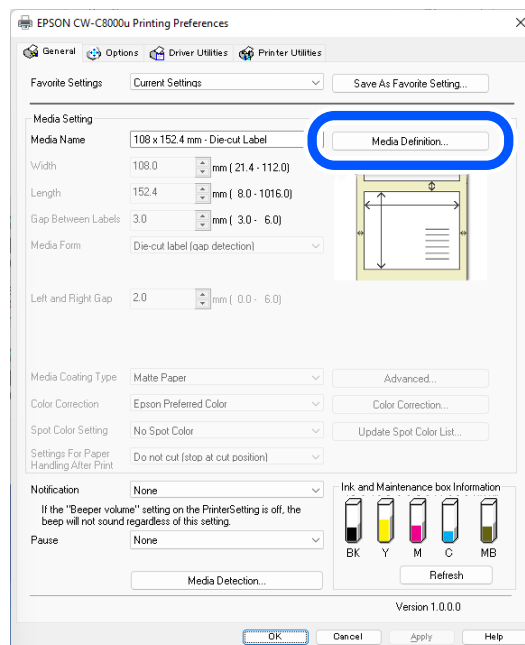

- 3** Click the [New] button.
The New screen appears.

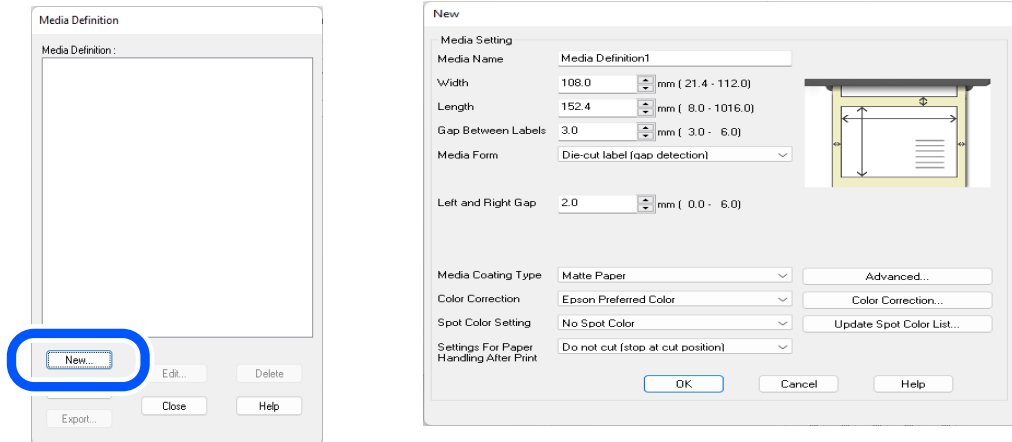

- 4** Enter or change the settings to match them with the paper you use.
Enter the name of the paper definition in [Media Name]. This is the name displayed when you select a paper size from an application. For explanation for the other settings, see "[Media \(Paper\) Settings \(p93\)](#)".

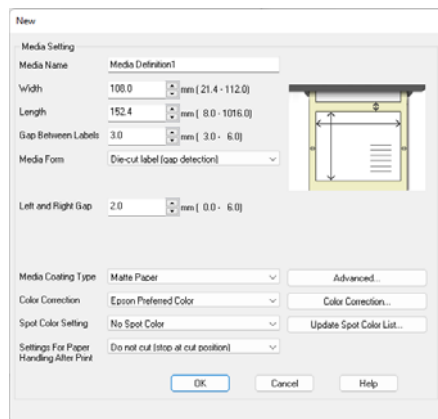

- 5** Click [OK].

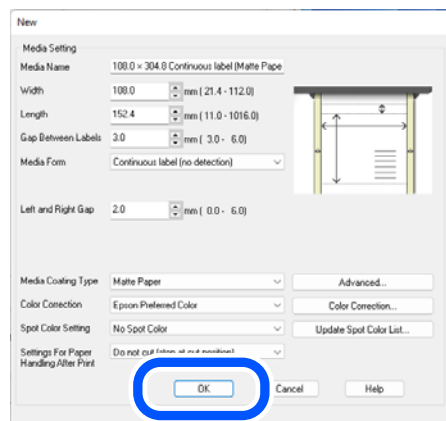

- 6** Check that the registered media name is displayed in the Media Definition screen and then click [Close].

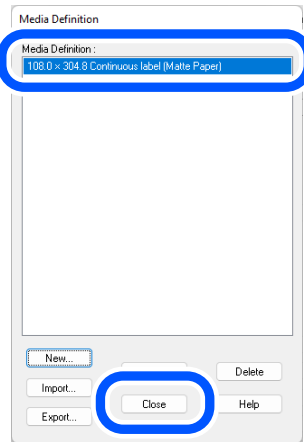

- 7** Check that you can select the registered media name in [Media Name] on the [General] tab.

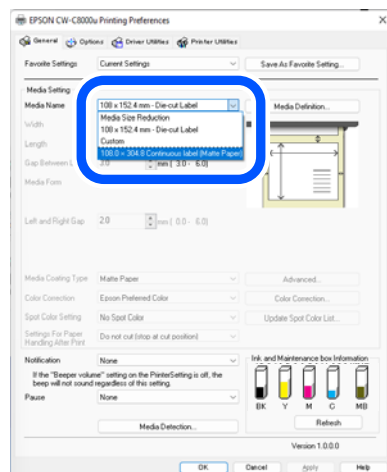

- 8** Click the [OK] button to close the driver.

Paper registration (media definition) is now complete.

Editing and Deleting

- 1 Open the printer driver window.
- 2 Click the [Media Definition] button on the [General] tab.
The Media Definition screen appears.

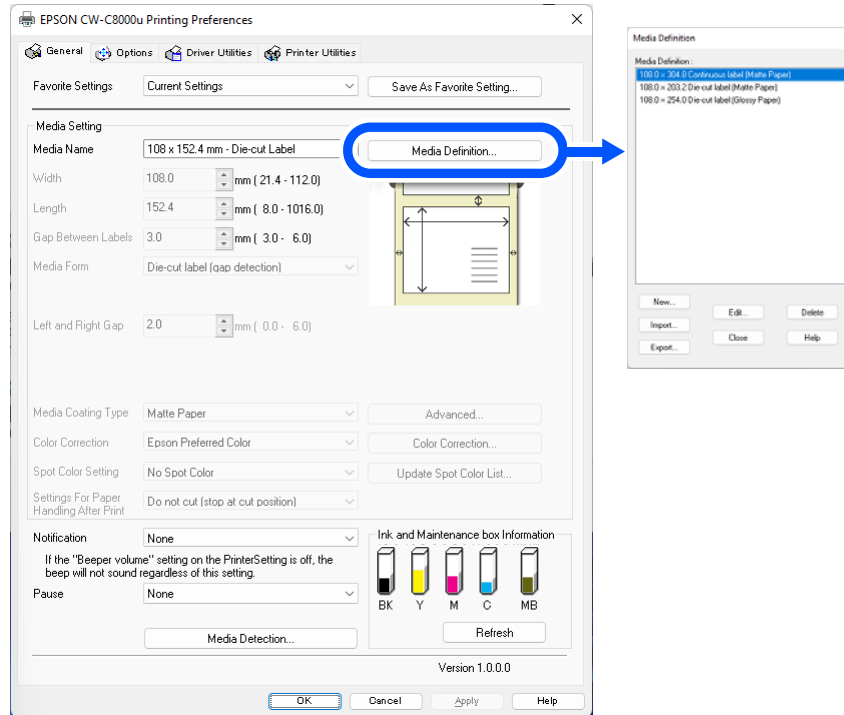

- 3 Click to select the media definition you wish to edit or delete.

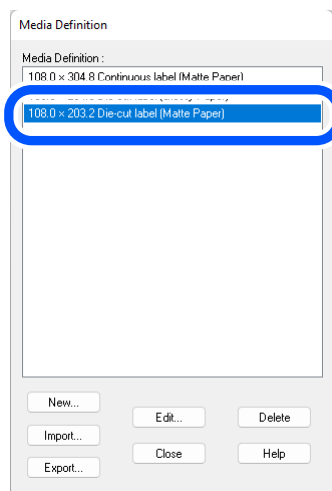

- 4** If you wish to change the definition settings, click the [Edit] button. The Edit screen appears and you can change the definition.

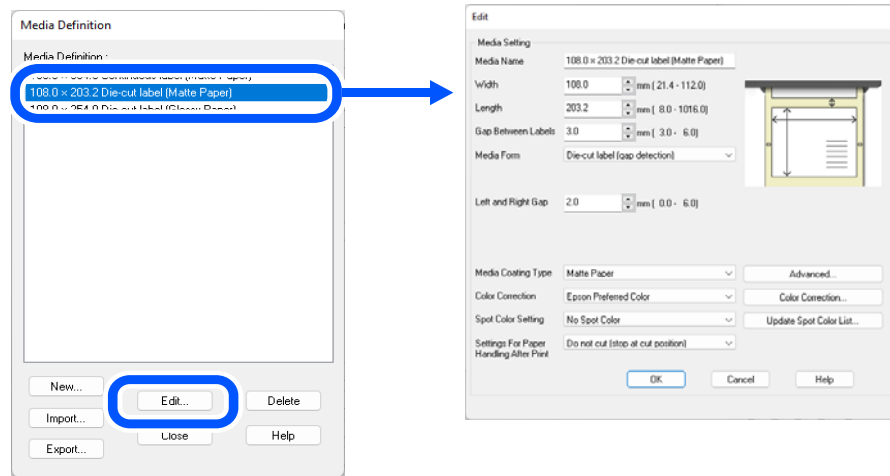

If you wish to delete the definition, click the [Delete] button. A screen appears and if you click the [OK] button, the definition is deleted.

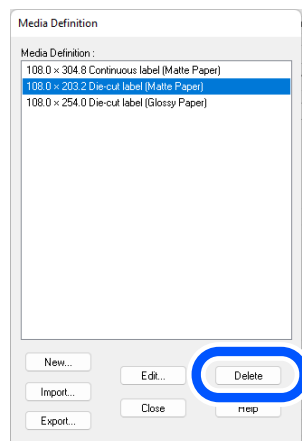

Editing or deleting a media definition is now complete.

Paper Source and Paper Detection Settings

- 1 Open the printer driver window.
- 2 Click [Media Detection...] on the General tab.

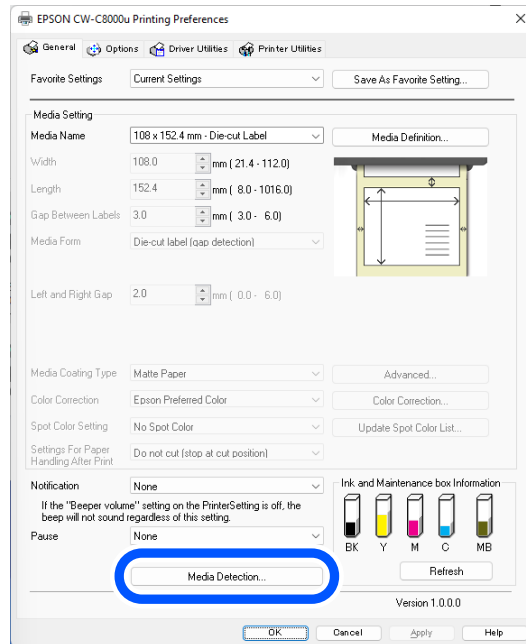

- 3 Make the following settings to match them with the paper you use.

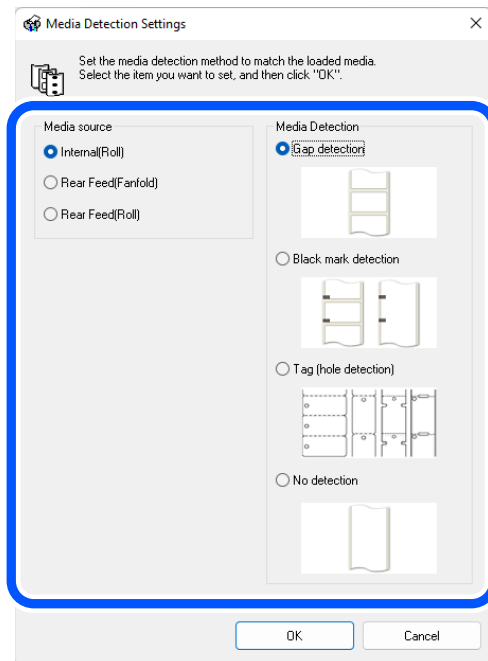

- Media Source: Select how to supply paper to the printer.

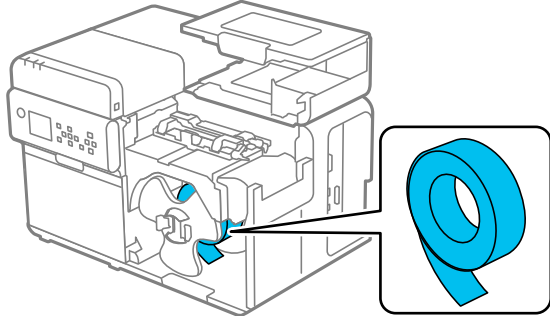
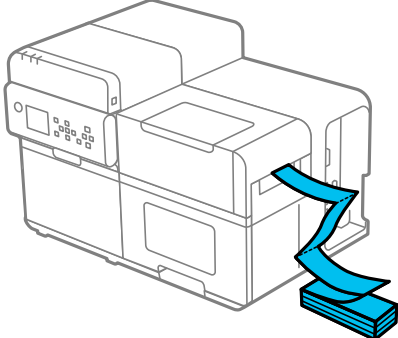
Setting item	Description
Internal (Roll) 	Load a roll of paper inside the printer to let the printer feed paper from inside.
Rear Feed (Fanfold) Rear Feed (Roll) 	Place a roll or fanfold paper beside the printer to let the printer feed paper from outside.



To supply roll paper from outside the printer, prepare an external paper feeder and paper rewinder by yourself. For more details, contact qualified service personnel for advice.

- Media Detection: Select how to detect print positions.

Setting item	Description
Gap detection	The print position is detected based on the gaps between labels.
Black mark detection	The print position is detected based on the black marks printed on the back or backing paper of the paper.
Tag (hole detection)	The print position is detected based on holes, oblong holes, and cutouts in the paper.
No detection	Print position detection using gaps or black marks is not performed.

4

Click [OK].

Paper source and paper detection settings are now complete.

Favorite Settings

The Favorite Settings function allows you to register and manage print settings of the printer driver.



Note that this function is completely different from the [Favorite Setting] available from the operation panel of the printer, and they are not compatible with each other.

The print settings include the settings available on the [General] and [Options] windows. Various settings such as paper type, paper layout, user-defined paper settings are included in the print settings.

[General] window

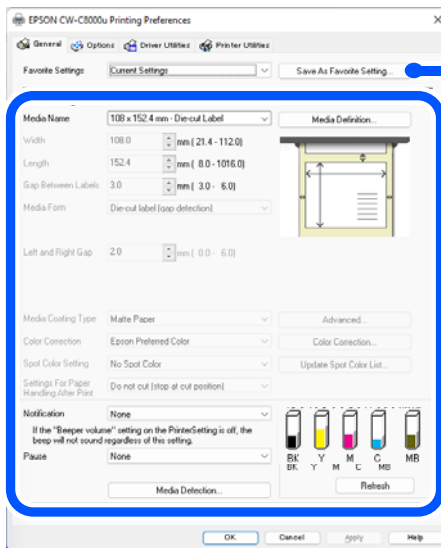

Favorite Settings

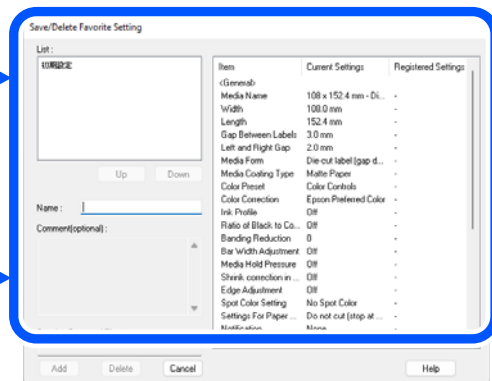

[Options] window

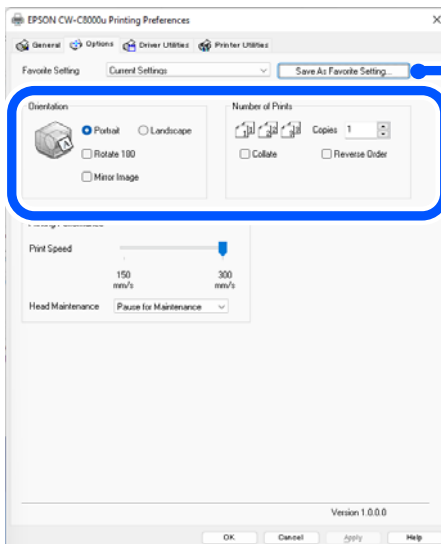

Features

Many sets of print settings can be registered in [Favorite Settings].

If you frequently use multiple sets of print settings due to use of different sizes or types of paper or other reasons, register each set of the print settings to [Favorite Settings] so that you can complete print settings just by selecting the set from the [Favorite Settings] list. This also allows you to prevent misprint due to wrong print settings.

(If you change paper type or size, you may need to change the [Media Detect] setting of the printer.)

Registering Print Settings in [Favorite Settings]

1 Make the print settings to match them with the paper you use.

Configure the print settings on the [General] and [Options] windows. When using a user-defined paper, select it from the [Media Name] list on the [General] window.

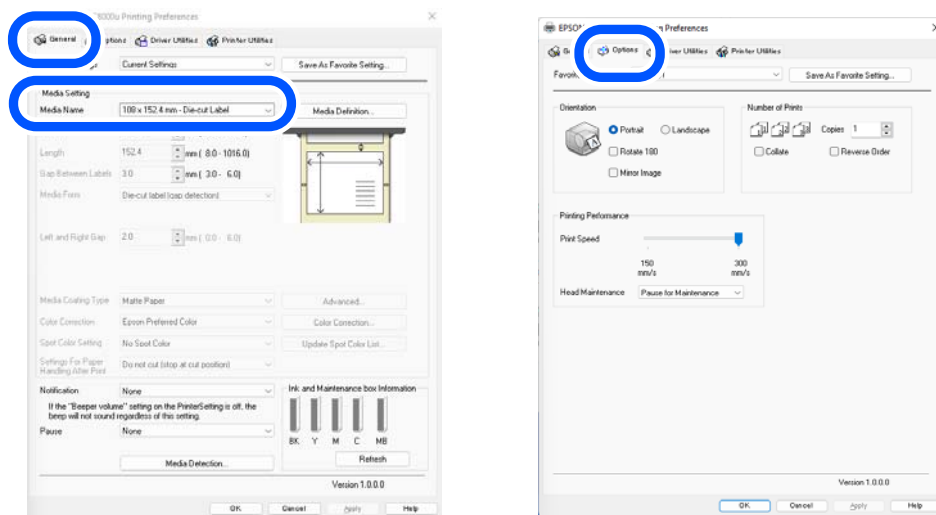

2 Click [Save as Favorite Setting]. The Save/Delete Favorite Setting screen appears.

The current settings are displayed on the right side of the screen.

3 Enter a name of the settings in the [Name] field, and then click [Add].

The Save/Delete Favorite Setting screen is closed.

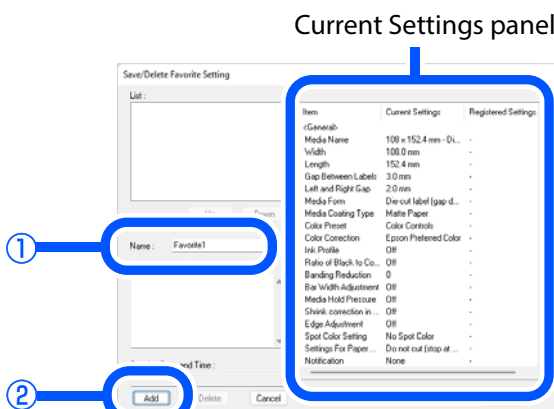

4 Check that the name of the added print settings is displayed in the list of [Favorite Settings].

Registered in [Favorites Settings]

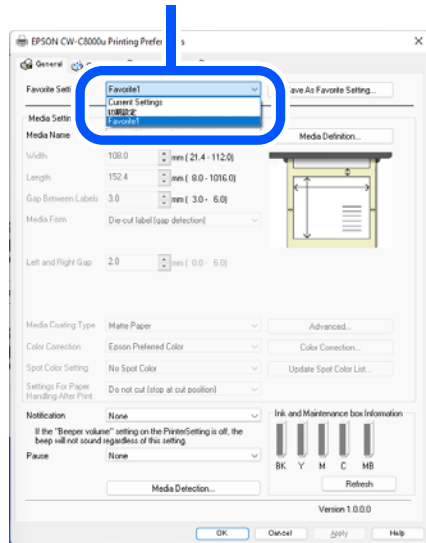

The [Favorite Settings] includes the following settings.

- Default Settings: The printer driver has these settings by default.
- Current Settings: The settings currently configured on the [General] and [Options] windows. You can check the settings on the [Show Settings] screen and on the [Save/Delete Favorite Setting] screen.
- Registered Settings: Print settings registered by the user.

Printing Barcodes

The printer has built-in fonts. This allows you to print a barcode without creating it on an application software.

Barcode Font Settings

You can make the barcode settings using [Barcode and 2D Symbol Settings] on the [Driver Utilities] tab.

1 Make the following settings.

- Display: Select [Barcodes].
- Font Name: Enter a character string. The string is set as the barcode font name. Only ASCII characters are accepted.
- Type: Select a barcode type. Available setting items changes according to the selected barcode type. You can select the type from the following options.

UPC-A	UPC-E	JAN13(EAN)
JAN8(EAN)	Code39	ITF
Codabar	Code93	Code128
GS1-128	GS1 DataBar Omnidirectional	GS1 DataBar Truncated
GS1 DataBar Limited	GS1 DataBar Expanded	

- **Rotation Settings:** Select an option to rotate a barcode.
- **Hexadecimal Input Mode:** Select the check box to enter data for a barcode in hexadecimal.
- **Module:** Specify the width of the narrowest element of the barcode in units of dot.
- **Bar Height:** Specify the height of the element in units of dot. Actual print size equivalent to the specified dots will be displayed.
- **HRI Character Position:** Specify the position to print HRI characters. Select [Do Not Print] if printing HRI characters is not necessary.



Depending on the selected barcode type, the position option cannot be selected.

- **Composite Component:** Select a composite type.
- **Element Ratio:** Specify the ratio of wide element width to the narrowest element width. The recommended ratio is 2.5.
- **Check Digit:** A number or symbol added to the barcode number in order to detect an error in the barcode number and to prevent fabrication.
- **Auto Convert to Minimize Entire Symbol Width:**
You can select this when the barcode type is CODE128. This function minimizes the number of symbols and characters that are necessary to express the specified data string.
- **Start Character:** Specify the start character.
- **Stop Character:** Specify the stop character.
- **Margin Settings:** The background of the barcode is transparent. If you select the checkbox for “Margin Settings”, the barcode is printed with the transparent background filled in white.
The amount of margin can be set for [Top Margin], [Left Margin], [Bottom Margin], and [Right Margin] respectively.

2 Click [Add].

The configured barcode font is registered and added to the font list.



- Up to 30 barcode fonts can be registered.
- To edit settings of a registered barcode font, select the font from the font list, change the settings and then click [Save].
- To delete a registered barcode font, select the font from the font list, and then click [Delete].

Recommended Module Values

Print directions of a barcode are as shown below. The recommended module values vary by paper type, barcode type, and the print direction.

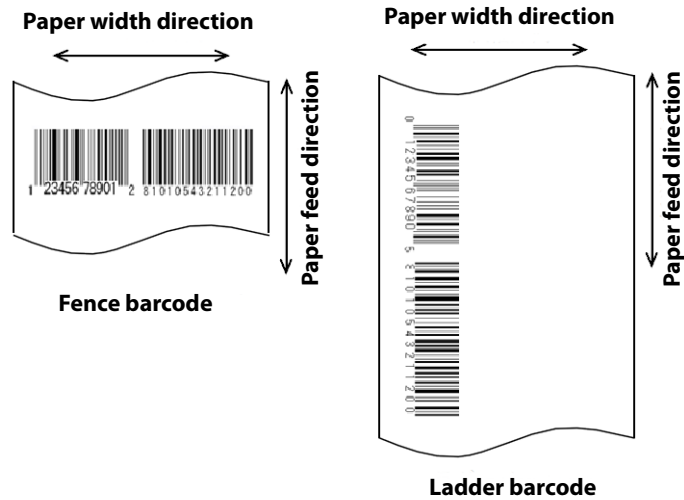

CAUTION

If [Rotation Settings] is set to [Normal] or [Rotate 270 Degrees], the barcode will not be printed.

For ANSI Grade C or higher (minimum module size is 600 dpi) [Page 111](#)

For ANSI Grade B or higher (minimum module size is 600 dpi) [Page 112](#)



- Readability of a barcode varies by paper type, performance of a barcode reader, or other factors. Furthermore, drop in print quality due to clogging of print head nozzles or skew of ink drops can cause a barcode to become unreadable. In case it happens, it is recommended to print HRI characters or take other measures.
- Due to characteristic of ink, ink seeped into paper may cause the bars of a barcode to be printed thicker. In such cases, carry out [Bar Width Adjustment] that reduces the bar width by 2 pixels, and increases space width by 2 pixels.
- If the printer is subjected to vibration or shock during transportation or installation, the barcode rank that can be printed may decrease. In this case, [Adjust Uneven Colors] may improve the barcode rank. ("[Adjust Uneven Colors](#)" on page 204)

ANSI Grade C or higher (minimum module size is 600 dpi)

Barcode	Orientation	Plain Paper	Texture Paper	Matte Paper	Synthetic	Glossy Paper	Glossy Film	High Glossy Paper
Code39	Fence	5	5	5	5	5	5	5
	Ladder	6	6	5	5	5	5	5
Codabar	Fence	5	5	5	5	5	5	5
	Ladder	6	6	5	5	5	5	5
Code93	Fence	5	5	5	5	5	5	5
	Ladder	6	6	5	5	5	5	5
Code128	Fence	5	5	5	5	5	5	5
	Ladder	6	6	5	5	5	5	5
GS1-128	Fence	5	5	5	5	5	5	5
	Ladder	6	6	5	5	5	5	5
ITF	Fence	6	6	6	6	6	6	6
	Ladder	6	6	6	6	6	6	6
GS1 DataBar Omnidirectional	Fence	6	6	6	6	6	6	6
	Ladder	6	6	6	6	6	6	6
GS1 DataBar Truncated	Fence	6	6	6	6	6	6	6
	Ladder	6	6	6	6	6	6	6
GS1 DataBar Limited	Fence	6	6	6	6	6	6	6
	Ladder	6	6	6	6	6	6	6
GS1 DataBar Expanded	Fence	6	6	6	6	6	6	6
	Ladder	6	6	6	6	6	6	6
UPC-A	Fence	7	7	7	7	7	7	7
UPC-E	Ladder	7	7	7	7	7	7	7
JAN13	Fence	7	7	7	7	7	7	7
JAN8	Ladder	7	7	7	7	7	7	7
EAN13	Fence	7	7	7	7	7	7	7
EAN8	Ladder	7	7	7	7	7	7	7

ANSI Grade B or higher (minimum module size is 600 dpi)

Barcode	Orientation	Plain Paper	Texture Paper	Matte Paper	Synthetic	Glossy Paper	Glossy Film	High Glossy Paper
Code39	Fence	7	7	6	6	6	6	6
	Ladder	8	8	6	6	6	6	6
Codabar	Fence	6	6	6	6	6	6	6
	Ladder	8	8	6	6	6	6	6
Code93	Fence	7	7	6	6	6	6	6
	Ladder	8	8	6	6	6	6	6
Code128	Fence	6	6	6	6	6	6	6
	Ladder	7	7	6	6	6	6	6
GS1-128	Fence	6	6	6	6	6	6	6
	Ladder	7	7	6	6	6	6	6
ITF	Fence	8	8	7	6	7	7	7
	Ladder	7	7	7	6	7	7	7
GS1 DataBar Omnidirectional	Fence	6	6	6	6	6	6	6
	Ladder	8	8	6	6	6	6	6
GS1 DataBar Truncated	Fence	6	6	6	6	6	6	6
	Ladder	8	8	6	6	6	6	6
GS1 DataBar Limited	Fence	6	6	6	6	6	6	6
	Ladder	8	8	6	6	6	6	6
GS1 DataBar Expanded	Fence	6	6	6	6	6	6	6
	Ladder	8	8	6	6	6	6	6
UPC-A	Fence	7	7	7	7	7	7	7
UPC-E	Ladder	7	7	7	7	7	7	7
JAN13	Fence	7	7	7	7	7	7	7
JAN8	Ladder	7	7	7	7	7	7	7
EAN13	Fence	7	7	7	7	7	7	7
EAN8	Ladder	7	7	7	7	7	7	7

How to Specify Barcode Data

See the following descriptions to specify barcode data.

About the composite symbol:

Switching between CC-A and CC-B is automatically performed, however, to use CC-C, you need to specify to use it.

(For GS1-128, the type of composite component can be selected from [No composite], [CC-A/CC-B], and [CC-C].)

Composite component type	Encodable number of digits
CC-A	1 to 56 digits
CC-B	1 to 338 digits
CC-C	1 to 2361 digits

About HRI characters:

If the length of the HRI characters becomes wider than entire width of the barcode, the length is regarded as the barcode width.

UPC-A

- Specify the barcode data with 11 digits. A check digit will be automatically added.

UPC-E

- Specify the barcode data with 10 digits. 5 digits are for a manufacturer code, and the rest of 5 digits are for a product code.

JAN13(EAN)

- Specify the barcode data with 12 digits. A check digit will be automatically added.

JAN8(EAN)

- Specify the barcode data with 7 digits. A check digit will be automatically added.

Code39

- If both or either one of a start code or a stop code is not specified, they will be automatically added.

ITF

- If specified with an odd number of digits, "0" (zero) will be automatically added at the beginning of the digits.

Codabar(NW7)

- Do not include a start code and a stop code. The start code and stop code you specified on the printer driver will be added.

Code93

- A start code, two check digits, and a stop code will be automatically added.
- A character (□) that indicates a start code is printed at the beginning of the HRI characters.
- A character (□) that indicates a stop code is printed at the end of the HRI characters.
- A combination of ■ and an alphabet character is printed to express each of HRI control characters (00h to 1Fh, 7Fh).

Control character		HRI character	Control character		HRI character	Control character		HRI character
ASCII	Hex number		ASCII	Hex number		ASCII	Hex number	
NULL	00	■ U	VT	0B	■ K	SYN	16	■ V
SOH	01	■ A	FF	0C	■ L	ETB	17	■ W
STX	02	■ B	CR	0D	■ M	CAN	18	■ X
ETX	03	■ C	SO	0E	■ N	EM	19	■ Y
EOT	04	■ D	SI	0F	■ O	SUB	1A	■ Z
ENQ	05	■ E	DLE	10	■ P	ESC	1B	■ A
ACK	06	■ F	DC1	11	■ Q	FS	1C	■ B
BEL	07	■ G	DC2	12	■ R	GS	1D	■ C
BS	08	■ H	DC3	13	■ S	RS	1E	■ D
HT	09	■ I	DC4	14	■ T	US	1F	■ E
LF	0A	■ J	NAK	15	■ U	DEL	7F	■ F

Code128

- If you have disabled the auto convert function, enter a two-digits start code at the beginning of the data. If you have enabled the auto convert function, the type of start character is automatically determined and you do not need to specify the type in your application.
 - An error will occur if you add {A, which sets the type to CODE A, when CODE A has already been selected as the start character.
 - An error will occur if you add {B, which sets the type to CODE B, when CODE B has already been selected as the start character.
 - An error will occur if you add any one of the following characters when CODE C has already been selected as the start character.
 {S {C {2 {3 {4 {{
- A special character is expressed by a combination of { and the next character.

Control character	ASCII	HRI character
SHIFT	{S	Not printed
CODE A	{A	Not printed
CODE B	{B	Not printed
CODE C	{C	Not printed
FNC1	{1	Not printed
FNC2	{2	Not printed
FNC3	{3	Not printed
FNC4	{4	Not printed
{	{{	{ is printed.

GS1-128

- ‘()’ are used as delimiters for the application identifiers. (printed as the HRI character, but not encoded.)
- A start code (CODE A, CODE B, CODE C) and a stop code will be automatically added.
- A symbol character FNC1 is automatically added next to the start code.
- If you use “*”, it will be skipped.
- As an application identifier, specify a two-digits consecutive number. If the identifier is not specified correctly, an error will occur.
- A special character is expressed by a combination of { and the next character.
- If data immediately after { does not apply to any one of the followings, an error will occur.

Control character	ASCII	HRI character
Control character (00h to 1Fh, and 7Fh)		A space is printed.
FNC1	{1	A space is printed.
{	{{	{ is printed.
{({{((is printed.
{)}	{{)}) is printed.
{*}	{{*}	* is printed.
Beginning parenthesis for an application identifier	((is printed.
Closing parenthesis for an application identifier)) is printed.
Skipped character	*	Not printed

GS1 DataBar Omnidirectional / GS1 DataBar Truncated / GS1 DataBar Limited

- The first “01”, an application identifier, is not encoded (not included as the barcode data).
- When the HRI character is printed, the application identifier 01 is printed as “(01)” before the package identification code.
- You do not need to add a check digit in the barcode data.
- When the HRI character is printed, a check digit will be automatically printed after the product code.
- For GS1 DataBar Limited, specify 0 or 1 for the first digit.

GS1 DataBar Expanded

- ‘()’ are used as delimiters for the application identifiers. (printed as the HRI character, but not encoded.)
- Be sure to include all the application identifiers in the data.
- If the first data is “01” when an application identifier, left and right parentheses, and * are excluded, the 14th digit counted from the digit next to “01” is used as the check digit. If the data is incorrect, an error will occur.
- If the number of digits after “01” is less than 14, a check digit is not added.
(Unlike GS1-128, a symbol “*” cannot be used for automatic calculation and addition of a check digit. If “*” is added in the data, it will be ignored and the subsequent data is shifted by one digit.)
- Specify a special character as described below.

Control character	ASCII	HRI character
FNC1	{1	Not printed
Beginning parenthesis for an application identifier	((is printed.
Closing parenthesis for an application identifier)) is printed.
'*'	{*	Error
Skipped character	*	Not printed
'{'	{{	{ is printed.

How to Print

Open print data file in an application, and specify barcode font, point, and language that you have set on the printer driver, and then print it.



- The barcode size cannot be changed from the point set in [Specified Point]. If you specify a size other than the specified one, the barcode is not printed.
- Some application such as .NET application may not be able to display or let you select the barcode font registered by the printer driver. If that occurs, use the [Font Replacement] function of the printer driver to replace a True Type font with the barcode font. See "[Printing Barcodes / 2D Symbols on .NET Environment](#)" on page 126.

Printing 2D Symbols

The printer driver has the built-in 2D symbol font. This allows you to print a 2D symbol without creating it on an application software.

Setting the 2D Symbol Font

You can make the 2D symbol settings using [Barcode and 2D Symbol Settings] on the [Driver Utilities] tab.

1 Make the following settings.

- * Display: Select [2D Symbols].
- * Font Name: Enter a character string. The string is set as the 2D symbol font name. Only ASCII characters are accepted.
- * Type: Select a type of 2D symbol. Available setting items changes according to the selected type.
- * Rotation Settings: Select an option to rotate a 2D symbol.
- * Hexadecimal Input Mode: Select the check box to enter data for a 2D symbol in hexadecimal.
- * Margin Settings: The background of 2D Symbols is transparent. If you select the checkbox for “Margin Settings”, the barcode is printed with the transparent background filled in white.
The amount of margin can be set for [Top Margin], [Left Margin], [Bottom Margin], and [Right Margin] respectively.

2 Make the settings for the barcode type you selected.

- Settings for PDF417
 - * Module Width: Set module width of PDF417.
For the recommended value, see "[Recommended Module Values \(p122\)](#)".
 - * Module Height: Specify the ratio of PDF417 module height to the module width.
For the recommended value, see "[Recommended Module Values \(p122\)](#)".
 - * Column: Specify the number of columns of PDF417.
 - * Row: Specify the number of rows of PDF417.
 - * Truncation Symbol: Select the check box to create a symbol using data excluding the stop code of PDF417.
 - * Error Correction Level: Specify an error correction level for PDF417. This allows the symbol data to be correctly read even if a portion of the symbol is missing or damaged. The larger the number is, the higher the possibility of data restoration gets.
- Settings for MicroPDF417
 - * Module Width: Set module width of MicroPDF417.
For the recommended value, see "[Recommended Module Values \(p122\)](#)".
 - * Module Height: Specify the ratio of MicroPDF417 module height to the module width.
For the recommended value, see "[Recommended Module Values \(p122\)](#)".
 - * Column: Specify the number of columns of MicroPDF417.
 - * Row: Specify the number of rows of MicroPDF417.
- Settings for QR code
 - * Model: Select a QR code model.
 - * Module: Select a width of a cell (module) of QR code.
For the recommended value, see "[Recommended Module Values \(p122\)](#)".
 - * Error Correction Level: Specify an error correction level for QR code. This allows the symbol data to be correctly read even if a portion of the symbol is missing or damaged. The possibility of data restoration gets higher in the order of L, M, Q, and H.
 - * Character Mode: Select a mode for data to be converted into a QR code.
- Settings for Micro QR code
 - * Version: Specify the version of Micro QR code.
 - * Module: Select a width of a cell (module) of Micro QR code.
For the recommended value, see "[Recommended Module Values \(p122\)](#)".
 - * Error Correction Level: Specify an error correction level for Micro QR code. This allows the symbol data to be correctly read even if a portion of the symbol is missing or damaged. The possibility of data restoration gets higher in the order of L, M.
- Settings for MaxiCode
 - * Mode: Select a mode of MaxiCode.
- Settings for GS1 DataBar
 - * Module: Set module width of GS1 DataBar.
For the recommended value, see "[Recommended Module Values \(p122\)](#)".
 - * Number of Characters: Specify the max width of GS1 DataBar.
Set this if you have selected GS1 DataBar Expanded Stacked.

- Settings for AztecCode
 - * Type: Select a type of AztecCode.
 - * Cell Size: Select a size of a cell (module) of AztecCode.
For the recommended value, see "[Recommended Module Values \(p122\)](#)".
 - * Number of Layers: Specify the number of layers of AztecCode.
 - * Error Correction Area: Select any one of the following error correction area settings for AztecCode. This allows the symbol data to be correctly read even if a portion of the symbol is missing or damaged. The larger the number is, the higher the possibility of data restoration gets.
[Auto]: the default is 23%+3 code words.
[Specify a Percentage]: Enter a percentage of error correction area into the entry field.
- Settings for DataMatrix
 - * Symbol Shape: Select a shape of DataMatrix symbol.
 - * Error Correction Level: Specify an error correction level for DataMatrix.
 - * Cell Size: Select a size of a cell (module) of DataMatrix.
For the recommended value, see "[Recommended Module Values \(p122\)](#)".
 - * Number of Vertical Cells: Specify the number of cells of DataMatrix in the vertical direction.
Set this when you have selected [Rectangle] in the DataMatrix [Symbol Shape] setting.
 - * Number of Horizontal Cells: Specify the number of cells of DataMatrix in the horizontal direction.
Set this when you have selected [Rectangle] in the DataMatrix [Symbol Shape] setting.
[Minimize]: The number of cells is automatically optimized and minimized.
[Specify the Size]: The number of cells is set according to the selected size.

3 Click [Add].

The configured 2D symbol font is registered and added to the font list.



- Up to 30 2D symbol fonts can be registered.
- To edit settings of a registered 2D symbol font, select the font from the font list, change the settings and then click [Save].
- To delete a registered 2D symbol font, select the font from the font list, and then click [Delete].

Recommended Module Values

The recommended module values vary by paper type, 2D symbol type, and the print direction.



- You cannot change the orientation of a QR code, Micro QR code, and Maxi code by setting [Orientation] on the [Options] tab to [Landscape].
- You cannot rotate a QR code, Micro QR code, and Maxi code by selecting [Rotate 180] on the [Options] tab. In addition, if [Rotation Settings] is set to [Normal] or [Rotate 270 Degrees], 2D symbol is not printed.

2D Symbols - Stacked code type

- For ANSI Grade C or higher (minimum module size is 600 dpi)

Stacked 2D Symbols	Orientation	Plain Paper	Texture Paper	Matte Paper	Synthetic	Glossy Paper	Glossy Film	High Glossy Paper
PDF417	-	5	5	5	5	5	5	5
Micro PDF	-	5	5	5	5	5	5	5
GS1 DataBar Stacked	-	5	5	5	5	5	5	5
GS1 DataBar Stacked Omnidirectional	-	5	5	5	5	5	5	5
GS1 DataBar Expanded Stacked	-	5	5	5	5	5	5	5

- For ANSI Grade B or higher (minimum module size is 600 dpi)

Stacked 2D Symbols	Orientation	Plain Paper	Texture Paper	Matte Paper	Synthetic	Glossy Paper	Glossy Film	High Glossy Paper
PDF417	-	5	5	5	5	5	5	5
Micro PDF	-	6	6	5	5	5	5	5
GS1 DataBar Stacked	-	5	5	6	5	6	6	6
GS1 DataBar Stacked Omnidirectional	-	5	5	6	5	6	6	6
GS1 DataBar Expanded Stacked	-	5	5	6	5	6	6	6



- If the printer is subjected to vibration or shock during transportation or installation, the barcode rank that can be printed may decrease. In this case, [Adjust Uneven Colors] may improve the barcode rank. ("[Adjust Uneven Colors](#)" on page 204)

2D Symbols - Matrix code type

☐ For ANSI Grade C or higher (minimum module size is 600 dpi)

Stacked 2D Symbols	Orientation	Plain Paper	Texture Paper	Matte Paper	Synthetic	Glossy Paper	Glossy Film	High Glossy Paper
QR Code	-	10	10	9	10	9	9	9
Micro QR	-	12	12	11	12	11	11	11
Aztec	-	8	8	8	8	8	8	8
DataMatrix	-	9	9	7	8	7	7	7
MaxiCode	-	21	21	21	21	21	21	21

☐ For ANSI Grade B or higher (minimum module size is 600 dpi)

Stacked 2D Symbols	Orientation	Plain Paper	Texture Paper	Matte Paper	Synthetic	Glossy Paper	Glossy Film	High Glossy Paper
QR Code	-	12	12	11	11	11	11	11
Micro QR	-	12	12	12	12	12	12	12
Aztec	-	9	9	9	9	9	9	9
DataMatrix	-	10	10	9	9	9	9	9
MaxiCode	-	21	21	21	21	21	21	21



- If the printer is subjected to vibration or shock during transportation or installation, the barcode rank that can be printed may decrease. In this case, [Adjust Uneven Colors] may improve the barcode rank. ("[Adjust Uneven Colors](#)" on page 204)

Specifying Data of 2D Symbols

See the following descriptions to specify 2D symbol data.

PDF417 / MicroPDF417

- If the number of columns and rows is 0, they are automatically calculated.
- When specifying a number other than 0, specify the numbers so that multiplying the columns by the rows equals 928 or lower.

QR Code

- According to the data size, the version is automatically changed to the version appropriate to the size.

Micro QR Code

- The size is automatically determined.

MaxiCode

- Specify a special character as described below.

Control character	Hexadecimal
SHIFT	0x7B, 0x53
CODE B	0x7B, 0x42
CODE C	0x7B, 0x43
FNC1	0x7B, 0x31
FNC2	0x7B, 0x32
FNC3	0x7B, 0x33
FNC4	0x7B, 0x34

DataMatrix

- If data immediately after { does not apply to any one of the followings, an error will occur.

Control character	ASCII
FNC1	{1
{	{{

GS1 DataBar Stacked / GS1 DataBar Stacked Omnidirectional

- Do not include the application identifier “01” in the beginning of data.
- You do not need to add a check digit in the data.
- Printing the 2D symbol with a composite symbol is supported. When printing the 2D symbol with a composite symbol, use “\|” or “|\
” to separate the barcode data from the data for the composite symbol. First enter data for the composite symbol, then enter data for the 2D symbol.

GS1 DataBar Expanded Stacked

- Multiple GS1 DataBar Expanded barcodes can be stacked. The way to specify the data is the same with that for GS1 DataBar Expanded. For details, see "[GS1 DataBar Expanded \(p117\)](#)".
- Printing the 2D symbol with a composite symbol is supported. When printing the 2D symbol with a composite symbol, use “\|” or “|\” to separate the barcode data from the data for the composite symbol. First enter data for the composite symbol, then enter data for the 2D symbol.

AztecCode

- Both the full range mode and the compact mode are supported.

How to Print

Open print data file in an application, and specify 2D symbol font, point, and language that you have set on the printer driver, and then print it.



- The 2D symbol font size cannot be changed from the point set in [Specified Point]. If you specify a size other than the specified one, the 2D symbol is not printed.
- Some application such as .NET application may not be able to display or let you select the 2D symbol font registered by the printer driver. If that occurs, use the [Font Replacement] function of the printer driver to replace a True Type font with the 2D symbol font. See "[Printing Barcodes / 2D Symbols on .NET Environment](#)" on page 126.

Printing Barcodes / 2D Symbols on .NET Environment

Since .NET Framework supports only True Type fonts and Open Type fonts, barcode or 2D symbol fonts registered in the printer driver cannot be printed. To solve the problem, use the [Font Replacement] function of the printer driver to replace a True Type font with the barcode or 2D symbol font. Then you can print the barcode or 2D symbol fonts from an application on .NET Framework environment.

On the application, font name of the replaced True Type font is displayed, however, when the data is printed, the barcode or 2D symbol is printed.

Font Replacement

To set font replacement, open the printer driver, select [Driver Utilities] tab, and then select [Font Replacement].

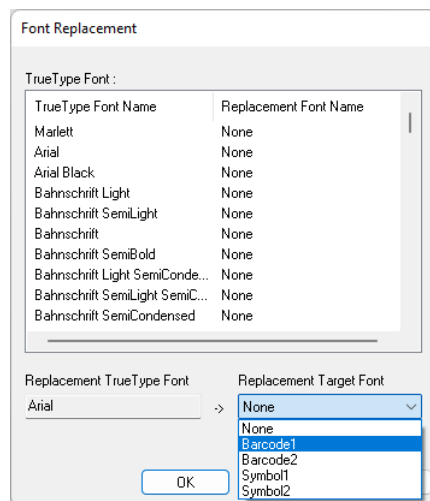

1 Make the following settings.

- Replacement True Type Font
 - * Select a True Type font you want to substitute.
- Replacement Target Font
 - * Select a barcode or 2D symbol font you want to use.

2 Click [OK].

The True Type font is replaced with the barcode or 2D symbol font.

Printing Barcodes/2D Symbols

In the print data file, specify the True Type font that you replaced with the barcode or 2D symbol font, and specify the point and language.



- The point of barcode or 2D symbol is predetermined. Check the point in the [Barcode and 2D Symbol Settings] on the [Driver Utilities] window. If you specify a value other than the specified one, the barcode or 2D symbol is not printed.
- You cannot use the replaced True Type font for data other than barcode or 2D symbol data. If you use the font for other characters, the characters will not be printed. Therefore, make sure to select a True Type font that you do not use for printing data other than barcodes or 2D symbols.

User Defined Information

The following information is included in User Defined Information.

- User-defined paper settings
- Registered barcode font settings
- Font replacement settings for .NET environment

The user defined information is set on each client computer.

If multiple printer drivers have been installed on one computer, the information can be shared between the multiple printer drivers.

Exporting/Importing Printer Driver Settings

You can export Favorite Settings, user defined information, and Driver Preferences settings to a BSF file (the extension is .BSF). By importing the exported BSF file, the same settings can be applied to the printer driver on another computer.



- Note that the [Favorite Settings] function on the printer driver is completely different from the [Favorite Setting] function of the printer. It is impossible to include the [Favorite Setting] of the printer in the printer driver settings file.
- The BSF file contains the model number of the printer and the model number is checked when the file is imported to prevent mix up the file with the file for another printer model. In this way, the BSF file can be imported to only the printer driver for the printer with the same model number.

 ["Exporting Settings File" on page 129](#)

 ["Importing Settings File" on page 131](#)

Exporting Settings File

Export the settings file following the steps below.

1 Check that the set of print settings you want to export has been registered in [Favorite Settings].



- If there are multiple entries registered in [Favorite Settings], all entries are exported to the BSF file. When the BSF file is imported, the registered entry at the top of the settings list will be reflected. Edit the order of the registered entries as necessary.

“Favorite 1” will be reflected after import.

“Favorite 2” will be reflected after import.

“Favorite 3” will be reflected after import.

- To change the order in the [Favorite Settings] list, open the Save/Delete Favorite Setting screen, select a set of print settings, and then click [UP] or [Down].

- If no set of print settings has been registered in [Favorite Settings], default print settings of the printer driver is exported.

2 Select the [Driver Utilities] tab. Click [Import/Export Settings].

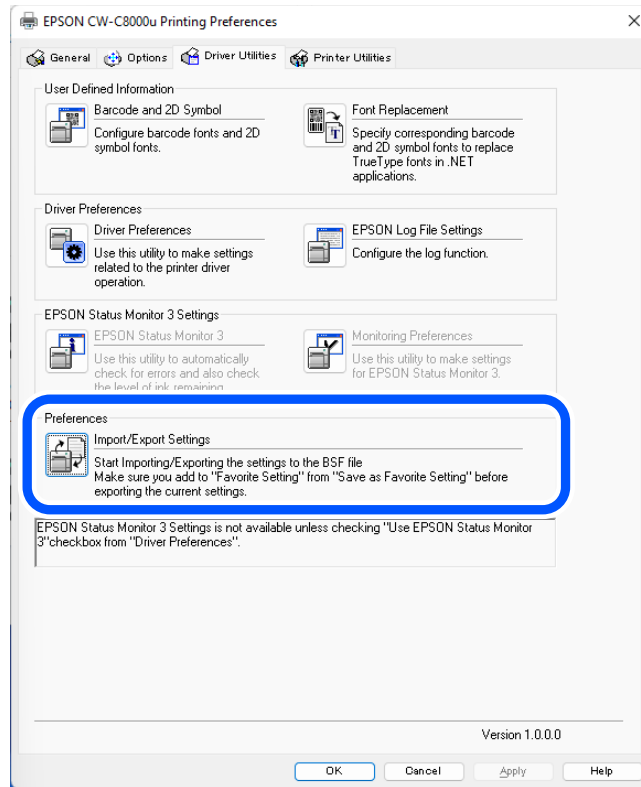

Export in a BSF file from [Printing References]. If you export it from [Printing Defaults], a different content will be exported.

- Printing References:
Properties of the printer driver - [General] - [Printing References] - [Driver Utilities] - [Import/Export Settings]
- Printing Defaults:
Properties of the printer driver - [Advanced] - [Printing Defaults]- [Driver Utilities] - [Import/Export Settings]

3 The Import/Export Settings window appears. Click [Export Settings].

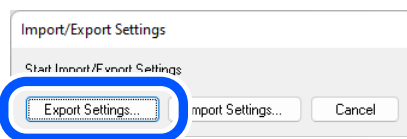

4 A window to save the settings file appears. Save the BSF file under a new file name.

5 The process completion screen appears. Click [OK].



To the BSF file, a set of print settings registered in [Favorite Settings] is exported. Print settings displayed in the [Current Settings] are not exported.

Importing Settings File



When the BSF file is imported to the printer driver, the printer driver settings are overwritten with the imported settings. If you keep the following settings unchanged, create BSF files to include them.

- List of Favorite Settings
- List of user-defined paper settings
- List of barcode fonts
- List of font replacement for barcode

Import the settings file following the steps below.

- 1** Select the [Driver Utilities] tab. Click [Import/Export Settings].
- 2** The Import/Export Settings window appears. Click [Import Settings].
- 3** A confirmation window appears. Click [OK].
- 4** The window to open a file appears. Select the file to be imported.
- 5** The process completion screen appears. Click [OK].

6 Check that the set of print settings you selected has been registered in [Favorite Settings].



- If there are multiple entries registered in [Favorite Settings], the registered entry at the top of the settings list will be reflected. If the registered entry you wanted is not reflected, modify the order of the settings list and export the BSF file again.

“Favorite 1” will be reflected after import.

“Favorite 2” will be reflected after import.

“Favorite 3” will be reflected after import.

- To change the order in the [Favorite Settings] list, open the Save/Delete Favorite Setting screen, select a set of print settings, and then click [UP] or [Down].

- If no set of print settings has been registered in [Favorite Settings], default print settings of the printer driver is applied.
- BSF files are not compatible in the following cases.
 - Between different driver versions
 - Between different builds/versions of Windows
 - Between different architectures of Windows (32-bit/64-bit)

Setting EPSON Status Monitor 3

EPSON Status Monitor 3 displays a pop-up window to inform you specified paper type and ink levels when you start printing. In addition, if a fatal error occurs, it displays an error window.

It is disabled by default.

Enabling/Disabling EPSON Status Monitor 3

By default, EPSON Status Monitor 3 is disabled.

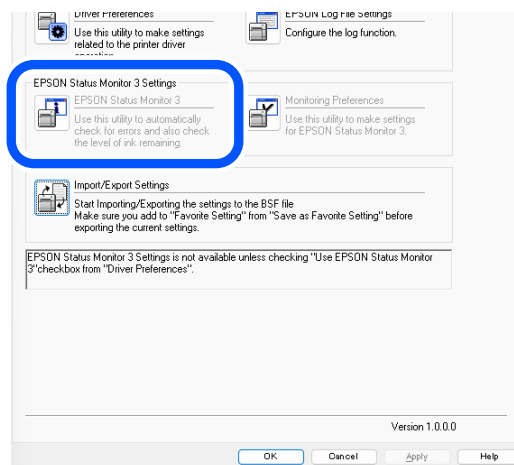

Follow the procedure below to enable EPSON Status Monitor 3.

- 1** Turn the printer on.
- 2** Open the printer driver window.
- 3** Select the [Driver Utilities] tab and then click [Driver Preferences] in the Driver Preferences field.
- 4** The Driver Preferences window appears. Select the check box for [Use EPSON Status Monitor 3], and then click [OK].

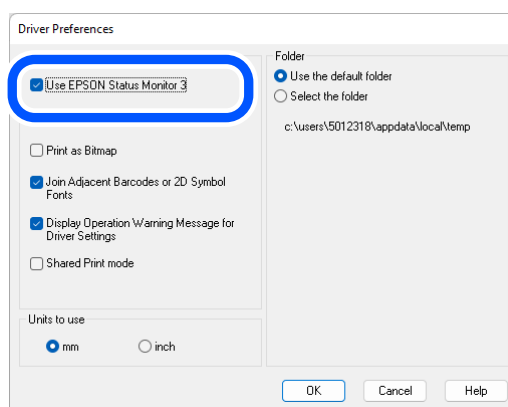

- 5 In the [EPSON Status Monitor 3 Settings] field on the [Driver Utilities] window, [EPSON Status Monitor 3] and [Monitoring Preferences] are displayed.

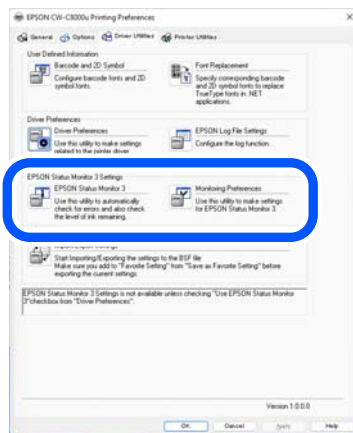

Using EPSON Status Monitor 3

When EPSON Status Monitor 3 is enabled, the following functions become available.

- A window to inform you the printer status and ink levels is automatically displayed when you start printing.
- You can check the consumables information on the General tab of the printer driver.
- When an error occurs during printing, the error information is displayed.

If an error occurs on the printer while it is not printing, EPSON Status Monitor 3 does not start.

- You can start EPSON Status Monitor 3 anytime by clicking its icon on the task bar.

For information on how to display the icon, refer to ["Displaying the Icon" on page 137](#).



EPSON Status Monitor 3 window



Icon on the task bar

- You can set the following in the [Monitoring Preferences] settings.

Display the EPSON Status Monitor 3 icon on the task bar.

(See ["Displaying the Icon" on page 137](#).)

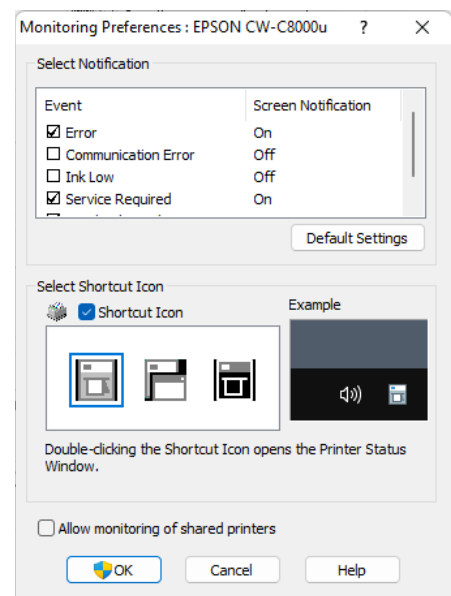

Error Notification Settings

Follow the procedure below to change the error notification settings of EPSON Status Monitor 3.

- 1** Turn the printer on.
- 2** Open the printer driver window.
- 3** Select the [Driver Utilities] tab and then click [Monitoring Preferences].
If you have not enabled EPSON Status Monitor 3, [Monitoring Preferences] is not displayed. Enable EPSON Status Monitor 3 referring to "[Enabling/Disabling EPSON Status Monitor 3](#)" on page 133.
- 4** The Monitor Preferences window appears. Select the check boxes for the items that you want to be notified, and then click [OK].

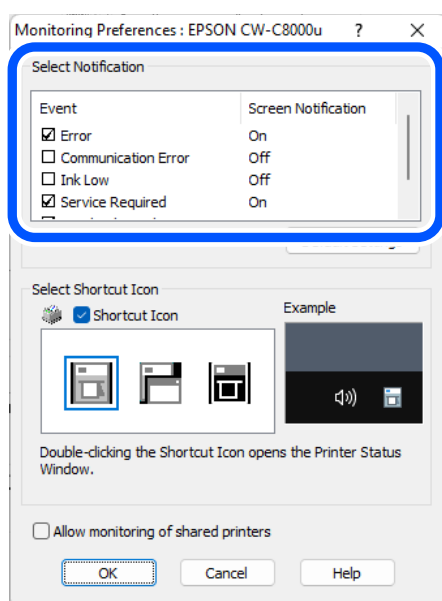

- Error: When paper/ink replacement is required (Default: Screen Notification [On])
- Communication Error: When the printer power is off (Default: Screen Notification [Off])
- Ink Low: When the ink amount is low (Default: Screen Notification [Off])
- Service Required: When a printer error occurs (Default: Screen Notification [On])
- Nozzle Clogged Warning: When the nozzles get clogged (Default: Screen Notification [On])

Displaying the Icon

You can set to show the icon on the task bar, and check the printer status by clicking the icon. The icon is not displayed by default. Follow the procedure below to display the icon.

- 1 Turn the printer on.**
- 2 Open the printer driver window.**
- 3 Select the [Driver Utilities] tab and then click [Monitoring Preferences].**
- 4 The Monitor Preferences window appears. Select the check box for [Shortcut Icon], and then select an icon image you want to display on the task bar. Click [OK].**

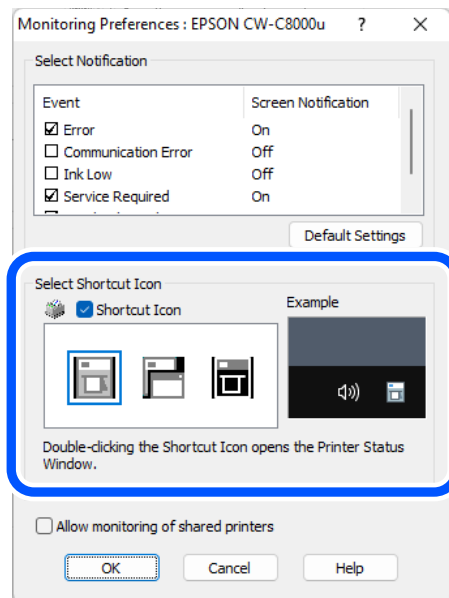

Starting PrinterSetting from the Printer Driver

Start PrinterSetting from the printer driver following the steps below.



If you start PrinterSetting with this procedure, some settings will not be available.
 ("PrinterSetting (Windows)" on page 185)

- 1 Open the printer driver window.
- 2 Select the [Printer Utilities] tab, and then click [Printer Settings].

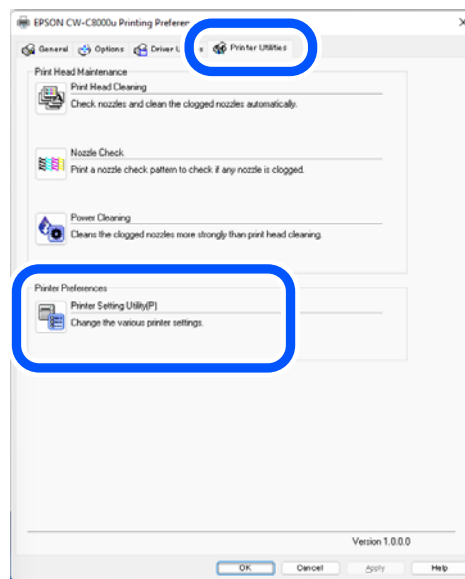

- 3 The CW-C8000 Series PrinterSetting screen appears.

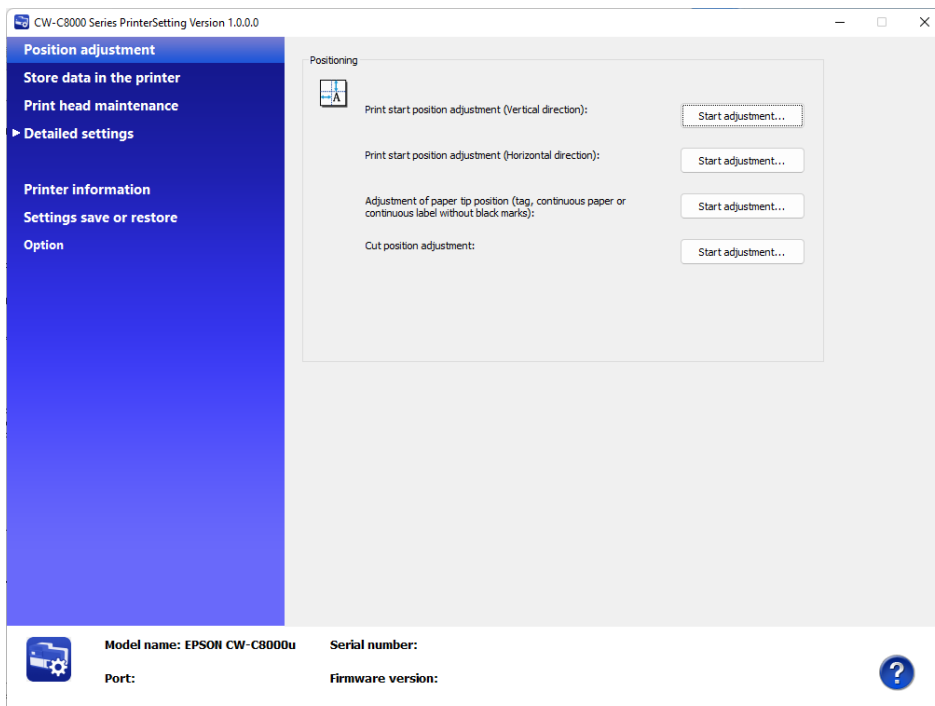

Restrictions on Using the Printer Driver

- The printer driver does not support printing a background image.
- To print multiple print jobs in time order, disable [Print spooled document first]. If the printer driver receives multiple print jobs with [Print spooled document first] enabled, the print jobs may not be printed in time order.

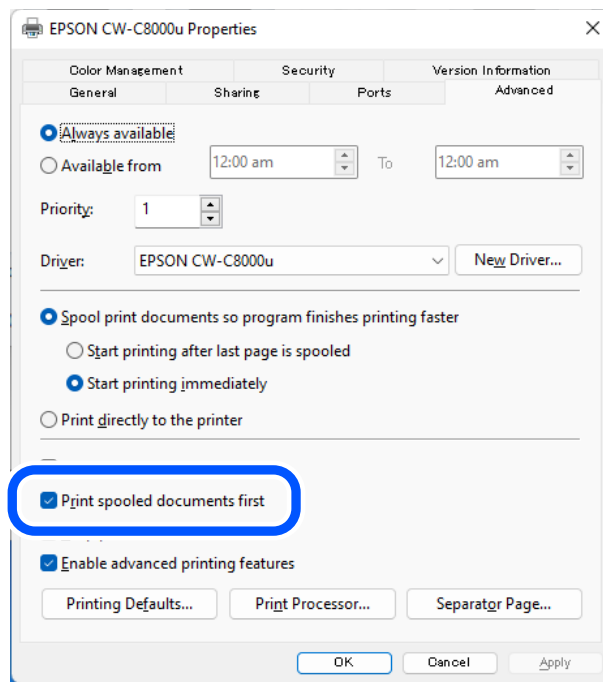

- When using Epson printer driver, do not change the control prefix, the format prefix, and the delimiter string that are included in ESC/Label command from their defaults. If you change them, printing will not be performed or result in producing unintended printouts. For their default settings, see "[Operation Panel Settings](#)" on page 223 and find [Printer Settings] - [Print Settings] - [Command Character].

Isolating the Printer Driver

You can improve the reliability of the Windows print service by running the printer driver in a separate process from the process that runs the print spooler. This is available by using the isolation function.

Follow the procedure below to enable the isolation of the printer driver.

1 Select [Start] – [Windows Administrative Tools] – [Print Management].

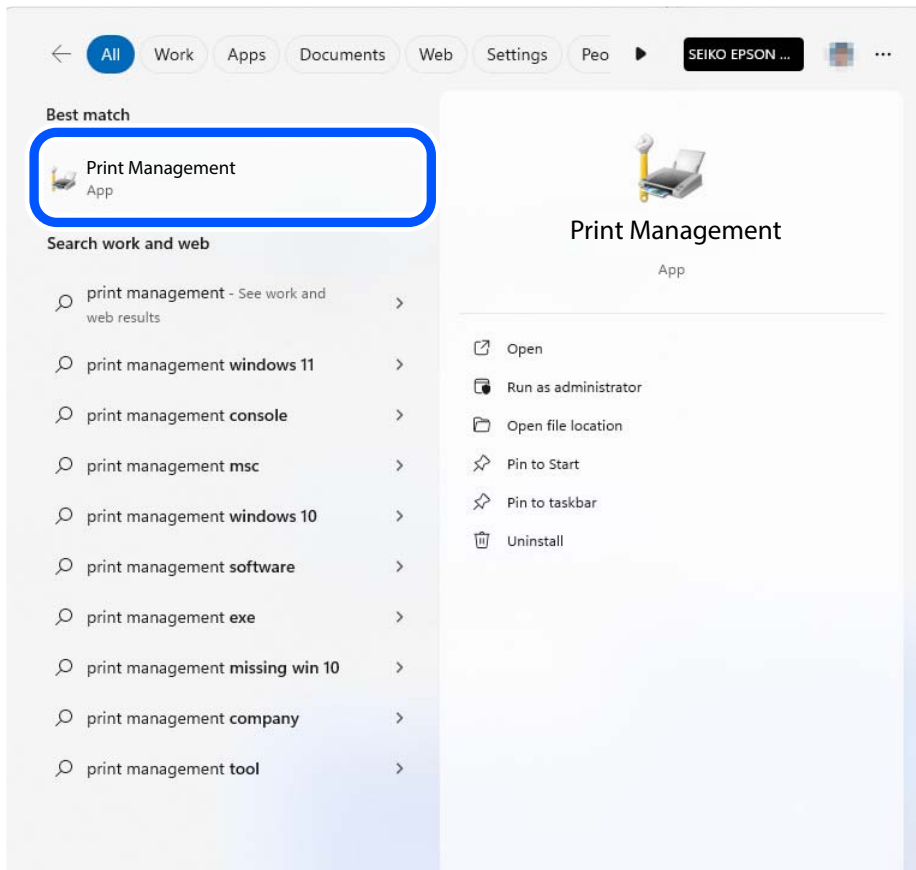

2 From [Driver Name], select [EPSON CW-C8000u].

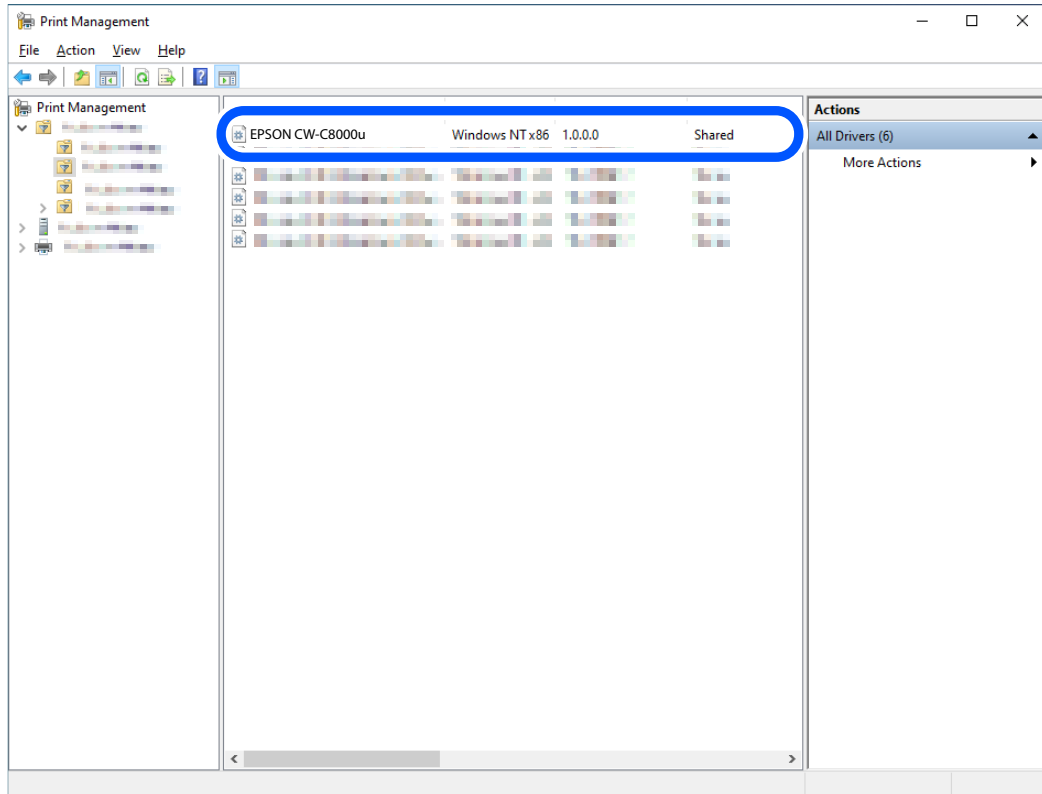

The above step is an example when your printer name is "EPOSN CW-C8000u".

3 Select [Actions] – [More Action] – [Set Driver Isolation] – [Isolated].

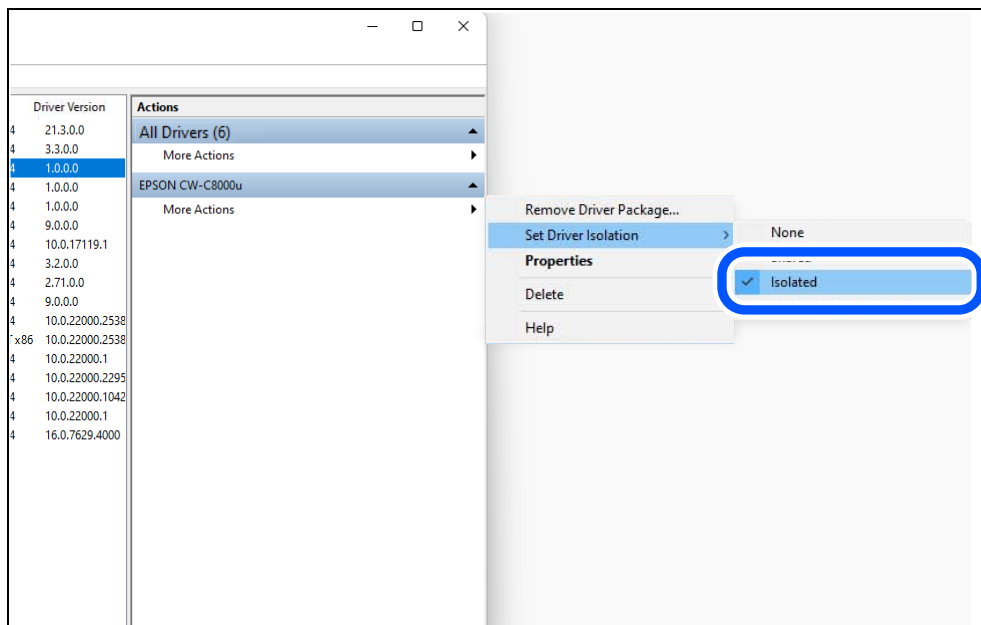

Sharing the Printer Driver on the Server PC to Print

The printer driver installed on a server can be shared and used by multiple client computers. Since the clients can use the printer driver settings made on the server, various printing settings can be shared easily. This saves you the trouble of installing and setting the printer driver on each client computer.

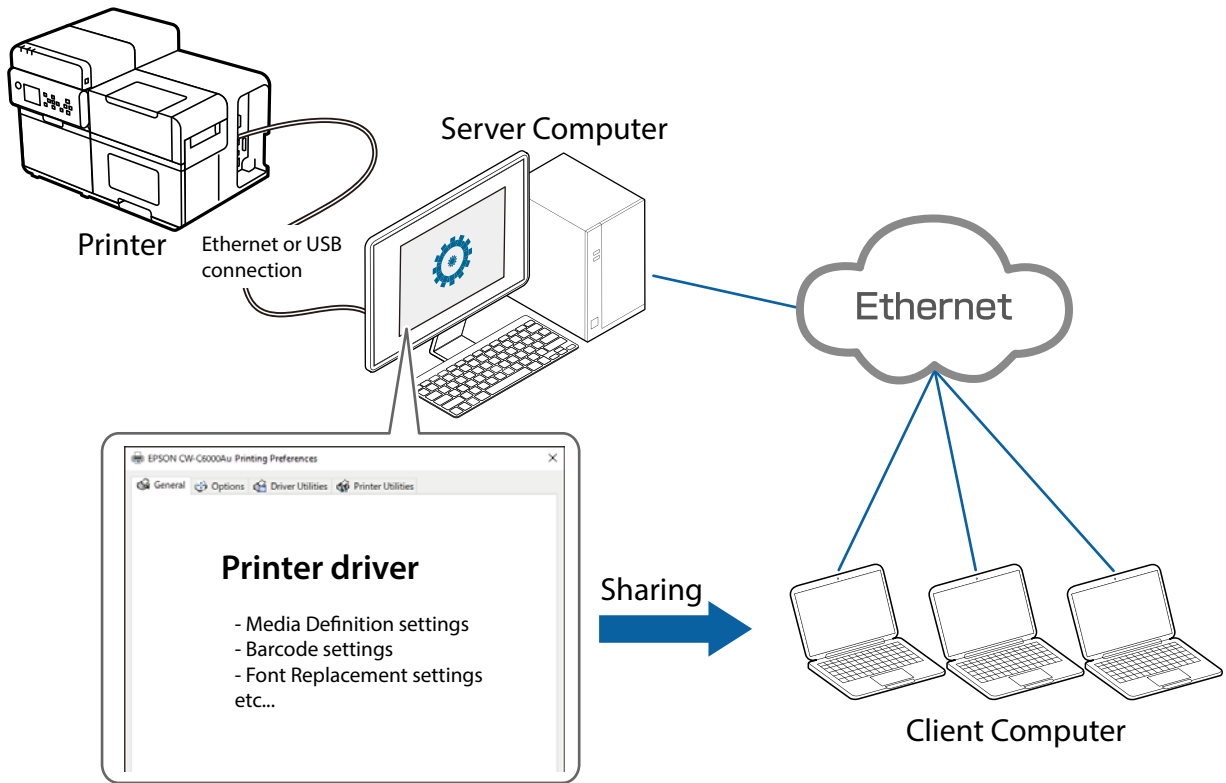

IMPORTANT

Depending on configuration of your system, starting PrinterSetting ([Page 185](#)) from the printer driver is disabled. "[Restrictions on using PrinterSetting](#)" on page 164



Ethernet connection allows you to control multiple printers if they are connected to the same network as the server computer.

Follow the steps below to enable sharing of the printer driver. For details of each step, see the linked page.

Procedure on a Server Computer

1. Install the printer driver ([Page 50](#))

The installation procedure is the same as installing it on a client computer.

2. Set up the sharing settings in the printer's properties ([Page 144](#))

3. Enable Shared Print mode on the printer driver ([Page 146](#))

4. Add new settings such as user-defined paper (Media Definition) on the printer driver

See "[User-Defined Paper](#)" on page 98, "[Printing Barcodes](#)" on page 108, or other pages as necessary.

5. Change the default settings of the printer driver ([Page 149](#))

Change the default printer driver settings to frequently used settings.



Procedure on a Client Computer

1. Connect to the server computer ([Page 151](#))

2. Check the settings of the shared printer driver ([Page 158](#))

Check that the settings made at step 3 to 5 of "Procedure on a Server Computer" are correctly applied.



IMPORTANT

- Shared Print mode is a function that assumes that the server PC, client PC, and printer are all connected and running.
- When you add new settings to the printer driver such as user-defined paper (Media Definition) or barcode font, make sure to add them after enabling [Shared Print mode]. The settings you added before enabling [Shared Print mode] become disabled because save location of the settings files is changed when the mode is enabled.
- The settings for shared information can only be added or changed using administrator privileges. As an account with user privileges cannot write from either a server PC or client PC, adding, editing, and deleting operations for the following functions are disabled.
 - Media Definition settings
 - Barcode and 2D Symbol Settings
 - Font Replacement
 - Favorite Settings
- If the server PC and client PC are not connected, the shared information settings cannot be changed.

Procedure on a Server Computer

Setting up the Sharing Settings in the Printer's Properties

- 1 Open [Printers & scanners].
- 2 Click the icon of the printer to be shared and then click [Printer properties].
The Printer properties window appears.



- 3 Click the [Sharing] tab, and then select the check box for [Share this printer].

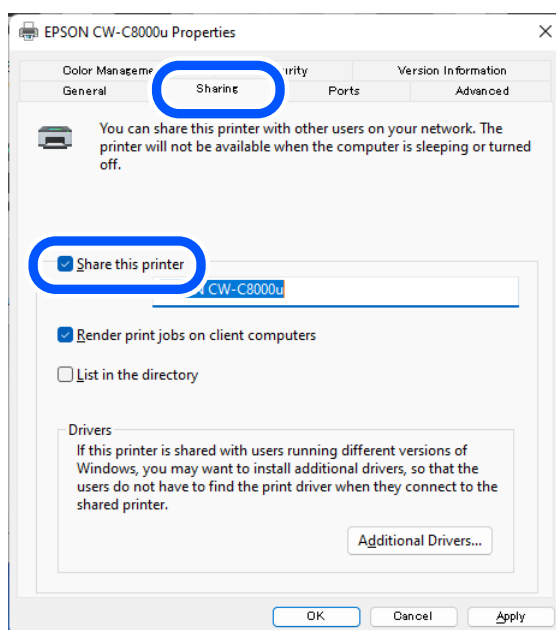

4 Select the check box for [Render print jobs on client computers].

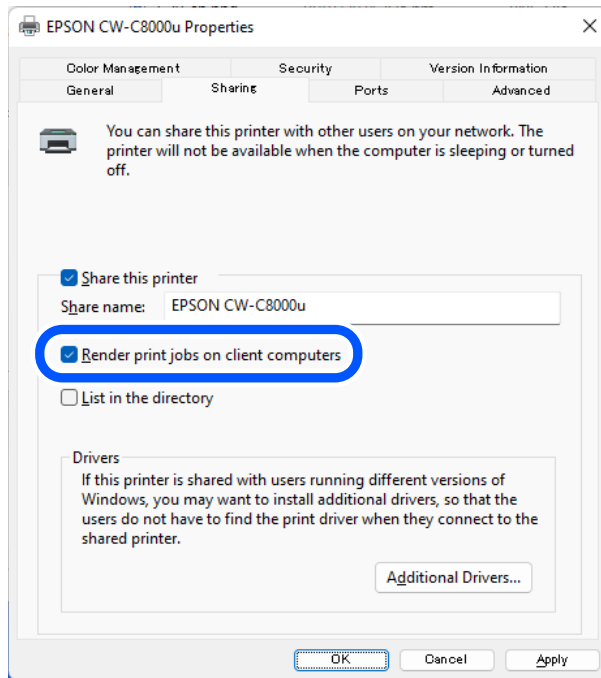

5 Click [OK].

Enabling Shared Print Mode on the Printer Driver

- 1 Open [Printers & scanners].
- 2 Click the icon of the printer to be shared and then click [Printer properties].
The Printer properties window appears.

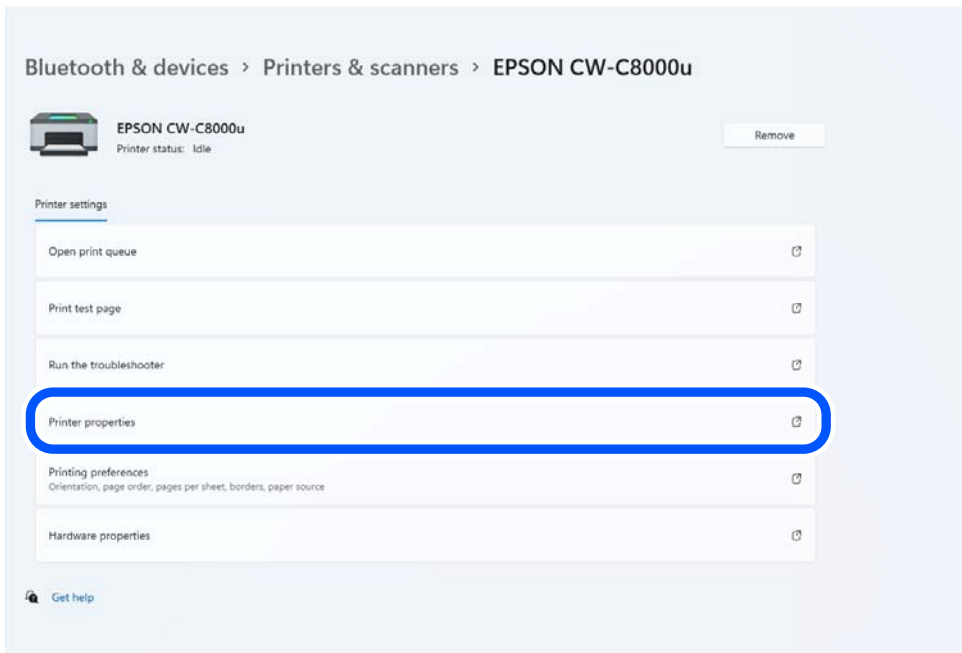

- 3 Click the [Advanced] tab, and then click [Printing Defaults].

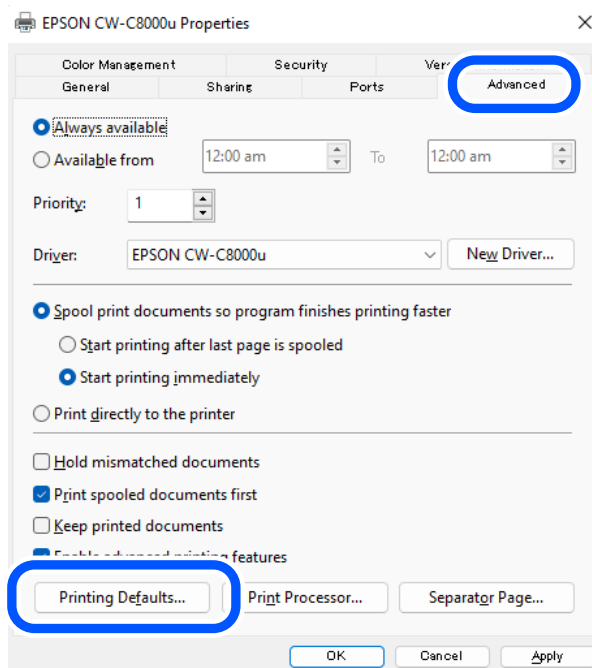

- 4** When print settings window appears, select the [Driver Utilities] tab, and then click [Driver Preferences].

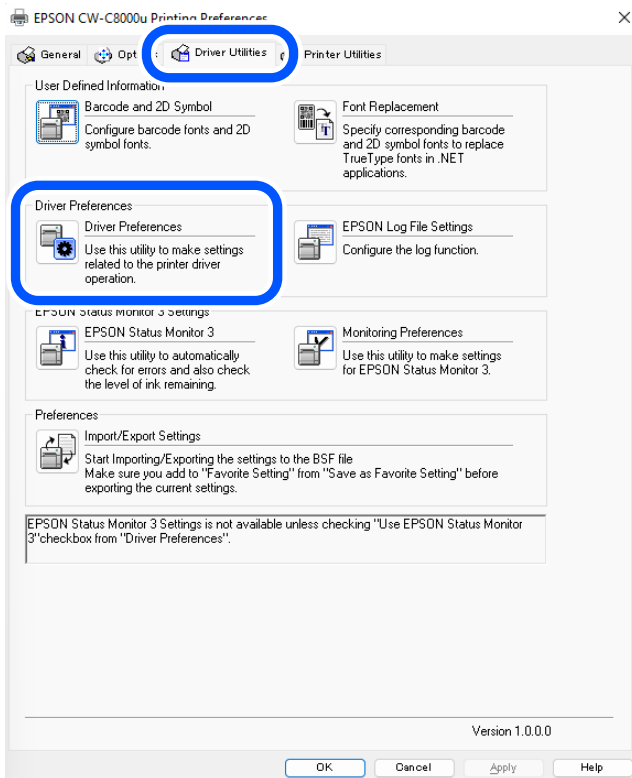

- 5** On the “Driver Preferences” window, select the check box for [Use EPSON Status Monitor 3] and [Shared Print mode].

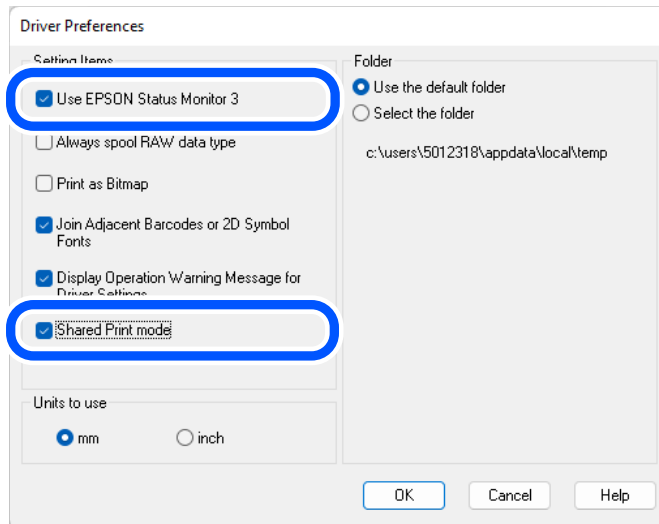

- 6** Click [OK] to return to the previous print settings window.

- 7** Click [Monitoring Preferences] on the “Driver Utilities” tab. The “Monitoring Preferences” window appears.

- 8 Select the check box for [Allow monitoring of shared printers], and then click [OK].

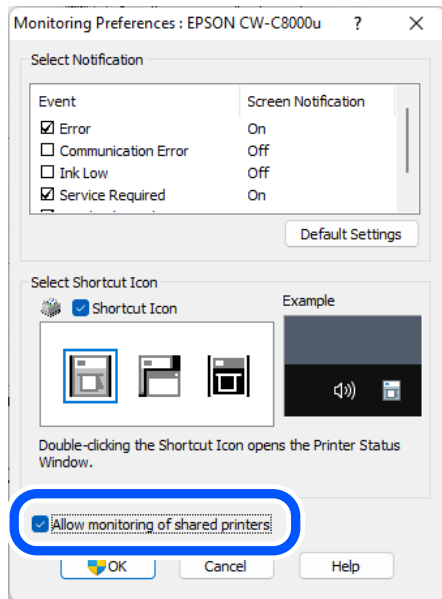

- 9 When the print settings window reappears, click [OK].
The [Shared Print mode] setting is enabled from the next time you open the print settings window of the printer driver.

Changing the Default Settings of the Printer Driver

You can change the default settings of the printer driver to frequently used settings such as selecting paper you added at [Media Definition]. This saves you the trouble of changing the settings each time you print.

If necessary, first add [Media Definition] settings ("[User-Defined Paper](#)" on page 98), barcode font ("[Printing Barcodes](#)" on page 108), or other settings, and then follow the procedure below to change the default settings.

IMPORTANT

- When you add new settings to the printer driver such as user-defined paper (Media Definition) or barcode font, make sure to add them after enabling [Shared Print mode]. The settings you added before enabling [Shared Print mode] become disabled because save location of the settings files is changed when the mode is enabled.
- If you log in to the server or client computer with user privileges after setting up sharing settings, adding, editing, or deleting operations for the following functions are disabled because shared information is write-protected. Log in to the computer with administrator privileges.
 - Media Definition settings
 - Barcode and 2D Symbol Settings
 - Font Replacement
 - Favorite Settings

- 1 Open [Printers & scanners].
- 2 Click the icon of the printer to be shared and then click [Printer properties].
The Printer properties window appears.

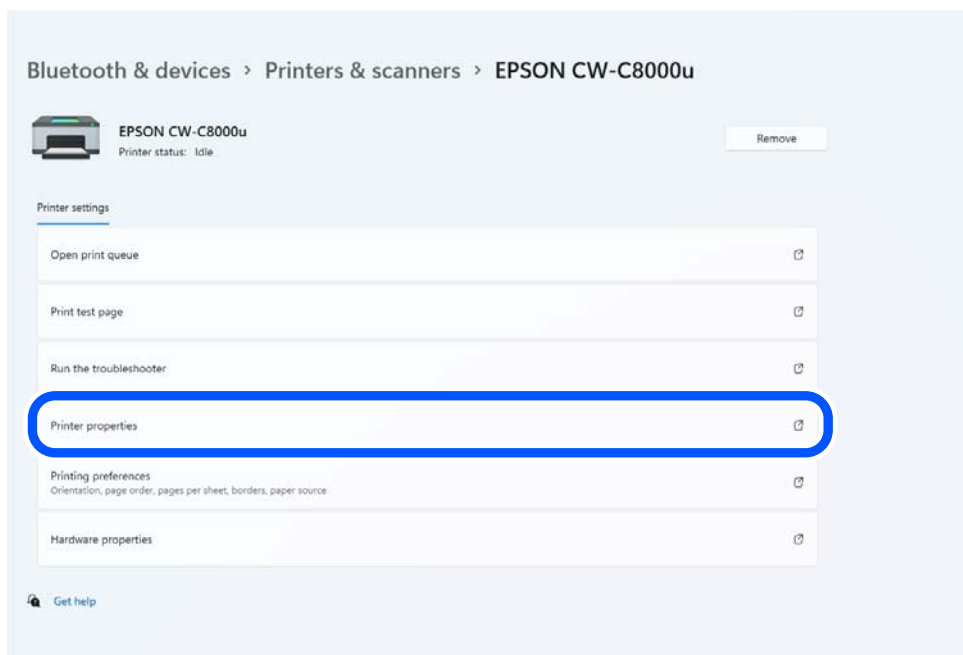

3 Click the [Advanced] tab, and then click [Printing Defaults].

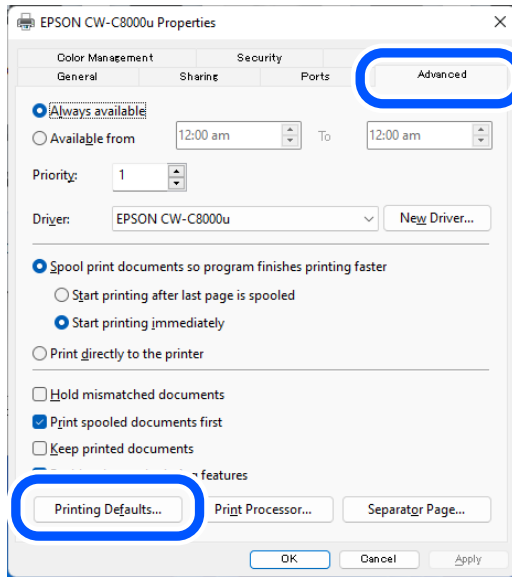

4 When the print settings window appears, change paper and other settings to frequently used settings.

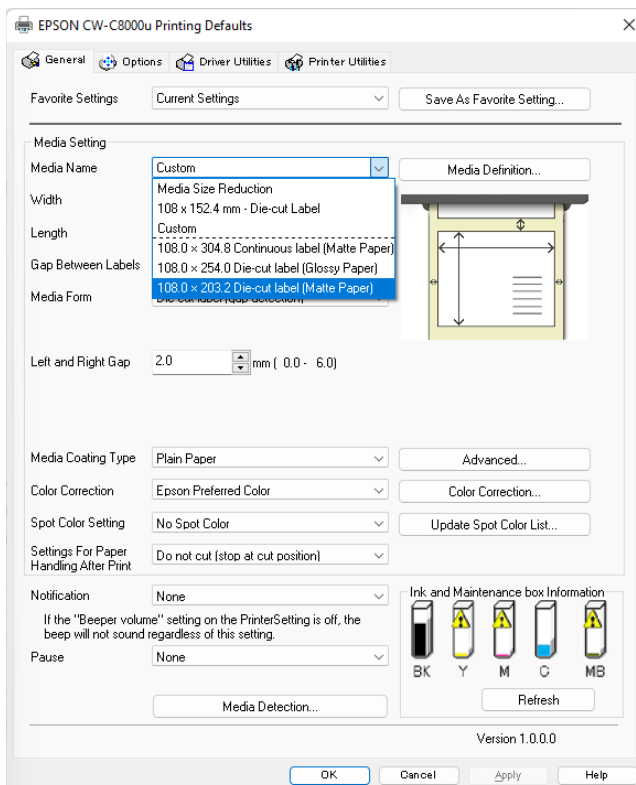

5 When finished, click [OK] to save the changes.

From the next time you open the printer driver, the print setting you made here will be reflected.

Procedure on a Client Computer

Connecting to the Server Computer

- 1 **Open [Printers & scanners] and then click [Add device].**
Searching for a printer is started.

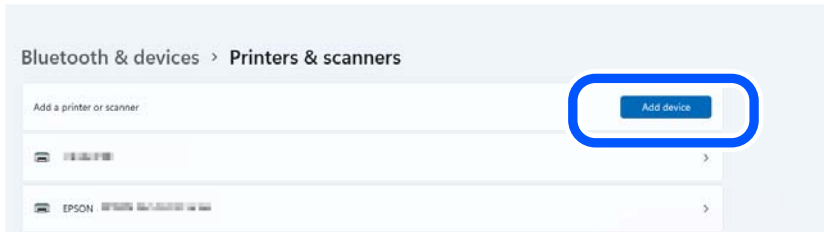

- 2 **When the target printer is displayed, click [Add device].**
If the printer is not displayed, go to ["Connecting to the Server Computer \(When the Printer is Not Found\)"](#) on page 154.

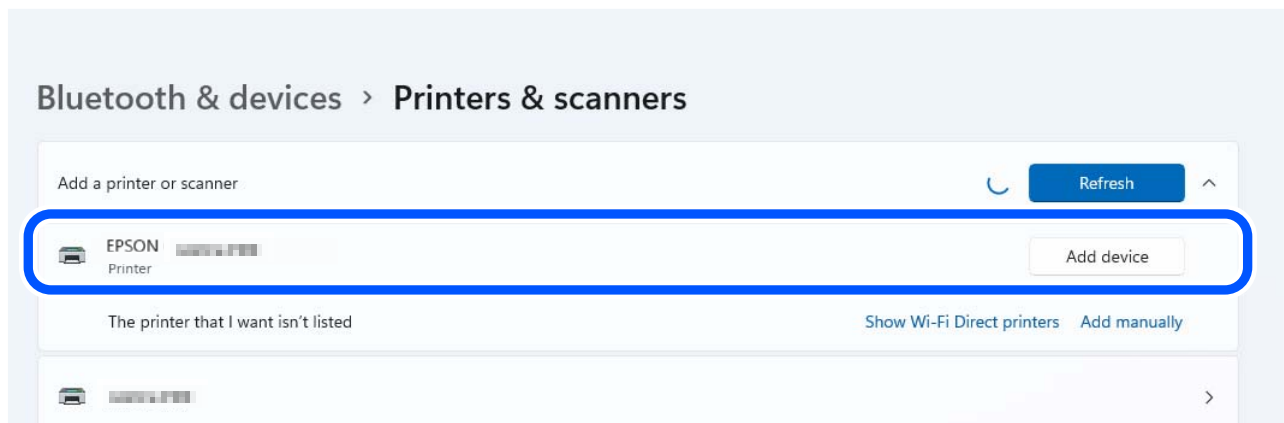

- 3 **Wait until installation of the printer driver is finished.**

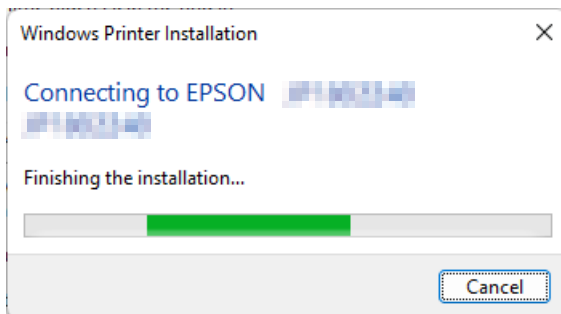

- 4** When the installation finishes successfully, the window below is displayed. Click [Next].

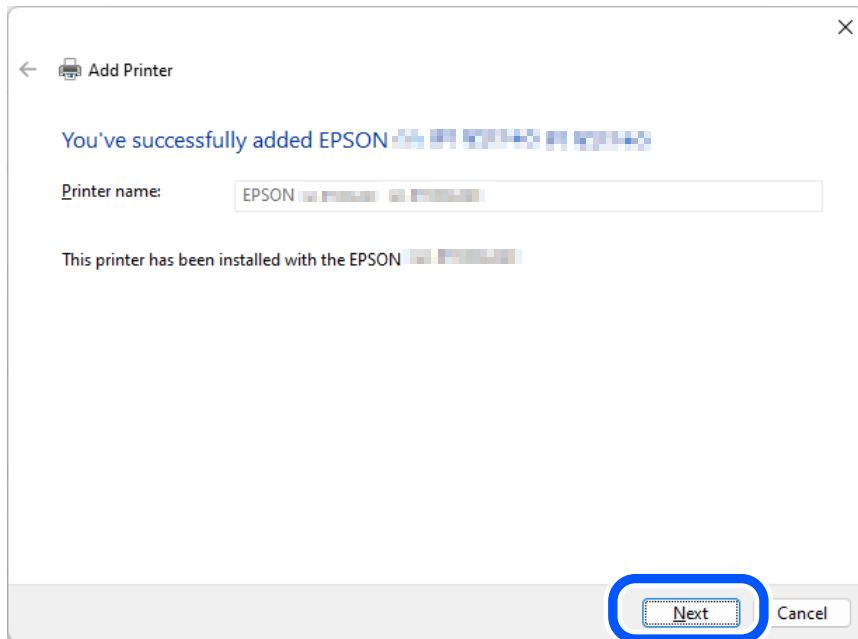

- 5** The window shown below is displayed. Click [Print a test page] to test whether printing from the printer is possible, or click [Finish] to finish.

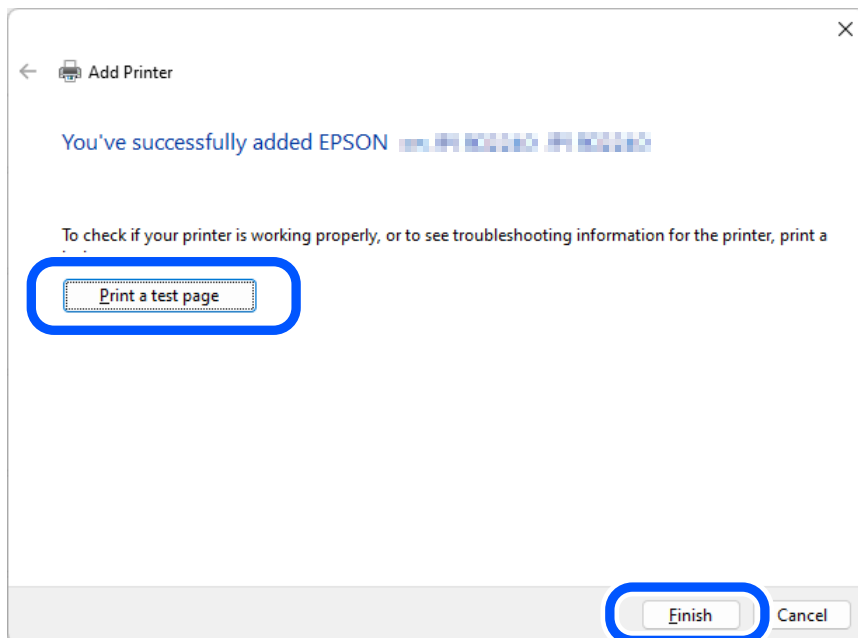

- 6 Open [Printers & scanners] again to check that the printer has been added in the window.

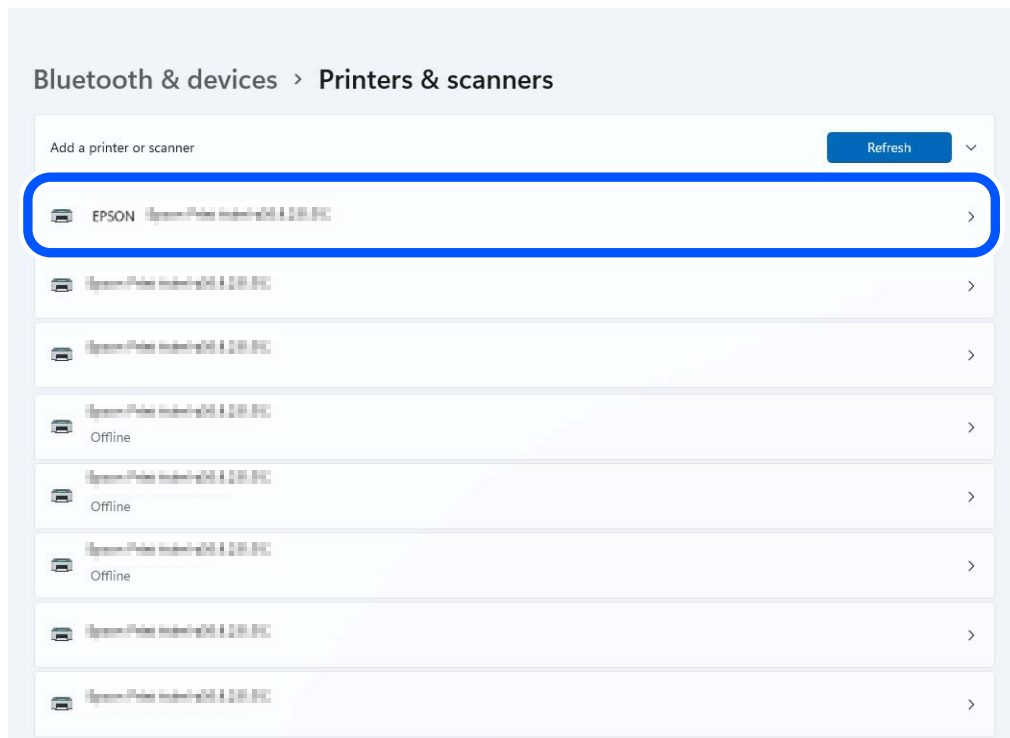

Connecting to the Server Computer (When the Printer is Not Found)

If the printer is not displayed after clicking the [Add device] in [Printers & scanners], follow the procedure below.

- 1 Click [Add manually] next to a message "The printer that I want isn't listed".

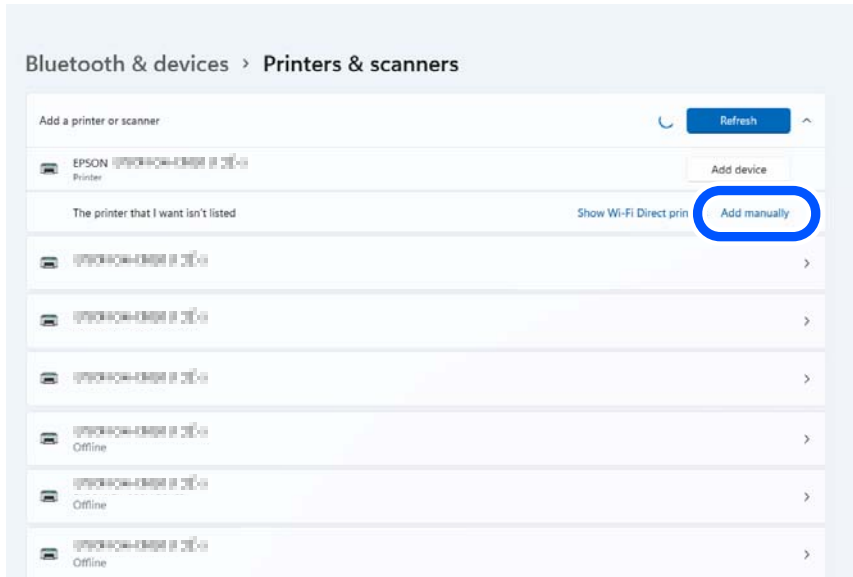

- 2 When the window shown below appears, select [Select a shared printer by name] and then click [Browse].

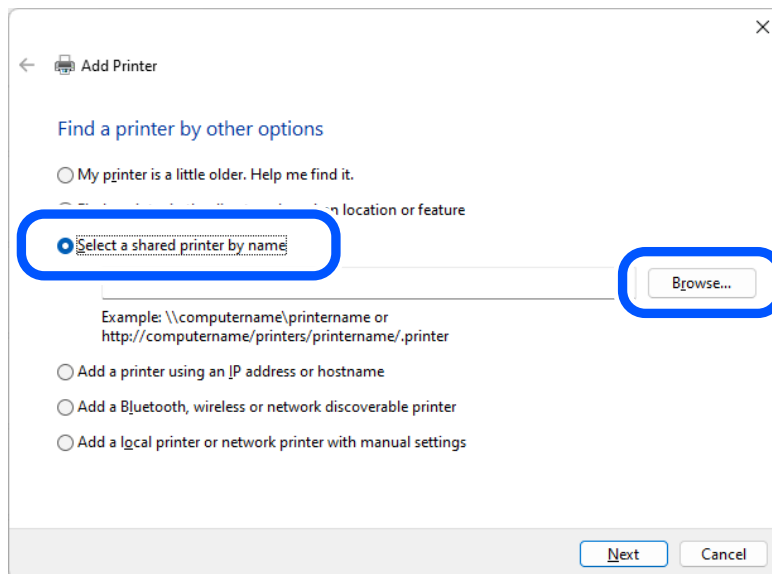

- 3** When the server computer is displayed under [Network], click on it.
All devices shared on the server computer are listed.

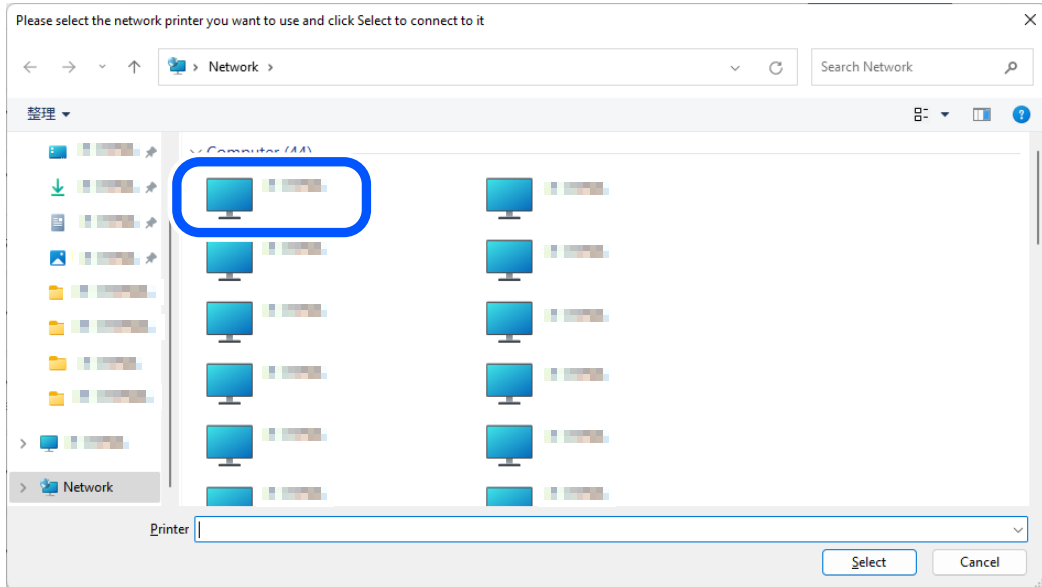

If network discovery has been disabled on the computer, change the setting to enable network discovery.

- 4** Click on the target printer. Check that the printer name is correct, and then click [Select].

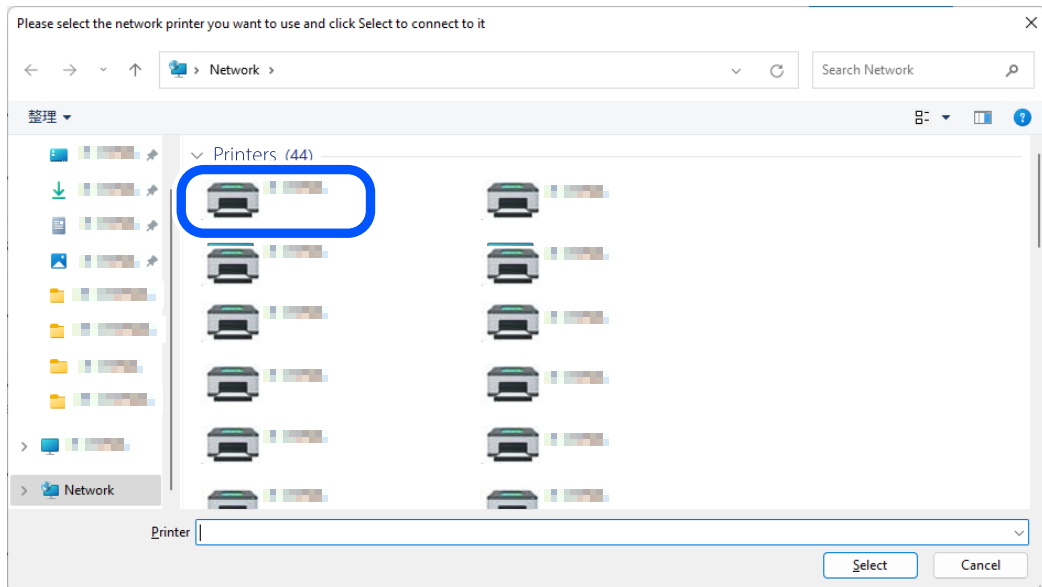

- 5** When the window shown below is displayed, click [Next].
Wait until installation of the printer driver is finished.

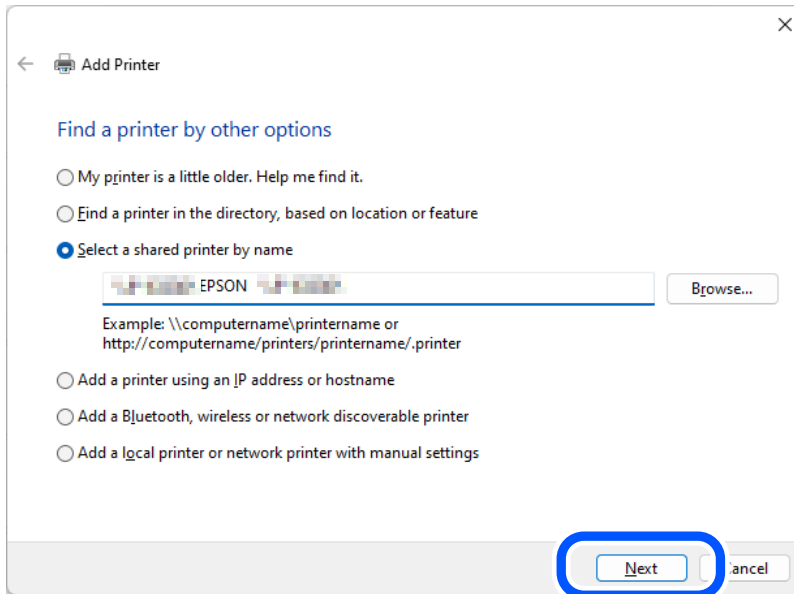

- 6** When the installation finishes successfully, the window below is displayed. Click [Next].

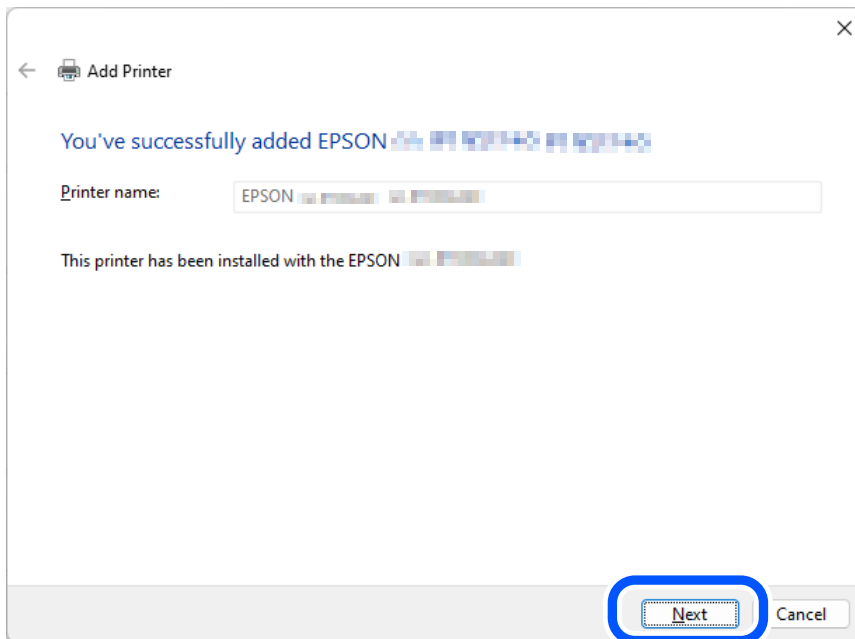

- 7** The window shown below is displayed. Click [Print a test page] to test whether printing from the printer is possible, or click [Finish] to finish.

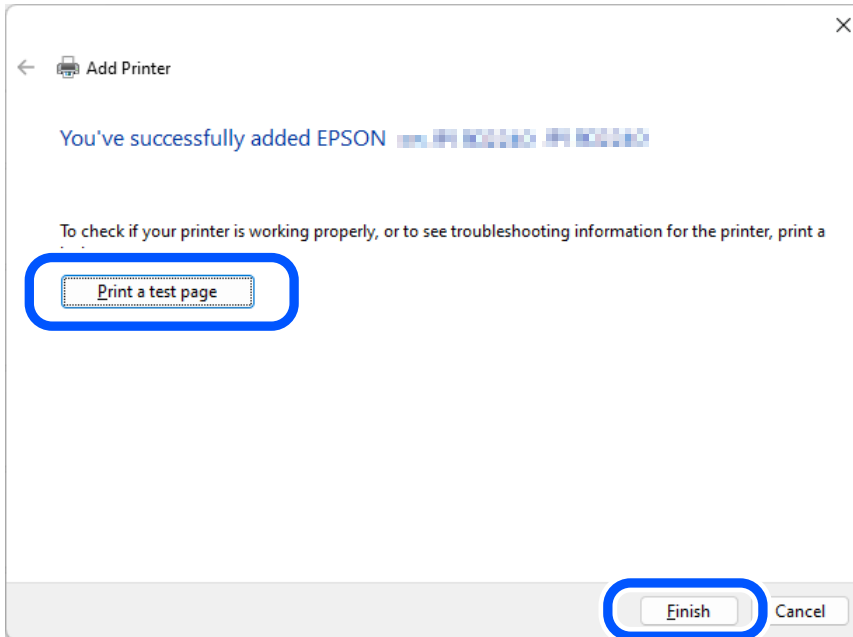

- 8** Open [Printers & scanners] again to check that the printer has been added in the window.

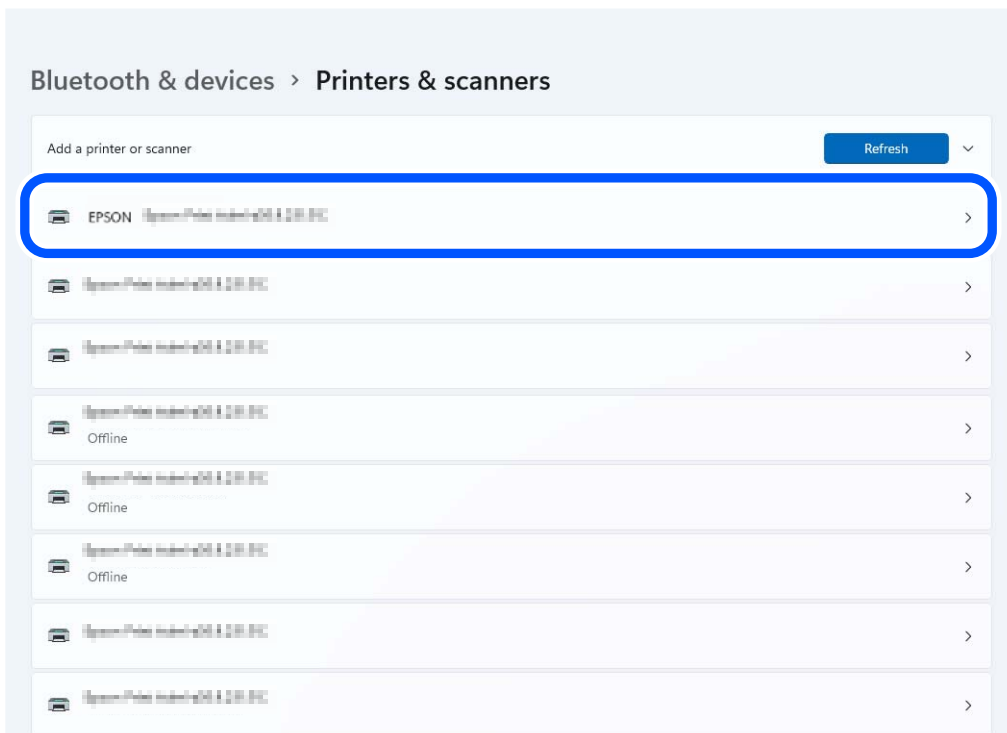

Checking the Settings of the Shared Printer Driver

There are the following two methods for checking the printer driver settings.

- Open the printer driver window from application software you use and check the settings ([Page 158](#))
- Open the printer driver window from [Printers & scanners] and check the settings ([Page 161](#))

❑ Checking the Settings from Application Software, taking Paint for example

1 Select [Print] from the [File] menu.

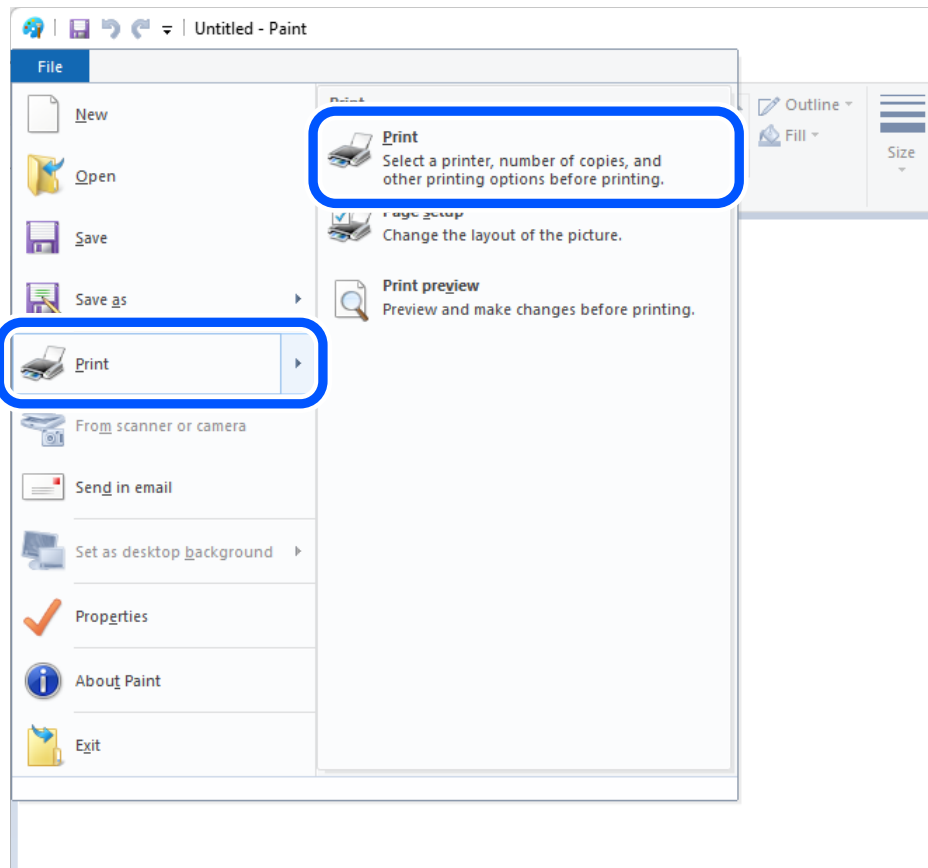

- 2** In the “Print” window, select the target printer and then click [Preferences].
The printer driver print settings window is displayed.

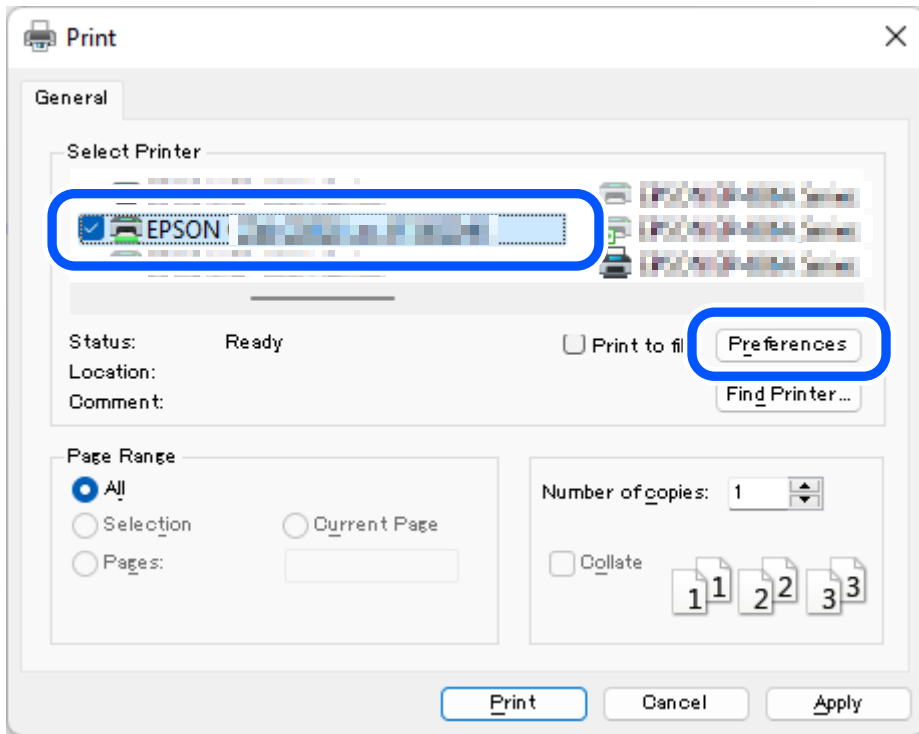

- 3** Check the print settings.
Check that the settings such as the selected media (paper) are the same as those you made at ["Changing the Default Settings of the Printer Driver" on page 149](#). When finished checking the settings, go to the next step.

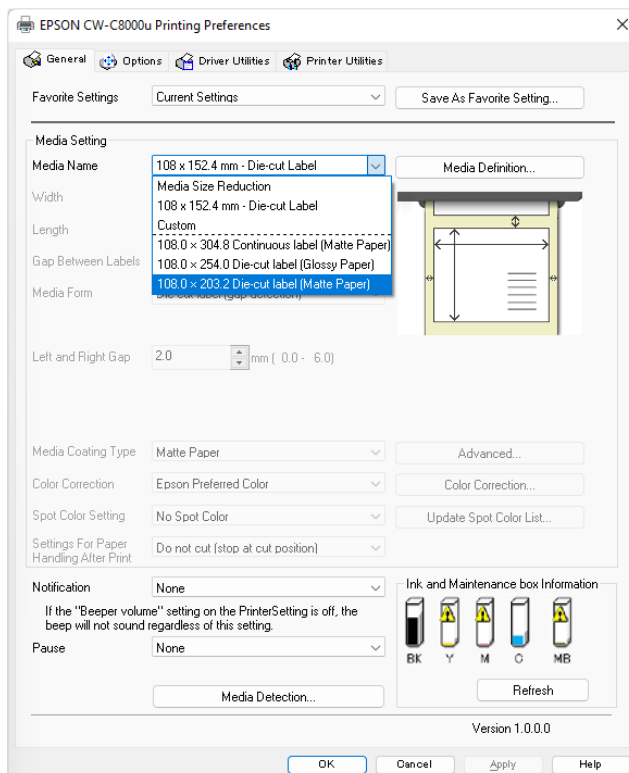

4 Select the [Driver Utilities] tab, and then click [Driver Preferences].

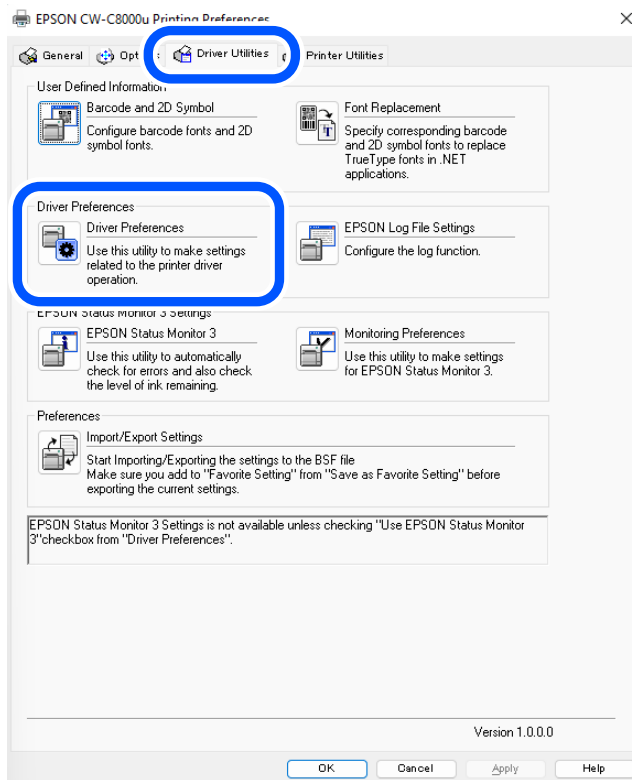

5 On the “Driver Preferences” window, check that the check box for [Shared Print mode] has been selected.

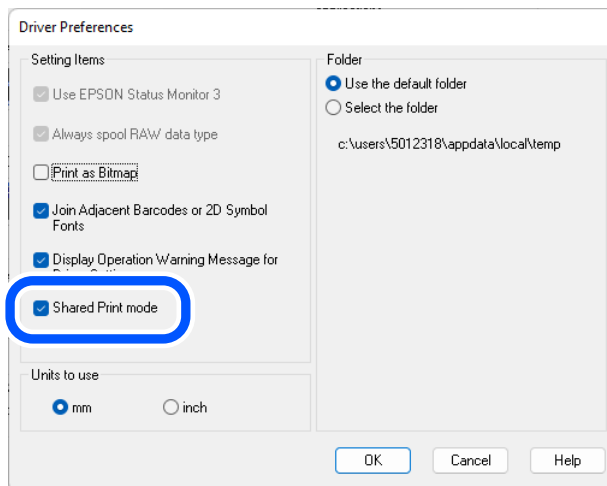

❑ Checking the Settings from [Printers & scanners]

- 1 Open [Printers & scanners].
- 2 Click on the target printer, and then click [Printing preferences].
The printer driver print settings window is displayed.

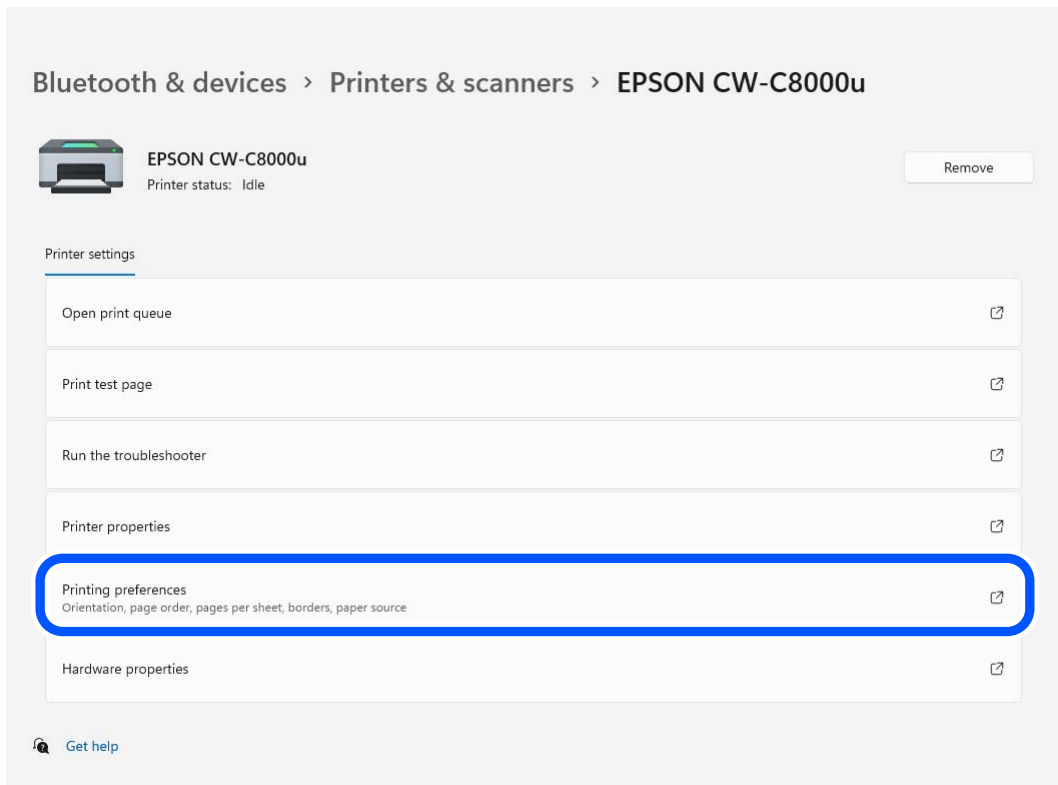

3 Check the print settings.

Check that the settings such as the selected media (paper) are the same as those you made at "Changing the Default Settings of the Printer Driver" on page 149. When finished checking the settings, go to the next step.

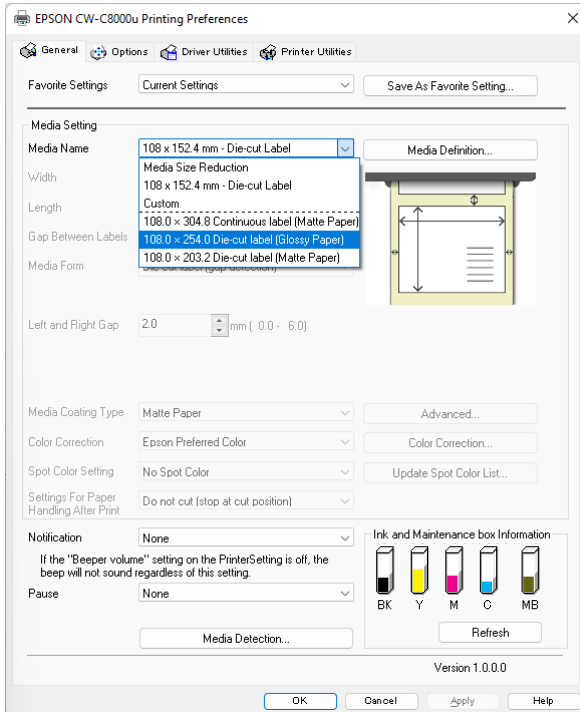

4 Select the [Driver Utilities] tab, and then click [Driver Preferences].

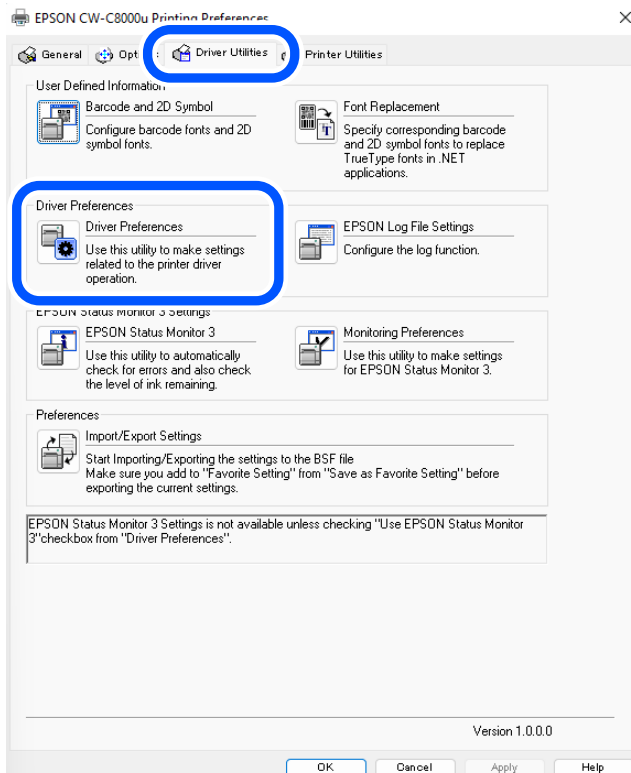

- 5 On the “Driver Preferences” window, check that the check box for [Shared Print mode] has been selected.

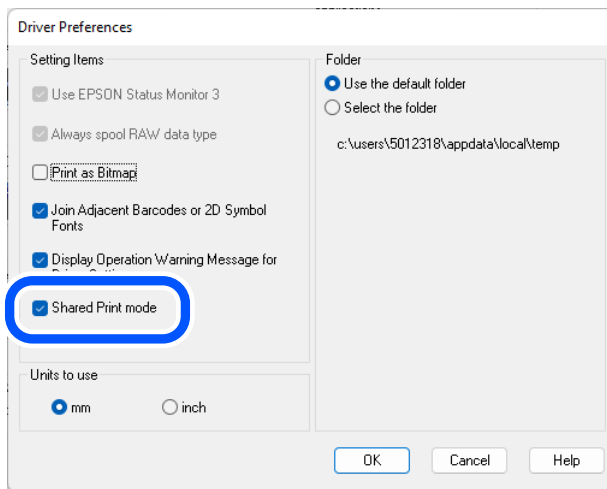

- 6 Click [Cancel] to close the “Driver Preferences” window and return to the previous print settings window.
- 7 Click [Cancel] or click [X] at the upper right corner to close the print settings window.

IMPORTANT

Do not click [OK] to close the print settings window that was displayed from [Printers & scanners] on a client computer. If you click [OK], the settings are saved on the client computer and the link with the server computer is disconnected.

Restrictions on using PrinterSetting

Depending on configuration of your system, starting PrinterSetting (Printer Settings Utility) from the “Printer Utilities” tab is disabled.

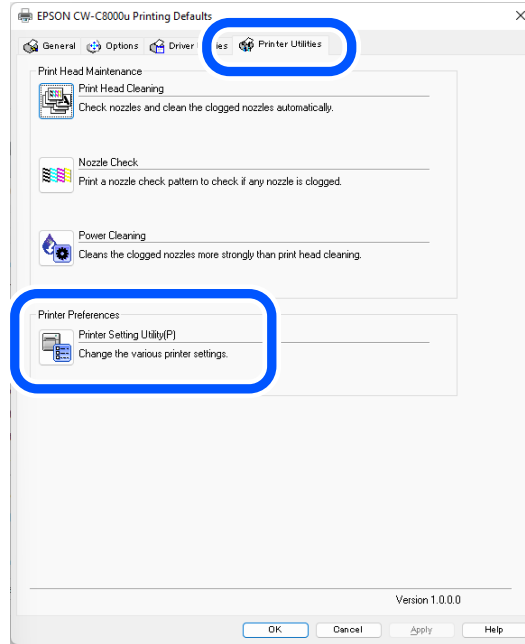

The table below shows system configuration examples and their restrictions on using PrinterSetting.

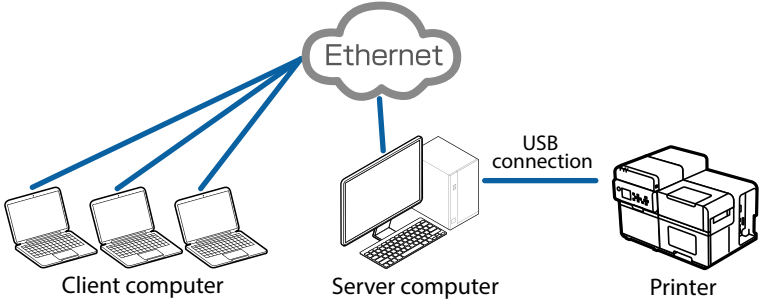
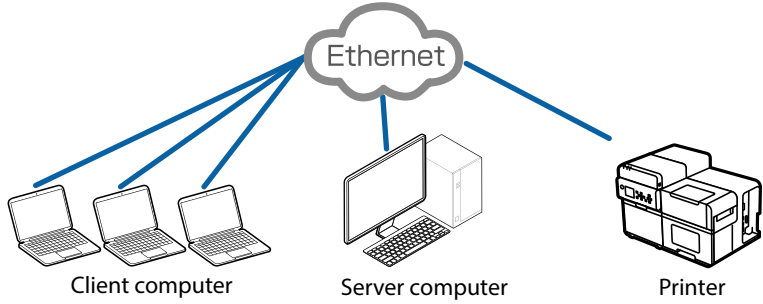
System Configuration	Starting PrinterSetting	
	Server Computer	Client Computer
<p>The printer is connected to the server computer via USB. The server and client computers are connected via a network</p> 	Possible	Not possible
<p>The server computer, the client computer, and the printer are each connected to the same network.</p> 	Possible	Possible after installing PrinterSetting application

Printer Driver for Mac

This chapter describes how to operate the printer driver for Mac.

The printer driver is software to control the printer in accordance with the print instructions of application software. Setting the print settings in the printer driver screen enables you to obtain the best print results. Furthermore, you can also use the utilities to check the printer status and perform maintenance.

Basic Procedure for Printing

- 1 Turn on the printer, and then load paper in the printer. ("[Loading Paper](#)" on page 66)
- 2 Create data to print on an application software, then select the [File] menu and click [Print].

The following screenshots are from Preview.

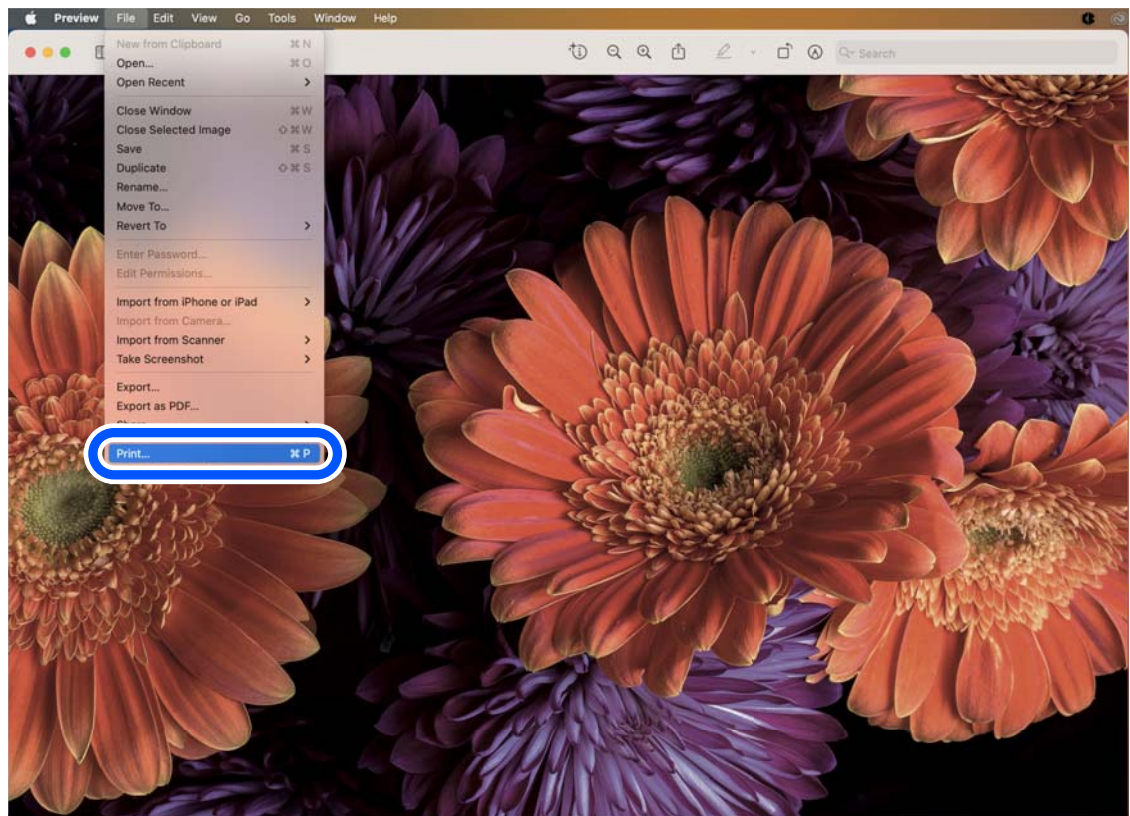

- 3** Check that this printer is selected, and then set the paper size. Select [Manage Custom Sizes] to set a custom paper size.

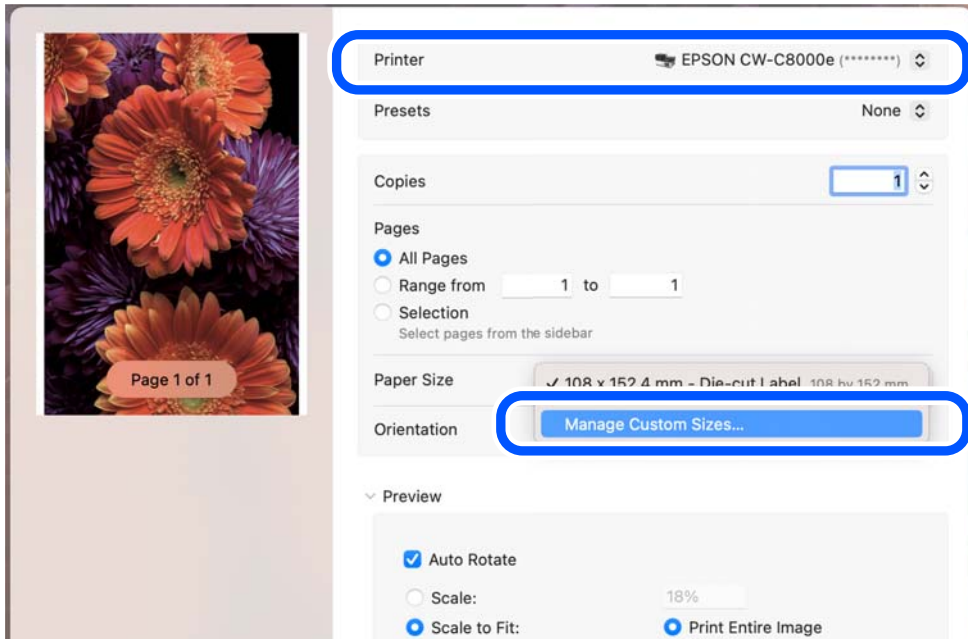

- 4** Click [+] to add a new set of paper size settings.

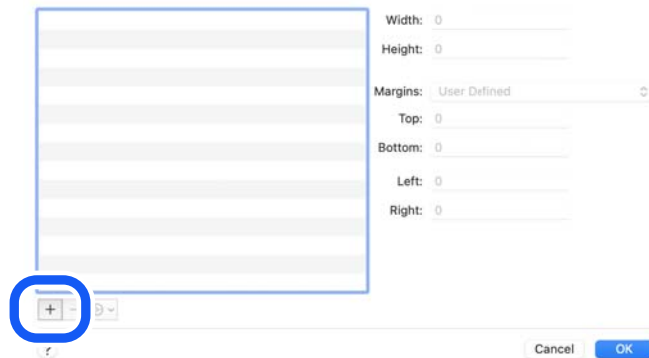

5 Enter paper size and make the margin setting of the printer.

Enter the paper size.

Set all top, bottom, left and right margins to 0 mm {0.00 in.}.



IMPORTANT

The paper size set in the Mac driver may not match the paper size displayed on the operation panel of the printer.

Example 1) When printing 15.0 mm {0.59 in.} width labels from Mac driver

- Setting value for width (Mac driver): 15.0 mm {0.59 in.}
- Setting value for width (operation panel): 14.8 mm {0.58 in.}

Example 2) When printing 212.0 mm {8.35 in.} height labels from Mac driver

- Setting value for height (Mac driver): 212.0 mm {8.35 in.}
- Setting value for height (operation panel): 211.7 mm {8.33 in.}

If setting the paper size, check the value displayed on the operation panel first.

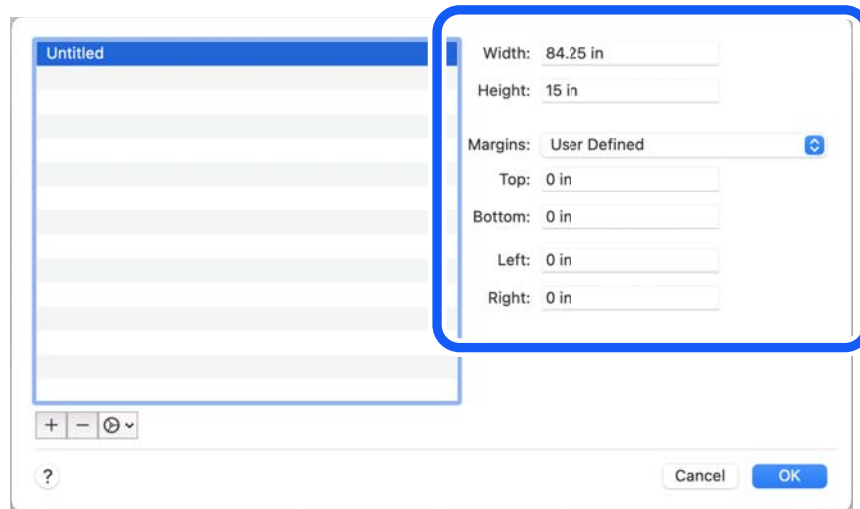

6 Click [Untitled] and enter a name for the custom size, and then click [OK].

The new paper size is applied to the printer driver.

7 Change the other settings to make them suitable for your label paper.

The following introduces setting menus that are unique to the printer.



- To change the paper source setting of the printer, change it using Epson Label Printer Utility. ("[Epson Label Printer Utility](#)" on page 175)
- You can change the default [Media Coating Type] setting of the printer driver following the procedure below.
 1. From the Apple menu, select [System Preferences] - [Printers & Scanners].
 2. Select the printer, and then click [Options & Supplies] - [Option].
 3. Change the setting.
- If setting menus described here are not displayed in the list, the dedicated printer driver for this printer has not been added.
Add the dedicated printer driver following the procedure in the link below. ("[Selecting the Dedicated Printer Driver](#)" on page 172)

1 Print Settings

Select the type of paper you use.

Item	Description	Default
Width	Allows you to set the paper width.	108.0 mm {4.25 in.}
Length	Allows you to set the paper length.	152.4 mm {6.00 in.}
Media Coating Type	Allows you to select paper type.	Matte paper
Print Speed	Allows you to select print speed.	300 mm/s {11.8 in/s}
Head Maintenance	Allows you to set print head flushing operation.	Pause for Maintenance

2 Color Options

This menu is enabled if you have selected [EPSON Color Controls] in the [Color Matching] menu. You can adjust color settings such as brightness and saturation.

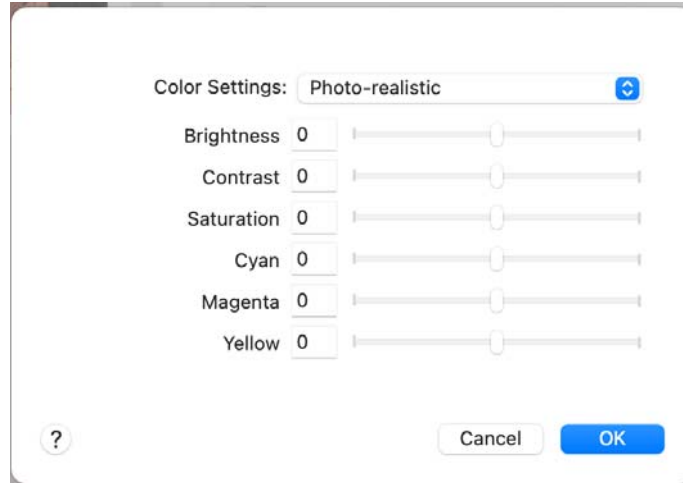

Item	Description	Default
Color Settings	Allows you to change the correction method. For information on color correction, see the link below. "Color Correction" on page 273	Epson Preferred Color
Brightness	Allows you to adjust brightness. It can be set in the range of -25 to 25.	0
Contrast	Allows you to adjust contrast. It can be set in the range of -25 to 25.	0
Saturation	Allows you to adjust saturation. It can be set in the range of -25 to 25.	0
Cyan	Allows you to set a correction value for cyan. It can be set in the range of -25 to 25.	0
Magenta	Allows you to set a correction value for magenta. It can be set in the range of -25 to 25.	0
Yellow	Allows you to set a correction value for yellow. It can be set in the range of -25 to 25.	0

3 Extension Settings

Auto cut setting, buzzer setting, and pause setting can be set.

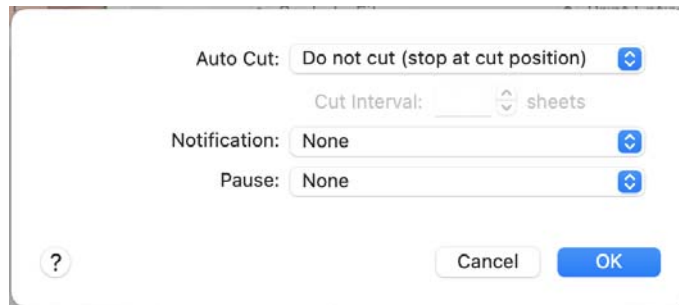

Item	Description	Default
Auto Cut	Select whether and when to operate the auto cutter.	Do not cut (stop at cut position)
Cut Interval	If you select [Cut (at specified label)] in [Auto cut], set how many labels to print before cutting. It can be set in the range of 1 to 999.	1
Notification	Set the timing for the buzzer to sound.	None
Pause	Set the timing to pause the printer during printing.	None





The initial setting for [Auto Cut], [Notification], and [Pause] of the driver can be changed by the following procedure.

1. From the Apple menu, select System Preferences - Printers & Scanners.
2. Select the printer, and then click [Options & Supplies] - [Option].
3. Change the setting.

4 Extension Settings 2

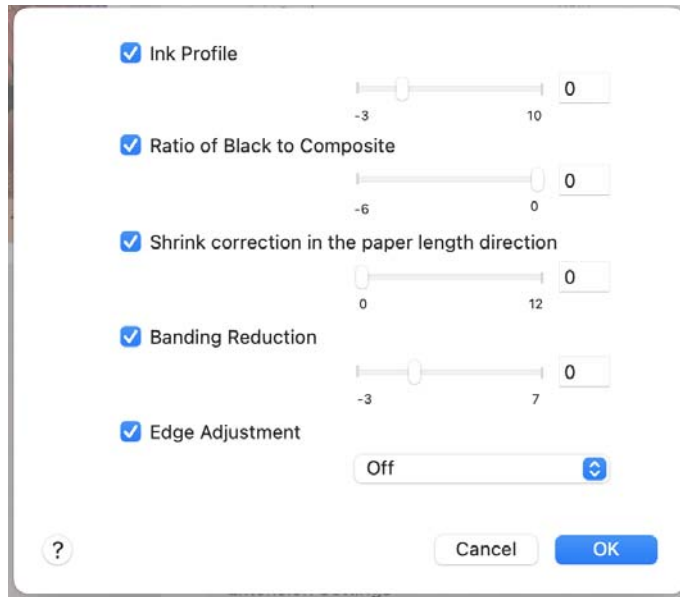
You can set the ink profile, black ratio, shrinkage correction, banding reduction, and edge correction.



CAUTION  If you print without selecting the check boxes for these items, the printer will print according to the settings configured on the printer. The gray out settings shown on the driver screen are not showing the actual settings, but they are default settings of the printer driver.

Item	Description	Default
Ink Profile	Allows you to adjust the ink density. It can be set in the range of -3 to 10.	0
Ratio of Black to Composite	Allows you to adjust the ratio of black ink to composite black. It can be set in the range of -6 to 0.	0
Shrink correction in the paper length direction	If the print result shrinks in the paper length direction, set the correction value. It can be set in the range of 0 to 12.	0
Banding Reduction	Allows you adjust the ink density to reduce color banding on printouts. It can be set in the range of -3 to 7.	0
Edge Adjustment	If a slight gap occurs between the background color and the text, enabling [Edge Adjustment] may make the gap less noticeable.	Off



- If you increase the ratio of black ink, be careful not to touch the label surface immediately after printing because ink can adhere to your fingers.
- If the paper type is high glossy paper or glossy film, the [Banding Reduction] function may not be able to reduce color banding so much. Please examine print quality with the paper well before using it.

8 Check the print settings, and then click [Print] to start printing.

Selecting the Dedicated Printer Driver

If the menus described in "Basic Procedure for Printing" are not displayed, select the printer driver dedicate for this printer in [Printer]. The dedicated printer driver is displayed as follows.

- When connecting via USB
EPSON CW-C8XXXX
- When connecting via a network
EPSON CW-C8XXXX-YYYYYY
"XXXX" is the product model number. "YYYYYY" is the last six digits of the MAC address.



Depending on the OS version, the MAC address may not be displayed even when the printer is connected via a network.

If the dedicated printer driver is not displayed in the list, add it following the procedure below.

- 1** From the Apple menu, select [System Preferences] - [Printers & Scanners].
- 2** Click [+] and select [Add Printer or Scanner].
- 3** When the list of devices appears, select the dedicated printer driver and then click [Add].

Customizing the Printer Driver

You can save frequently used sets of settings (paper size and other print settings) as Presets under a new name. This allows you to easily apply exactly the same settings repeatedly.

Saving Settings as Preset

- 1 Make the paper size and other print settings to save them as a preset.
- 2 From the [Presets] menu, select [Save Current Settings as Preset].

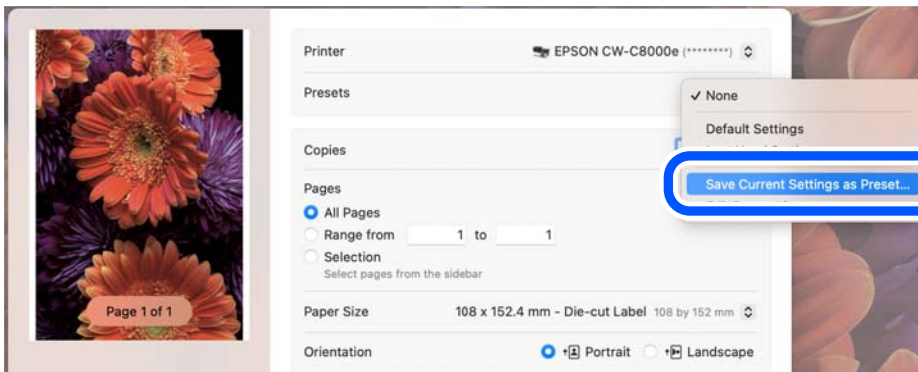

If you want the preset you last used to be selected the next time you print, open [Show Presets...] and make sure that the check box for [Reset Presets Menu to "Default Settings" After Printing] is not selected.

- 3 Enter a name, and then click [OK].

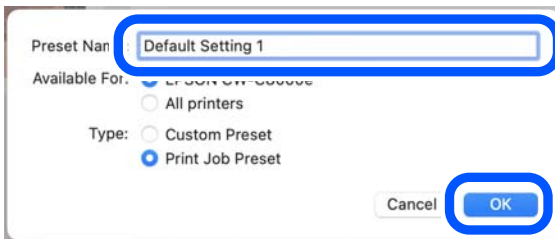

Select [All printers] in [Preset Available For] to allow selection of the preset from all printer drivers installed on your computer.

The set of settings is saved in [Presets]. You can select it from the [Presets] menu from the next time.

Deleting from Presets

- 1 Click [Edit Preset List...] in [Presets] of the Print dialog box.

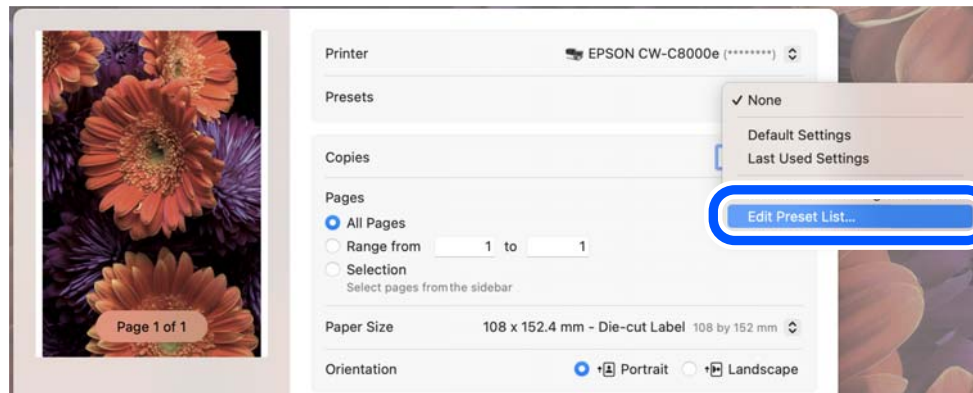

- 2 Select the preset you want to delete, click [-], and then click [OK].

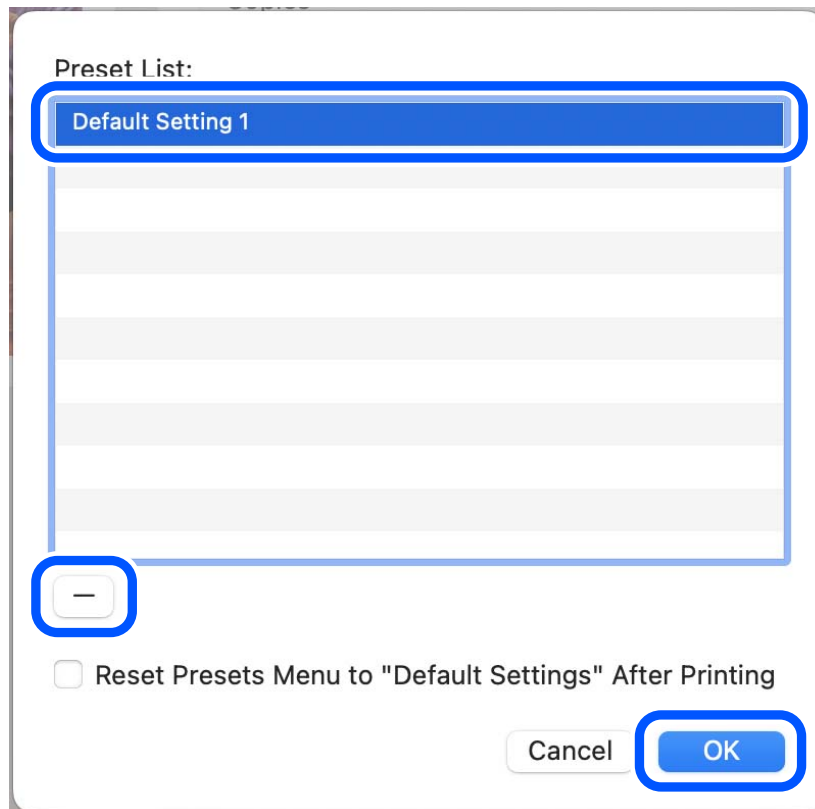

Epson Label Printer Utility

Epson Label Printer Utility allows you to start EPSON Status Monitor, to perform [Nozzle Check], [Print Head Cleaning], [Power Cleaning], or [Adjust Uneven Colors]. In addition, the [Media Setting], [Positioning], [Settings for Paper Handling After Print], and [Printer Settings] menus allow you to change those settings of the printer from the computer.

- 1 From the Apple menu, select [System Preferences] - [Printers & Scanners], and then select the dedicated printer driver for this printer.
- 2 Click [Options & Supplies] - [Utility] - [Open Printer Utility].

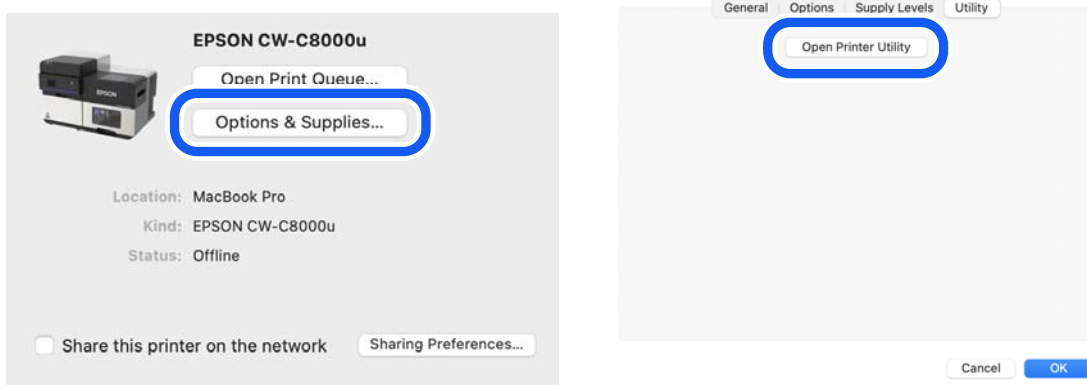

- 3 **Epson Label Printer Utility starts.**

Click an icon for the function you want to use. The function window appears. For more details, follow the instructions displayed on the window.

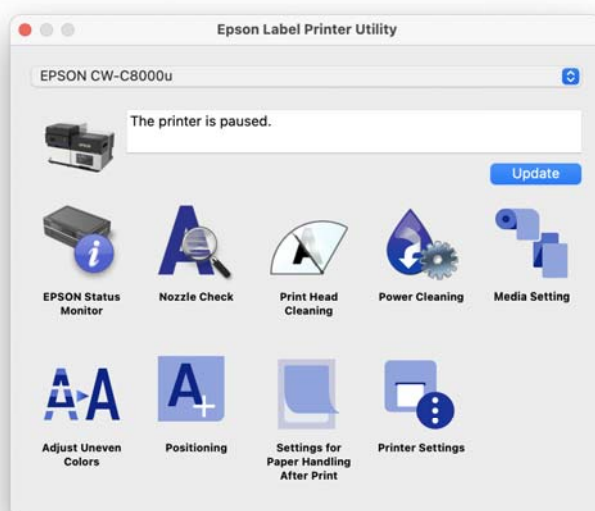

Changing the Paper Source Setting

To change the paper source setting (internal roll or external feed), select [Media Setting] of the Epson Label Printer Utility and change the [Media source] setting.

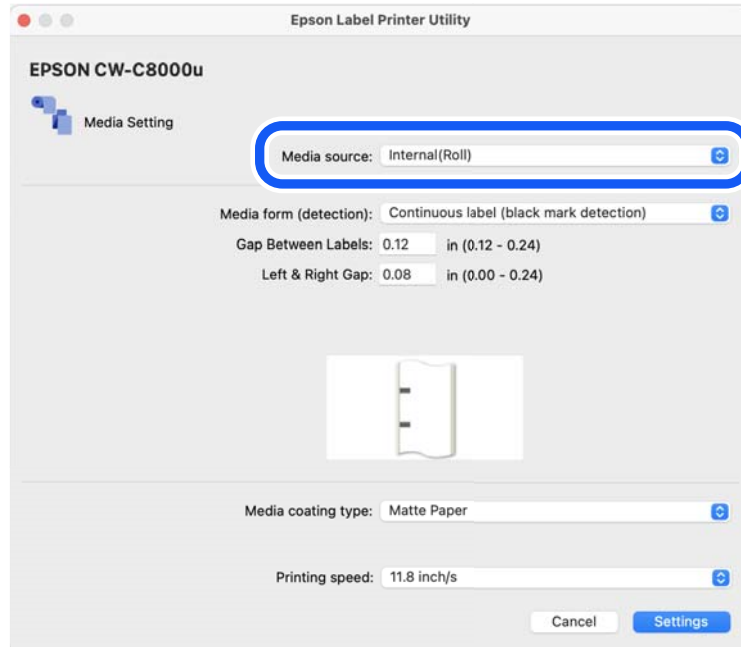

Printer Driver for Linux

This section describes how to install the printer driver and how to configure Epson Label Printer Utility for Linux. You can start EPSON Status Monitor, run a nozzle check and print head cleaning, make paper and other settings using Epson Label Printer Utility for Linux.



About Linux Printer Driver

- Linux driver is not for end-users. It is aimed at system developers or engineers who can build a Linux based system by themselves. To operate the driver, command lines are mainly used. Rich graphical user interface such as the Windows printer driver is not provided.
- It offers minimum functions for printing.
- Basically, the same functions as the Mac printer driver are provided. However, due to limitations of the Linux OS, some of the functions are not available.

The procedure is as follows.

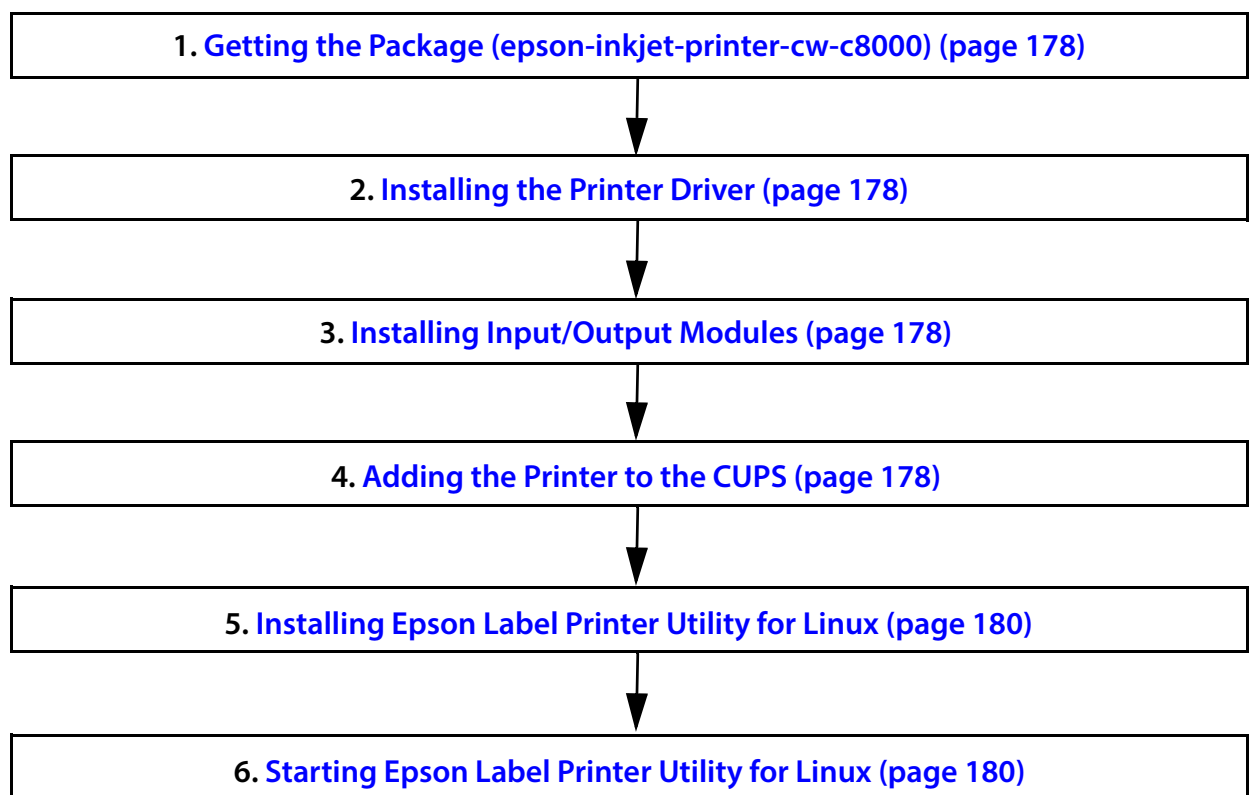

Throughout this section, command strings that follow "\$" can be executed by a login user, and command strings that follow "#" need to be executed with administrator privileges.

Getting the Package (epson-inkjet-printer-cw-c8000)

For details on printer drivers and Epson Label Printer Utility for Linux, please contact your dealer.

Installing the Printer Driver

Start a terminal software, and execute a command shown below.

< Ubuntu 20.04 LTS>

```
# dpkg -i epson-inkjet-printer-cw-c8000_[Arch].deb
```

<CentOS 7>

```
# rpm -i epson-inkjet-printer-cw-c8000_[Arch].rpm
```

Installing Input/Output Modules

Execute a command shown below.

1.3.0 indicates version of the software. Correct it according to the file you use.

< Ubuntu 20.04 LTS>

```
# dpkg -i epson-printer-io-community-1.3.0.deb
```

< CentOS 7>

```
# rpm -i epson-printer-io-community-1.3.0.rpm
```

Adding the Printer to the CUPS

The following is the procedure using a web browser.

- 1 **Access the address below.**
<http://localhost:631/>

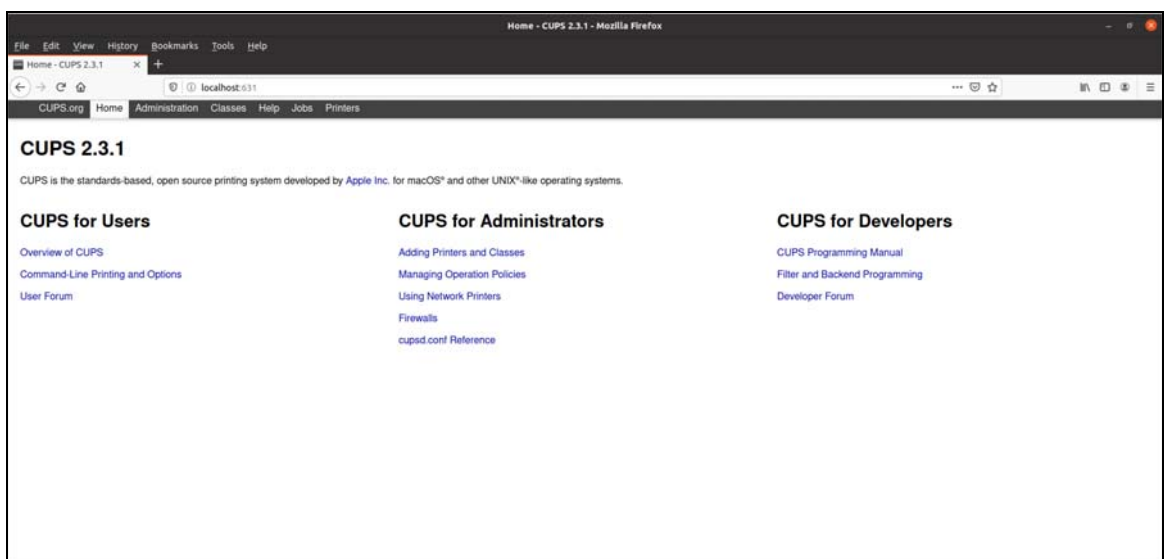

2 Select the [Administration] tab, and then select [Add Printer].

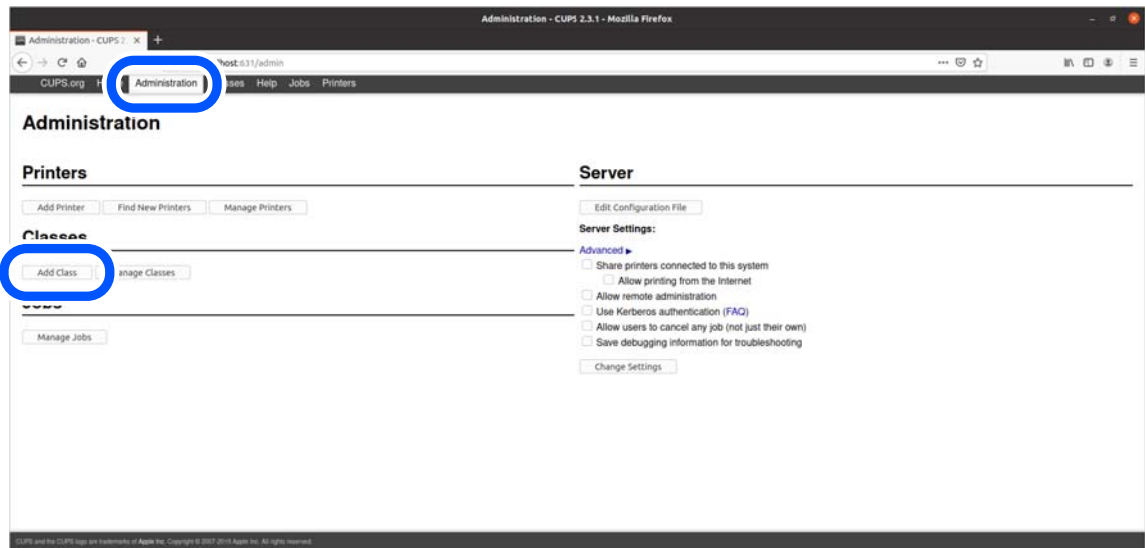

Follow the on-screen instructions. If you are prompted to enter a user name and password, enter “root” as a user name and enter an administrative password.

3 When a list of printers is displayed, select the printer to add.

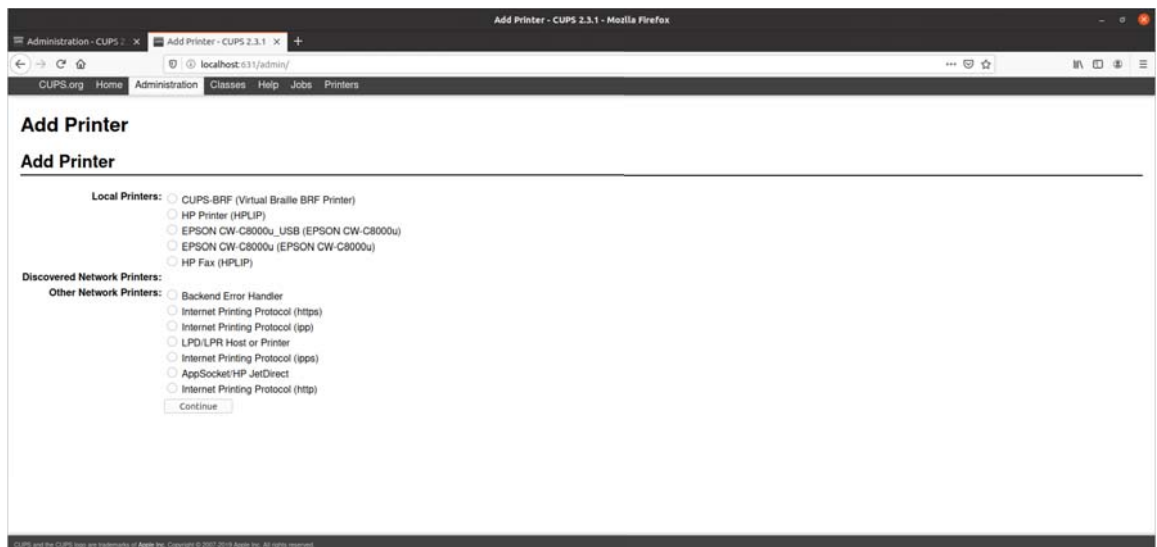

Select the [Printers] tab to see the information of the added printer.

For USB connection

If the printer is connected to the computer using a USB cable, select the printer as described below.

In the list of printers, select the printer that is indicated with its model name followed by “_USB” (1).

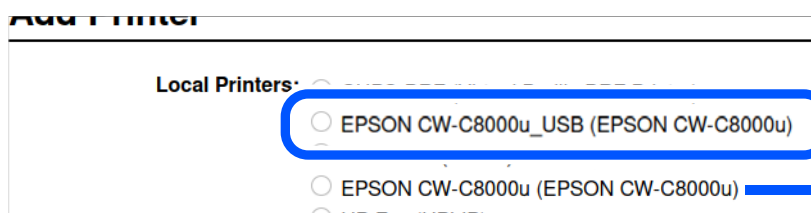

- (1) Communication module
for EPSON product
(2) CUPS standard

Installing Epson Label Printer Utility for Linux

Execute a command shown below.

1.3.0 indicates version of the software. Correct it according to the file you use.

< Ubuntu 20.04 LTS>

```
# dpkg -i epson-label-printer-utility-community-1.3.0-QT5.deb
```

< CentOS 7>

```
# rpm -i epson-label-printer-utility-community-1.3.0-QT5.rpm
```

Starting Epson Label Printer Utility for Linux

Epson Label Printer Utility for Linux can be started either from a command line or from Desktop Entry.

Use one of the following methods to start the utility.

Starting from a command line

Execute a command shown below.

<Common to both Ubuntu and CentOS>

```
$ /opt/epson/epson-label-printer-utility/elpuqt &
```

Starting from Desktop Entry

The operation method may vary by distribution, edition, flavors, and version.

The following explains how to start the utility on Ubuntu 20.04 and CentOS 7.

<Ubuntu 20.04 LTS>

Click the icon in the bottom left of the screen, and then select Epson Label Printer Utility in the displayed list. If the utility is not displayed, search for “Epson” to find it.

<CentOS 7>

From the application menu located in the upper left of the screen, select the “Accessories” sub menu. Select Epson Label Printer Utility from the displayed list.

Epson Label Printer Utility for Linux will start.

Click an icon to display the function screen. For details, see the descriptions shown on the function screen.

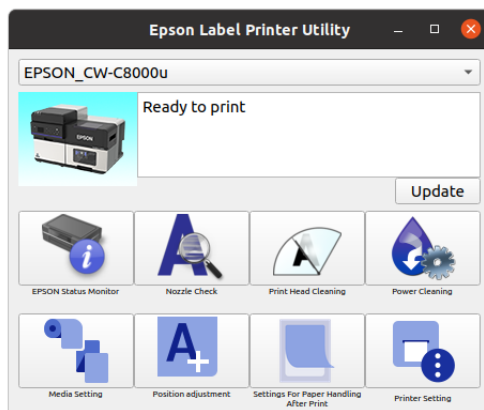

Installing Dependent Libraries

If you are using supported distribution and have not changed the default settings, installing dependent libraries is not necessary. If you have not installed default full package, Epson Label Printer Utility for Linux may not work due to lack of dependent libraries.

The dependent libraries and the required package are as follows.

Dependent file	Dependent package (Ubuntu 20.04 LTS)	Dependent package (CentOS 7)
libQtCore.so.5	libqt5core5a	qt5-qtbase
qt5-qtbase	libqt5gui5	qt5-qtbase-gui
libQtWidgets.so.5	libqt5widgets5	
libcups.so.2	libcups2	libcups2
libcupsimage.so.2	libcupsimage2	
libpng15.so.15	(Not used)	libpng15
libpng16.so.16	libpng16-16	(Not used)
libusb-1.0	libusb-1.0-0	libusb

If an error occurs due to lack of dependent libraries when starting Epson Label Printer Utility for Linux, install the necessary file.

Example: Qt5 is not found on Ubuntu 20.04 LTS

Execute a command shown below.

```
# apt install libqt5widgets5
```

Exiting Epson Label Printer Utility for Linux

Use one of the following methods to exit the utility.

- Click “X” on the screen.
- Press [Alt] and [F4] at the same time.
- Click [Exit Epson Label Printer Utility].

Uninstalling Printer Driver, Epson Label Printer Utility for Linux

❑ Printer driver

Start a terminal software, and execute a command shown below.

```
< Ubuntu 20.04 LTS>
```

```
# dpkg -P epson-inkjet-printer-cw-c8000
```

```
< CentOS 7>
```

```
# rpm -e epson-inkjet-printer-cw-c8000
```

❑ Epson Label Printer Utility for Linux

Start a terminal software, and execute a command shown below.

```
< Ubuntu 20.04 LTS>
```

```
# dpkg -P epson-label-printer-utility-community
```

```
# dpkg -P epson-printer-io-community
```

```
< CentOS 7>
```

```
# rpm -e epson-label-printer-utility-community
```

```
# rpm -e epson-printer-io-community
```



Printing from SAP System

CW-C8000 Series allow you to print from a SAP system which is one of Enterprise Resource Planning systems.

Methods of Printing from SAP System

There are the following three methods to print from SAP System.

To know the data flow and component of each methods, see ["SAP System Printing Data Flow" on page 183](#).

Printing Method	Overview
Direct printing  "Direct Printing" on page 184	<p>This is a standard method for printing from SAP System. Printing operation is completed in the closed SAP system environment, where basically only programs provided by SAP company are used. Printer driver provided by the system as a SAP standard printer driver is used. Since this Direct printing system is highly reliable and stable, it is generally used for remote batch high-volume printing.</p> <p>Printer vendors are required to provide only a file called "Device type" which describes ability of their printer. However, if the printer uses a printer control language that is not supported by the SAP printer driver, the vendor is also required to provide ABAP driver. ABAP driver converts the printer control language supported by the SAP printer driver into the language supported by the printer.</p>
Indirect printing  "Indirect Printing" on page 184	<p>Printing operation is completed through a Windows computer located outside the SAP system.</p> <p>Sprint or SAP LPD software provided by SAP company installed on the Windows computer receives print data from the SAP system, converts the data into Windows print system format, and then prints the data by sending it to a Windows printer driver provided by the printer vendor. Therefore, this method allows you to print on various Windows compatible printers. However, because of using software located outside the SAP system, frequency of problem may increase or printing speed may decrease compared to Direct printing.</p>
High Volume Printing  "High Volume Printing" on page 184	<p>This method is for printing GHS labels that contain color pictograms. The data is sent from EHS (Environment, Health and Safety Management) and GLM (Global Label Management) and printed through WWI (Windows Word processor Integration) Server.</p> <p>HVP driver provided by SAP company is used, and for specifying the target printer, plug-in provided by the printer vendor is used. The amount of data for printing is smaller than that for normal Windows printer driver.</p>

SAP System Printing Data Flow

The flowchart below shows the data flow and component of each printing methods.

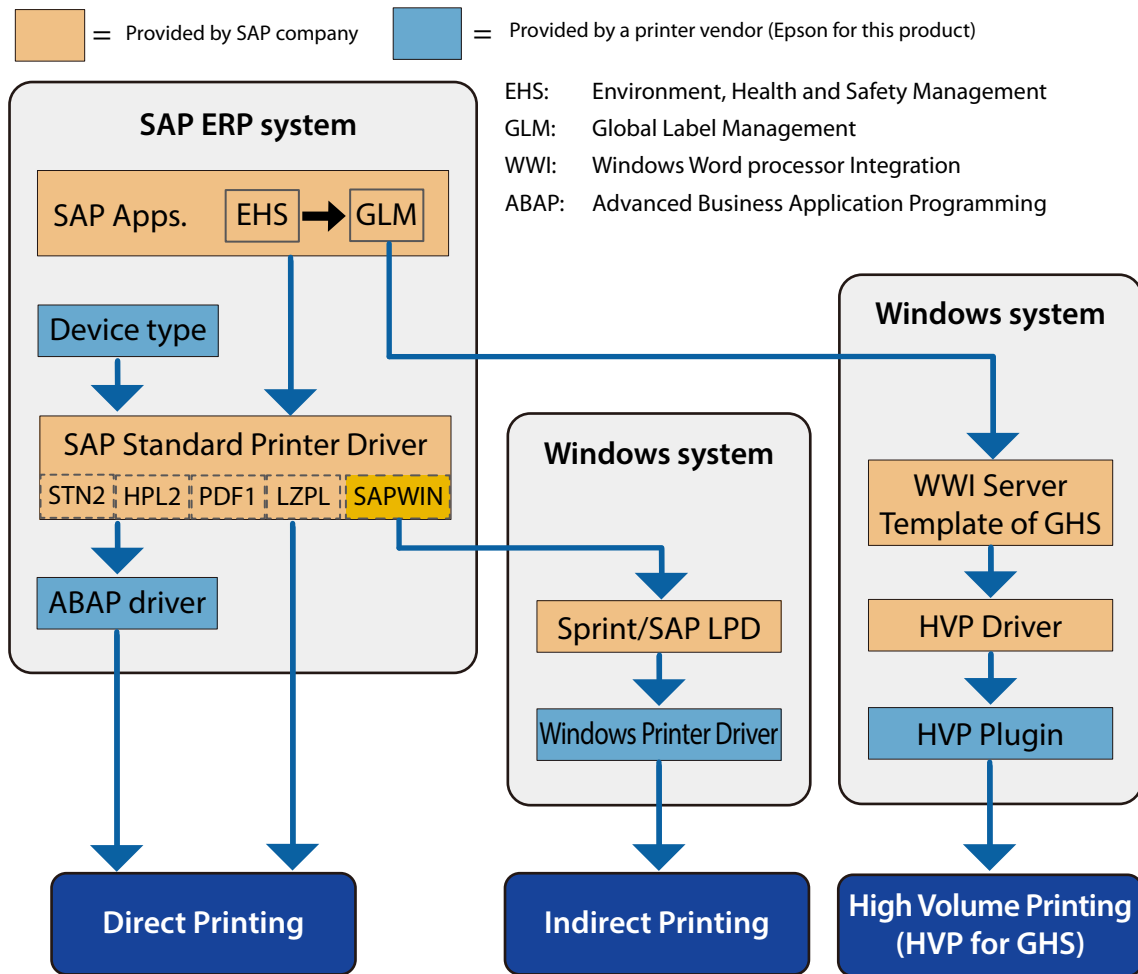

The SAP Standard Printer Driver used for Direct printing supports the following printer control languages.

Name	Supported Printer Control Languages
STN2	Line Printer Driver 2
HPL2	HP PCL5
LZPL	Zebra ZPL2
PDF1	Adobe PDF
POST2	Adobe PostScript
ESCPAG	EPSON ESC/Page
PRES	Kyocera PRESCRIBE

Direct Printing

Because this method uses the SAP standard printer driver and completes printing operation in the closed SAP system environment, Epson cannot provide any information about how to use the system. Consult information provided by SAP company*.

This section explains about files provided by Epson that is necessary for Direct printing using CW-C8000 Series, and installation method.

- * The method for printing from the SAP system is common to all printers regardless of difference of vendor. SAP Note that describes all necessary information is public to all SAP users. A SAP user account is required to acquire the SAP Note.

Necessary Files

Device type

Use one of the following files.

- YEPCW6X.PRI: For languages other than Japanese
- YEPCW6XJ.PRI: For Japanese

ABAP driver

The driver consists of the following two files. Use the two files as a pair.

- K00XXXX.PVD
- R00XXXX.PVD



The printer control language for CW-C8000 Series is ESC/Label. Since the SAP printer driver does not support the language, both the Device type and the ABAP driver are required. For information about printer control languages supported by the SAP printer driver, see "[SAP System Printing Data Flow](#)" on page 183.

How to Install

For instructions on how to install the printer files, see the following SAP Note.

- SAP Note 2867759
- SAP Note 1103422

SAP web site URL: <https://launchpad.support.sap.com>

Indirect Printing

Install the latest Epson Windows printer driver on a Windows computer for using this method.

For instructions on how to use the driver, see "[Printer driver for Windows](#)" on page 91.

For instructions on how to install and use the SAP software, Sprint or SAP LPD, follow the instructions provided by SAP company.

High Volume Printing

This method uses HVP driver provided by SAP company. Epson provides a plug-in file for the HVP driver.

For instructions on how to perform high volume printing, see "CW-C8000 Series HVP Plug in Module User's Guide" that comes with the plug-in.

PrinterSetting (Windows)



You may not be able to change the settings while the printer driver or other software is communicating with the printer.

PrinterSetting is a utility that can run on Windows OS and allows you to configure the printer settings. The following shows a summary of available settings with PrinterSetting.

Item	Description	Page
Media settings*	Allows you to make settings of paper to be used on the printer.	Page 188
Layout settings*	Allows you to make paper layout settings. User-defined layout settings that include paper form and print area setting can be configured.	Page 189
Position adjustment	Allows you to adjust print start position and cut position.	Page 191
Print results adjustment*	Allows you to adjust colors and barcode.	Page 193
Store data in the printer	Allows you to register images, templates, and fonts to the printer. In addition, a character code can be selected from the character code table.	Page 194
Background image settings*	Allows you to configure a background image.	Page 198
Print head maintenance	Allows you to run a print head cleaning or nozzle check, and make settings for periodic cleaning.	Page 202
Detailed settings	Allows you to make detailed settings of the printer. <ul style="list-style-type: none"> • Printer settings • Uneven colors adjustment • Panel settings • Operating Time Settings • Nozzle check settings • Advanced settings • Initialize printer 	Page 203 to Page 218
Printer information	Allows you to check the printer settings such as paper settings and layout settings, and the maintenance counter.	Page 219
Settings save and restore	Allows you to save the printer settings and to restore the settings from the saved file.	Page 221
Option	Allows you to change PrinterSetting preferences. A unit of length used in PrinterSetting and start up setting can be changed.	Page 222

* Not displayed if you start PrinterSetting from the printer driver.

How to Start PrinterSetting

Start PrinterSetting by following the steps below.

- 1 Turn the printer on.
- 2 Click [Start] - [EPSON] - [CW-C8000 PrinterSetting].
- 3 The Select printer window appears. Select a search target, and then click [Search].

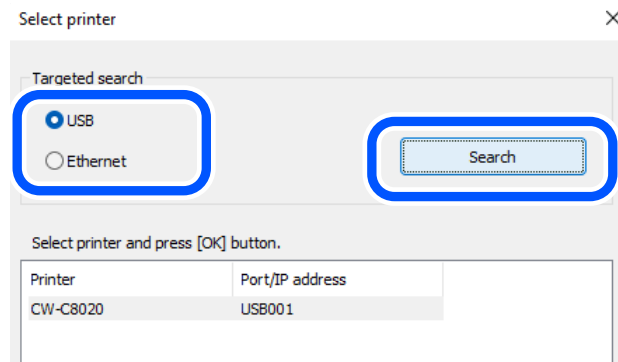

- 4 The printer is displayed in the list. Select the printer, and then click [OK].

 If the printer is connected via Ethernet, the printer may not be displayed in the list. In that case, enter an IP address of the printer.

The screenshot shows the 'Select printer' dialog box with the 'Ethernet' radio button selected. The 'Search' button is visible. Below the table, the 'IP address:' field is highlighted with a blue circle and contains the value '192 . 168 . 192 . 168'. At the bottom, the 'OK', 'Cancel', and 'Help' buttons are visible.

5 PrinterSetting is started.

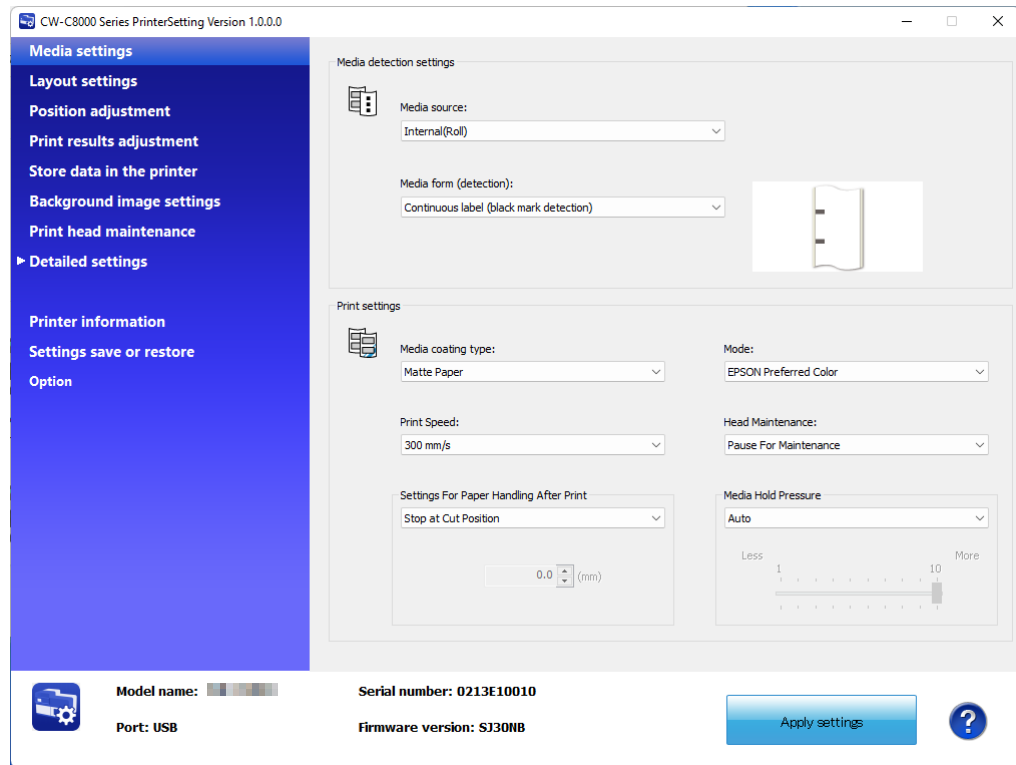

How to Apply Settings

After you change the printer settings, click [Apply settings] to apply the changes to the printer.

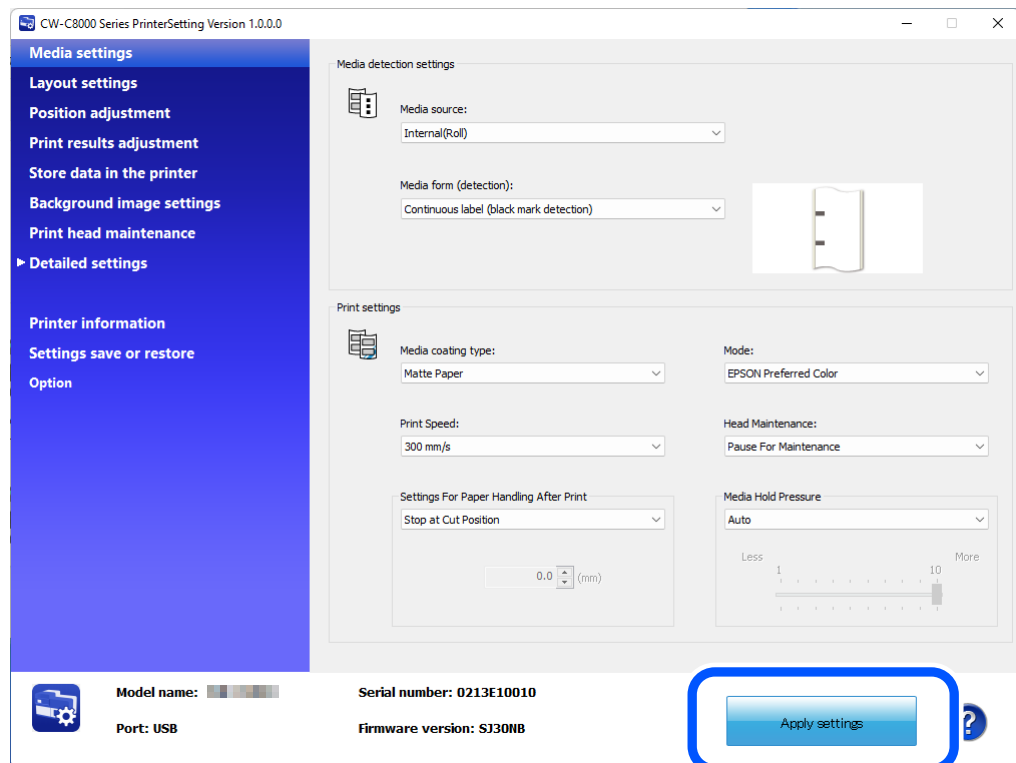

Media settings

Allows you to make settings of paper to be used on the printer.



This is not displayed if you start PrinterSetting from the printer driver.

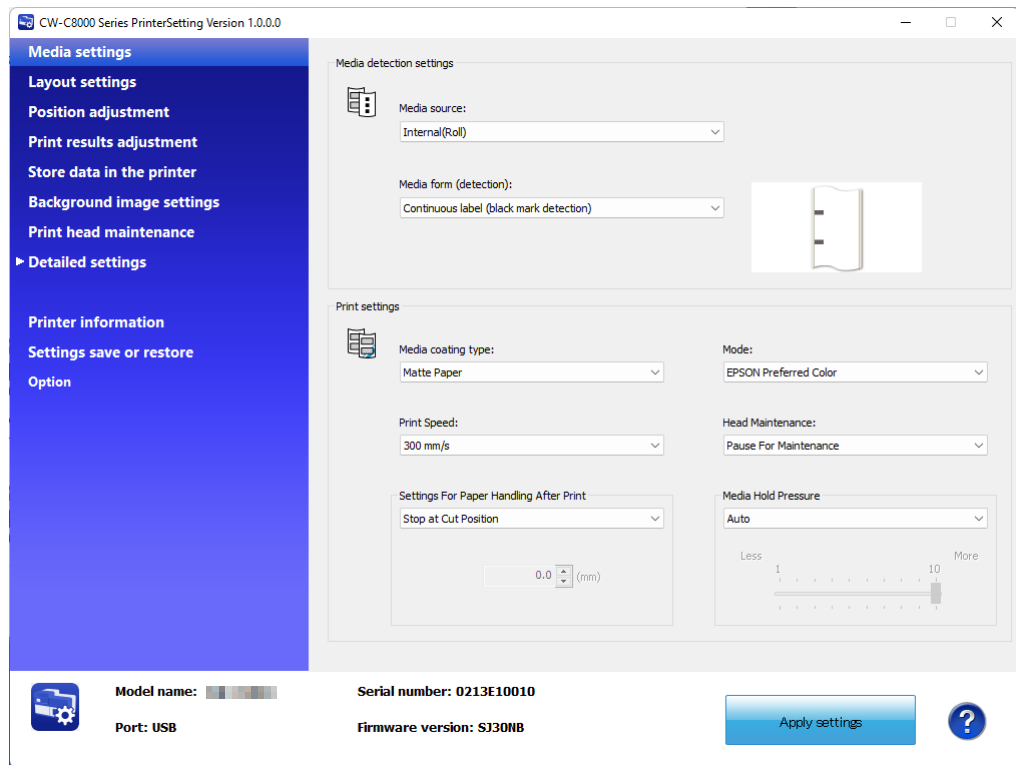

Item		Description
Media detection settings	Media source	Allows you to change the paper feed setting.
	Media form (detection)	Allows you to set paper detection setting.
Print settings	Media coating type	Allows you to select a paper type.
	Mode	Allows you to change the color correction method.
	Print speed	Allows you to select print speed.
	Head Maintenance	Allows you to select the level of flushing operation during printing.
	Settings For Paper Handling After Print	Allows you to set the printer behavior after printing, such as whether to cut paper or not.
	Media Hold Pressure	Allows you to adjust the paper suction power of the platen.

Layout settings

Allows you to change the paper layout settings and create a user-defined layout settings.



This is not displayed if you start PrinterSetting from the printer driver.

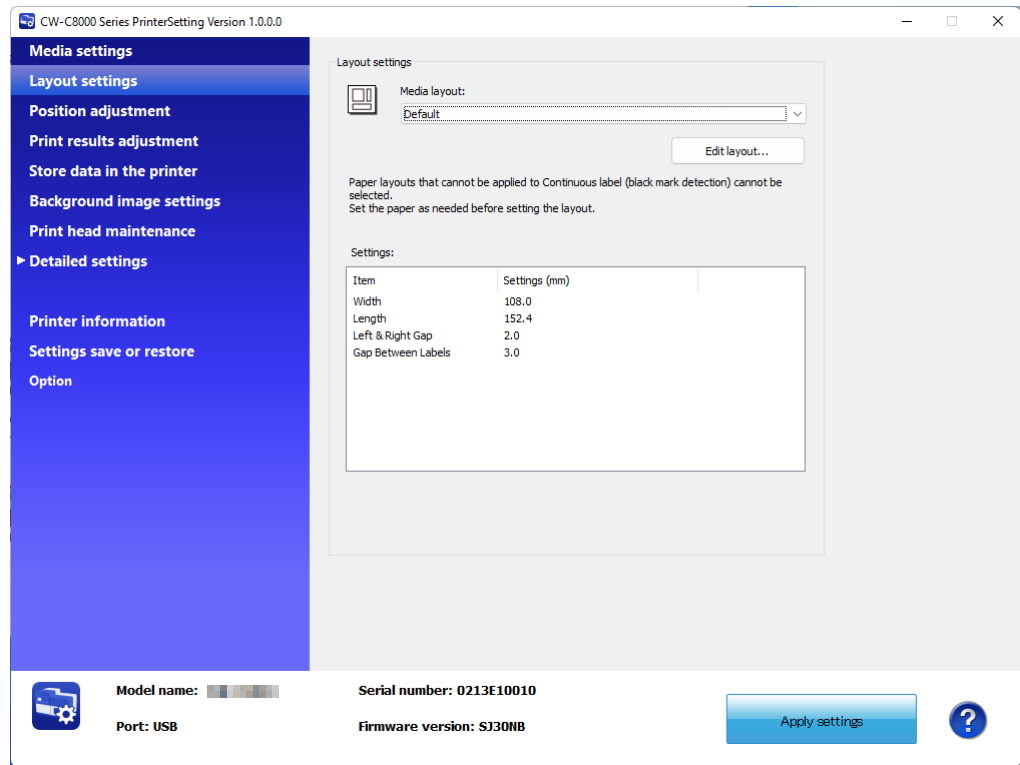

Item		Description
Layout settings	Media layout	Allows you to make paper layout settings.
	Edit layout...	Allows you to create a user-defined layout settings. The Layout settings window appears when you click this.

Editing the layout

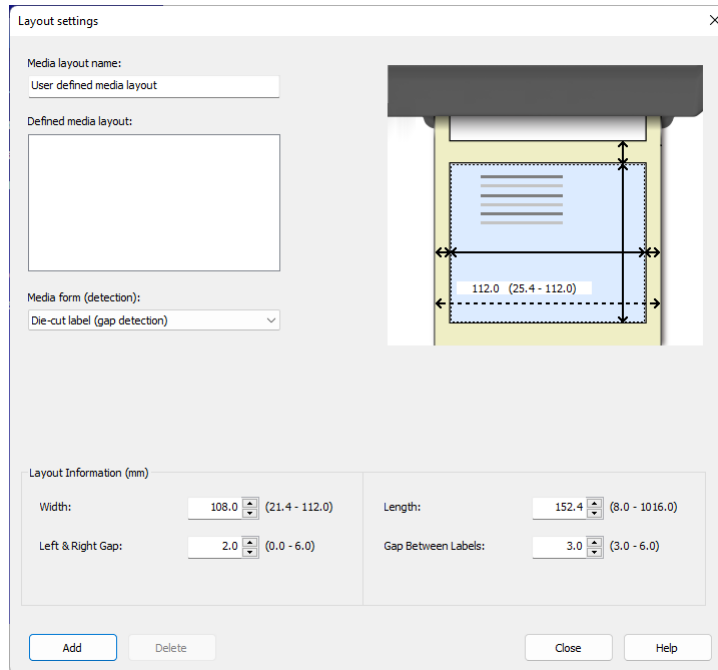

Item	Description
Media layout name	Allows you to set a name for a new paper layout settings. Enter a name to set.
Defined media layout	If one or more sets of user-defined paper layout settings already exist, they are listed here.
Media form (detection)	Allows you to select a media form.
Layout Information	The layout information that can be set changes depending on the [Media form (detection)] setting. Before making this setting, set Media form (detection). <ul style="list-style-type: none"> • When using die-cut label, full-page label, or continuous paper Set the width, length, left and right gaps, and gap between labels. • When using tag Set the hole type, width, length, left gap, right gap, gap between labels, and distance between hole and paper edge.



When label (page) length is long, length of printed image may be shorter than the specified length depending on paper used. It causes an extra margin on the bottom of the label (page) (bottom means rear end in the paper feed direction). If you want to reduce the margin, try the following method.

Step 1: Examine print results on labels.

Step 2: Add the length of the extra margin to [Length] in Layout settings.

Position adjustment

Allows you to adjust print start position and cut position.

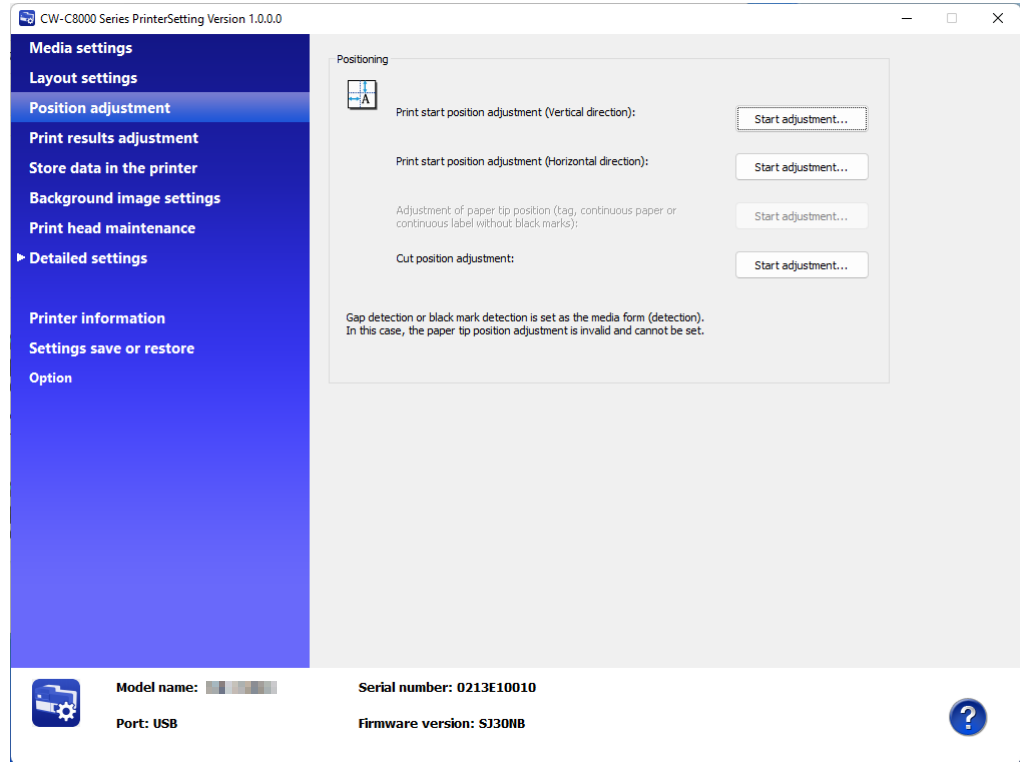

Item		Description
Positioning	Print start position adjustment (Vertical direction)	Allows you to adjust the print start position in the vertical direction. Adjustment procedure "Start adjustment" on page 192
	Print start position adjustment (Horizontal direction)	Allows you to adjust the print start position in the horizontal direction. Adjustment procedure "Start adjustment" on page 192
	Adjustment of paper tip position (For the following paper without black marks; continuous paper, full-page label, and tag)	Allows you to adjust the print start position from the leading edge of a continuous paper or full-page label. Adjustment procedure "Start adjustment" on page 192
	Cut position adjustment	Allows you to adjust the cut position. Adjustment procedure "Start adjustment" on page 192

Start adjustment

The following is the adjustment procedure for "Print start position adjustment (vertical direction)". The procedure is the same for the other adjustments.

- 1 The window shown below appears when you click [Start adjustment].

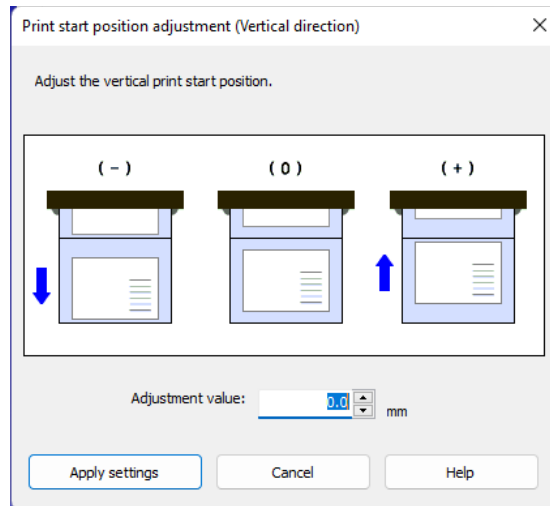

- 2 Enter a value in the [Adjustment value] box, and then click [Apply settings].
- 3 A confirmation window appears. If you click [Yes], the change is applied.

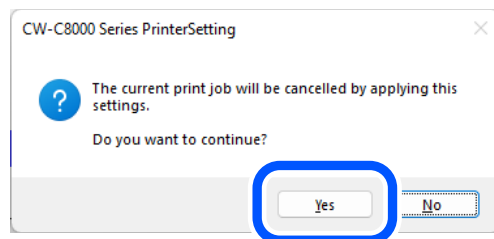

- 4 The result is displayed. Click [OK].
- 5 Print on some labels to check the position is corrected as intended.

Print results adjustment

Allows you to adjust colors and barcode.



This is not displayed if you start PrinterSetting from the printer driver.

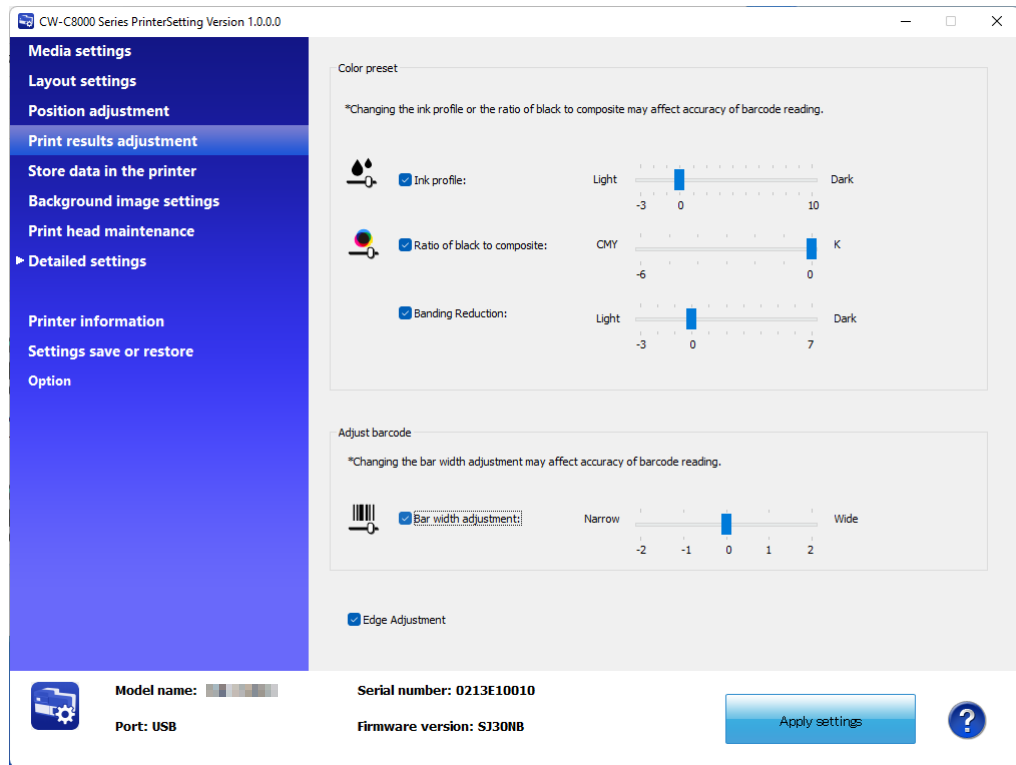

Item		Description
Color preset	Ink profile	Allows you to adjust print density. To ensure print quality, adjust this when you change paper.
	Ratio of black to composite	Allows you to set the ratio of black to composite.
	Banding Reduction	Adjust this to reduce banding when it is noticeable.
Adjust barcode	Bar width adjustment	When using a built-in barcode font, use this to adjust the bar width.
Edge Adjustment		If a slight gap occurs between the background color and the text, enabling [Edge Adjustment] may make the gap less noticeable.



- If you increase the ratio of black ink, be careful not to touch the label surface immediately after printing because ink can adhere to your fingers.
- If the paper type is high glossy paper or glossy film, the [Banding Reduction] function may not be able to reduce color banding so much. Please examine print quality with the paper well before using it.

Store data in the printer

Allows you to register images, templates, fonts, character code tables, and spot colors to the printer.

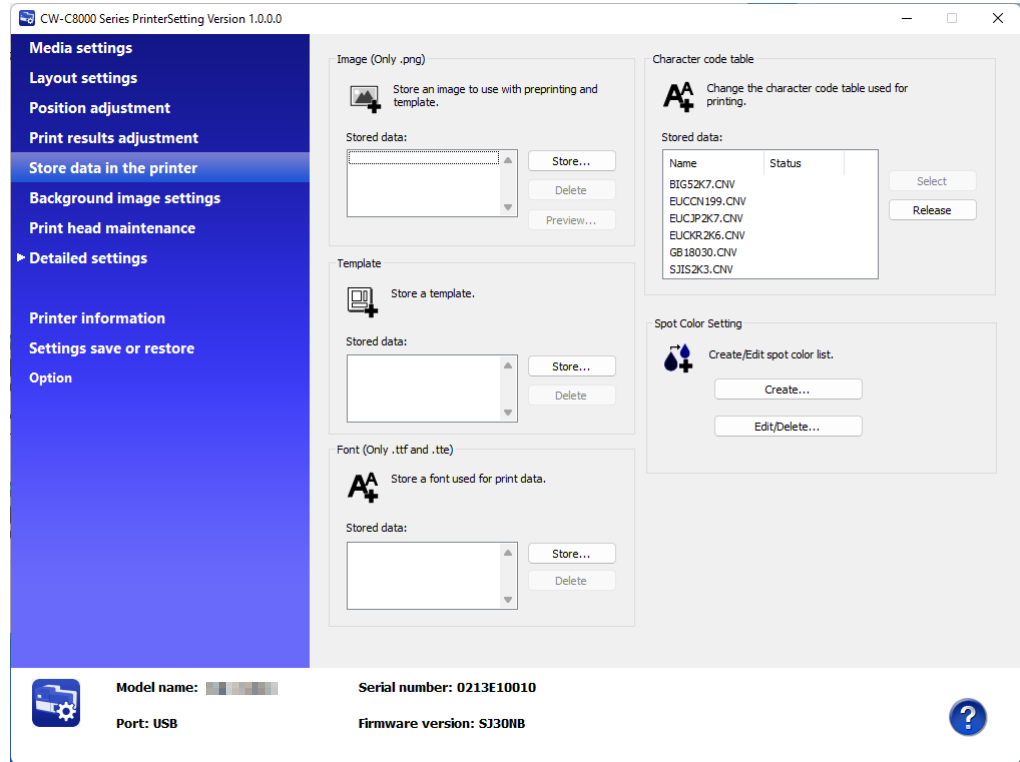

Item	Description
Image (Only .png)	You can register images to be used for preprinting or templates.
Template	Allows you to register templates.
Font (Only .ttf and .tte)	Allows you to register fonts to be used in print data.
Character code table	Allows you to register character code tables to use when printing.
Spot Color Setting	Allows you to create spot color setting files.

Registering Images

You can register frequently used color images to the printer.

Creating a background image

- 1 Prepare an image file in PNG format that has resolution appropriate for printing by the printer.

See "Product Specifications" on page 368.

- 2 Replace an image according to the media size.

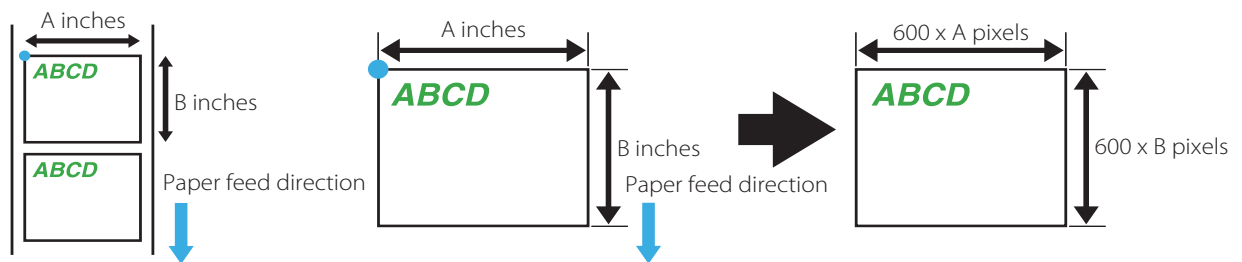

Make sure to match the resolution of the image with print resolution.

- 3 Save the image file in PNG format.

Registering Images

Click [Store...] in the [Image (Only .png)] field to display a screen to select an image.

Specify a png image file to be stored, and then click [Set].

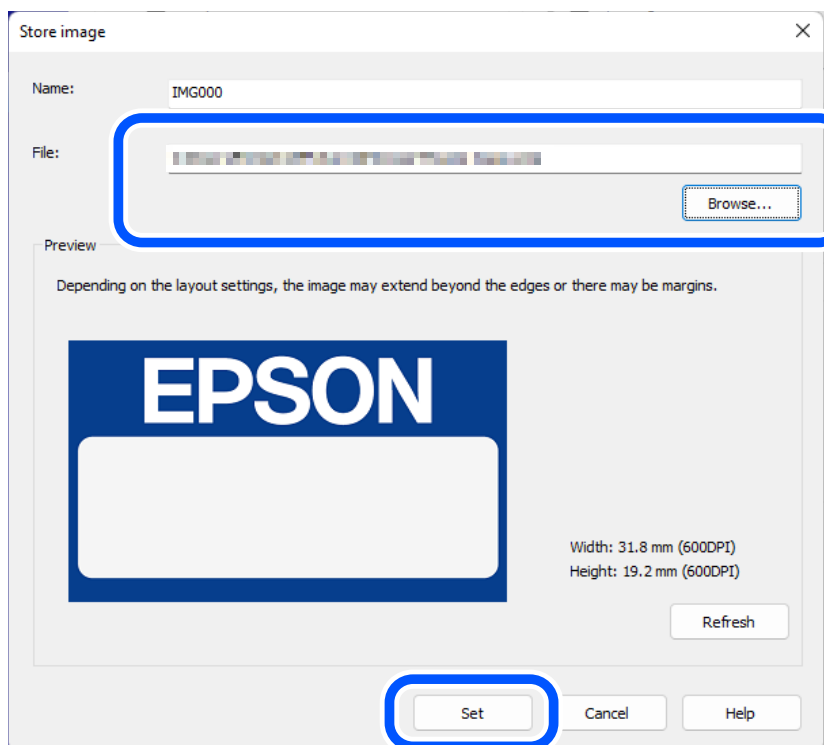

The image file is sent to the printer and stored as a background image.

Registering Templates

The term “template” indicates a standard size label format used by an application that directly controls ESC/Label commands. Registering a template that can be used for your various labels allows your application to generate only data of variable information and print the data combining it with the registered template.

To create a template and to specify the template to print, use the ESC/Label commands.

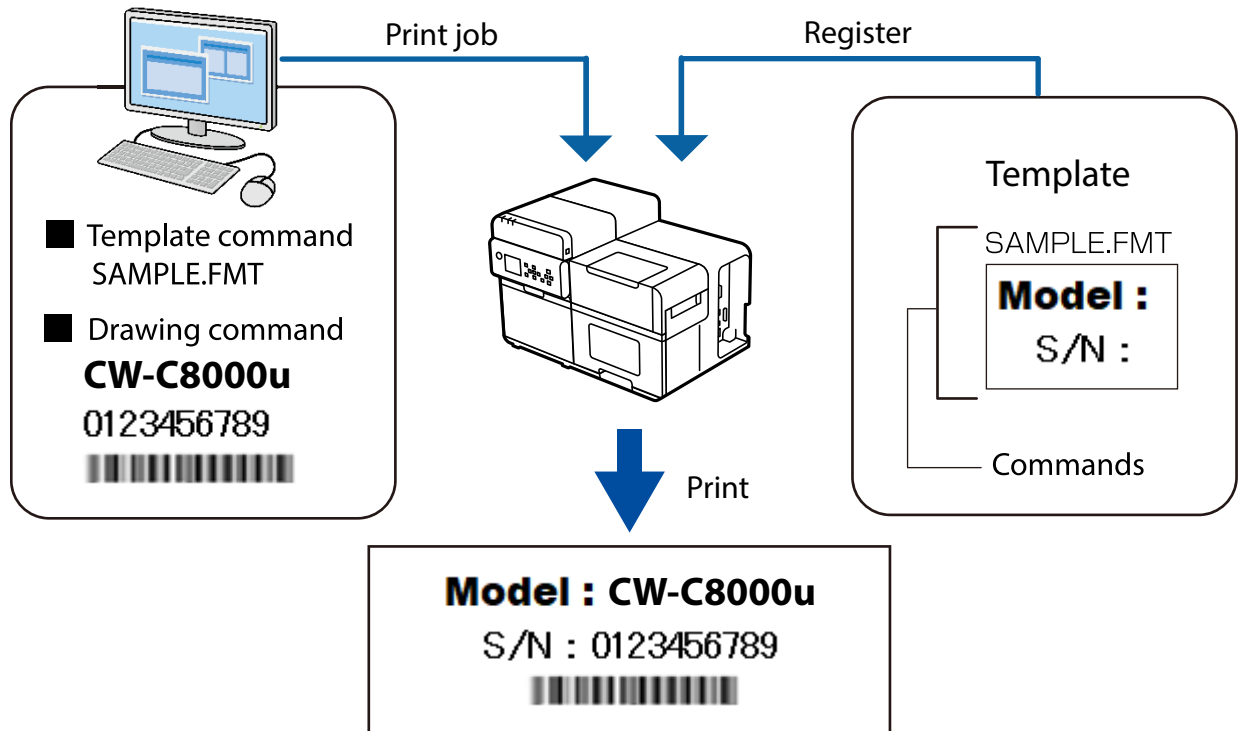

Creating Templates

Using the ESC/Label commands, write label format to be registered on a text or binary file. In the label format description, write the file name of the template file. For more details about the commands, refer to the “Save label format” section in “ESC/Label Command Reference Guide”. There is no prescribed file extension for the text or binary file.

Registering Templates

Click [Store...] in the [Template] field to display a screen to select a template file.

Select the text or binary file that you created as the template file, then click [Set].

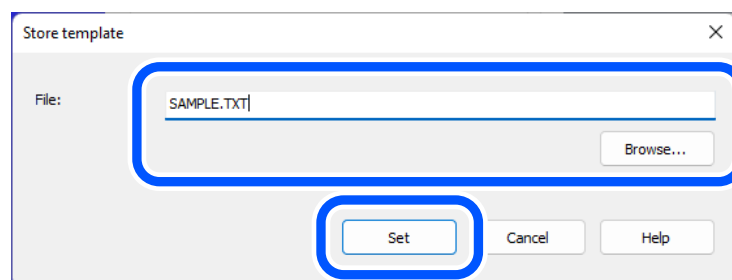

The template file is stored in the printer.

Registering Fonts

Click [Store...] in the [Font (Only .ttf and .tte)] field to display a screen to select a font. Specify the font file (TTF format) to be stored, and then click [Set].

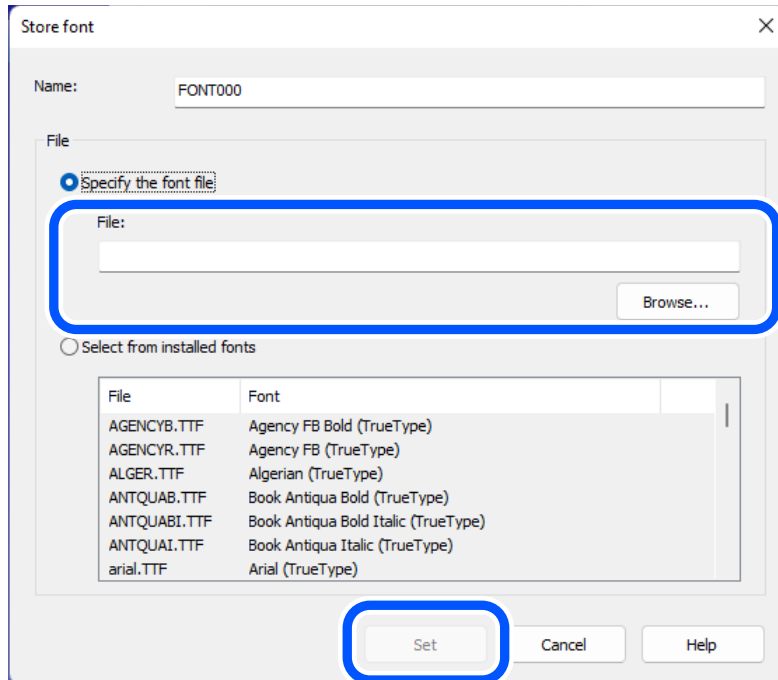

The font file is sent to the printer and stored as a built-in font.

Setting Character Code Table

To print characters under the direct control of ESC/Label commands, you need to set character code table that corresponds to the character code you use.

Select a character code in the [Stored data:] box in the [Character code table] field, and then click [Select].

Character code	Target main country/language	Character code table
BIG5	Taiwan/Hong Kong/Macau	BIG52K7.CNV
EUC-CN	Mainland China (Simplified Chinese)	EUCCN199.CNV
EUC-JP	Japan	EUCJP2K7.CNV
KS X 1001(KS-C 5601-1987)	Korea	EUCKR2K6.CNV
GB18030	Mainland China (Simplified Chinese)	GB18030.CNV
Shift-JIS	Japan	SJIS2K3.CNV



If you have replaced from a ZPL II compatible monochrome printer, a character code that CW-C8000 Series do not support may be specified and the specified character code table may not be applied. In such case, select [Advanced settings] from the [Detailed settings] menus, then select [Fix character code table] in the [Replace settings from printer using ZPL II commands] window. For details, see ["Replace Settings from Printer using ZPL II Commands" on page 211](#).

Background image settings

Allows you to configure a background image.



- Use this function when using the following software.
 - Windows driver from Zebra Technologies Corporation
 - A commercially available label printing application that supports this printer
 - An application that directly controls ZPL II or ESC/Label commands
- This is not displayed if you start PrinterSetting from the printer driver.

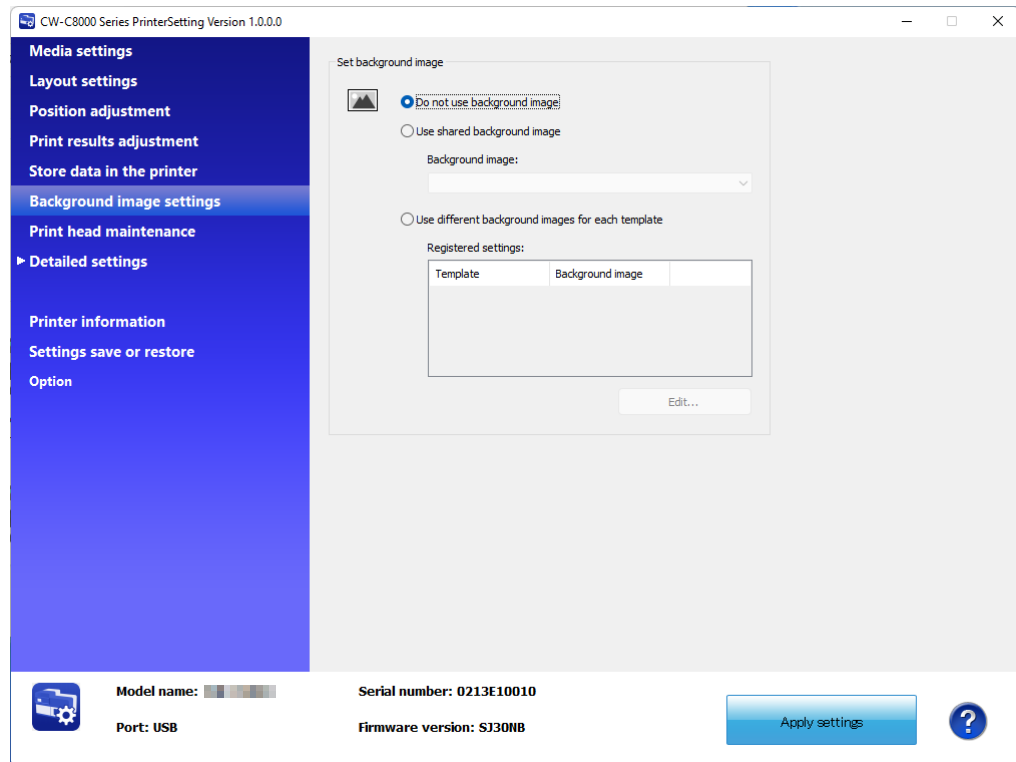

Item		Description
Set background image	Do not use background image	Select this when you do not want to print a background image.
	Use shared background image	The specified image is printed as a background image in normal printing mode. If you print using a template, the image is not printed.
	Use different background images for each template	If you print using a template, the image specified for the selected template is printed. If you do not use a template, the image is not printed. "Linking the Image and the Template" on page 200

Printing the background image

The background image is printed with the following software.

- Windows driver from Zebra Technologies Corporation
- A commercially available label printing application that supports this printer
- An application that directly controls ZPL II or ESC/Label commands



The Epson printer driver does not support printing a background image.

Linking the Image and the Template

CW-C8000 Series allows you to link an image to a template so that the image is printed being overlaid on the template automatically when the template is specified by an application.

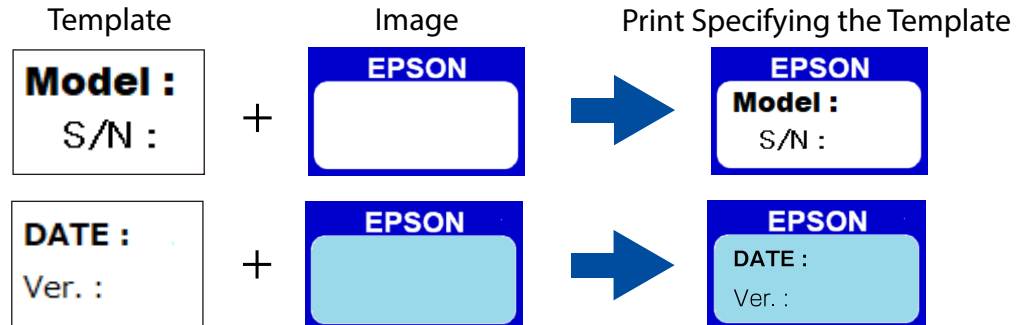

First store the image and the template data in the printer, and then make the link setting.

Store the image data: ["Registering Images" on page 195](#)

Store the template data: ["Registering Templates" on page 196](#)

When you have finished storing the data, make the link setting.

In the [Set background image] field, select [Use different background images for each template], and then click [Edit].

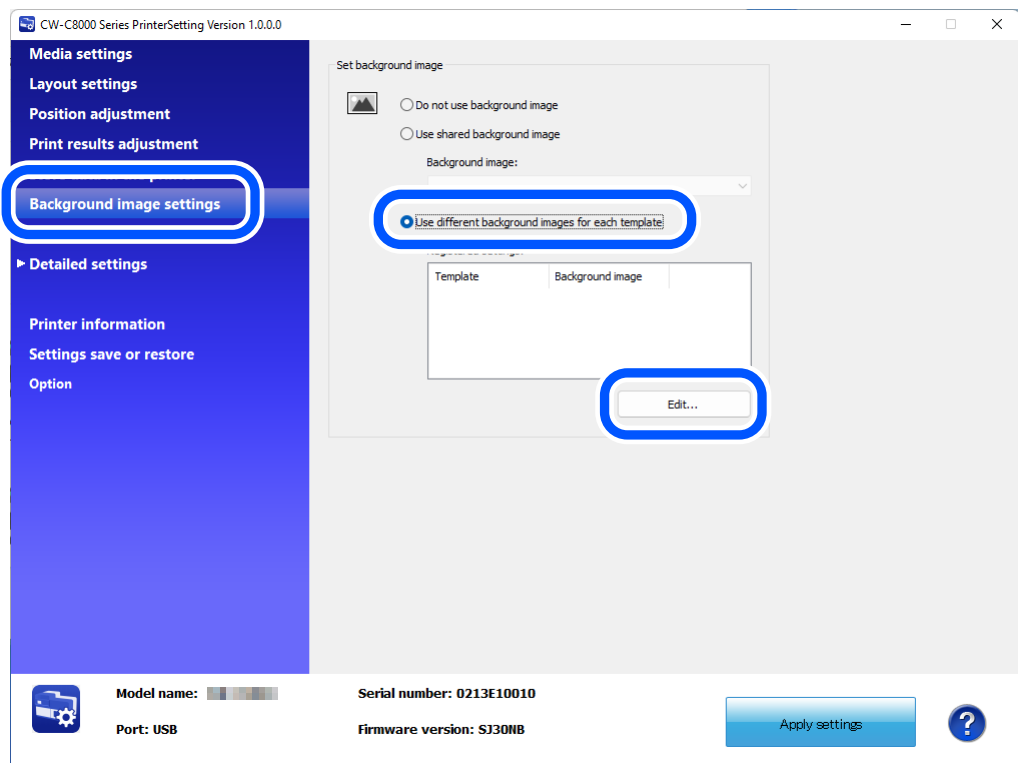

In the [Use different background images for each template] window, select a template and an image to be linked to the template, and then click [OK]. The link setting is set to the printer.

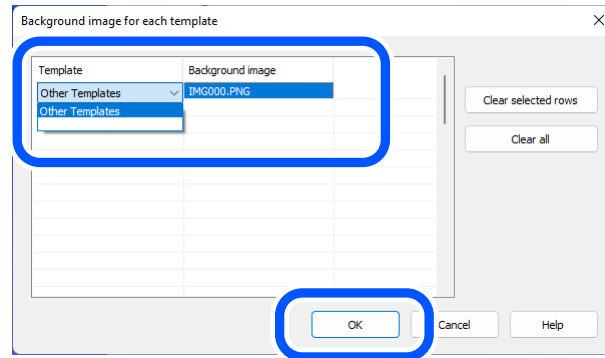

Print head maintenance

Allows you to run a print head cleaning or nozzle check, and make settings for periodic cleaning.

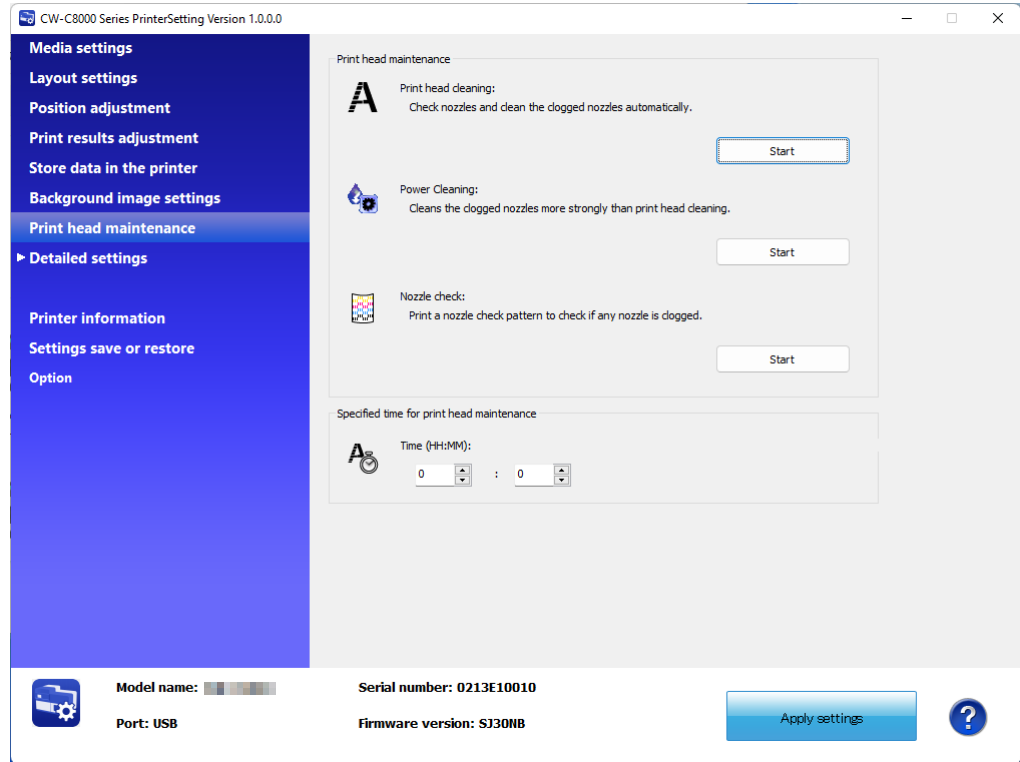



Item		Description
Print head maintenance	Print head cleaning	Runs a nozzle check and clears nozzle clogging. Click [Start] to run the cleaning.
	Power Cleaning	Clears nozzle clogging by running a cleaning that is more powerful than [Print head cleaning]. Click [Start] to run the cleaning.
	Nozzle check	The nozzle check patterns are printed to allow you to check print nozzles for clogging. Click [Start] to print the nozzle check pattern.
Specified time for print head maintenance		Allows you to set a time for running the cleaning. Specify the time in the [Time (HH:MM)] entry box. For details, see " Periodic Auto Cleaning " on page 34.

Printer settings

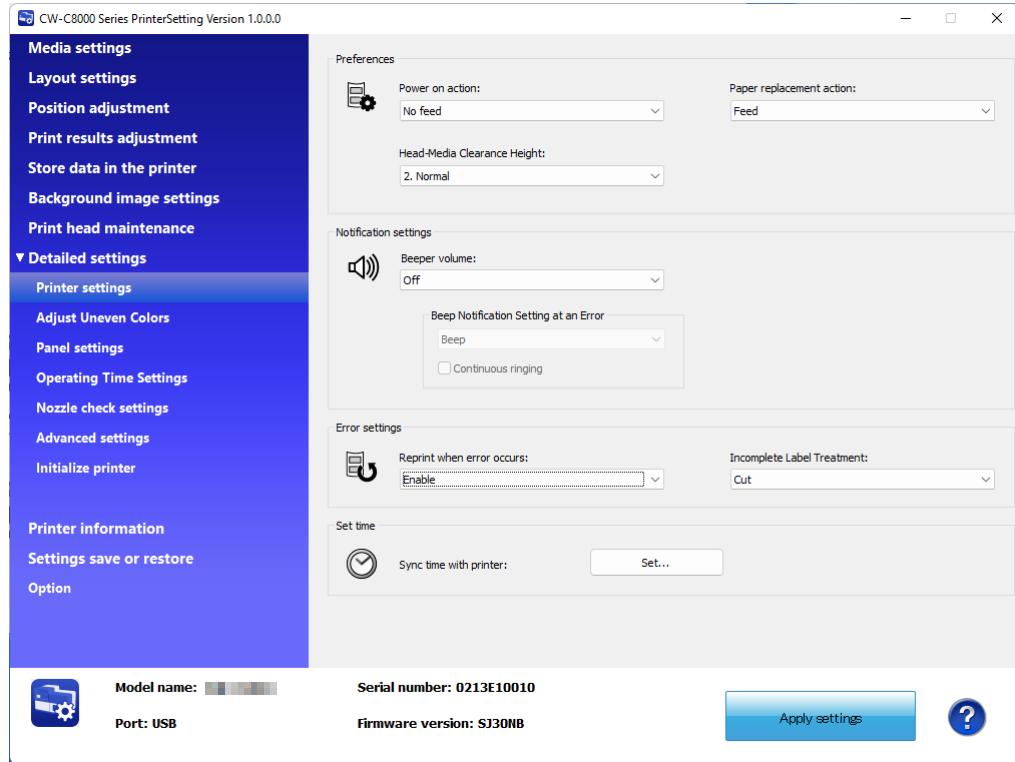
Allows you to configure the printer settings.



Item		Description
Preferences	Power on action	Select a printer action when the printer is powered on.
	Paper replacement action	Select a printer action when paper is replaced.
	Head-Media Clearance Height	Set the gap between the print head and the paper depending on the thickness of the paper to be printed.
Notification settings	Beeper volume	Adjust the volume of the buzzer.
	Beep Notification Setting at An Error	Set whether to sound the buzzer when an error occurs. This setting is available when the [Beeper volume] setting is not [Off].
	Continuous ringing	Select the check box to let the buzzer sound continuously when an error occurs. To stop the beep, press the  (home) button or the  (back) button on the operation panel.
Error settings	Reprint when error occurs	Set whether or not to reprint when an error occurs.
	Incomplete Label Treatment	Set whether or not to cut paper when unfinished labels are generated due to sudden stop of the printer in the middle of printing.
Set time		Set the date and time settings of the printer.

Adjust Uneven Colors

Allows you to adjust the print head to correct uneven colors.

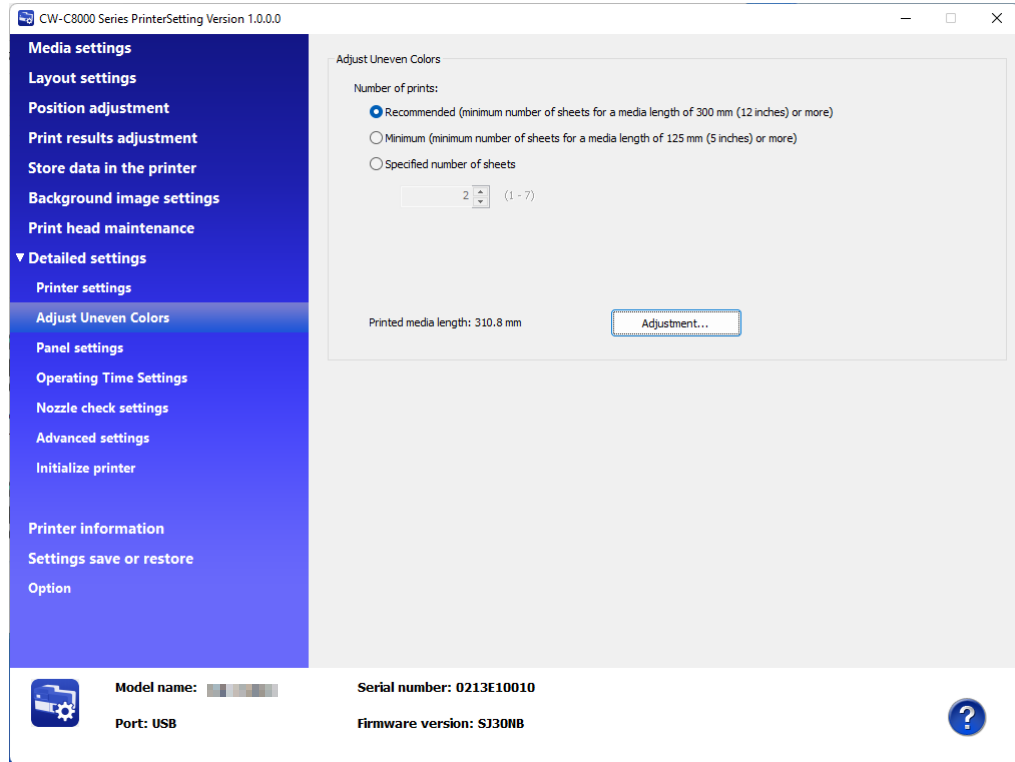

Item	Description
Number of prints	Set the number of sheets used for the uneven color adjustment.
Printed media length	The paper length required to print the adjustment pattern is displayed. The length varies depending on the [Number of prints] setting.

Performing “Adjust Uneven Colors”



IMPORTANT

When printing the uneven color adjustment pattern, load paper that has a print area of at least 50.0 mm {1.97 in.} wide and 25.0 mm {0.98 in.} long. If the paper size does not meet the requirements, an error message will be displayed and the adjustment pattern will not be printed.

- 1 Load the paper to be used for printing the adjustment pattern.
- 2 Set [Number of prints].
Refer to the table below to set the number of sheets to be printed.

Number of prints	Description
Recommended	The minimum number of sheets is set for printing the adjustment pattern on paper 300 mm {12 in.} or longer in length. $300 \text{ mm } \{12 \text{ in.}\} \leq \text{Paper length}^* \times \text{The minimum number of sheets}$
Minimum	The minimum number of sheets is set for printing adjustment pattern on paper between 125 mm {5 in.} and 300 mm {12 in.} in length. $125 \text{ mm } \{5 \text{ in.}\} \leq \text{Paper length}^* \times \text{The minimum number of sheets} < 300 \text{ mm } \{12 \text{ in.}\}$
Specified number of sheets	The number of sheets can be specified in the range that the adjustment pattern is printed on paper between 125 mm {5 in.} and 1016 mm {40 in.}. $125 \text{ mm } \{5 \text{ in.}\} \leq \text{Paper length}^* \times [\text{Specified number of sheets}] < 1016 \text{ mm } \{40 \text{ in.}\}$

* The paper length is the sum of [Length] and [Gap Between Labels].
(["Paper Specifications" on page 370](#))

- 3 Click [Adjustment].
- 4 The uneven color adjustment pattern is printed.
Use the last printed adjustment pattern. Click [OK] on the screen that appears.

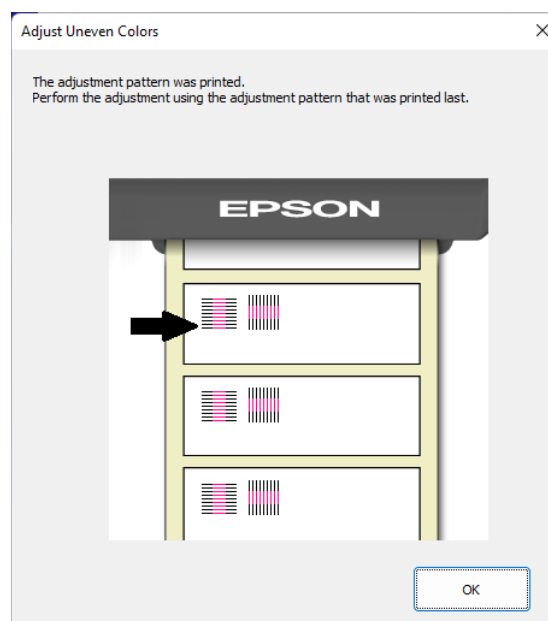

- 5** Enter the number for the most aligned group of horizontal lines and vertical lines in [Vertical direction] and [Horizontal direction], respectively, and click [Apply settings].

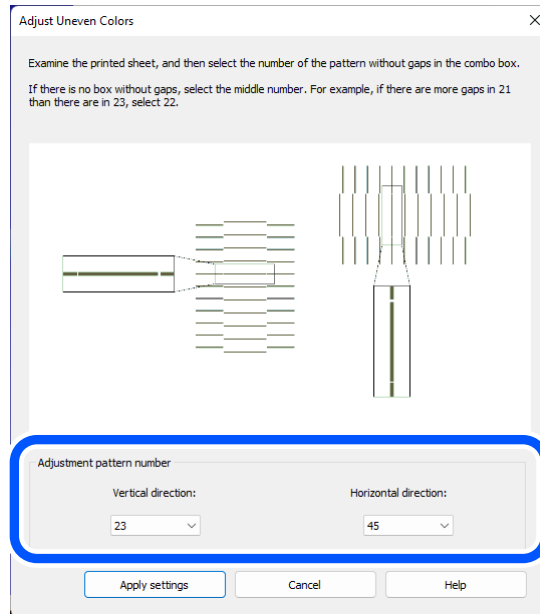

In the example above, the appropriate group numbers are 23 for vertical and 45 for horizontal.

- 6** Click [Yes].

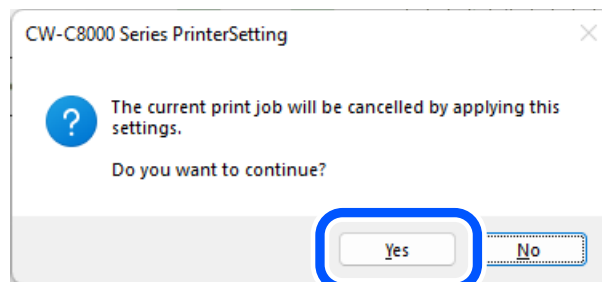





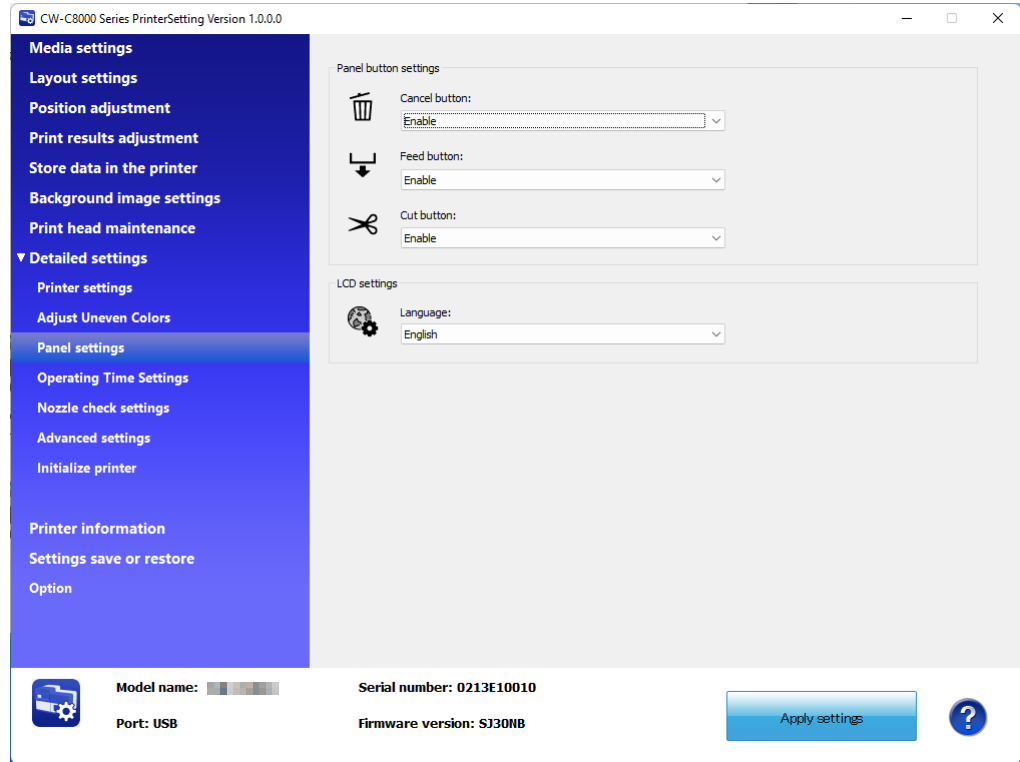

- 7** When adjustment is complete, a complete window appears. Click [OK].

Panel settings

Allows you to configure the panel settings.



Item		Description
Panel button settings	 (cancel) button	Select whether to enable or disable the  cancel button.
	 (feed) button	Select whether to enable or disable the  feed button.
	 (cut) button	Select whether to enable or disable the  cut button.
LCD settings		Select the language to display.

Operating Time Settings

Allows you to change the power saving settings.

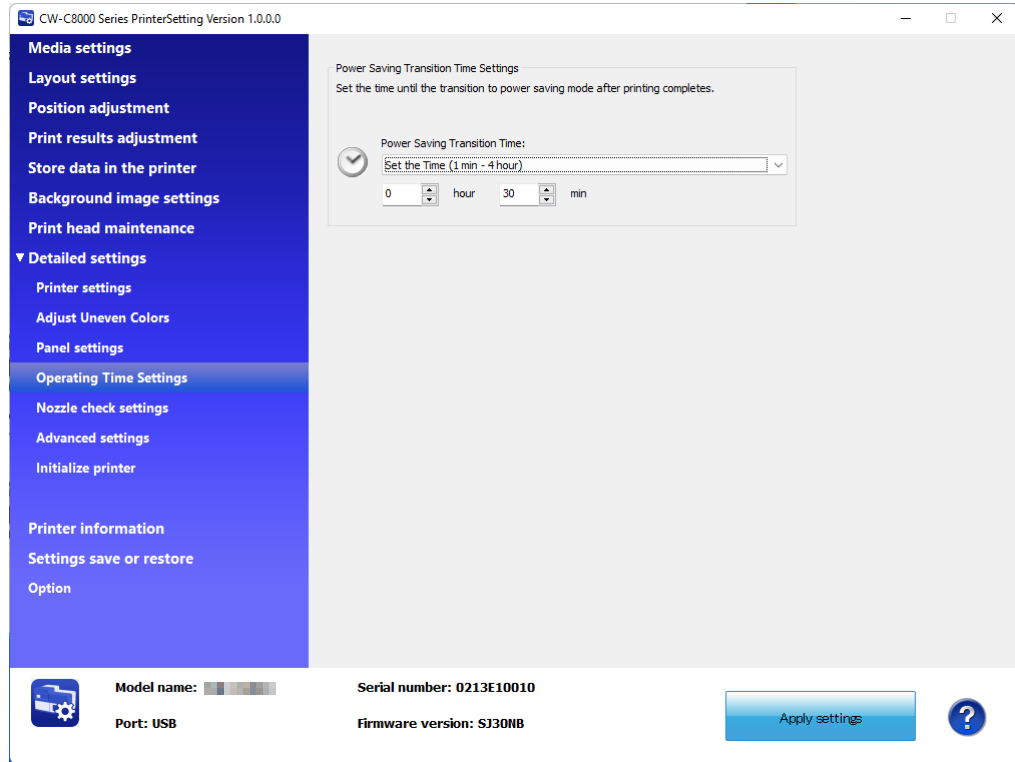

Item	Description
Power Saving Transition Time Settings	Set the time until the printer enters the power saving mode after completing printer operations such as printing and regular automatic cleaning.

Nozzle check settings

Allows you to change the nozzle check settings.

For more details about the nozzle check, see ["Auto Nozzle Check System"](#) on page 30, and for more details about the dot substitution function, see ["Complementary Printing \(Dot substitution\) Function"](#) on page 33.

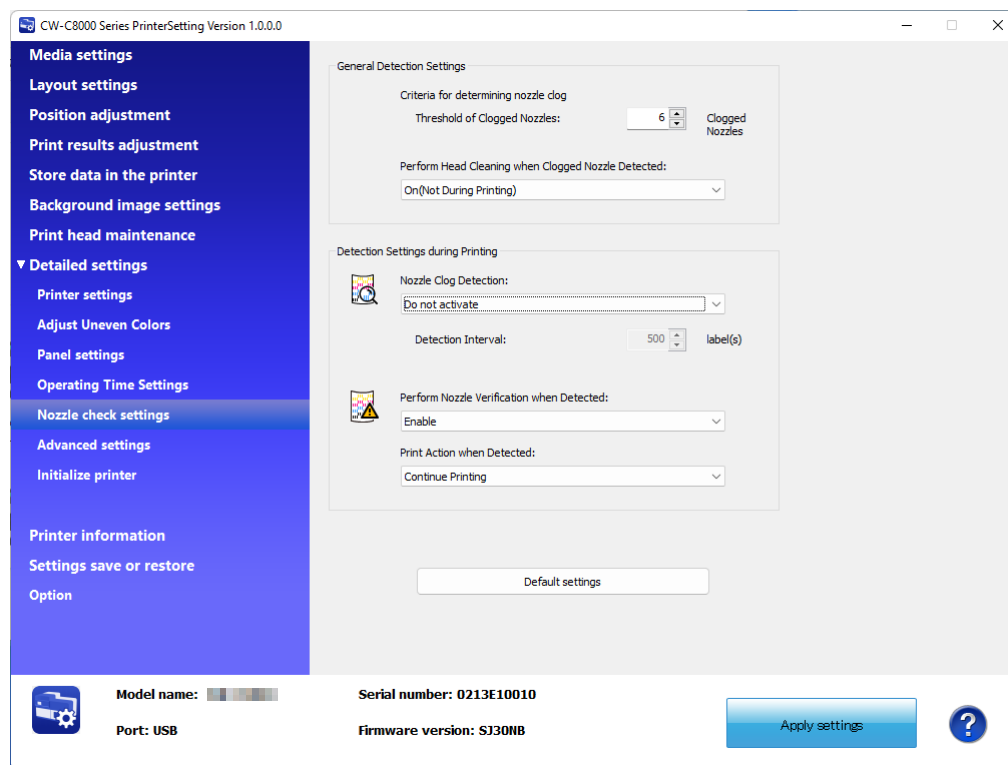

Item		Description
General Detection Settings	Threshold of Clogged Nozzles	Specify the allowable number of clogged nozzles to be used for the self nozzle check system.
	Perform Head Cleaning when Clogged Nozzle Detected	Set whether or not to run print head cleaning automatically when some clogged nozzles are detected.
Detection Settings during Printing	Nozzle Clog Detection	Select whether to run a nozzle check during printing.
	Detection Interval	When [Perform for each specified number of sheets] is selected for [Nozzle Clog Detection], set the number of sheets (how many sheets must be printed before performing a nozzle check).
	Perform Nozzle Verification when Detected	Set whether to use the complementary printing function when nozzle clogging is detected. See "Complementary Printing (Dot substitution) Function" on page 33.
	Print Action when Detected	Set whether to continue or stop printing when the number of clogged nozzles set in [Threshold of Clogged Nozzles] is exceeded.
Default settings		Allows you to restore the nozzle check settings to the state at the time of purchase (default settings).

Advanced settings

Allows you to configure the advanced printer settings.

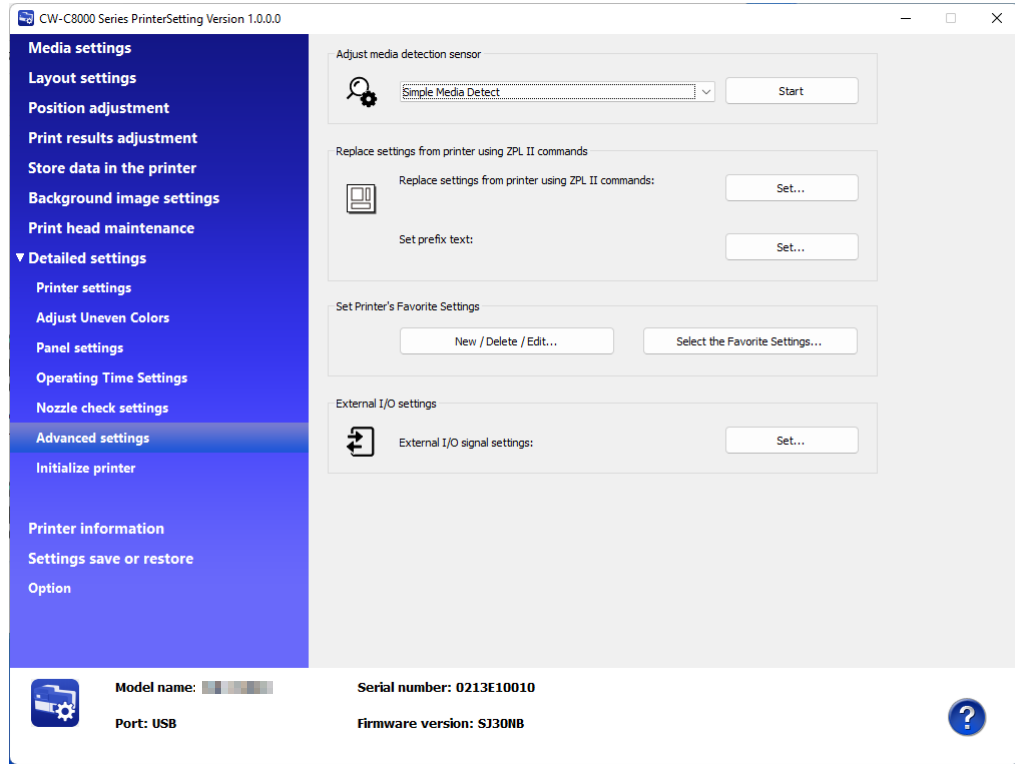

Item		Description
Adjust media detection sensor		Select one of the following menus from the pull-down menu to carry out the sensor calibration. <ul style="list-style-type: none"> • Simple Media Detect Allows you to adjust the threshold for detecting labels. • Media Detect Allows you to adjust the sensitivity of the detectors and the threshold for detecting labels.
Replace settings from printer using ZPL II commands	Replace settings from printer using ZPL II commands	Allows you to make and apply settings for replacing from a ZPL II compatible monochrome printer. The "Replace settings from printer using ZPL II commands" window appears when you click [Set...]. See "Replace Settings from Printer using ZPL II Commands" on page 211.
	Set prefix text	Allows you to set prefix text.
Set Printer's Favorite Settings		Allows you to register favorite settings to the printer, or edit the settings. See "Registering Favorite Settings" on page 215.
External I/O settings		Allows you to set signals for external interface. For more details, refer to "CW-C8000 Series External I/O Technical Reference Guide".

Replace Settings from Printer using ZPL II Commands

Click [Set...] for [Replace settings from printer using ZPL II commands] to open the setting window.



When adjusting, make the adjustment checking actual printouts.

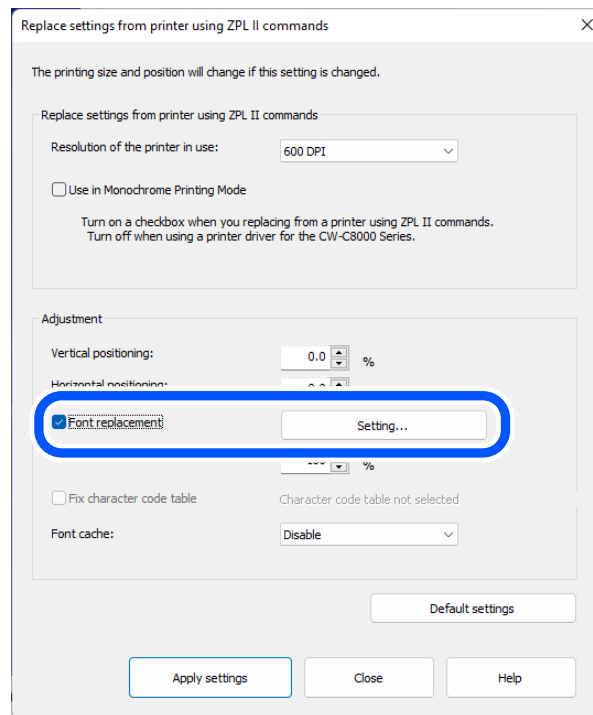

Resolution Settings

From the [Resolution of the printer in use] pull-down menu, select the resolution.

If the same resolution is not found in the menus, select one of the closest resolution. For example, if the resolution of the ZPL II compatible monochrome printer you were using is 203 dpi, select 200 dpi.

Monochrome Print Mode Setting

If you use the printer just as a replacement of your previous ZPL II compatible monochrome printer and do not perform color printing, select the check box.

Vertical/Horizontal Positioning

You can adjust the print position of objects such as text, image, or graphic.

If you have set the same resolution as the resolution of the ZPL II compatible monochrome printer in the [Resolution of the printer in use] setting, set “0” (zero) to both the [Vertical positioning] and [Horizontal positioning].

If the resolution of the ZPL II compatible monochrome printer you were using is 203 dpi, and you have set the [Resolution of the printer in use] setting to [200 dpi], set “-1.5” to both the [Vertical positioning] and [Horizontal positioning].

Font Replacement

Click [Setting] beside [Font replacement].

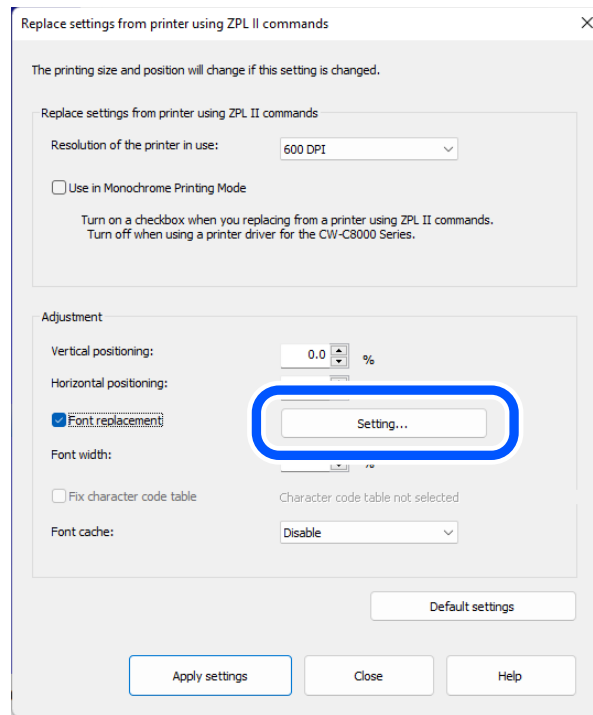

When the setting window is displayed, select the font ID from the list box.

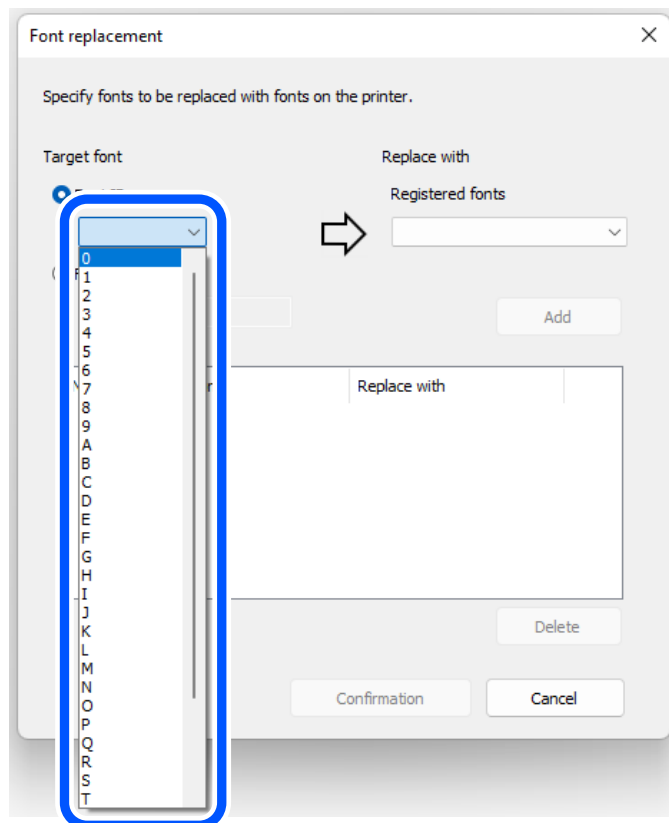

With the font ID specified, select a registered font to be associated to the font ID.

Font replacement

Specify fonts to be replaced with fonts on the printer.

Target font

Font ID

0

Replace with

FONT000.TTF

Add

No.	Target font	Replace with
-----	-------------	--------------

Delete

Confirmation Cancel

Click [Add] to add the pair to the list in the window.

Click [Confirmation] to save the list and go back to the “Replace settings from printer using ZPL II commands” window. Select the check box for [Font replacement] to apply the font replacement settings.

Font replacement

Specify fonts to be replaced with fonts on the printer.

Target font

Font ID

0

Replace with

Registered fonts

FONT000.TTF

Add

No.	Target font	Replace with
1	0	FONT000.TTF

Delete

Confirmation Cancel

Font Width Setting

You can change the font width. At first, set to “100”.



If you want to change the height of font or space between lines, configure it on an application.

Fix Character Code Table

Select the check box for this item to print using character code table set on the CW-C8000 Series printer if an unsupported character code is specified.

Font Cache Settings

The printer accesses the font data on the SD card when replacing fonts.

By enabling the font cache function, the font data on the SD card is cached in the printer's RAM drive, which may reduce printing time.



However, enabling the font cache function consumes space on the printer's RAM drive.

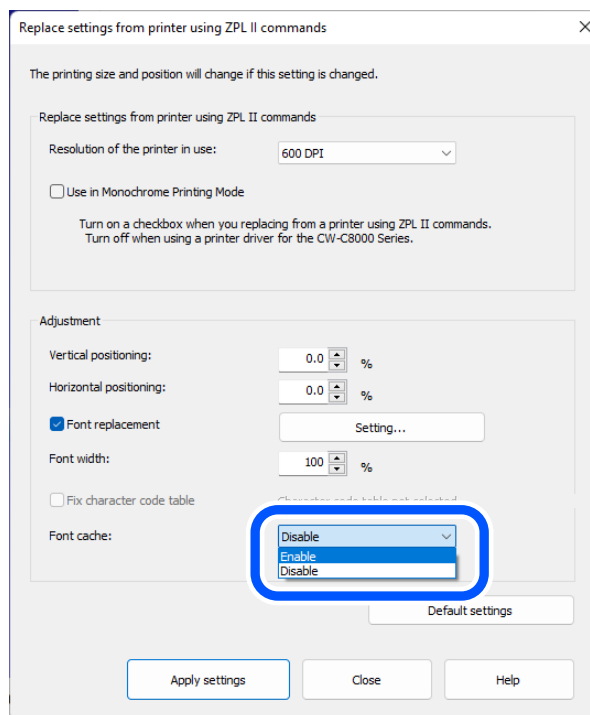

Applying the Settings

When you have finished making necessary settings, click [Apply settings].

All the settings are sent and set to the printer.

Registering Favorite Settings

- 1 Click [New/Delete/Edit] in [Set Printer's Favorite Settings].
- 2 The "Edit Printer's Favorite Settings" window appears. Click [New...].

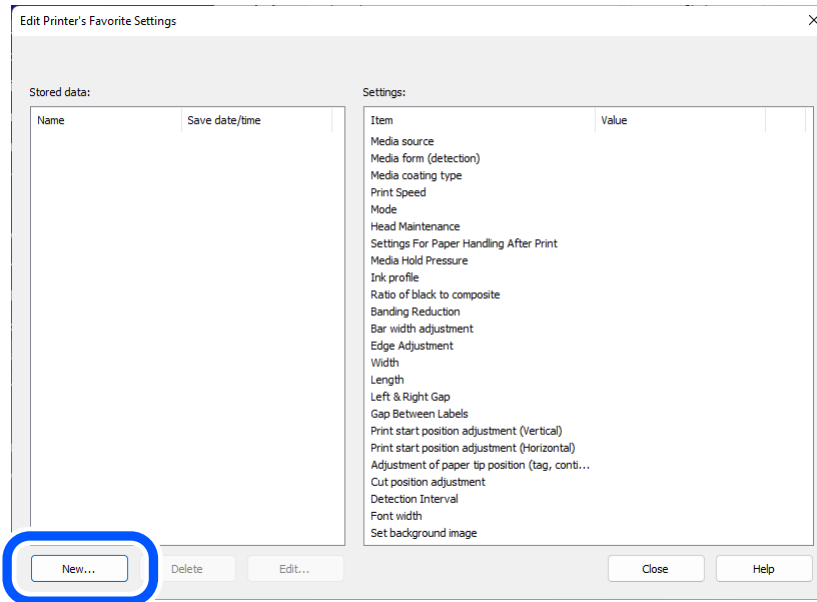

3 The “Register Printer’s Favorite Settings” window appears. Enter a name for the settings in the [Favorite Settings Name] box, and make the settings in [Printer’s Favorite Settings]. When finished, click [Set].



- For the favorite settings name, you can use up to 15 ASCII (20h to 7Eh) characters excluding ^, ~, ;, comma, and period.
- Up to 100 sets of favorite settings can be registered.

When you want to reset your settings to the default settings, click [Default settings].

Register Printer's Favorite Settings

Favorite Settings Name: Units : mm

Printer's Favorite Settings

Media source: Internal(Roll)	Width: 112.0	Print start position adjustment (Vertical): 0.0
Media form (detection): Continuous label (black mark detection)	Length: 152.4	Print start position adjustment (Horizontal): 0.0
Media coating type: Matte Paper	Left & Right Gap: 0.0	Adjustment of paper tip position: 0.0
Mode: EPSON Preferred Color	Gap Between Labels: 3.0	Cut position adjustment: 0.0
Print Speed: 300 mm/s	Ink profile: 0	Detection Interval: 500
Head Maintenance: Pause For Maintenance	Ratio of black to composite: 0	Font width (%): 100
Settings For Paper Handling After Print: Stop at Cut Position	Banding Reduction: 0	Set background image: Use combinations of a template and background image
Media Hold Pressure: Auto	Bar width adjustment: 0	Background image: <input type="text"/>
	<input type="checkbox"/> Edge Adjustment	<input type="button" value="Preview..."/>

Default settings Set Close Help

4 Click [Close] to return to the “Edit Printer’s Favorite Settings” window. The favorite settings you added are displayed in the [Stored data] box.

Applying Favorite Settings

Follow the procedure below to apply the registered favorite settings to the printer.

- 1 Click [Select the Favorite Settings] in [Set Printer's Favorite Settings].
- 2 The "Select Printer's Favorite Settings" window appears. In the [Favorite Settings Name] box, select a set of favorite settings you want to apply to the printer, and then click [Apply settings].

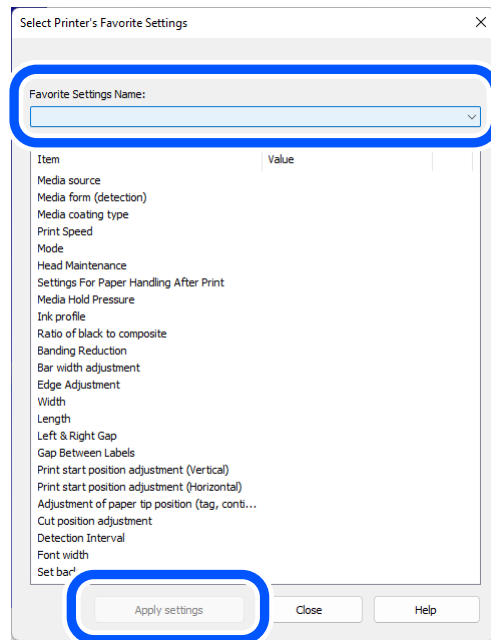

If you frequently change paper and print on different types of paper, it is convenient to register print settings for each type of paper so that you do not have to make print settings from scratch each time you change paper.

Initialize printer

Allows you to initialize the printer.



CAUTION

When the printer is initialized using the [Initialize] menu, all image files and setting files you have registered are deleted.

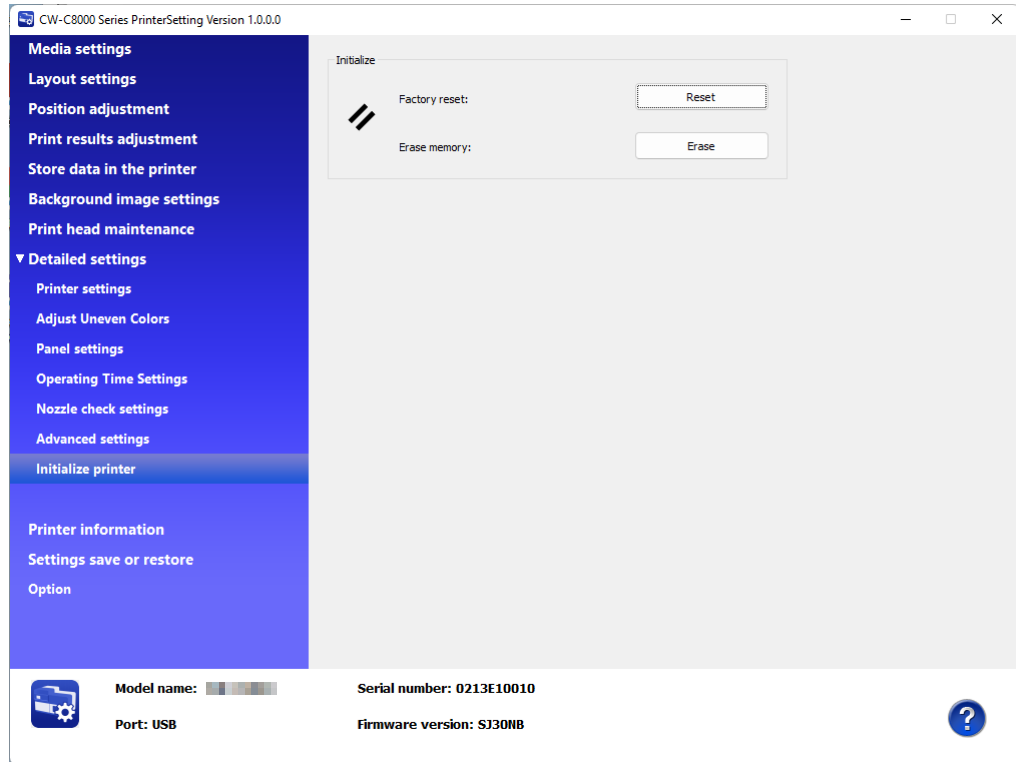

Item		Description
Initialize	Factory reset	Returns the printer settings to their defaults.
	Erase memory	Initializes the extended memory.

Printer information

Displays information of the printer.

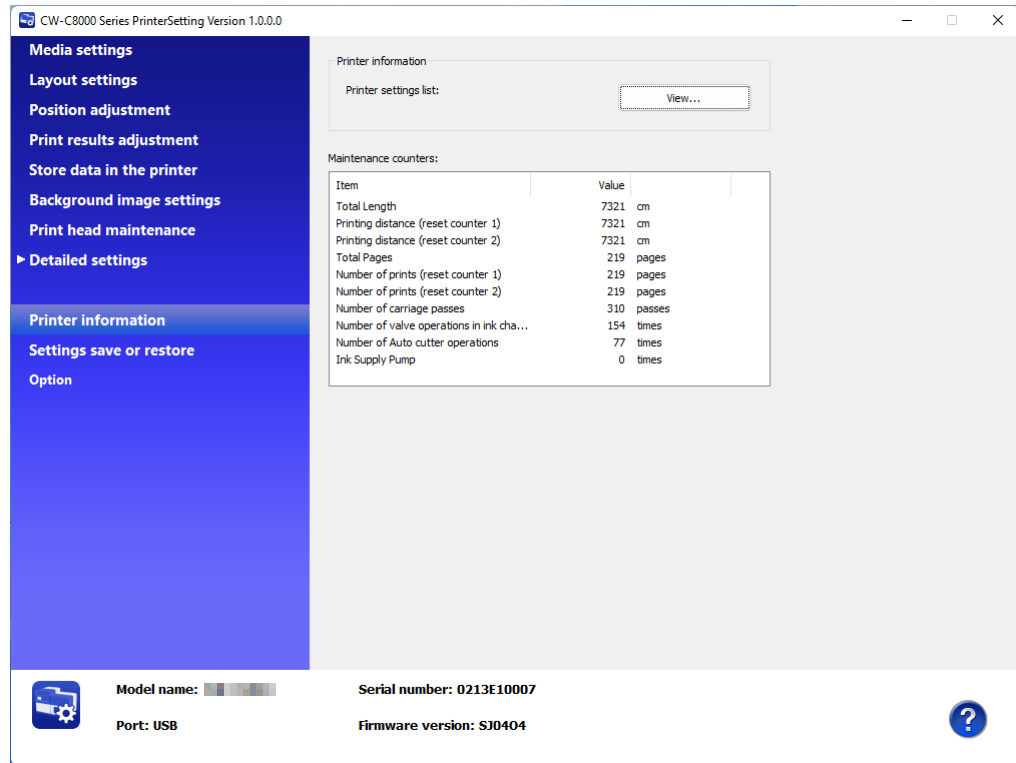

Item		Description
Printer information	Printer settings list	Click [View...] to see the current settings of the printer. See " Printer settings list " on page 220.
Maintenance counters		Allows you to check the maintenance counters.

Printer settings list

The “Printer settings list” window appears when you click [View...]. You can save the settings as a file by clicking [Output to file...].

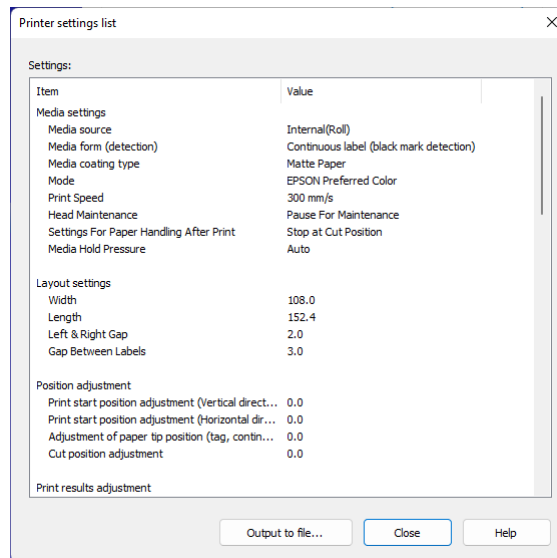

Settings save or restore

Allows you to save the settings of the printer and restore the saved settings.

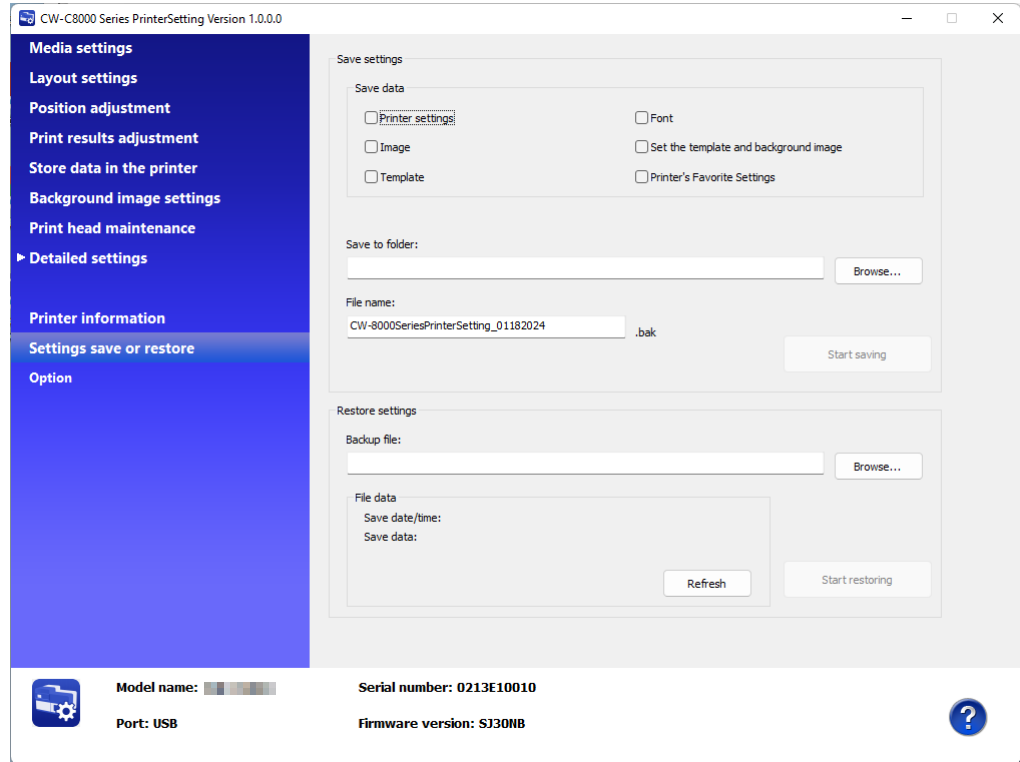

Item		Description
Save settings	Save data	Select setting items to save. Select the check box for the items.
	Save to folder	Specify a folder to save the file.
	File name	Enter a file name.
	Start saving	Click [Start saving] after selecting items to save, specifying a file name and a folder to save. The selected settings will be saved.
Restore settings	Backup file	Select a setting file you have saved.
	File data	Information of the selected file is displayed.
	Start restoring	Click [Start restoring] after selecting a file to restore. The settings of the selected file will be applied.



It may take time depending on the size of the file.

Option

A unit of length used in PrinterSetting and start up setting can be changed.

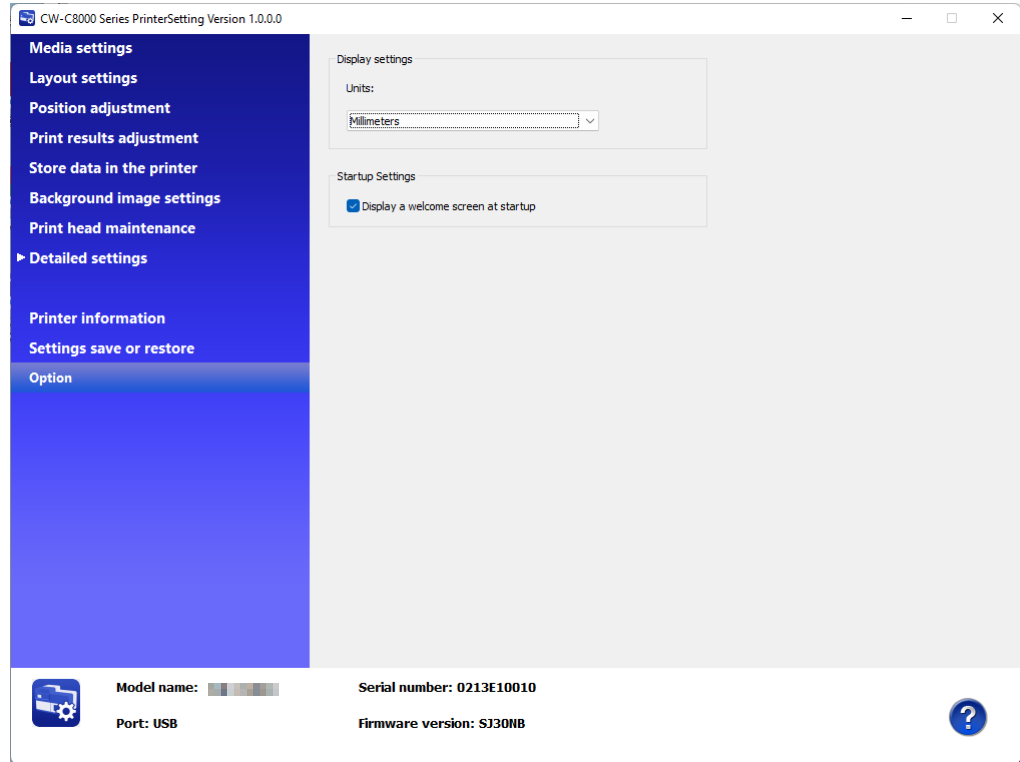

Item		Description
Display settings	Units	Select a unit of length.
Startup Settings	Display a welcome screen at startup	Select this to display a welcome screen at startup



The [Units] setting is for PrinterSetting itself. It cannot be applied to the printer and the printer driver.

Operation Panel Settings

The following tables show the menu items and options available on the operation panel with their default settings and whether they can be locked with Lock Setting of the System Administration settings. For more details about the Lock Setting, see "[Restricting Operation of the Operation Panel \(Lock Setting function\)](#)" on page 237.



- For [Paper Type], administrator lock can be set from both [Paper Settings] and [Print Settings].
- To unlock the administrator lock, unlock the administrator lock for both [Printer Settings] and [Paper Settings].
- If the administrator locks either [Printer Settings] or [Paper Settings], the unlocked [Paper Type] will also be locked.

Setting menu	Settings	Default	Lock Setting		
			General Settings	Printer Settings	Media Settings
Media Settings					
Media Type					
	Plain Paper	Matte Paper	-	✓	✓
	Matte Paper		-	✓	✓
	Synthetic		-	✓	✓
	Texture Paper		-	✓	✓
	Glossy Paper		-	✓	✓
	Glossy Film		-	✓	✓
	High Glossy Paper		-	✓	✓
Media Form					
	Die-cut Label	Die-cut Label	-	-	✓
	Full-page Label		-	-	✓
	Continuous Paper		-	-	✓
	Tag		-	-	✓
Media Detect					
	Gap	Gap	-	-	✓
	Black Mark		-	-	✓
	None		-	-	✓
	Hole		-	-	✓
Media Source					
	Internal	Internal	-	-	✓
	Rear Feed		-	-	✓

Setting menu	Settings	Default	Lock Setting		
			General Settings	Printer Settings	Media Settings
Media Shape					
	Roll	Roll	-	-	✓
	Fanfold		-	-	✓
Media Layout					
Width	21.4-112.0 mm/ 0.84-4.41 in.	108.0 mm/ 4.25 in.	-	-	✓
Length					
Die-cut Label / Full-page Label (Black Mark) / Continuous Paper (Black Mark)	8.0-1016.0 mm/ 0.31-40.00 in.	152.4 mm/ 6.00 in.	-	-	✓
Full-page Label (None) / Continuous Paper (None)	11.0-1016.0 mm/ 0.43-40.00 in.	152.4 mm/ 6.00 in.	-	-	✓
Tag	8.0-300.0 mm/ 0.31-11.81 in.	152.4 mm/ 6.00 in.	-	-	✓
Gap between labels	3.0-6.0 mm/ 0.12-0.24 in.	3 mm/ 0.12 in.	-	-	✓
Left & Right Gap	0-6.0 mm / 0-0.24 in.	2.0 mm / 0.08 in.	-	-	✓
Left Gap	0-30.0 mm/ 0-1.18 in.	2.0 mm / 0.08 in.	-	-	✓
Right Gap	0-30.0 mm/ 0-1.18 in.	2.0 mm / 0.08 in.	-	-	✓
Label Edge to Hole Length	0-306.0 mm/ 0-12.05 in.	28.4 mm / 1.12 in.	-	-	✓
Print Position Adjustment					
Top Position	± 2.0 mm/ ± 0.08 in.	0 mm/ 0 in.	-	-	✓
Left Position	± 1.0 mm / ± 0.04 in.	0 mm/ 0 in.	-	-	✓
Paper Top Position Adjustment Full-page Label (None) / Continuous Paper (None)/ Tag	0-21.7 mm/ 0-0.85 in.	0 mm/ 0 in.	-	-	✓

Setting menu	Settings	Default	Lock Setting			
			General Settings	Printer Settings	Media Settings	
Print Settings						
Media Type						
	Plain Paper	Matte Paper	-	✓	✓	
	Matte Paper		-	✓	✓	
	Synthetic		-	✓	✓	
	Texture Paper		-	✓	✓	
	Glossy Paper		-	✓	✓	
	Glossy Film		-	✓	✓	
	High Glossy Paper		-	✓	✓	
Color Adjustment Mode						
	EPSON Preferred Color	EPSON Preferred Color	-	✓	-	
	EPSON Standard (sRGB)		-	✓	-	
	EPSON Vivid Color		-	✓	-	
	None		-	✓	-	
Print Speed						
	300 mm/s	300 mm/s	-	✓	-	
	150 mm/s		-	✓	-	
Resolution						
	200 dpi	600 dpi	-	✓	-	
	300 dpi		-	✓	-	
	600 dpi		-	✓	-	
Head Maintenance						
	Continuous Printing	Pause For Maintenance	-	✓	-	
	Pause For Maintenance		-	✓	-	
Command Character						
	Control Prefix	0X20 to 7E	0X7E	-	✓	-
	Format Command Prefix	0X20 to 7E	0X5E	-	✓	-
	Delimiter Characters	0X20 to 7E	0X2C	-	✓	-

Setting menu	Settings	Default	Lock Setting		
			General Settings	Printer Settings	Media Settings
Maintenance					
Print Head Nozzle Check	-	-	-	-	-
Print Head Cleaning	-	-	-	-	-
Power Cleaning	-	-	-	-	-
Ink Pack Replacement	-	-	-	-	-
Replace Maintenance Box	-	-	-	-	-
Adjust Uneven Colors	-	-	-	-	-
Calibration					
	Simple Media Detect	-	-	✓	-
	Media Detect		-	✓	-
Nozzle Clog Detection Settings					
General Detection Settings					
Threshold of Clogged Nozzles	0-10	6	-	✓	-
Perform Head Cleaning when Clogged Nozzle Detected	On	On	-	✓	-
	On (Not During Printing)		-	✓	-
	Off		-	✓	-
Detection Settings during Printing					
Nozzle Clog Detection	On	Off	-	✓	-
	Off		-	✓	-
Detection Interval	1-25000	500	-	✓	-
Perform Nozzle Verification when Detected	On	On	-	✓	-
	Off		-	✓	-
Print Action when Detected	Pause Printing	Continue Printing	-	✓	-
	Continue Printing		-	✓	-
Clear All Settings	-	-	-	✓	-
Periodic Cleaning	00:00 to 23:59 (in increments of 1 min.)	00:00	-	✓	-
Ink Discharging	-	-	-	✓	-

Setting menu	Settings	Default	Lock Setting		
			General Settings	Printer Settings	Media Settings
General Settings					
Basic Settings					
LCD Brightness	1 to 5	5	✓	-	-
Sound	Off	Medium	✓	-	-
	Low		✓	-	-
	Medium		✓	-	-
	High		✓	-	-
	Max		✓	-	-
Error Notice	Off	On	✓	-	-
	On		✓	-	-
Repeat Error Notice	Off	Off	✓	-	-
	On		✓	-	-
Length Unit					
	mm	mm	✓	-	-
	inch		✓	-	-
Sleep					
Settings	On	On	✓	-	-
	Off		✓	-	-
Sleep Timer	1 to 240 minutes	30 minutes	✓	-	-
Circuit Breaker Interlock Startup					
	On	Off	✓	-	-
	Off		✓	-	-
Date/Time Settings					
Date/Time	yyyy.mm.dd	-	✓	-	-
	mm.dd.yyyy		✓	-	-
	dd.mm.yyyy		✓	-	-
Daylight Saving Time	Off	-	✓	-	-
	On		✓	-	-
Time Difference	-12:45 to +13:45	-	✓	-	-

Setting menu	Settings	Default	Lock Setting		
			General Settings	Printer Settings	Media Settings
Language	Nederlands	English	-	-	-
	English		-	-	-
	Français		-	-	-
	Deutsch		-	-	-
	Ελληνικά		-	-	-
	Italiano		-	-	-
	日本語		-	-	-
	한국어		-	-	-
	Polski		-	-	-
	Português		-	-	-
	Русский		-	-	-
	简体中文		-	-	-
	Español		-	-	-
	繁體中文		-	-	-
	Türkçe		-	-	-
Background Color	Gray	Black	-	-	-
	Black		-	-	-
	White		-	-	-
			-	-	-
Keyboard	QWERTY	QWERTY	-	-	-
	AZERTY		-	-	-
	QWERTZ		-	-	-

Setting menu	Settings	Default	Lock Setting		
			General Settings	Printer Settings	Media Settings
Control Panel Button Settings					
Cut	Enable	Enable	✓	-	-
	Disable		✓	-	-
Cancel	Enable	Enable	✓	-	-
	Disable		✓	-	-
Feed	Enable	Enable	✓	-	-
	Disable		✓	-	-
Printer Settings					
Image Quality					
Manual Color Adjustments					
Light	-25 to 25	0	-	✓	-
Saturation	-25 to 25	0	-	✓	-
Contrast	-25 to 25	0	-	✓	-
Tone -Cyan	-25 to 25	0	-	✓	-
Tone - Magenta	-25 to 25	0	-	✓	-
Tone -Yellow	-25 to 25	0	-	✓	-
Ink Profile	-3 to 10 (in increments of 1)	0	-	✓	-
Ratio of Black to Composite	-6 to 0 (in increments of 1)	0	-	✓	-
Banding Reduction	-3 to 7 (in increments of 1)	0	-	✓	-
Bar Width Adjustment	- 2 to 2 (in increments of 1)	0	-	✓	-
Edge Adjustment	On	Off	-	✓	-
	Off		-	✓	-

Setting menu	Settings	Default	Lock Setting		
			General Settings	Printer Settings	Media Settings
Print Options					
Print Mode					
Cut	-	Stop at Cut Position	-	✓	-
Stop at Cut Position	-		-	✓	-
Stop at Specified Position	-		-	✓	-
Specified Stop Position	0-50.0 mm / 0-1.97 in.	0 mm/ 0 in.	-	✓	-
Cut Position	-20.0 to 1.5 mm/ -0.785 to 0.06 in.	0 mm/ 0 in.	-	✓	-
Reprint					
	Enable	Enable	-	✓	-
	Disable		-	✓	-
Incomplete Label Treatment	Cut	Cut	-	✓	-
	Never Cut		-	✓	-
Media Hold Pressure					
Setting	Auto	Auto	-	✓	-
	Manual		-	✓	-
Media Hold Pressure	1 to 10	10	-	✓	-
Head-Media Clearance Height	1 to 4	2	-	✓	-
Cancel Action					
	Job ONLY	Job ONLY	-	✓	-
	Job/RAM Drive		-	✓	-
External I/O Settings					
End print signal	Disable Signal	Disable Signal	-	✓	-
	Low level Enable		-	✓	-
	High level Enable		-	✓	-
	Low Pulse Enable		-	✓	-
	High Pulse Enable		-	✓	-

Setting menu				Settings	Default	Lock Setting			
						General Settings	Printer Settings	Media Settings	
				Data ready signal	Disable Signal	Disable Signal	-	✓	-
				Low level Enable	-		✓	-	
				High level Enable	-		✓	-	
				Missing dot detected signal	Disable Signal	Disable Signal	-	✓	-
					Low level Enable		-	✓	-
					High level Enable		-	✓	-
				Head maintenance signal	Disable Signal	Disable Signal	-	✓	-
					Low level Enable		-	✓	-
					High level Enable		-	✓	-
				Printer ready signal	Disable Signal	Disable Signal	-	✓	-
					Low level Enable		-	✓	-
					High level Enable		-	✓	-
				Warning signal	Disable Signal	Disable Signal	-	✓	-
					Low level Enable		-	✓	-
					High level Enable		-	✓	-
				Error & Pause Signal	Disable Signal	Disable Signal	-	✓	-
					Normally High, Low on Error		-	✓	-
					Normally Low, High on Error		-	✓	-
					Normally High, Low on Error/Pause		-	✓	-
					Normally Low, High on Error/Pause		-	✓	-
				Ink low signal	Disable Signal	Disable Signal	-	✓	-
					Low level Enable		-	✓	-
					High level Enable		-	✓	-
				Ink end signal	Disable Signal	Disable Signal	-	✓	-
Low level Enable	-	✓	-						
High level Enable	-	✓	-						

Setting menu	Settings	Default	Lock Setting				
			General Settings	Printer Settings	Media Settings		
	Paper end signal	Disable Signal	Disable Signal	-	✓	-	
		Low level Enable		-	✓	-	
		High level Enable		-	✓	-	
	Pause signal	Ignore signal	Ignore signal	-	✓	-	
		Execute at Low		-	✓	-	
	Head cleaning signal	Ignore signal	Ignore signal	-	✓	-	
		Execute at Low		-	✓	-	
	Missing dot check signal	Ignore signal	Ignore signal	-	✓	-	
		Execute at Low		-	✓	-	
	Feed signal	Ignore signal	Ignore signal	-	✓	-	
		Execute at Low		-	✓	-	
	Start print signal	Ignore signal	Ignore signal	-	✓	-	
		Execute at Low		-	✓	-	
		Execute during Low		-	✓	-	
	Re-print signal	Ignore signal	Ignore signal	-	✓	-	
		Execute at Low		-	✓	-	
	Actions when Replacing Media						
		Feed	Feed	-	✓	-	
		Not Feed		-	✓	-	
		Calibration		-	✓	-	
		Short Calibration		-	✓	-	
		Check Media Size		-	✓	-	
	Actions on Power On						
		Feed	Not Feed	-	✓	-	
	Not Feed	-		✓	-		
	Calibration	-		✓	-		
	Short Calibration	-		✓	-		
	Check Media Size	-		✓	-		

Setting menu	Settings	Default	Lock Setting		
			General Settings	Printer Settings	Media Settings
Network Settings					
Wi-Fi Setup					
Router					
Wi-Fi Setup Wizard	-	-	✓	-	-
Push Button Setup (WPS)	-	-	✓	-	-
Others	PIN Code Setup (WPS)	-	✓	-	-
	Wi-Fi Auto Connect	-	✓	-	-
	Disable Wi-Fi	-	✓	-	-
Wi-Fi Direct					
iOS	-	-	✓	-	-
Other OS Devices	-	-	✓	-	-
Change Settings					
Change Network Name		-	✓	-	-
Change Password		-	✓	-	-
Change Frequency Range	2.4 GHz	2.4 GHz	✓	-	-
	5 GHz		✓	-	-
Disable Wi-Fi Direct		-	✓	-	-
Restore Default Settings		-	✓	-	-
Wired LAN Setup					
Network Status					
Wired LAN/Wi-Fi Status		-	✓	-	-
Wired LAN Status		-	✓	-	-
Wi-Fi Direct Status		-	✓	-	-
Print Status Sheet		-	✓	-	-
Connection Check					

Setting menu	Settings	Default	Lock Setting		
			General Settings	Printer Settings	Media Settings
Advanced					
Device Name	-	-	✓	-	-
TCP/IP	-	-	✓	-	-
Proxy Server	-	-	✓	-	-
IPv6 Address					
	Enable	Enable	✓	-	-
	Disable		✓	-	-
Link Speed & Duplex					
	Auto	Auto	✓	-	-
	100BASE-TX Auto		✓	-	-
	10BASE-T Half Duplex		✓	-	-
	10BASE-T Full Duplex		✓	-	-
	100BASE-TX Half Duplex		✓	-	-
	100BASE-TX Full Duplex		✓	-	-
Redirect HTTP to HTTPS					
	Enable	Enable	✓	-	-
	Disable		✓	-	-
Disable IPsec/IP Filtering	-	-	✓	-	-
Disable IEEE802.1X	-	-	✓	-	-
System Administration					
Clear Internal Memory Data	-	-	✓	-	-
Security Settings					
Admin Settings					
Admin Password					
	Change	-	✓	-	-
	Restore Default Settings	-	✓	-	-
Lock Setting					
	On	Off	✓	-	-
	Off		✓	-	-

Setting menu	Settings	Default	Lock Setting		
			General Settings	Printer Settings	Media Settings
General Settings					
	On	-	✓	-	-
	Off	*Fixed to "On" when Lock Setting is set to On.	✓	-	-
Printer Settings					
	On	Off	✓	-	-
	Off		✓	-	-
Paper Setting					
	On	Off	✓	-	-
	Off		✓	-	-
Password Encryption		Off	✓	-	-
		On	✓	-	-
Restore Default Settings					
Network Settings		-	✓	-	-
Media Detect		-	✓	-	-
All Settings		-	✓	-	-
Language		-	-	-	-
Favorite Setting		-	-	-	-
Supply Status		-	-	-	-
Printer Status/Print					
Firmware Version		-	-	-	-
Print Status Sheet					
Configuration Status Sheet		-	-	-	-
Font List		-	-	-	-
Barcode List		-	-	-	-
Image List		-	-	-	-
Template List		-	-	-	-
Network		-	-	-	-

Setting menu	Settings	Default	Lock Setting		
			General Settings	Printer Settings	Media Settings
Maintenance Counters					
Total Length	-	-	-	-	-
Length 1	-	-	-	-	-
Length 2	-	-	-	-	-
Total Pages	-	-	-	-	-
Pages 1	-	-	-	-	-
Pages 2	-	-	-	-	-
Total CR	-	-	-	-	-
Total Auto Cut	-	-	-	-	-
Valve	-	-	-	-	-
Ink Supply Pump	-	-	-	-	-

Restricting Operation of the Operation Panel (Lock Setting function)

The [Lock Setting] function allows an administrator to lock the paper settings, printer settings, and/or system administration related settings to prevent unauthorized changes.

The procedure is as follows.

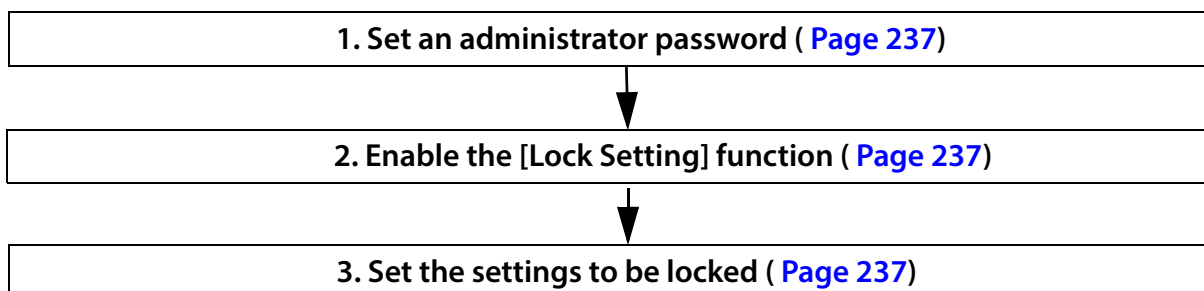

The following settings can be locked.

General Settings: Settings that are rarely changed once you configure them, such as the network settings and date/time settings.

Media Settings: Settings related to media (paper)

Printer Settings: Menus for adjusting or maintaining the printer and the print settings

See the "Lock Setting" columns in "[Operation Panel Settings](#)" on page 223 for details on items that can be locked.

Checking the Initial Value for the Administrator Password

The default administrator password is written next to "PASSWORD" on the password label on the right side of the printer.



In the example shown, the initial password is 03212791.

Enabling the [Lock Setting] Function

Set an administrator password in advance.

- 1** Select [Menu] - [General Settings] - [System Administration] - [Security Settings] - [Admin Settings] in that order.
- 2** Set [Lock Setting] to [On].
Options that allow you to set which settings to lock are displayed.

- 3** Select the target options you want to lock, set it to [On], and then press the OK button.



When you set [Lock Setting] to [On], the [General Settings] option is automatically set to [On]. You cannot set the [General Settings] option to [Off] with [Lock Setting] set to [On].

- 4** When a confirmation message is displayed, select [Yes].

Once the Lock Setting is enabled, the administrator password is required when changing any one of the locked settings.

Changing the Administrator Password

- 1** Select [Menu] - [General Settings] - [System Administration] in that order.
- 2** Enter the current administrator password, and then select [OK] on the screen.
- 3** Select [Security Settings] - [Admin Settings] - [Admin Password] - [Change] in that order.
- 4** Enter the current administrator password, and then select [OK] on the screen.
- 5** Enter a new administrator password, and then select [OK] on the screen.





Set the new password using alphanumeric characters and symbols, with a length of eight or more characters but no more than 20 characters.

- 6** Enter the new password again, and then select [OK] on the screen.
- 7** When a message is displayed, press the OK button.

Resetting the Administrator Password

If you forgot the password, reset the password following the procedure below.

- 1** Press the  (Home) button to display the home screen.
- 2** Hold down the  (back) button and  (cancel) button at the same time.
- 3** When a confirmation message is displayed, select [Yes].
- 4** Enter the value for "PASSWORD" on the password label affixed to the right side of the printer, and then select [OK] on the screen.

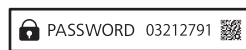

For this example, enter 03212791.

- 5** When a message is displayed, press the OK button.

Web Config

Web Config is an application software that allows you to check or change the printer settings using a web browser on a computer.

To use Web Config, you need to set up an IP address to the printer in advance.

Connect the computer to the same network as the printer.

 ["Configuring Network Settings" on page 51](#)

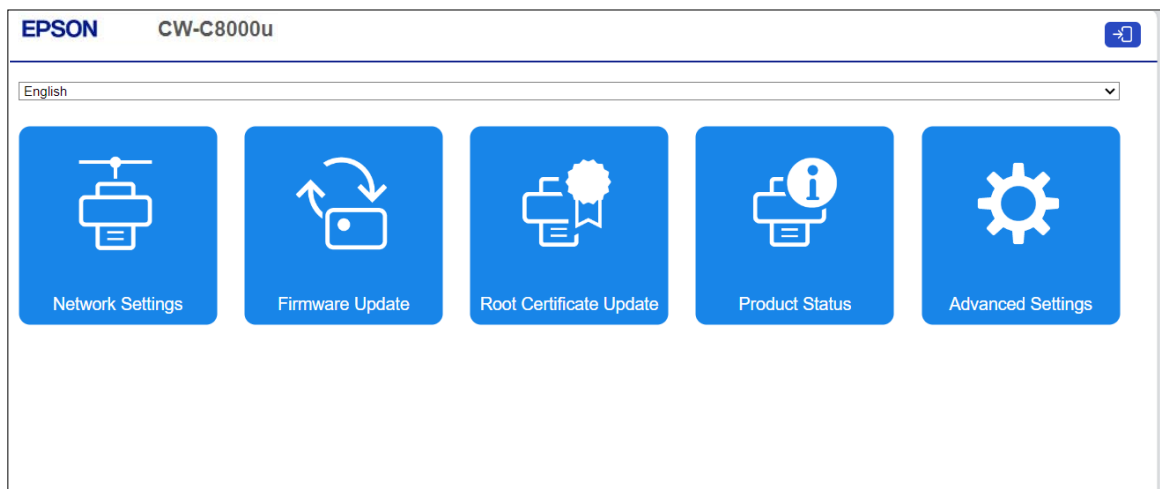

It is not possible to set the administrator logon to be unnecessary. If you forget the administrator password, you can initialize it. ("[Resetting the Administrator Password" on page 239](#)")

How to Start Web Config

Start a web browser on a computer or device that is connected via a network, and then type the printer IP address into the browser. To change the printer settings, log in from [Administrator Login] on the upper right corner of the screen.

Leave the User Name field blank. Enter the default administrator password, which is the value for “PASSWORD” on the password label affixed to the right side of the printer.



In the example shown, the initial password is 03212791.

Enable the JavaScript on the browser. Because the communication with the printer uses a self-signed certificate of the printer over HTTPS, a warning message is displayed on the browser when you start Web Config.

Communication over HTTPS

IPv4: `https://IP address of the printer`

IPv6: `https://[IP address of the printer]`

Communication over HTTP

IPv4: `http://IP address of the printer`

IPv6: `http://[IP address of the printer]`

Examples

IPv4:

`https://192.0.2.111/`

`http://192.0.2.111/`

IPv6:

`https://[2001:db8::1000:1]/`

`http://[2001:db8::1000:1]/`

Epson Device Admin

Epson Device Admin is multifunctional software that allows you to manage printers on a network.

It offers the following functions.

- Monitoring and managing networked printers
- Issuing a detailed report on consumables and printer status
- Updating printer's firmware
- Installing a new networked printer
- Configuring various settings of a networked printer
- Configuring various settings of multiple networked printers at a time

You can download Epson Device Admin from the Epson website.

**CAUTION**

For the CW-C8000 Series printers, Epson Device Admin supports Ethernet connection only. It cannot be used if the printer is connected via USB.

EPSON Cloud Solution PORT

EPSON Cloud Solution PORT supports customers in maximizing production by visualizing on-site conditions, such as printer operation information and error status, via PC and mobile devices.

Solutions for remote printing/distributed printing

Visualize printer status (production monitor)

It is possible to monitor the remaining ink and operating status of printers, calculate running costs of consumables, and analyze printer standby time and print load bias.

Remote service

By connecting your printer to Epson, Epson can monitor and respond to operational status and error conditions in a timely manner.



However, this product does not support color management and workflow solutions.

How to Register the Printer



IMPORTANT

- The IP address of the printer must be set in advance. USB connection is not supported.
- Please subscribe to Epson Cloud Solution PORT before registering your printer.

- 1 Log in to Epson Cloud Solution PORT if you are not already logged in.
<https://port.epson.com/>

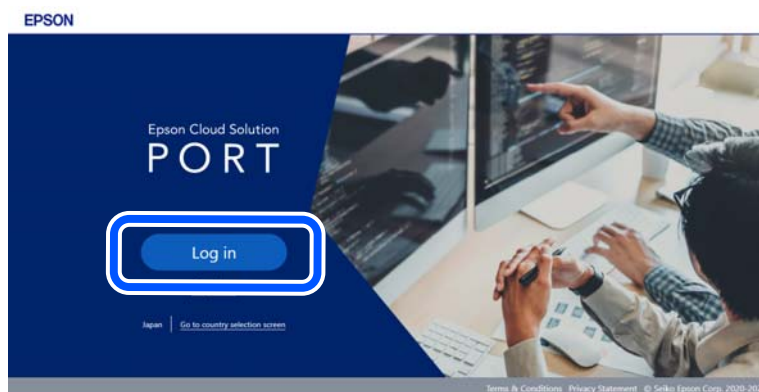

If the Epson Global ID login screen appears, enter your email address and password.

2 From the Home screen, select [My Devices].



3 Click [+Add].

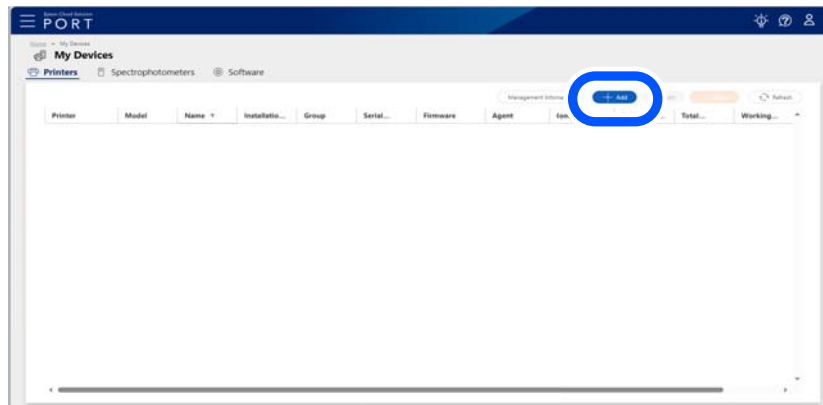

4 Select [Download Software].

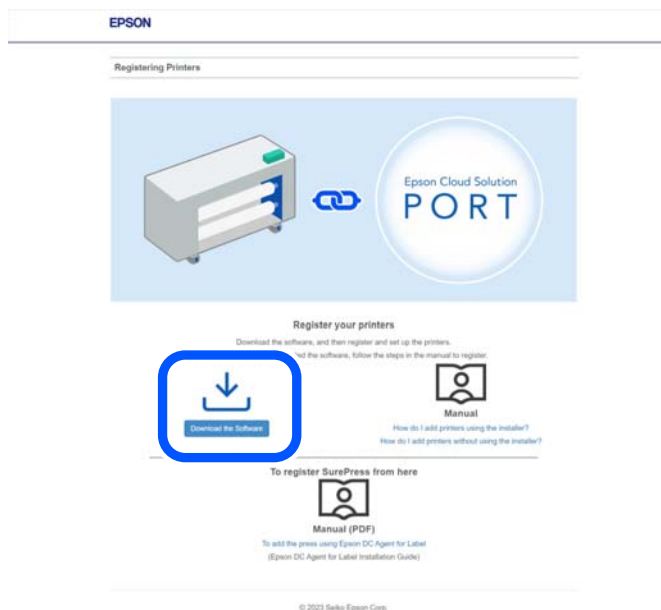

- 5 Download it by specifying any storage location in your browser.
- 6 Ensure that the software has been downloaded.
- 7 Double-click the downloaded installer.
The installer will start.
- 8 The installer will display the following screen. Accept the license agreement and click [Yes]. Follow the on-screen instructions to register the printer.

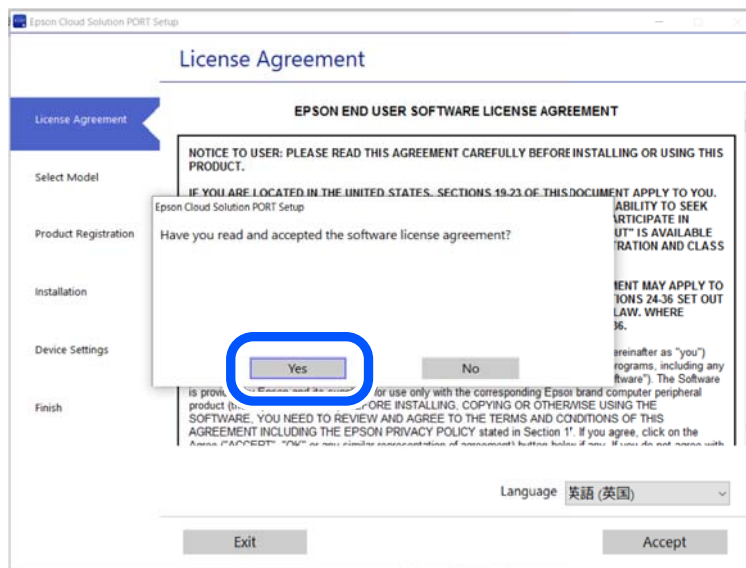

Once the printer is registered in Epson Cloud Solution PORT, the printer will appear in the printer list. The list of printers can be viewed by selecting [My Devices] on the home screen.

<https://port.epson.com/>

Printer	Model	Name	Installable	Group	Serial	Firmware	Agent	Computer	Self-repair	Total	Working	Cumulative
	EC-1400...		---	---	781628803	V2.2004	ES Agent for...	---	---	8279	408	386,00 m ³ 4154,87 m ³
	EC-1400...	2021100000	---	---	801100000	V2.2004	DC Agent for...	2021100000	---	34721	---	383,00 m ³ 4243,87 m ³
	EC-1400...	2008100000	---	---	800810000	V2.1904	DC Agent for...	---	---	84455	---	---
	EC-1400...	1903200014	---	---	800300014	V2.2004	ES Agent for...	---	---	17683	432	88,00 m ³ 711,95 m ³
	EC-1400...		---	---	872000000	V2.2004	ES Agent for...	---	---	381883	382	4476,00 m ³ 4879,27 m ³
	EC-1400...		---	---	872000000	V2.2004	DC Agent for...	---	---	4398700	---	4398700 m ³

Using Loftware's Loftware Cloud

Loftware Cloud is a cloud-based label management system from Loftware. The entire process of creating labels, including design, management, data linkage, and printing, can be managed in the cloud. In order to print from Loftware Cloud, the printer must be registered with Loftware Cloud and configured in Web Config or Epson Device Admin.

["Registering a Printer \(Web Config\)" on page 246](#)

["Registering a Printer \(Epson Device Admin\)" on page 253](#)



For more information about how to use Loftware Cloud, select  in the upper right corner to view the Help section.

Registering a Printer (Web Config)

- 1 **Open Web Config, and log in from the [Log in].**
Web Config

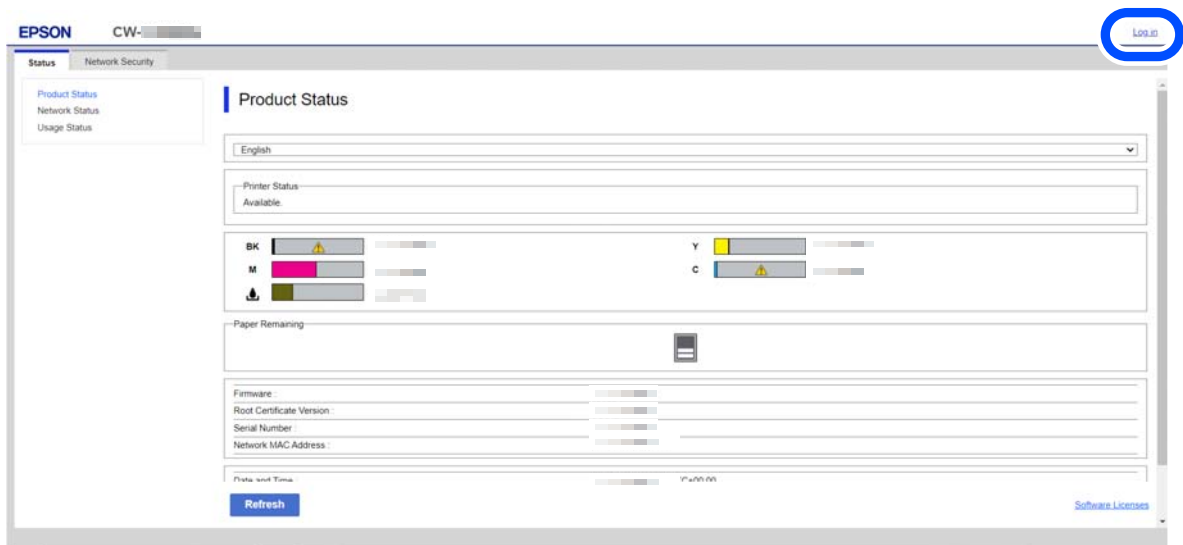

For details on Web Config, see ["Web Config" on page 240](#).

2 Check the following settings in the [Network] tab.

- IP Address
- Subnet Mask
- Default Gateway
- Primary DNS Server
- Secondary DNS Server
- Proxy Server
- Proxy Server Port Number

Web Config

EPSON CW-C4520 Administrator Logout

Status Print **Network** Network Security Product Security Device Management Maintenance

Basic
Wired LAN
Software Cloud
» Basic

Basic

Device Name : EPSONA5C1BA
Location :

Note: The values in Device Name and Location are applied to multiple network protocols.

Obtain IP Address : Auto Manual
Set using BOOTP : Enable Disable
Set using Automatic Private IP Addressing : Enable Disable

IP Address : 192.168.1.4
Subnet Mask : 255.255.252.0
Default Gateway : 192.168.1

Primary DNS Server : 192.168.8
Secondary DNS Server : 192.168.8

DNS Host Name : EPSONA5C1BA
DNS Domain Name Setting : Auto Manual
DNS Domain Name :
Register the network interface address to DNS : Enable Disable

Proxy Server : 192.168.255
Proxy Server Port Number : 8080

Proxy Server Username :
Proxy Server Password : *****

IPv6 Setting : Enable Disable
IPv6 Privacy Extension : Enable Disable
IPv6 DHCP Server Setting : Do Not Use Use
IPv6 Address :
IPv6 Address Default Gateway :
IPv6 Link-Local Address : fe80::dec:d:2ff:fea5:c1ba/64
IPv6 Stateful Address :
IPv6 Stateless Address 1 :

Next

3 Open Software Control Center and sign in.

Please get the account information to sign in from Software company.

4 Select [Printers] in the tree on the left, and then select [Cloud Printers] - [Add]. Loftware Cloud

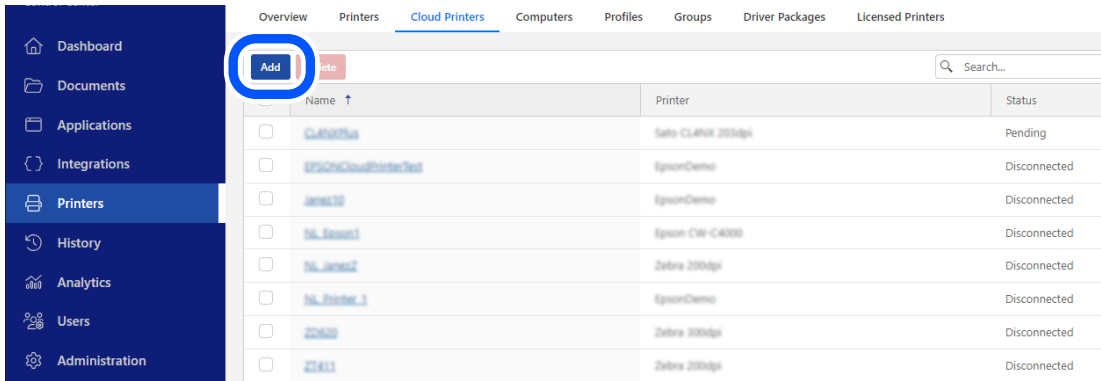

5 Set [Name] and [Printer] for the new cloud printer. Loftware Cloud

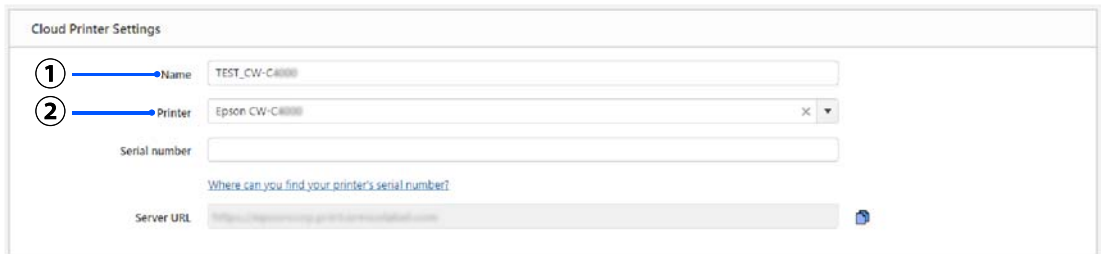

- (1) [Name] Enter the name you want to display on Loftware Cloud.
- (2) [Printer] Select the printer to set as a cloud printer.

Printer to be selected	Printer you are using
Epson CW-C8000	CW-C8000u, CW-C8000e, CW-C8010, CW-C8020, CW-C8030, CW-C8040, CW-C8050



When you select [Printer], [Serial number] and [Server URL] will appear.

6 Open [Status] - [Product Status] in Web Config, copy the serial number of the printer, and paste it into [Serial number] in Loftware Cloud.

Web Config

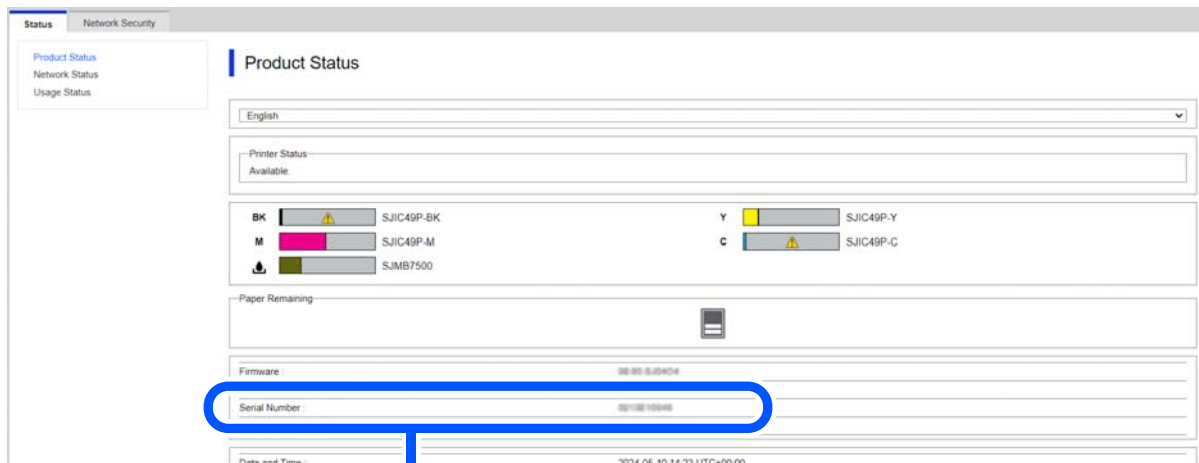

Loftware Cloud

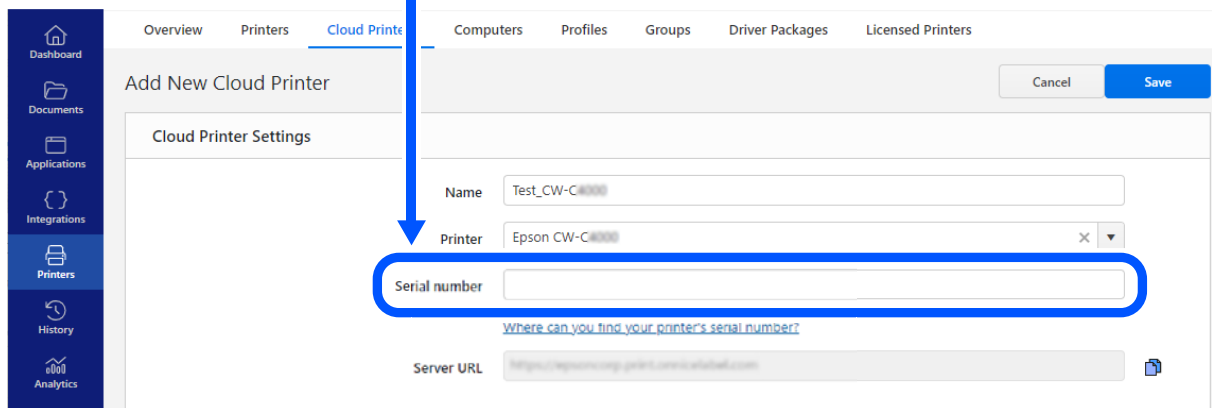

7 Select [Save].

Loftware Cloud

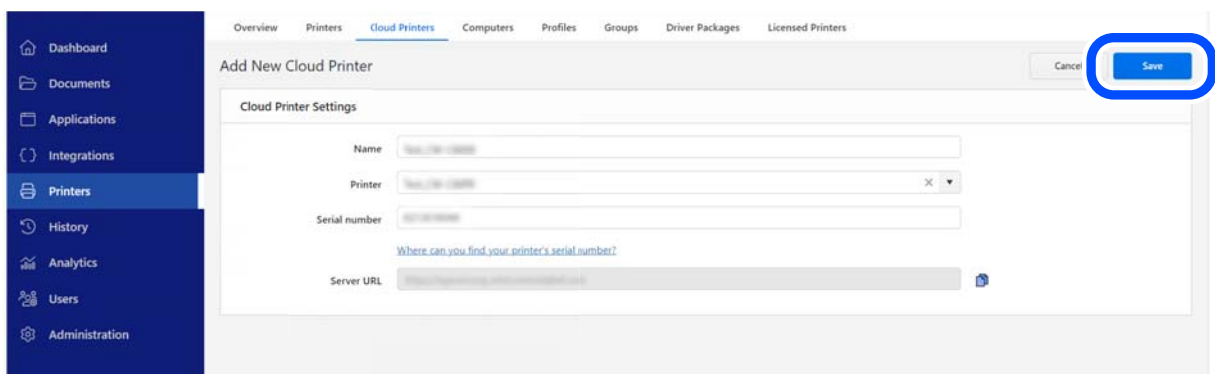

8 Select the saved printer from [Cloud Printers]. Loftware Cloud

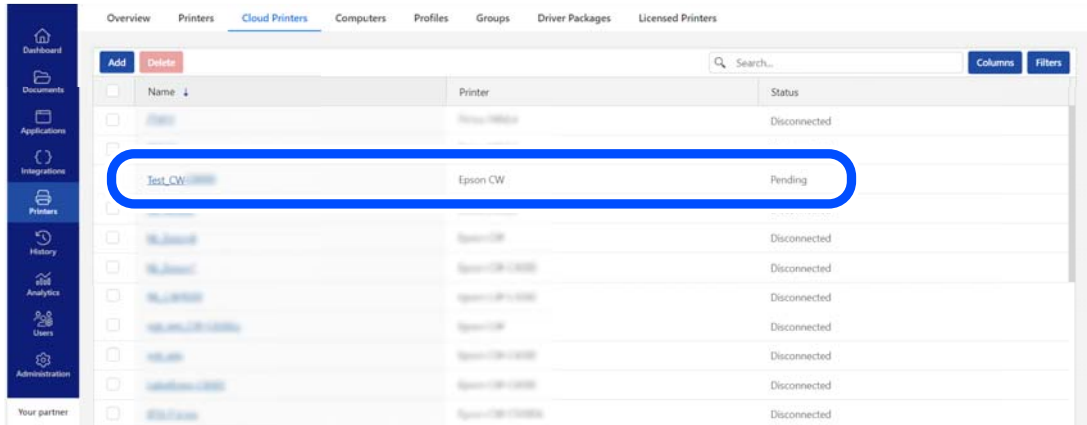

9 Click the button to copy the server URL and paste it into the following field in Web Config.

[Network] - [Loftware Cloud] - [Basic] - [URL]

Loftware Cloud

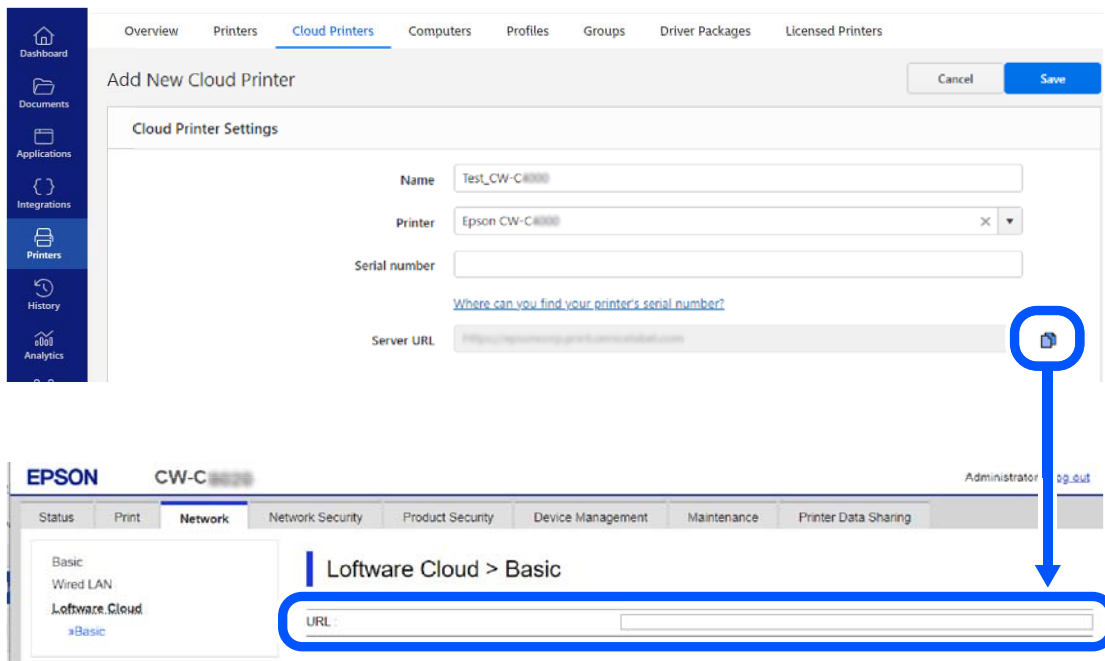

10 Click [OK]. Web Config

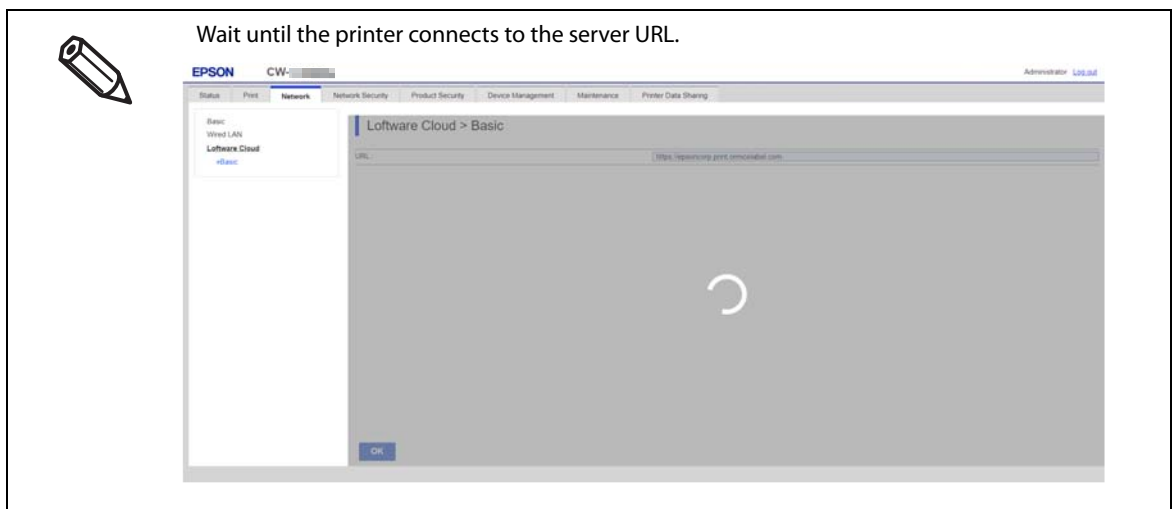
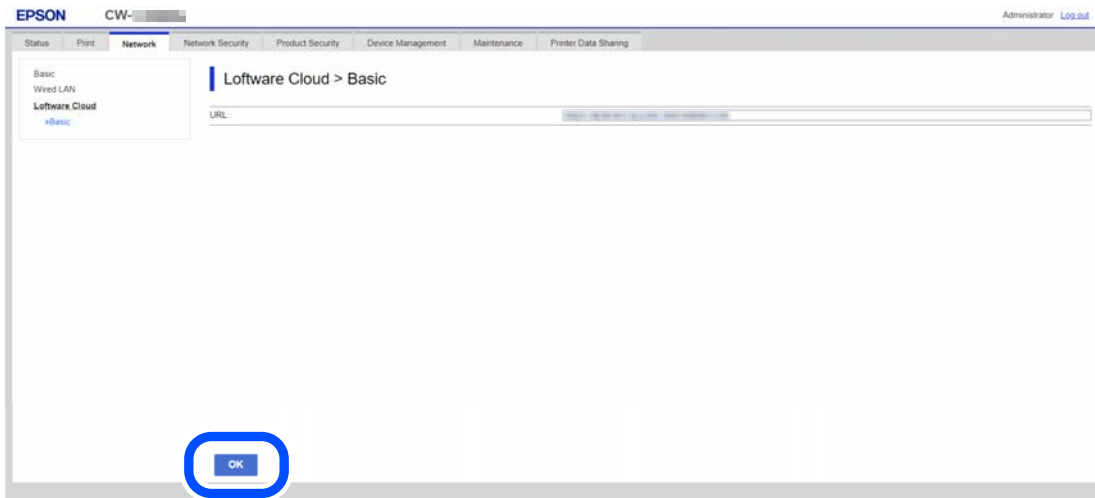

11 Check the connection results displayed on the screen.

- If the message "Setup complete" is displayed, the printer has been successfully registered.



- If an error number is displayed, the printer registration has failed. Check the solutions listed in ["Error Number List" on page 265](#). In this example, the error number is 910005.

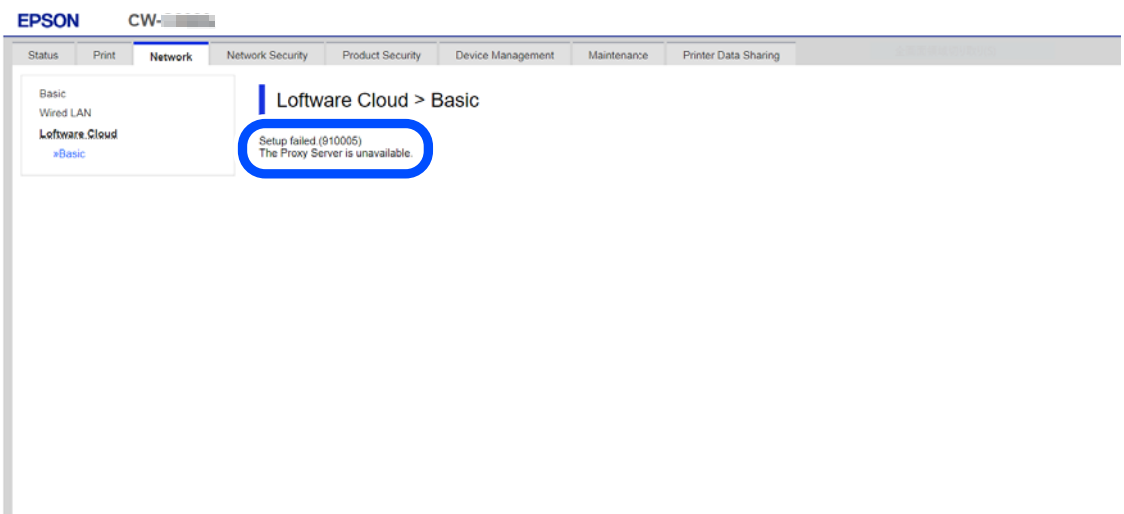

The printer's connection status can also be checked from Loftware Cloud.
[Printers] - [Cloud Printers] - [Status]

The screenshot shows the Loftware Cloud interface. The 'Cloud Printers' tab is selected. A table lists various printers. The printer 'TestLW-00000' is highlighted with a blue circle, showing a status of 'Connected'.

Name	Printer	Status
TestLW-00000	Epson CW	Connected
TestLW-00001	Epson CW	Disconnected
TestLW-00002	Epson CW	Disconnected
TestLW-00003	Epson CW	Disconnected
TestLW-00004	Epson CW	Disconnected
TestLW-00005	Epson CW	Disconnected
TestLW-00006	Epson CW	Disconnected
TestLW-00007	Epson CW	Disconnected
TestLW-00008	Epson CW	Disconnected
TestLW-00009	Epson CW	Disconnected
TestLW-00010	Epson CW	Disconnected

Registering a Printer (Epson Device Admin)

1 Open Epson Device Admin, and select [Device Configuration]. Epson Device Admin

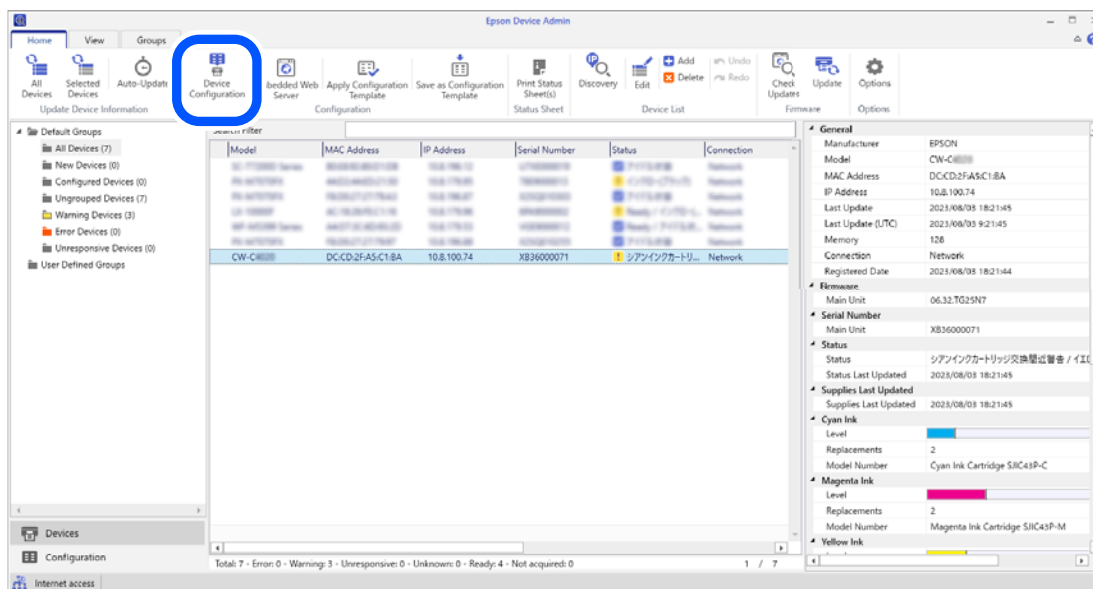

For details on Epson Device Admin, see ["Epson Device Admin"](#) on page 242.

The default administrator password is written next to "PASSWORD" on the password label affixed to the right side of the printer.

2 Check the following settings on the "Device Properties" screen.

- IP Address
- Subnet Mask
- Default Gateway
- Primary DNS Server
- Secondary DNS Server
- Proxy Server
- Proxy Server Port Number

[Network] – [TCP/IP] – [Basic]

Method for Specifying IP Address

Automatic Manual

Set using BOOTP

Set using Automatic Private IP Addressing (APIPA)

IP Address: 10 . 0 . 0 . 14

Subnet Mask: 255 . 255 . 252 . 0

Default Gateway: 10 . 0 . 0 . 1

[Network] – [TCP/IP] – [DNS]

DNS Server Address Settings

Acquire DNS server address automatically

DNS Server Addresses (order of use):

10.0.10.1

10.0.10.2

Add... Edit... Delete Up Down

[Network] – [TCP/IP] – [Internet]

Use proxy server

Proxy Server

Address: 10.0.10.201

Port: 8080

Acquire from browser information.

3 Open Software Control Center and sign in.

Please get the account information to sign in from Loftware company.

4 Select [Printers] in the tree on the left, and then select [Cloud Printers] - [Add]. Loftware Cloud

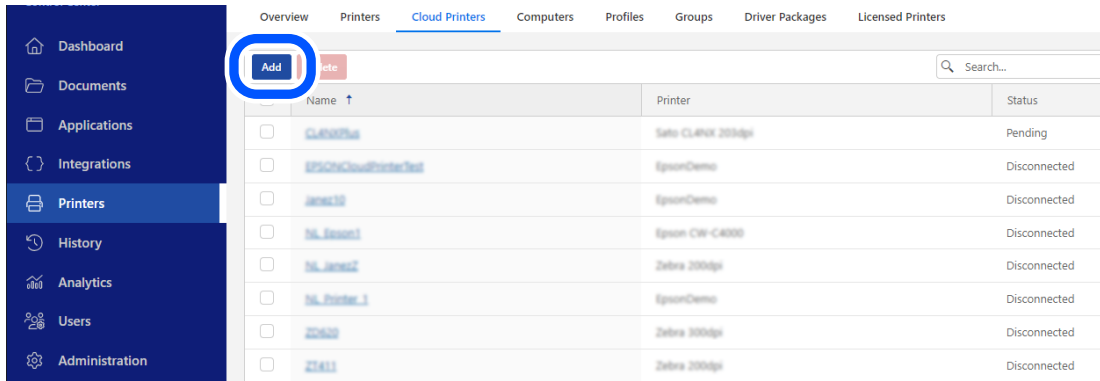

5 Set [Name] and [Printer] for the new cloud printer. Loftware Cloud



- (1) [Name] Enter the name you want to display on Loftware Cloud.
- (2) [Printer] Select the printer to set as a cloud printer.

Printer to be selected	Printer you are using
Epson CW-C8000	CW-C8000u, CW-C8000e, CW-C8010, CW-C8020, CW-C8030, CW-C8040, CW-C8050

 When you select [Printer], [Serial number] and [Server URL] will appear.

6 Open Epson Device Admin, find the serial number of the printer, and enter it into [Serial number] in Software Cloud.

Epson Device Admin

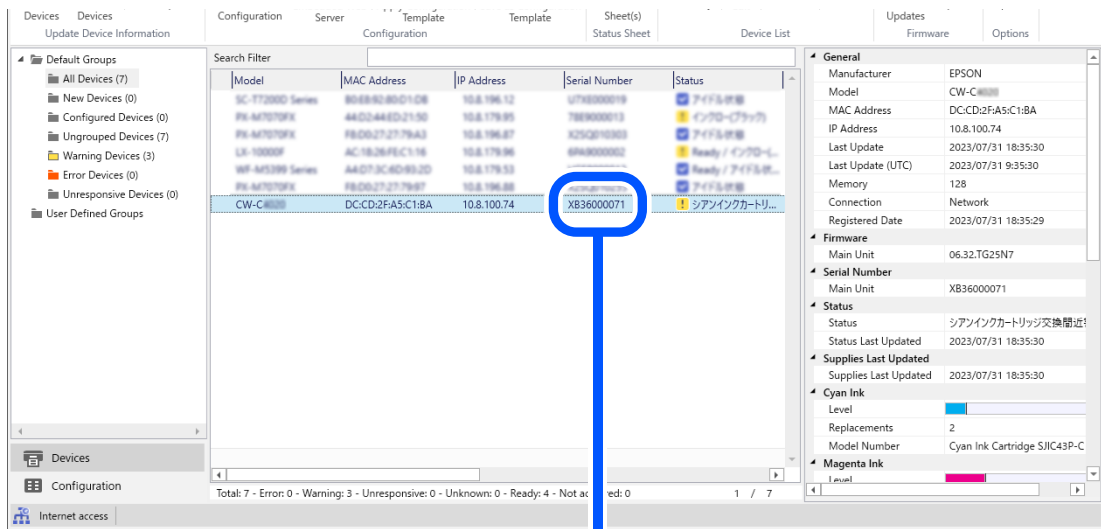

Software Cloud

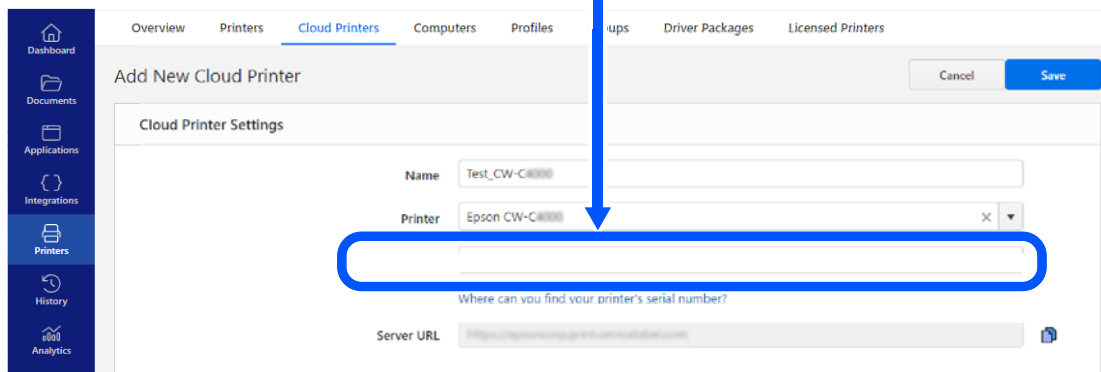

7 Select [Save].

Software Cloud

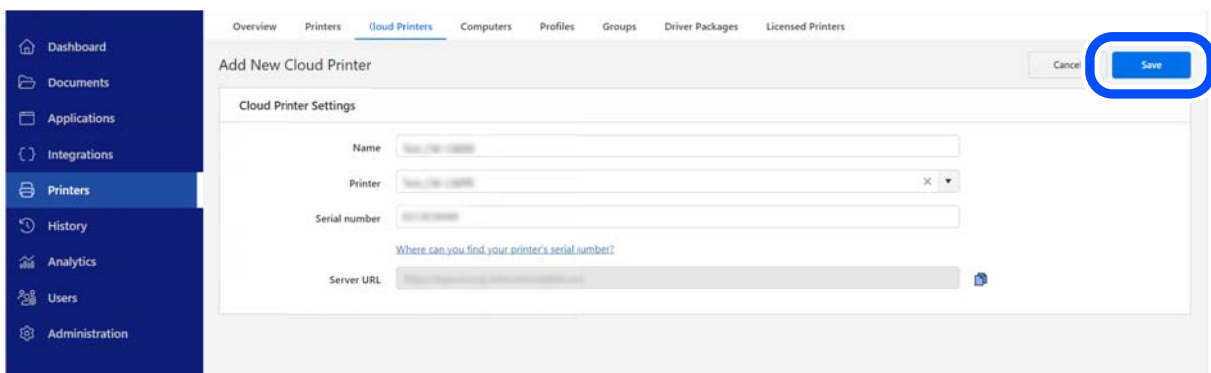

8 Select the saved printer from [Cloud Printers]. Logware Cloud

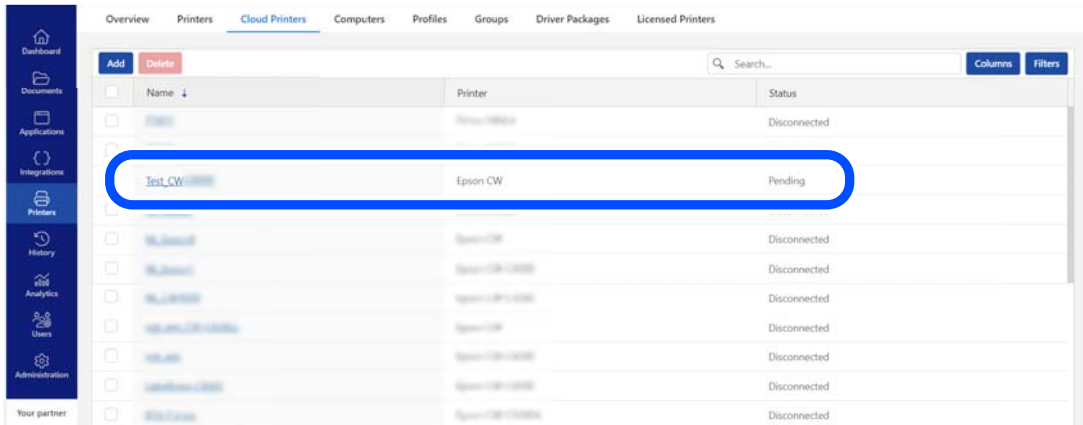

The screenshot displays the 'Cloud Printers' section of the Logware Cloud interface. A table lists various printers, with the printer 'Test_CW' highlighted by a blue circle. The table has columns for 'Name', 'Printer', and 'Status'. The 'Test_CW' printer is listed as 'Epson CW' and has a status of 'Pending'. Other printers listed are all 'Disconnected'.

Name	Printer	Status
Test_CW	Epson CW	Pending
HP_1000	HP 1000	Disconnected
HP_1000	HP 1000	Disconnected
HP_1000	HP 1000	Disconnected
HP_1000	HP 1000	Disconnected
HP_1000	HP 1000	Disconnected
HP_1000	HP 1000	Disconnected
HP_1000	HP 1000	Disconnected
HP_1000	HP 1000	Disconnected
HP_1000	HP 1000	Disconnected

9 Click the button to copy the server URL and paste it into the following field in Epson Device Admin.

[Device Configuration] - [Print/Copy] - [Label] - [Loftware Cloud] - [URL]

Loftware Cloud

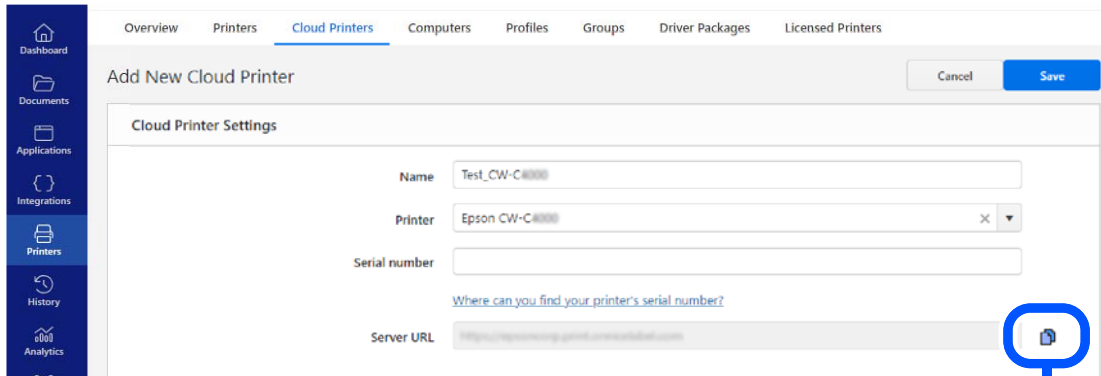

Overview Printers **Cloud Printers** Computers Profiles Groups Driver Packages Licensed Printers

Add New Cloud Printer Cancel Save

Cloud Printer Settings

Name: Test_CW-C4000

Printer: Epson CW-C4000

Serial number:

[Where can you find your printer's serial number?](#)

Server URL: 

Epson Device Admin

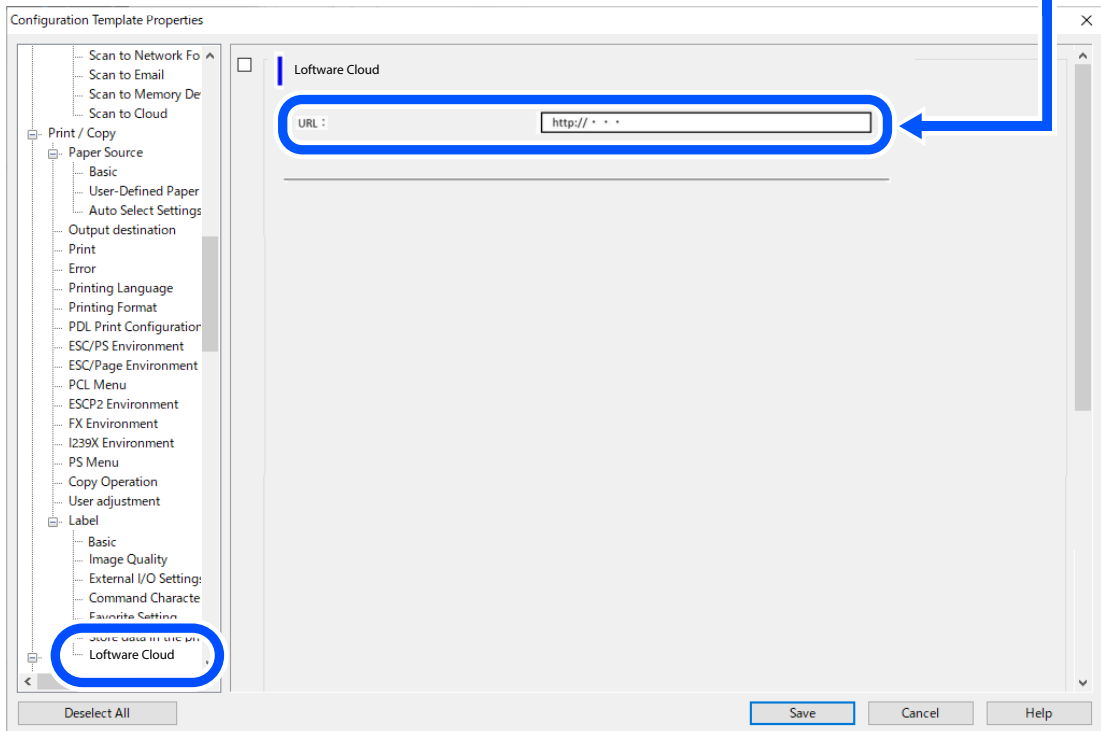

Configuration Template Properties

- Scan to Network Fo
- Scan to Email
- Scan to Memory De
- Scan to Cloud
- Print / Copy
 - Paper Source
 - Basic
 - User-Defined Paper
 - Auto Select Settings
 - Output destination
 - Print
 - Error
 - Printing Language
 - Printing Format
 - PDL Print Configuration
 - ESC/PS Environment
 - ESC/Page Environment
 - PCL Menu
 - ESCP2 Environment
 - FX Environment
 - I239X Environment
 - PS Menu
 - Copy Operation
 - User adjustment
- Label
 - Basic
 - Image Quality
 - External I/O Setting
 - Command Characte
 - Favorite Setting
 - Store data in the pr
 - Loftware Cloud**
 - URL:

Deselect All Save Cancel Help

10 Select [Save].

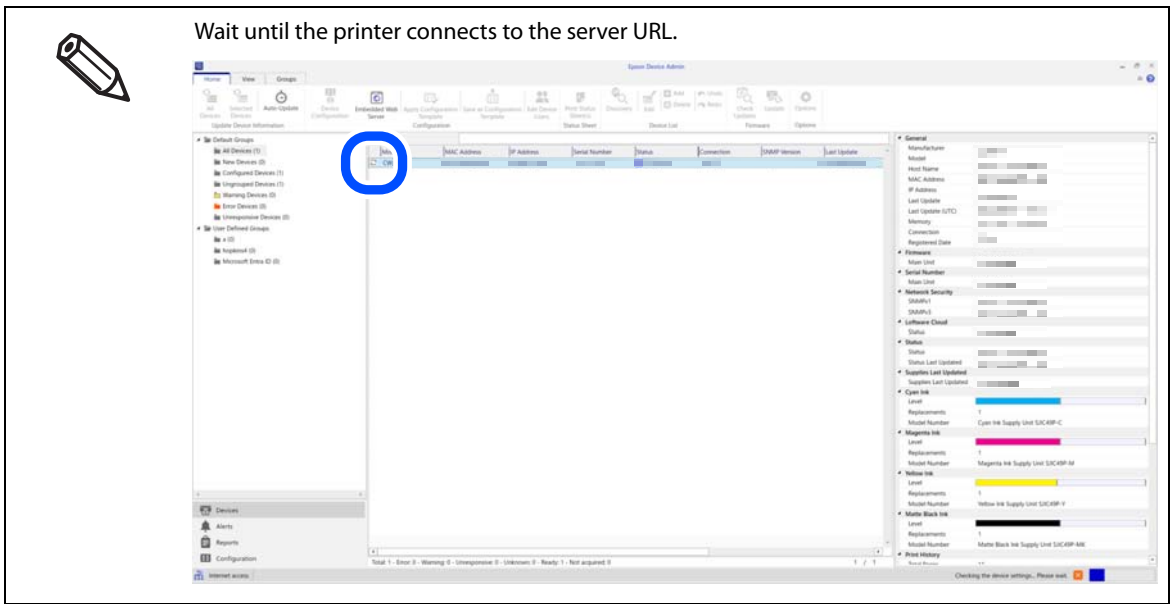

11 Check [Software Cloud] - [Status] on the device details screen.

- If "Enabled" is displayed, the printer has been successfully registered.

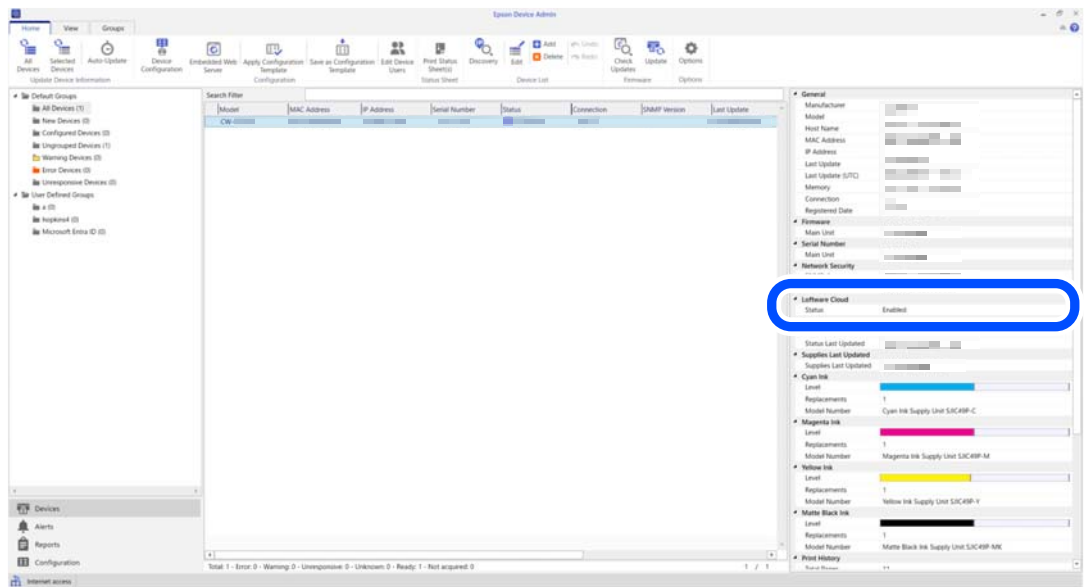

- If "Disabled" or an error number is displayed, the printer registration has failed. Check the solutions listed in "Error Number List" on page 265. In this example, the error number is 910005.

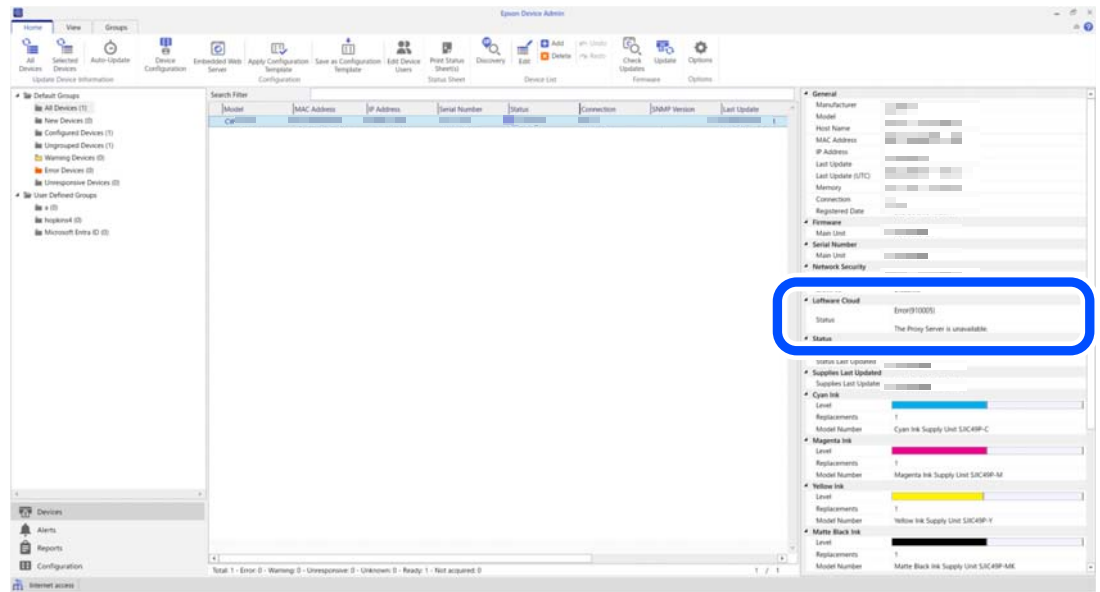

The printer's connection status can also be checked from Loftware Cloud. [Printers] - [Cloud Printers] – [Status]

Loftware Cloud

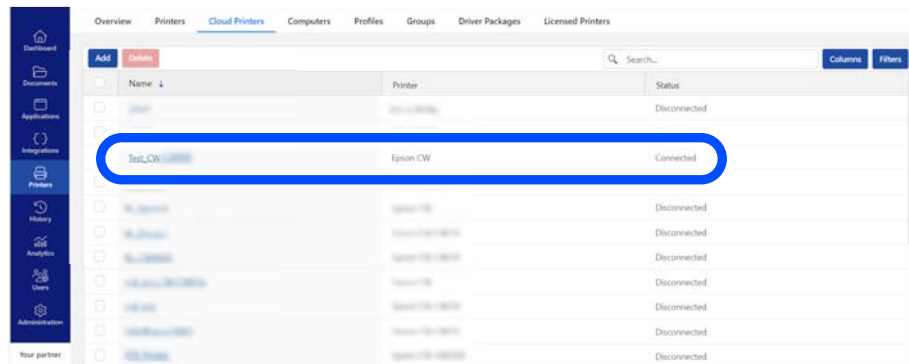

How to Check the Printer Connection Status

The connection status between the printer and Software Cloud can be checked from Software Cloud, Web Config, and Epson Device Admin.

Checking from Software Cloud

Select [Printers] from the tree on the left of Software Cloud. The printer's connection status will be displayed under [Cloud Printers] – [Status].

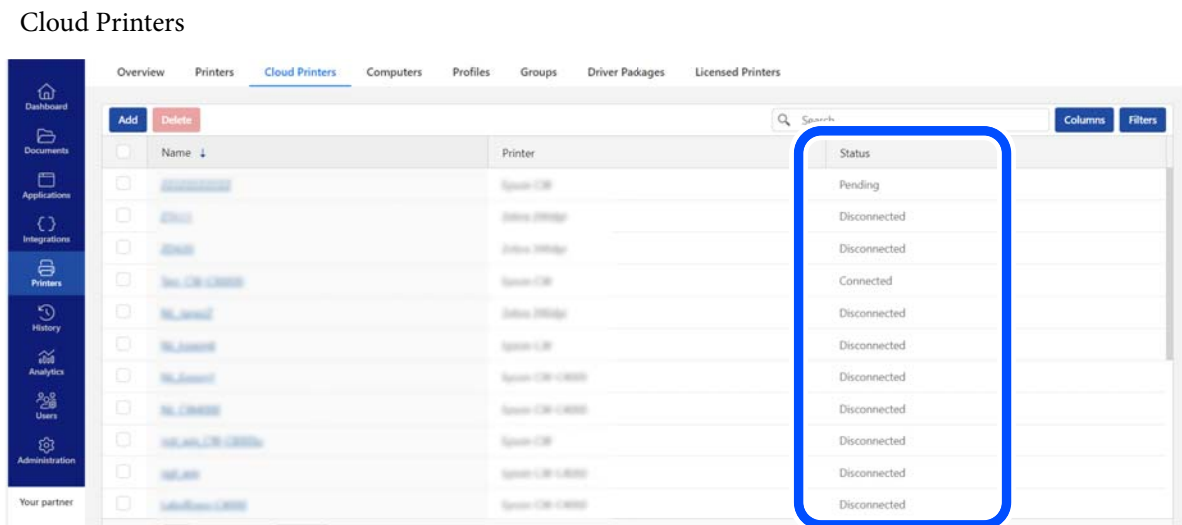

Message	Explanation
Connected	The printer is ready to print. The printer is connected to the Software Cloud server and has been successfully authenticated.
Pending	Printing from the printer is not possible. The printer has never been able to connect to the Software Cloud server.
Disconnected	Printing from the printer is not possible. The following are possible causes. <ul style="list-style-type: none"> • The printer has connected to the Software Cloud server, but is now disconnected. • The Software Cloud server has failed to authenticate the printer. • The printer is not turned on.

If "Pending" or "Disconnected" is displayed in the "Status" column, check the error number on the Web Config or Epson Device Admin screen, and take action according to the error number.

["Checking from Web Config" on page 262](#)

["Checking from Epson Device Admin" on page 264](#)

Checking from Web Config

- 1 Open Web Config and click [Log in] to log in.

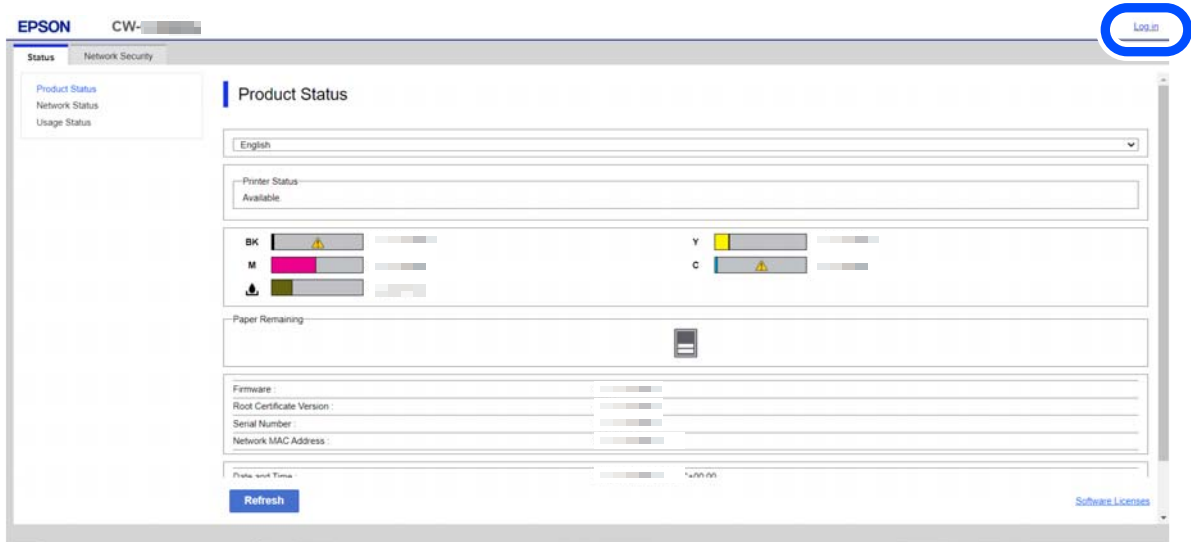

- 2 Check the [Software Cloud Status] field on the [Status] screen.
 - If the message "Connection test was successful" is displayed, the printer is connected.

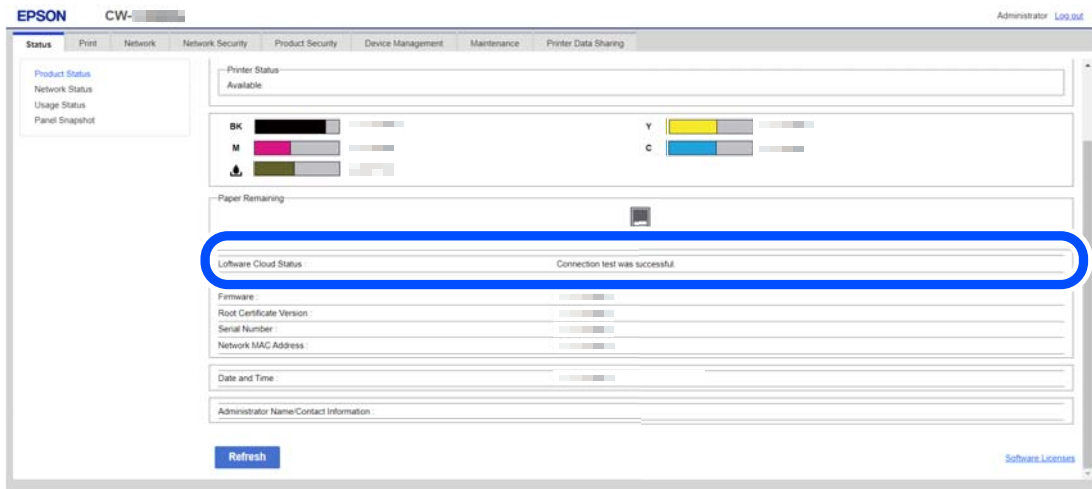

- If an error number is displayed, the printer is not connected. Check the solutions listed in "[Error Number List](#)" on page 265. In this example, the error number is 910005.

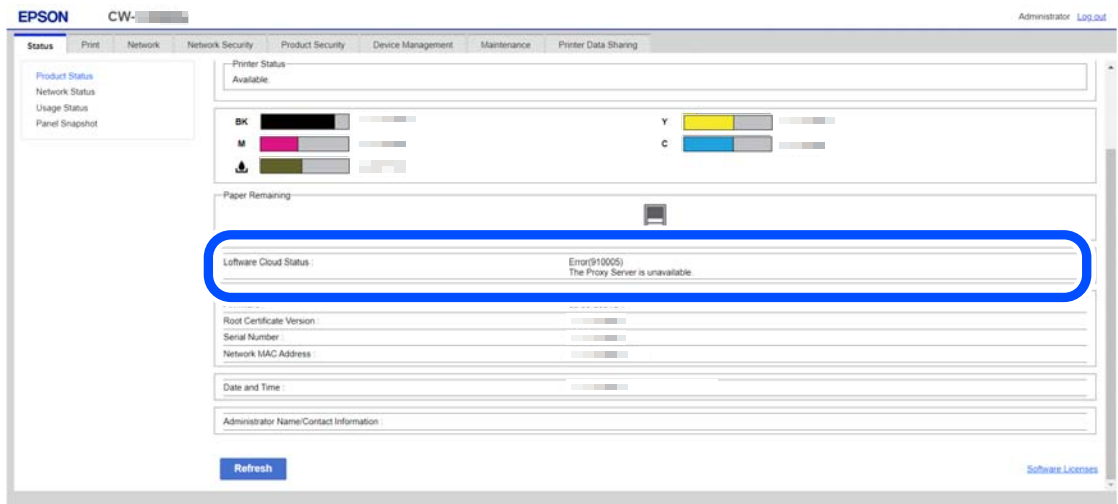

Checking from Epson Device Admin

1 Start Epson Device Admin.



For details on Epson Device Admin, see ["Epson Device Admin" on page 242](#).

The default administrator password is the string on the password label on the right side of the printer.

2 Check [Loftware Cloud] - [Status] on the device details screen.

- If "Enabled" is displayed, the printer is connected.

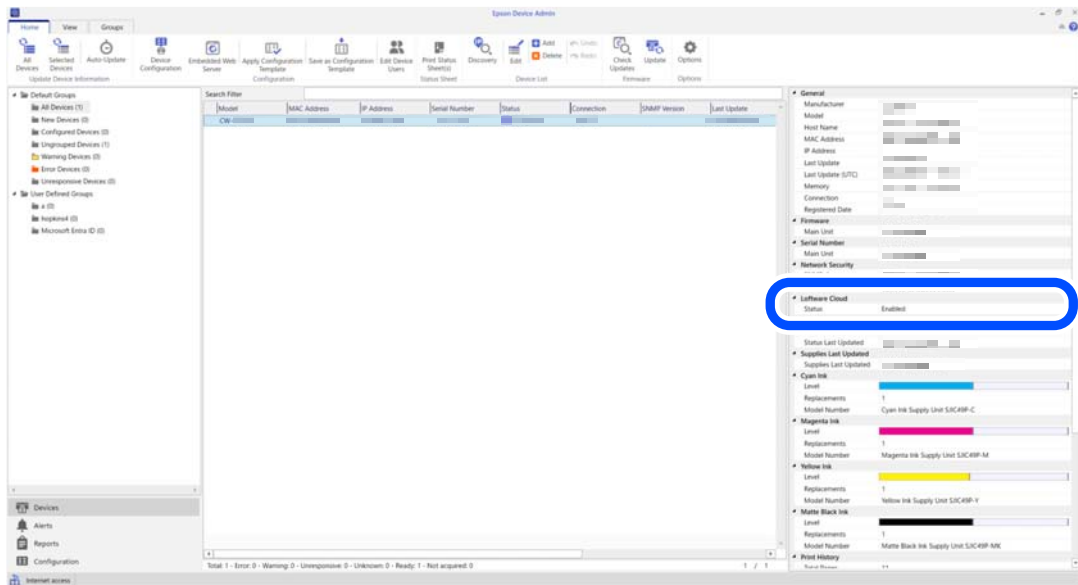

- If "Disabled" or an error number is displayed, the printer registration has failed. Check the solutions listed in ["Error Number List" on page 265](#). In this example, the error number is 910005.

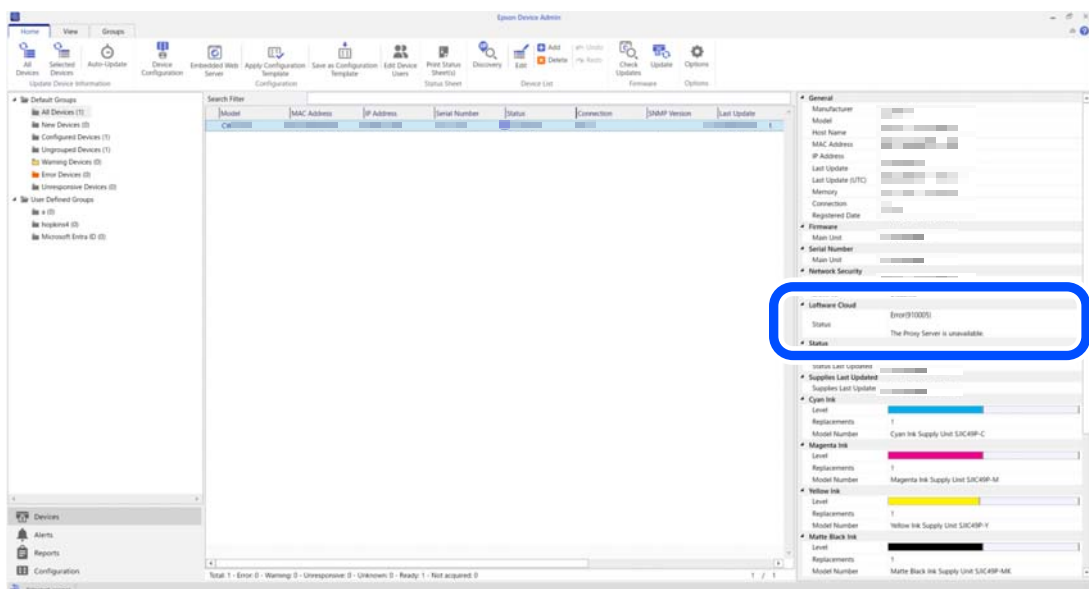

Error Number List

Check the error number regarding Loftware Cloud and take action according to the number.

Error Number	Descriptions
910002, 910010, 910011	Internet or service is not available. Check the LAN cable connection and network settings and try again later.
910003	DNS server is not available. Check if the DNS server settings are correct and try again later.
910004	DNS cannot resolve the domain name. Check your Internet connection and domain name and try again later.
910005	Connection to the proxy server has failed. Check if the proxy server settings are correct and try again later.
910006	The connection to the proxy server has been disconnected. Check the HTTPS port permission settings or proxy authentication and try again later.
910007	The Loftware Cloud server is failing to authenticate the printer because the printer's date or time is not set correctly. Match the printer's date and time to the server's date and time. The date and time can be set on the control panel, in Web Config, or in Epson Device Admin.
910008, 910009	Loftware Cloud service is not available. Try again after a while. If the problem persists, please contact Loftware Cloud support.
910012	The Loftware Cloud server has failed to authenticate the printer. Re-register the printer after a while. If the problem persists, please contact Loftware Cloud support with the error ID and message shown on the screen.

Troubleshooting

If you failed to connect your printer to the server as a cloud printer, check the following.

1 Check if the printer's network settings are correct. The following network-related items must be configured correctly. In particular, make sure that the DNS server and proxy server settings are correct.

- IP Address
- Subnet Mask
- Default Gateway
- Primary DNS Server
- Secondary DNS Server
- Proxy Server
- Proxy Server Port Number

2 Make sure that the printer serial number entered into [Cloud Printer Settings] - [Serial Number] in the Software Control Center does not contain spaces or line feed codes.

If you copied the printer serial number from Web Config or other source when registering the cloud printer, you may have inadvertently included spaces or line feed codes and unintentionally entered an incorrect serial number that includes them.

Spot Color Settings

[Spot Color Settings] allows you to change a specified color to another specified color. First create the color conversion setting file, then when printing, specify the setting file to print with the color conversion applied. Follow the procedure below to create the color conversion setting file.



The printer converts all the portions of print data that use the specified RGB settings into the target color. If unintended portions are converted into the target color, slightly change the RGB settings of the portions of the original print data.

Creating Spot Color Setting File

1 Check the RGB settings of a color you want to convert into another color in the print data.

The check method for Microsoft Paint is explained here as an example.

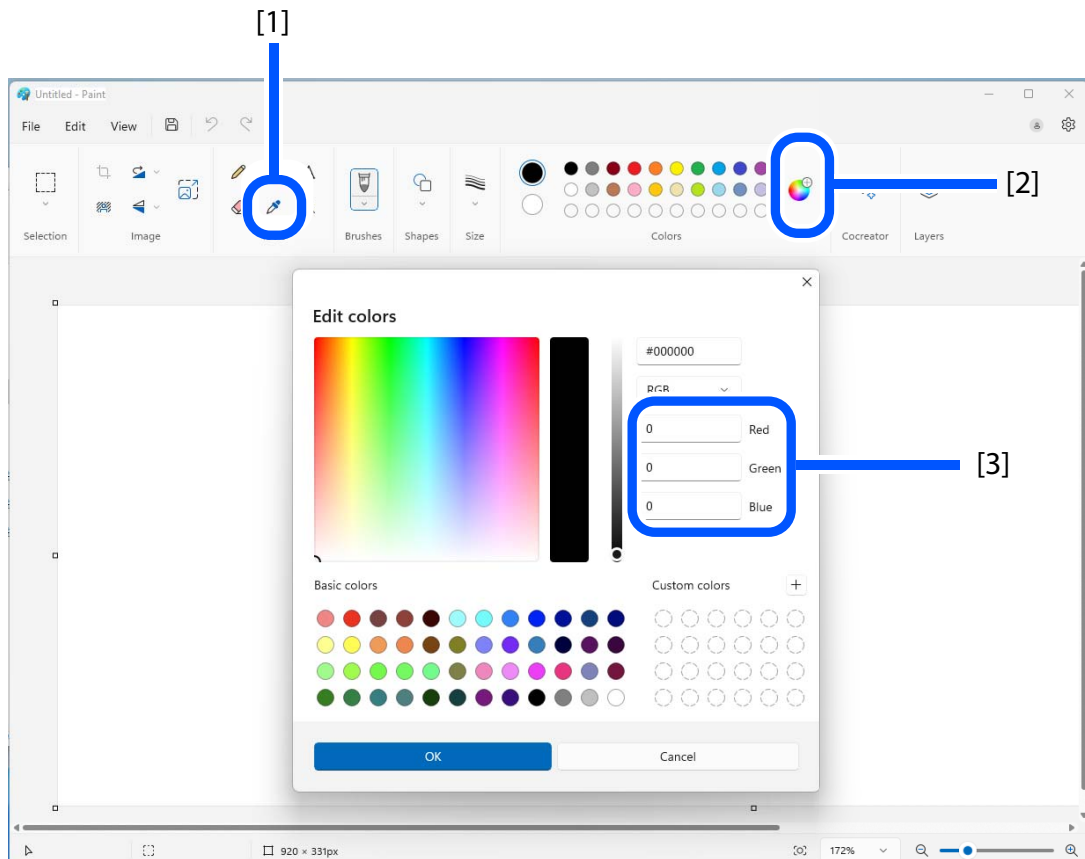

- [1] Select the Picker tool, and then click on a color you want to check.
- [2] Click the [Edit Colors] button to display the Edit Colors window.
- [3] Check the RGB settings of the selected color, and write them down.



The method to check the RGB settings differs by graphic software to another. See the manual or help of the software you use.

2 Determine RGB settings of a target color.



When determining the desired color, we recommend using the "Color Tone Matching Assistant" which can be downloaded from the following website.

For customers in North America, go to the following web site:

<https://www.epson.com/support/>

For customers in other countries and regions, go to the following web site:

<https://epson.sn>

Color Tone Matching Assistant lets you enter the RGB settings of the original color, creates some sample colors by slightly changing the original RGB settings, and then lets you print the samples. You can choose a target color and know its RGB settings on the printout. For more details, see "Color Tone Matching Assistant User's Guide".

Color Tone Matching Assistant

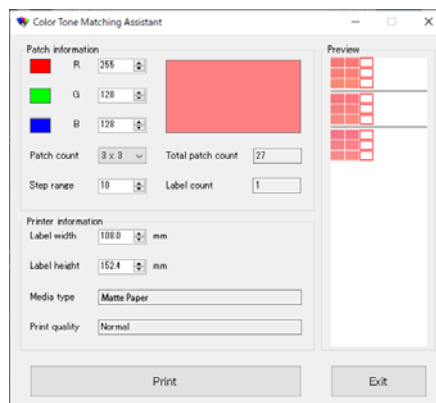

Example of the Sample Colors

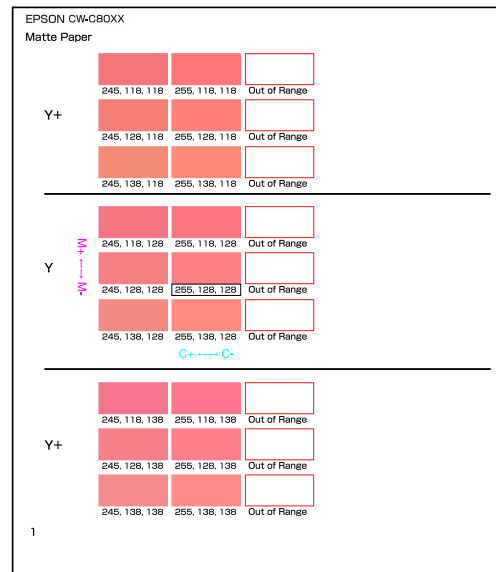

If you have set font replacement, the sample pattern in the Color Tone Matching Assistant may not be printed normally. Unset font replacement and then print.

3 Start PrinterSetting.

("How to Start PrinterSetting" on page 186)

4 Select [Store data in the printer].

5 Click [Create] button in the [Spot Color Setting] field.

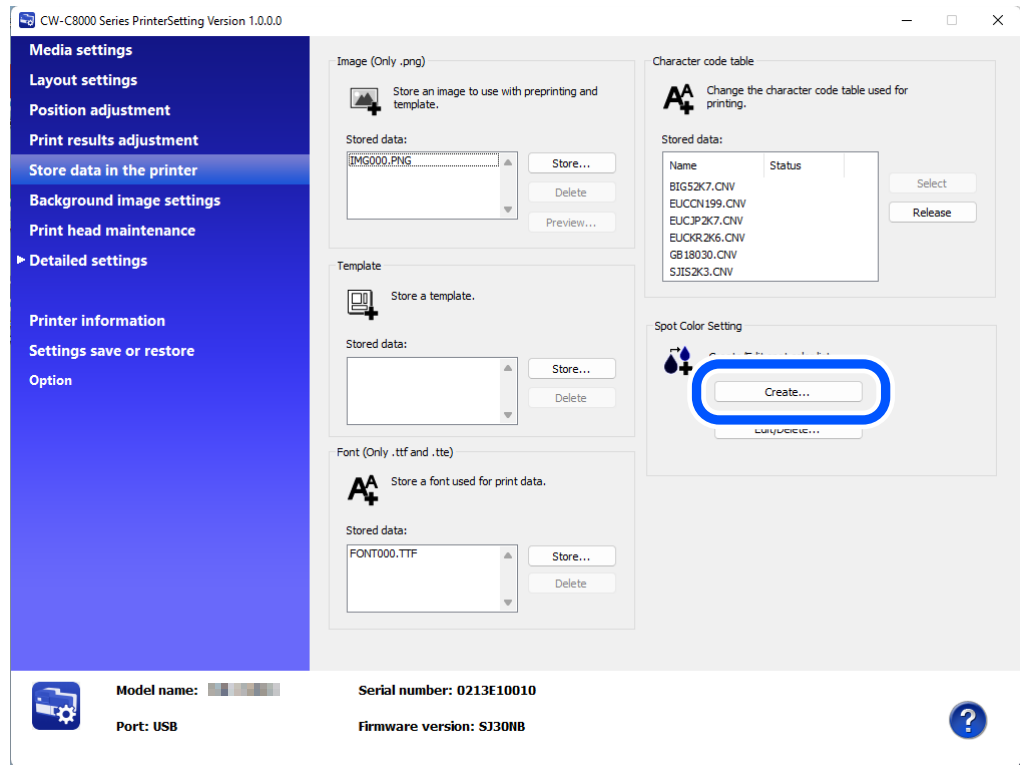

6 Enter the original RGB settings and the target RGB settings.

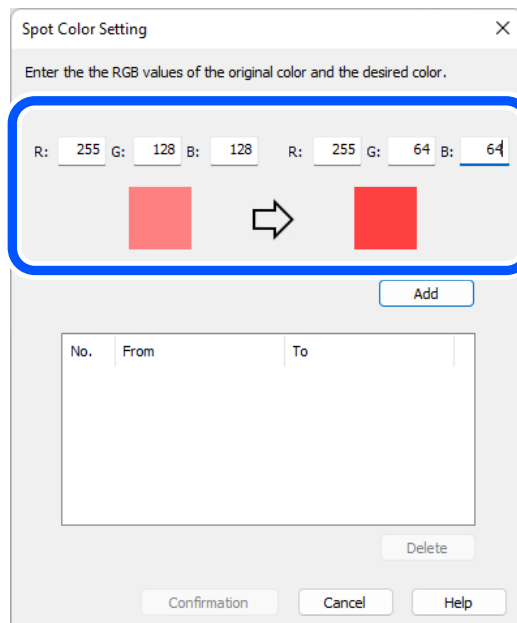

- 7 Click [Add].**
The specified pair of RGB settings will be added in the box.

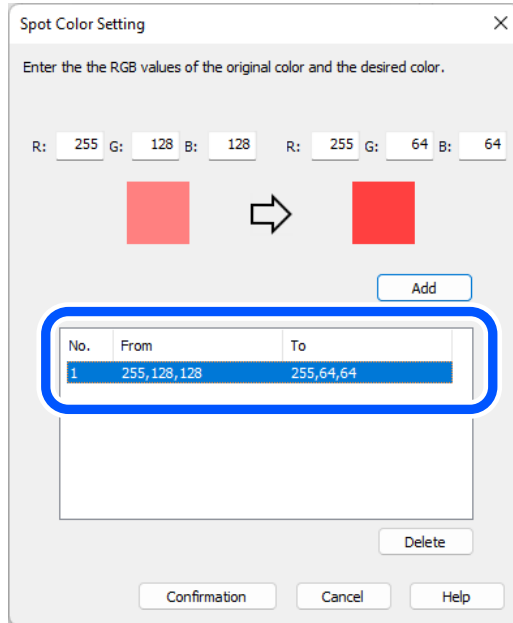

- 8 Click [Confirmation].**
A window to enter a name for the spot color setting is displayed.

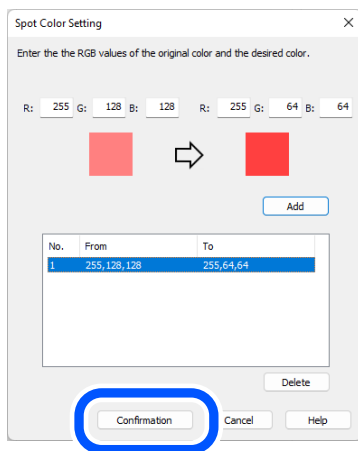

- 9 Enter a name for the setting file, then click [OK].**

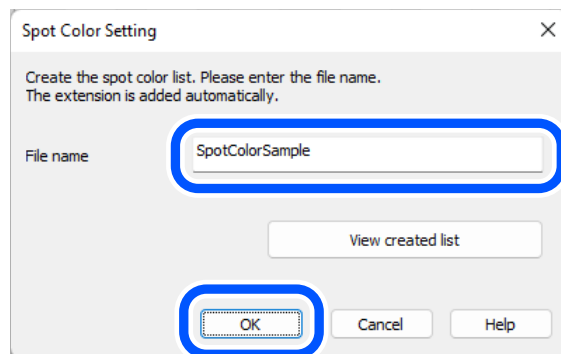

- 10** When you select [OK] on a successfully saved dialog box, the [Created spot color list] window appears.

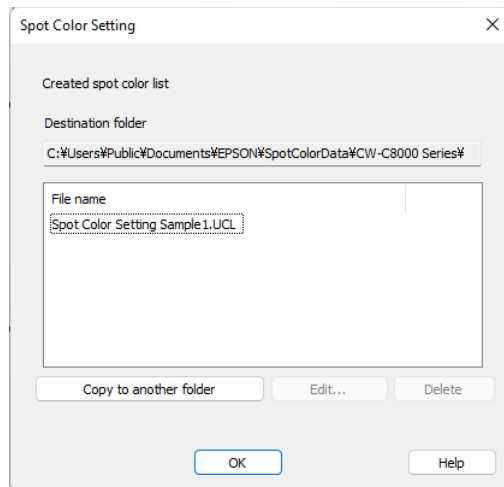

If you want to copy the file to another location, click [Copy to another folder].

Creating spot color setting file is now complete.

Printing using the Spot Color Setting File

- 1 Open the printer driver window.
- 2 Select [Spot Color Settings] on the [General] window.

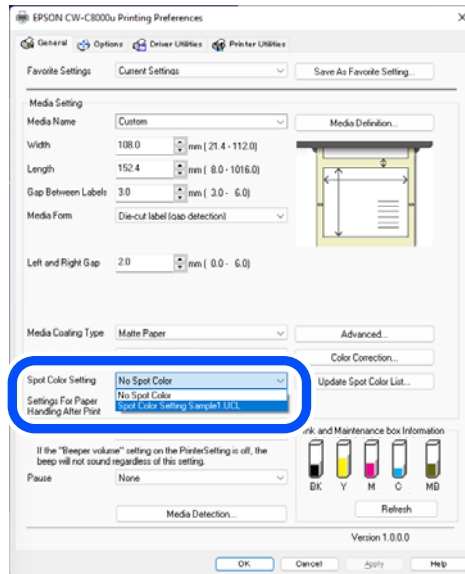

- 3 From the pull-down menu, select a spot color setting file you want to use.



To change the folder to view, click [Update Spot Color List] and change the folder.

- 4 **Print the file.**
The printer driver prints the file after performing the color conversion as specified in the setting file.

Printing using the spot color setting file is now complete.

Color Correction

There are the following three methods for color correction.

- Setting on the printer
- Setting using OS
- Setting using an application software

Change the printer driver's [Color Correction] setting according to the color correction engine used.

- When setting on the printer
Select from [EPSON Vivid Color], [Epson Preferred Color], and [Epson Standard].
- When setting using OS
Select [ICM] for Windows, or [ColorSync] for Mac.
- When setting using an application software
Select [No Color Adjustment].

Relationship Between Driver Settings, Color Correction Methods, and Spot Color Settings

The color of the print result varies depending on the menu settings on the driver.

There are two menus on the driver for changing the color of the print result: [Color Correction] and [Spot Color Setting].

[Color Correction] changes the overall color, and there are color correction engines in the printer, in the OS, and in certain applications. The setting selected in [Color Correction] in the printer driver specifies which color correction engine to use and also passes input parameters to each color correction engine.

Only one setting can be selected for [Color Correction Method]. Therefore, no color correction engine in the printer, in the OS, or in a particular application will be used at the same time, but only one of them will be used.

[Spot Color Setting] replaces the specified specific color (= the original color) with another color (= the target color), and there is a color replacement engine in the driver and in the printer.

When [Color Correction] is set to use the printer's internal color correction engine, which are [Epson Vivid Color], [EPSON Standard Color], or [Epson Preferred Color], color correction can be performed in combination with [Spot Color Setting].

If [Color Correction Method] is set to [ICM] or [No Color Adjustment], color correction cannot be performed in combination with [Spot Color Setting].

This is because if the application or OS color correction is performed first, the RGB values before conversion specified in [Spot Color Setting] will be changed, and the printer driver will not be able to find the part to be converted.

Setting on the driver		By What is the Color Correction Performed?
Menu	Selection	
Color Correction	Epson vivid color	Color correction engine in the printer
	Epson Standard	Color correction engine in the printer
	Epson Preferred Color	Color correction engine in the printer
	ICM	Color correction engine in the OS
	No Color Adjustment	Assumption that color correction is performed by an application software
Spot Color Setting	No Spot Color	None
	File name of the spot color list	Color replacement engine for spot colors in the driver

Color Correction Method Options by Model

ColorWorks series printers have different internal color correction methods supported by each model. Selecting the same color correction method may produce similar shades*.

* The same color shade will not be achieved because different models use different inks.

	Color Correction Method Options provided by Printer		
	EPSON Vivid Color	Epson Preferred Color	Epson Standard
CW-C8000 Series	✓	✓ (default)	✓
TM-C7500 Series	--	✓ (default)	✓
CW-C4000 Series	✓ (default)	✓ *	--
CW-C6000/C6500 Series	✓ (default)	--	--
TM-C3500 Series	--	✓ (default)	✓

✓ : supported

✓ *: supported only with some combinations of paper and print quality

--: Not supported

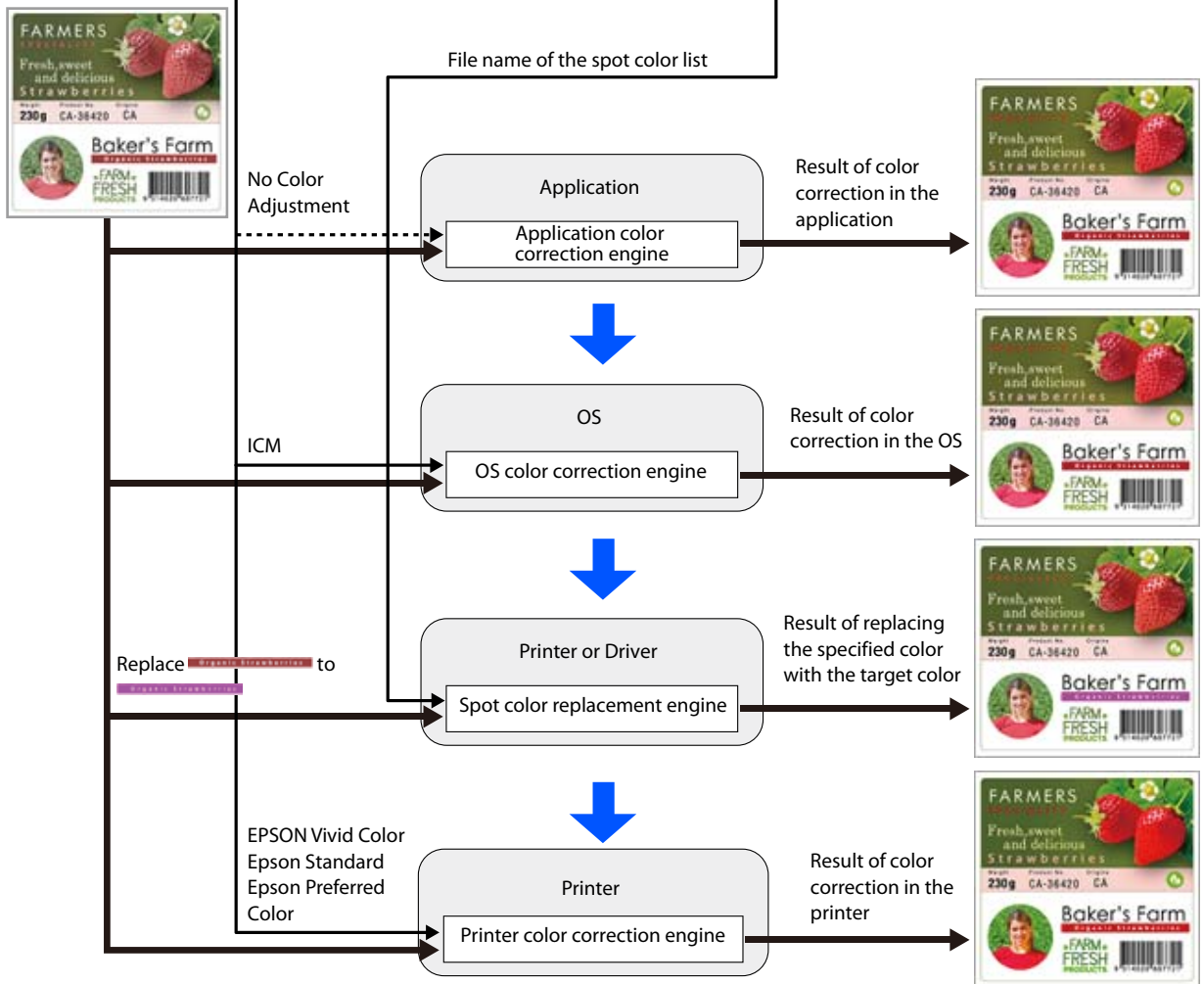
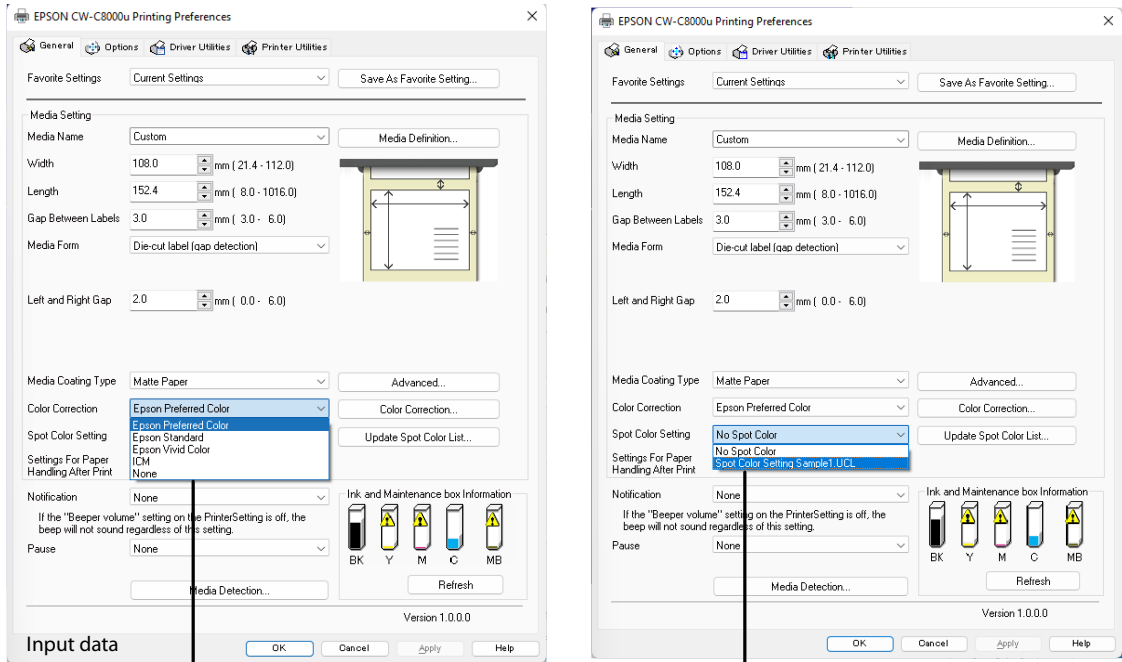

CAUTION The image data is a representation of the concept of color correction, and is not the actual data before and after color correction.

Using the Printer's Color Correction Engine

EPSON Vivid Color

“Epson Vivid Color” conforms to the Adobe RGB color space for images. It has a wider color reproduction range than sRGB, but in order to bring the colors of the print result closer to the monitor, you need to prepare a monitor that is compatible with Adobe RGB.

Epson Standard

“Epson Standard” conforms to the sRGB color space for images. The color reproduction range is narrower than Adobe RGB, but the colors of printed results are close to those shown on common monitors.

If you have printed using [Epson Standard] on a TM-C7500 series printer, you can print with similar tints with this printer by selecting [Epson Standard].

Epson Preferred Color

“Epson Preferred Color” conforms to the sRGB color space for images. The color reproduction range is narrower than Adobe RGB, but the colors of printed results are close to those shown on common monitors. Unlike EPSON standard colors, CMY ink colors can be printed as they are, enabling printing with ink pure colors.

If you have printed using [Epson Preferred Color] on a TM-C7500 series printer, you can print with similar tints with this printer by selecting [Epson Preferred Color].

Adjustment method

If you select [Epson Vivid Color], [Epson Standard], or [Epson Preferred Color] from the [Color Correction] menu, and click the [Color Correction] button, the [Color Correction] window is displayed.

Change the color settings comparing the [Original Picture] image and the [Preview] image.

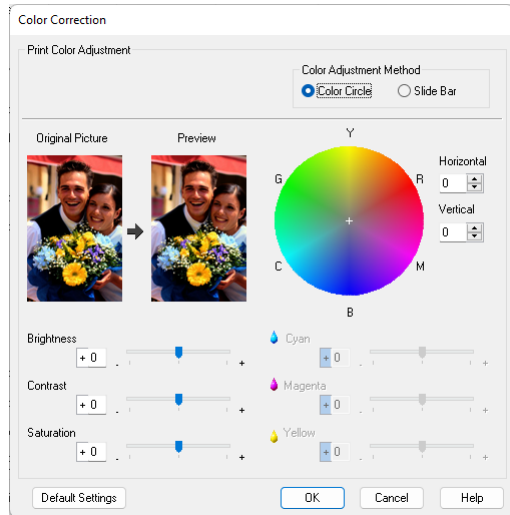
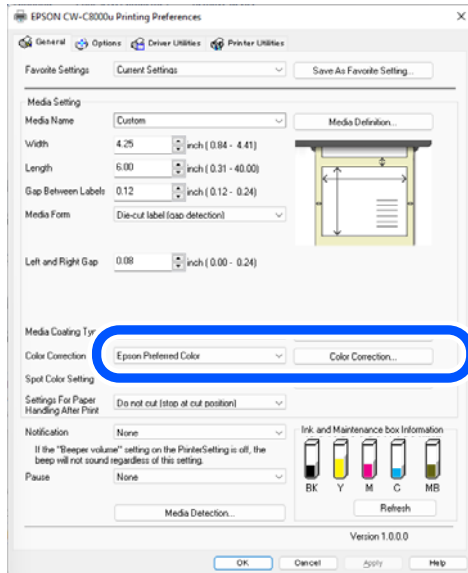

Item		Description
Brightness		Lets you adjust brightness of the entire image.
Contrast		Adjust the contrast of the entire image. When the contrast is increased, bright portions become more bright, and dark portions become more dark. When the contrast is decreased, difference between light and dark is reduced.
Saturation		Lets you adjust saturation (vividness) of the entire image. When the saturation is increased, the feel of the vividness of the image is increased. The more the saturation is decreased, the more the image becomes achromatic closing to gray.
Color Adjustment Method	Color Circle	Click on the circle to adjust the color. You can also adjust color by entering values in the [Horizontal and [Vertical] boxes.
	Slide Bar	You can move the Cyan, Magenta, and Yellow slide bars to adjust color.

Using the OS's Color Correction Engine

ICM (for Windows users)

ICM (Image Color Management) is a Windows color control function to match apparent color between different devices such as a monitor and a printer. Apparent color on the monitor and on the printout is matched based on ICC profiles.

An ICC profile is a file that describes characteristics of the device such as a monitor and a printer according to ICC (International Color Consortium) standards.

However, since the color space of a four-color printer is narrow comparing to that of a monitor, it is impossible to accurately match colors on the monitor with printouts.

When you click the [Color Correction] button with [ICM] selected, the ICM window appears.

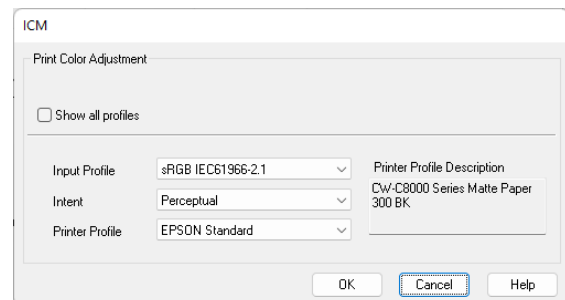
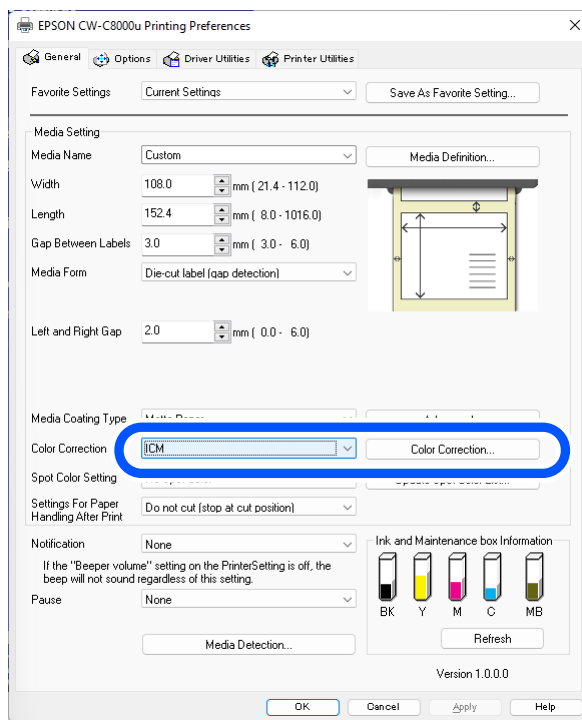

Item		Description
Show all profiles		<p>When the printer driver is installed, ICC profiles for Epson genuine paper are also installed. The ICC profiles include all combinations of [Media Coating Type] and [Print Speed] for each Epson paper.</p> <p>Since the check box for this item is not checked by default, the [Input Profile] setting is fixed to [sRGB IEC61966-2-1], and the [Printer Profile] setting is fixed to [EPSON Standard]. With the default settings, one of the ICC profiles for Epson paper is automatically selected according to the [Media Coating Type] and [Print Speed] settings.</p> <p>Select this check box when using paper other than Epson genuine paper and you have installed an ICC profile for the paper.</p> <p>When the check box is selected, the pull-down menu of [Input Profile] and [Printer Profile] shows all profiles installed on the system. Select the target ICC profile from the [Printer Profile] menu.</p>
Input Profile		<p>Select a profile for a display device.</p> <p>Normally, only "sRGB IEC61966-2-1", which is the default of Windows OS, is displayed.</p>
Intent	Saturation	Color is converted keeping the saturation.
	Perceptual	Color is converted keeping natural-looking image. Select this when color space of the image is wide.
	Relative Colorimetric	Color is converted so that chromatic coordinate between the original data and the print data matches, and the white point (color temperature) also matches between them. This method is used a lot for color matching.
	Absolute Colorimetric	Color is converted assigning both the original and print data to absolute chromatic coordinate. The white point (color temperature) of the original and print data is not corrected. Use this method to print an image that has a specific color such as a corporate logo.
Printer Profile		<p>Select a printer profile that matches the media you use. Normally, only [EPSON Standard] is displayed. [EPSON Standard] automatically selects an ICC profile for Epson genuine paper that matches the [Media Coating Type] and [Print Speed] settings on the printer driver.</p>

ColorSync (for Mac users)

“ColorSync” is a Color Matching engine on macOS. That is similar to ICM on Windows.

The following describes how to set an ICC profile using ColorSync taking Adobe Photoshop (hereafter, Photoshop) and Preview as examples.

When printing from Photoshop

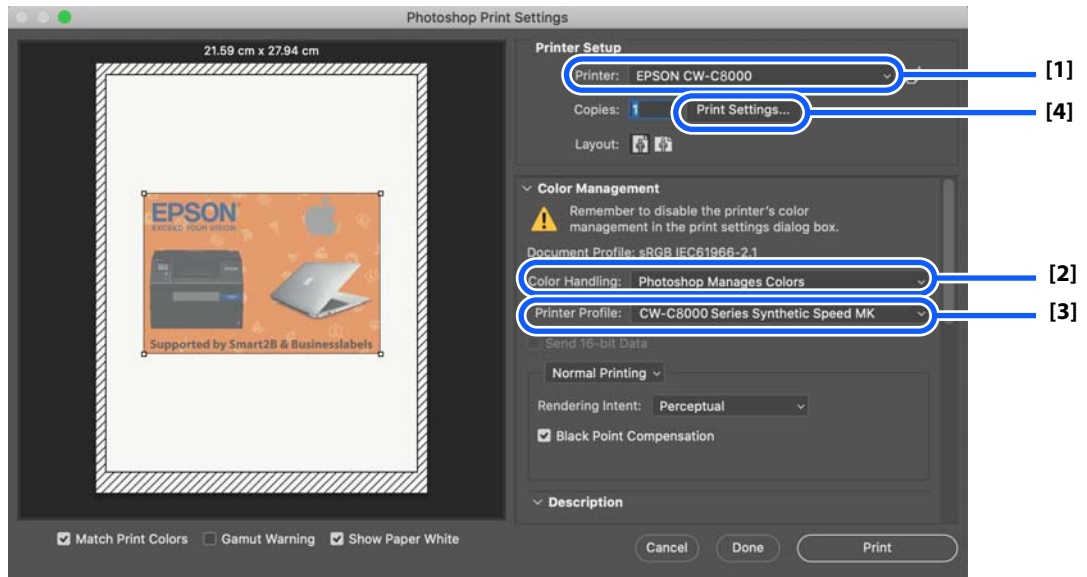

- 1 Select the printer in [Printer].
- 2 In the [Color Handling] menu, select [Photoshop Manages Colors].
If you select [Printer Managed Colors], the ICC profile settings are not reflected in print results.
- 3 Select the appropriate ICC profile under [Printer Profile].
- 4 Click [Print Settings] to configure print settings in the printer driver.
You cannot change [Color Matching] and [Color Options].

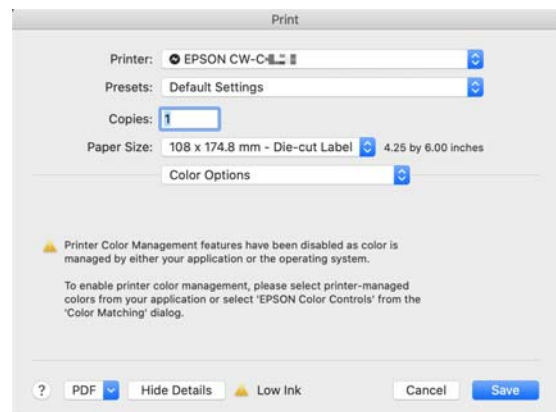
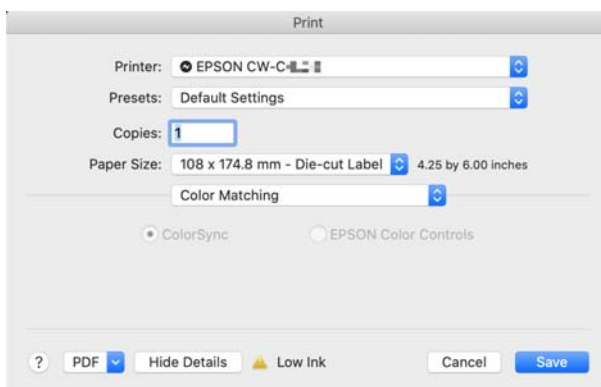

- 5 Configure other print settings in Photoshop's print window.
- 6 Click [Print] button.

When printing from Preview

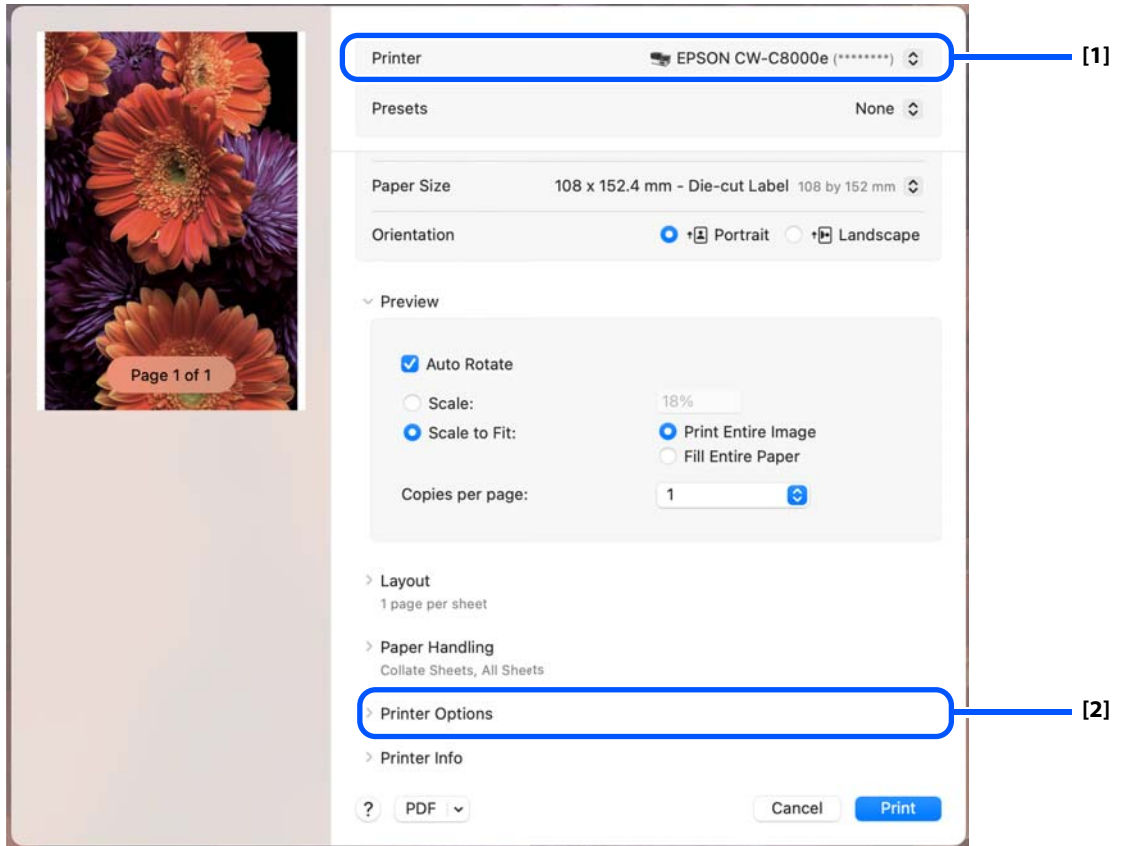

- 1 Select the printer in [Printer].

2 Select [ColorSync] under [Color Matching] and select an appropriate ICC profile under [Profile].

If you select [Automatic], the ICC profile provided by Epson is automatically selected.

Selecting [Other Profiles] displays the [Select ColorSync Profile] window, which allows you to select other ICC profiles.

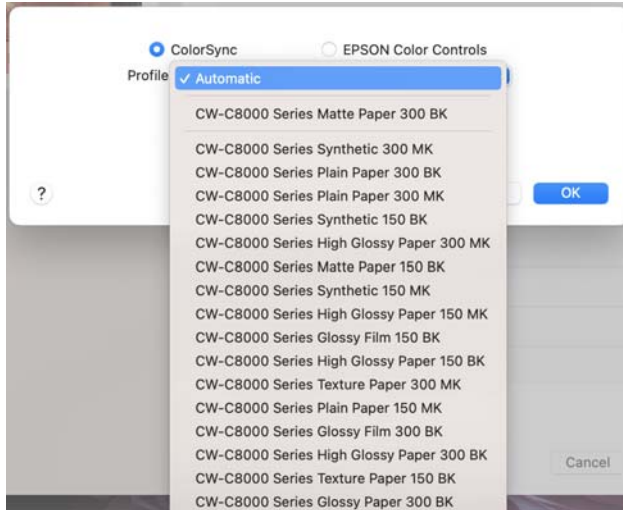

3 Select other print settings.

4 Click [Print] button.

When printing from Acrobat Reader



Notes on using ColorSync

- The PDF data must be RGB data. CMYK data cannot be corrected properly.
- If a source profile (input profile) has not been embedded in the print data, “sRGB IEC61966-2.1” is automatically applied as the source profile.
- The rendering intent is fixed to “Perceptual”.

- 1 Select the printer in [Printer:], and then click [Printer...] at the bottom of the screen.

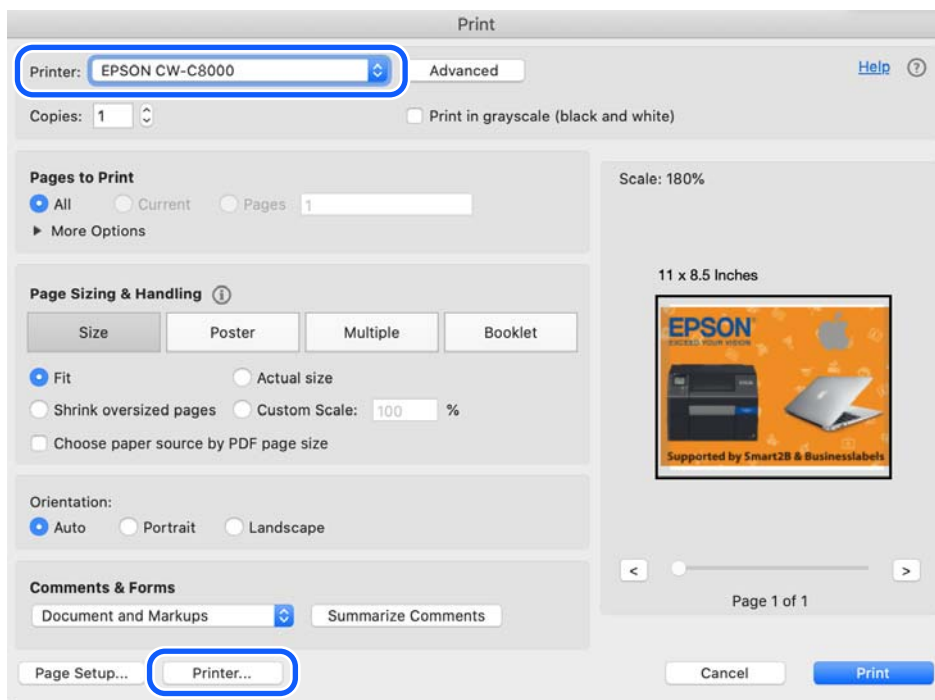

- 2** Select [ColorSync] under [Color Matching] and select an appropriate ICC profile under [Profile].

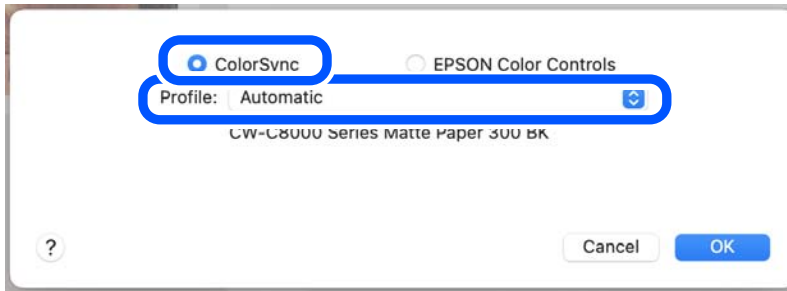

The default profile setting is [Automatic] which automatically selects an ICC profile provided by Epson. Select [Other Profiles...] to display the ColorSync profile selection screen and select a target ICC profile by yourself.

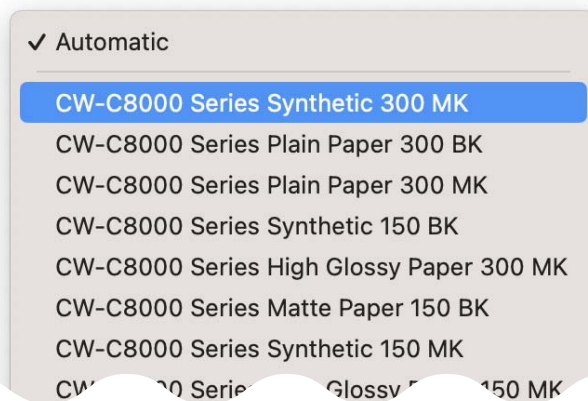

- 3** Select other print settings.

- 4** Click [Advanced].

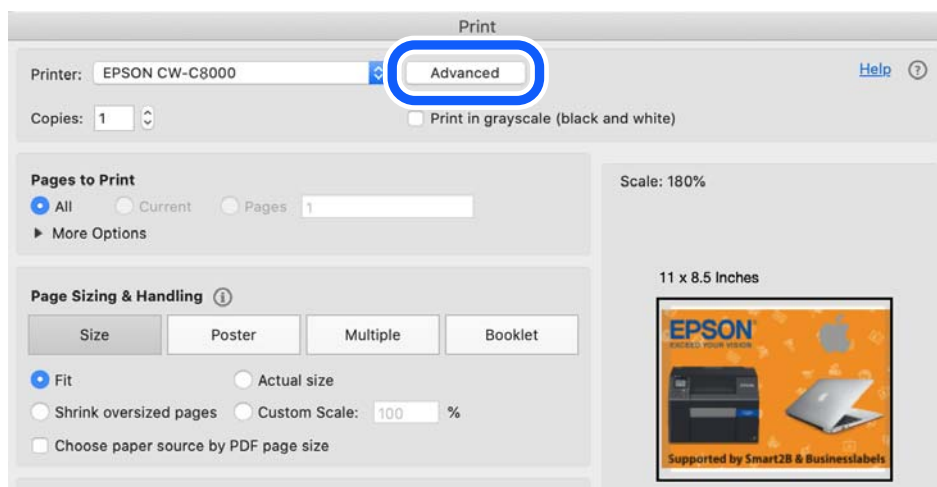

- 5 Select the checkbox for [Print As Image], and then click [OK].

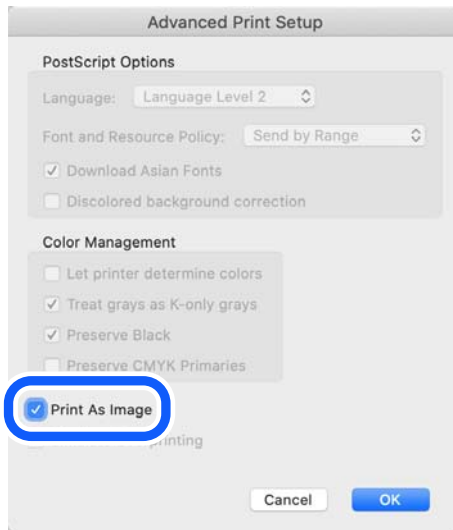

- 6 On the [Print] screen, click the [Print] button.

ICC Profile

What is ICC Profile?

An ICC profile is a file (file extension is .icc) that describes information for controlling colors according to the International Color Consortium (ICC) definition. Printout colors change significantly depending on the paper type and print mode.

CW-C8000 Series offer you the ICC profiles for each Epson genuine paper covering all combinations of paper types, print speed, and ink type. The ICC profiles are stored in the folder shown below when the Windows printer driver is installed.

C:\Windows\System32\spool\drivers\color

If you use paper other than Epson genuine paper, you need to prepare an ICC profile for the paper by yourself.

□ ICC Profiles provided for CW-C8000 Series

Media Name	Print speed	Ink Type	ICC Profile Name
Plain Paper	300 mm/s {11.81 in/s}	Gloss	CW-C8000Series_PlainPaper_300_BK.icc
		Matte	CW-C8000Series_PlainPaper_300_MK.icc
	150 mm/s {5.91 in/s}	Gloss	CW-C8000Series_PlainPaper_150_BK.icc
		Matte	CW-C8000Series_PlainPaper_150_MK.icc
Matte Paper	300 mm/s {11.81 in/s}	Gloss	CW-C8000Series_MattePaper_300_BK.icc
		Matte	CW-C8000Series_MattePaper_300_MK.icc
	150 mm/s {5.91 in/s}	Gloss	CW-C8000Series_MattePaper_150_BK.icc
		Matte	CW-C8000Series_MattePaper_150_MK.icc
Synthetic	300 mm/s {11.81 in/s}	Gloss	CW-C8000Series_Synthetic_300_BK.icc
		Matte	CW-C8000Series_Synthetic_300_MK.icc
	150 mm/s {5.91 in/s}	Gloss	CW-C8000Series_Synthetic_150_BK.icc
		Matte	CW-C8000Series_Synthetic_150_MK.icc
Texture Paper	300 mm/s {11.81 in/s}	Gloss	CW-C8000Series_TexturePaper_300_BK.icc
		Matte	CW-C8000Series_TexturePaper_300_MK.icc
	150 mm/s {5.91 in/s}	Gloss	CW-C8000Series_TexturePaper_150_BK.icc
		Matte	CW-C8000Series_TexturePaper_150_MK.icc
Glossy Paper	300 mm/s {11.81 in/s}	Gloss	CW-C8000Series_GlossyPaper_300_BK.icc
		Matte	CW-C8000Series_GlossyPaper_300_MK.icc
	150 mm/s {5.91 in/s}	Gloss	CW-C8000Series_GlossyPaper_150_BK.icc
		Matte	CW-C8000Series_GlossyPaper_150_MK.icc

Media Name	Print speed	Ink Type	ICC Profile Name
Glossy Film	300 mm/s {11.81 in/s}	Gloss	CW-C8000Series_GlossyFilm_300_BK.icc
		Matte	CW-C8000Series_GlossyFilm_300_MK.icc
	150 mm/s {5.91 in/s}	Gloss	CW-C8000Series_GlossyFilm_150_BK.icc
		Matte	CW-C8000Series_GlossyFilm_150_MK.icc
High Glossy Paper	300 mm/s {11.81 in/s}	Gloss	CW-C8000Series_HighGlossyPaper_300_BK.icc
		Matte	CW-C8000Series_HighGlossyPaper_300_MK.icc
	150 mm/s {5.91 in/s}	Gloss	CW-C8000Series_HighGlossyPaper_150_BK.icc
		Matte	CW-C8000Series_HighGlossyPaper_150_MK.icc



Some ICC profiles are created by X-Rite Solutions.

Procedure for Creating an ICC Profile

When using paper other than Epson genuine paper, acquire an ICC profile of the paper provided by the paper manufacturer, or create an ICC profile for the paper by yourself.

To create an ICC profile, you need a colorimeter and a software program that generates an ICC profile.

Example:

- X-Rite, Incorporated (<https://xritephoto.com/>)
 - i1iO2 (colorimeter), i1Profiler (software program to generate an ICC profile)
- Datacolor company (<https://www.datacolor.com/>)
 - SpyderPrint (print calibration tool)

Since detailed procedure varies depending on the device and software used, the following describes the general procedure. See the manual that came with the device and software for more details.

- 1 Start a software program that generates an ICC profile, and then print color patches for measurement on the paper you want to use.**
- 2 Measure the printed color patches with a colorimeter.**
- 3 Using the software program, generate an ICC profile according to the measured results.**



- Create a profile that is compatible with ICC version 2.
 - Use ASCII character strings for ICC profile names.
- For more details, visit the following URL.
<https://color.org>

Using Application's Color Correction Engine

No Color Adjustment

The [Color Correction] button is disabled when [Color Correction Mode] is set to [No Color Adjustment]. Select [No Color Adjustment] if you want to perform color correction in the application software you use. For instructions on how to set color correction on the software, see its manual or help.

Printing from the First Label

When [Media Detect] is set to [Gap] or [Hole], the first label cannot be printed at the first printing after paper loading.

However, even if [Media Detect] is set to [Gap] or [Hole], the following procedure will enable printing from the first label.



- When you perform the following and print, auto cut is disabled.
- If there is a difference between a label actually used and the settings on the printer driver, the print quality may decline.



This procedure is not necessary when [Media Detect] is set to [Black Mark] or [Off].

- 1 Cut off the backing paper from 2 mm {0.08 in.} away from the top edge of the first label.**

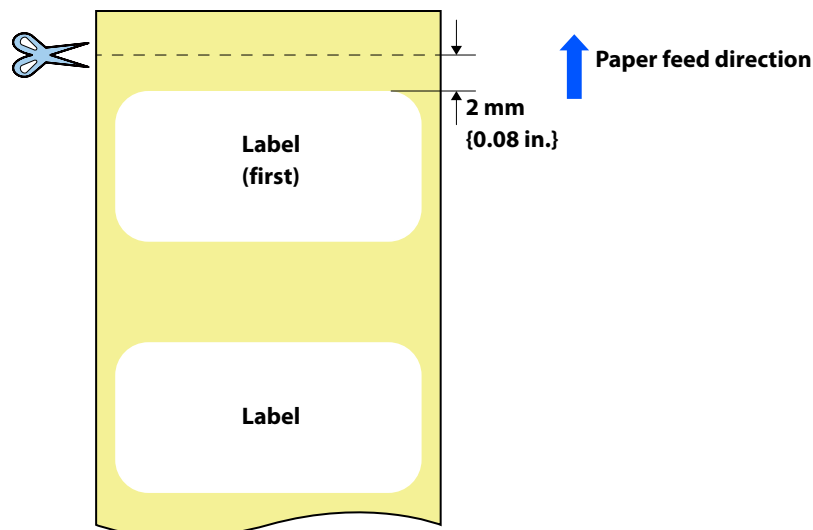

- 2 On the operation panel of the printer, select [Not Feed] from [Actions when Replacing Media].**
[Menu] - [General Settings] - [Printer Settings] - [Print Options] - [Actions when Replacing Media] - [Not Feed]
The default setting is [Feed].
- 3 Specify a length of the label, and a gap between labels.**
(["Media Settings" on page 65](#))
- 4 Load paper, and then print.**
For the paper loading procedure, see ["Loading Paper" on page 66](#).

Setting Label Size and Paper Layout for Borderless Printing

This section describes the concepts and settings methods for borderless printing using the Epson printer driver.



- Setting the left and right gaps to less than 2 mm {0.08 in.} may cause ink stains on labels or hands.
- Adding a margin of 1.5 mm {0.06 in.} or more at the top edge of the print area may reduce the ink stains.

Borderless Printing Concepts

Borderless printing can be achieved by adjusting the left and right gap settings of the printer driver to align the print start position with the left edge of the label.

Use label paper that has waste parts (the adhesive paper around each label that is discarded) to prevent the release liner (backing paper) from being smudged with ink.



Adjust Left and Right

- Label
- Waste part
- Release liner

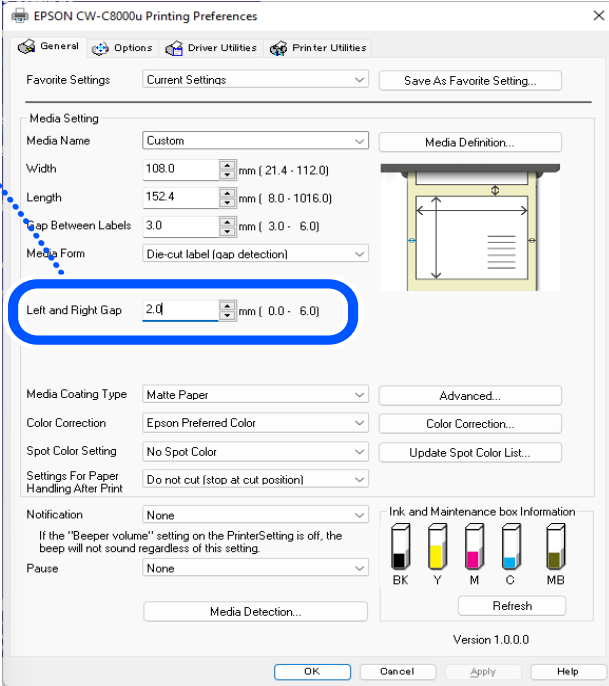

EPSON CW-C8000u Printing Preferences

Media Setting

Media Name: Custom

Width: 108.0 mm (21.4 - 112.0)

Length: 152.4 mm (8.0 - 1016.0)

Gap Between Labels: 3.0 mm (3.0 - 6.0)

Media Form: Die-cut label (gap detection)

Left and Right Gap: 2.0 mm (0.0 - 6.0)

Media Coating Type: Matte Paper

Color Correction: Epson Preferred Color

Spot Color Setting: No Spot Color

Settings For Paper Handling After Print: Do not cut (stop at cut position)

Notification: None

Pause: None

Ink and Maintenance box Information: BK Y M C MB

Version 1.0.0.0



- Using die-cut label paper that do not have waste parts around each label may cause ink to adhere to the label, your hands, or the inside of the printer, resulting in stains.

Label Paper Settings

- When using die-cut labels, use kiss cut die-cut label paper that has waste parts around each label. However, there should be no waste parts at both side edges of roll paper.
- The Windows printer driver and PrinterSetting perform the following input value checks and automatic corrections.
 - The input value check checks that ("Left and Right Gap" x 2) + "Width" does not exceed the width of the paper. If the value being entered causes the maximum (minimum) paper width to be exceeded, the upper (lower) limit of the input value is limited and adjusted so that the maximum (minimum) paper width is not exceeded.
- Since input value checks and automatic correction are not performed except for the Windows printer driver and PrinterSetting, if paper layout settings such as left-right gap and label width are set from other software and the settings exceed the printing range, only the printable range will be printed.

Adjusting Head-Media Clearance Height

The printer allows you to adjust the gap between the print head and paper (Head-Media Clearance Height). This adjustment enables printing on thicker paper, such as tags, and paper thinner than normal labels and continuous paper without degrading print quality. This function can be set on the printer's operation panel or in PrinterSetting.

Set [Head-Media Clearance Height] based on the following paper thicknesses.

Setting	Approximate paper thickness	Description
1	0.11 mm {0.004 in.}	High Glossy continuous paper
2	0.24 mm {0.009 in.} or less	Normal labels, Continuous paper
3	0.32 mm {0.013 in.} or less	Tag without RFID
4	0.59 mm {0.023 in.} or less	Tag with RFID



The factory default setting is "2". Change the setting in the following cases.

- If printing is blurred or double, lower the setting value.
- If the print head and paper rub against each other and the paper becomes dirty, increase the setting value.

Adjusting Detectors Sensitivity and Label Detection Thresholds

The printer is equipped with two detectors; one detects leading edge of each label and another one detects black marks.

If you have labels that cannot be detected by the printer, the labels may become detectable by changing sensitivity of the detectors and/or threshold for detecting labels.

Change the settings using the operation panel.

[Menu] - [Maintenance] - [Calibration]

Simple Media Detect

Allows you to adjust the threshold for detecting labels. Since this adjustment can be made in a short time, perform this adjustment first.

Media Detect

Allows you to adjust the sensitivity of the detectors and the threshold for detecting labels. Perform this adjustment if your labels still cannot be detected after performing the [Simple Media Detect] adjustment.



When using fanfold paper, flatten the perforations on the first through third sheets before loading the paper. Failure to flatten the perforations may result in incorrect adjustment.

Adjusting the Gap Detector

When printing on tags or odd-shaped labels such as circle or oval labels, adjust the gap detectors as described below.



When using common labels such as square die-cut labels or full-page labels, the gap detector position does not need to be changed from its initial position.

1 Remove paper from the printer.

"Removing Paper" on page 81

2 Turn off the printer.

3 Adjust the detectors by operating the two adjustment tabs.

Push and move the adjustment tab horizontally using a fine-tipped tool such as a pen.

The tab can be moved in increments of 1 mm {0.04 in.} within the range of 3 to 56 mm {0.12 to 2.20 in.} from the paper edge.

Align the triangular tip of the adjustment tab with the scale.

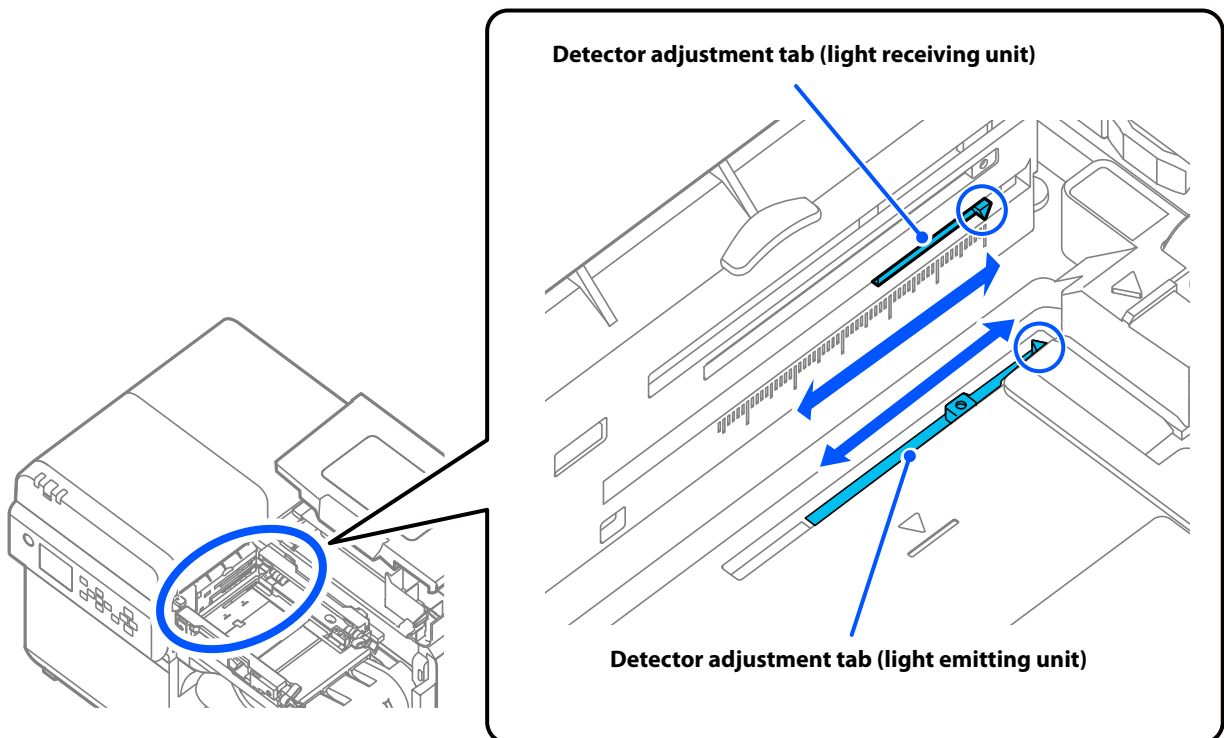

CAUTION

- Make sure to adjust the detectors before printing on odd-shaped labels.
- Make sure to turn off the printer to adjust the detectors. If you adjust the detectors with the printer powered on, the detector may malfunction resulting in starting auto paper feeding.
- Make sure to align the triangular tips of the two adjustment tabs to the same position. If the two triangular tips are misaligned, printing will become impossible causing a paper detection error.

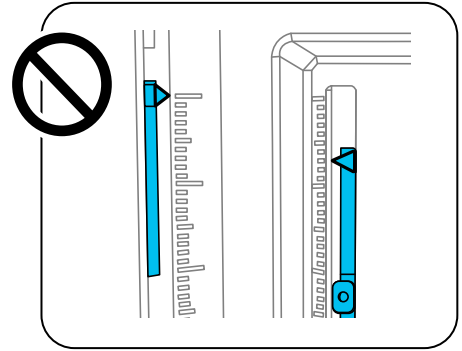
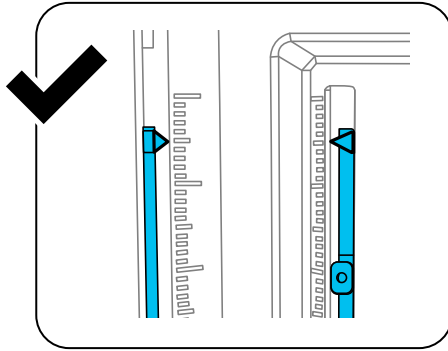

Gap Detector Adjustment Examples

For circular die-cut labels

Align the triangular tips of the adjustment tabs on both the light-receiving and light-emitting sides with the center of the circle (dashed line).

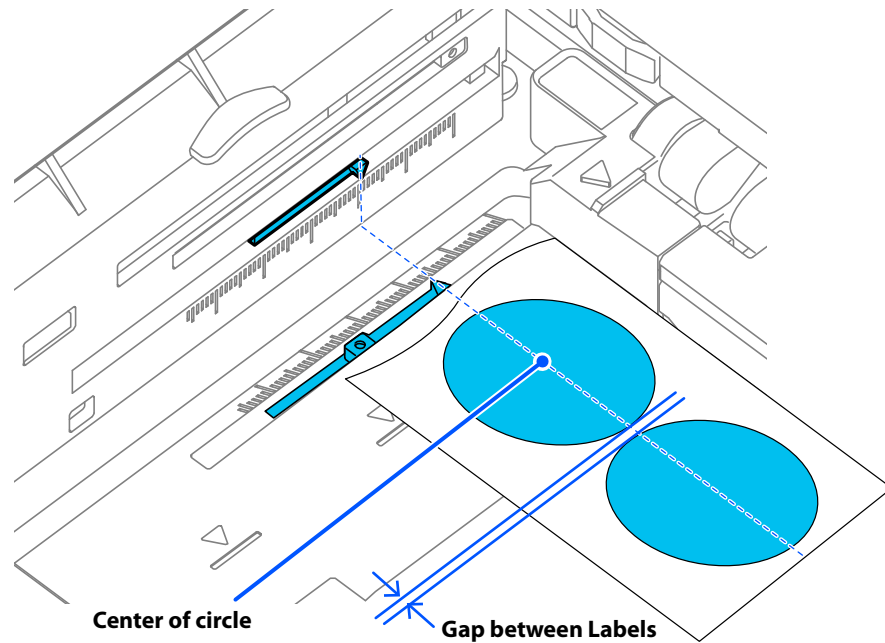

For tags (with hole, oblong hole, cutout)

Tag (hole detection)

Align the triangular tips of the adjustment tabs on both the light-receiving and light-emitting sides with the center of the hole (dashed line).

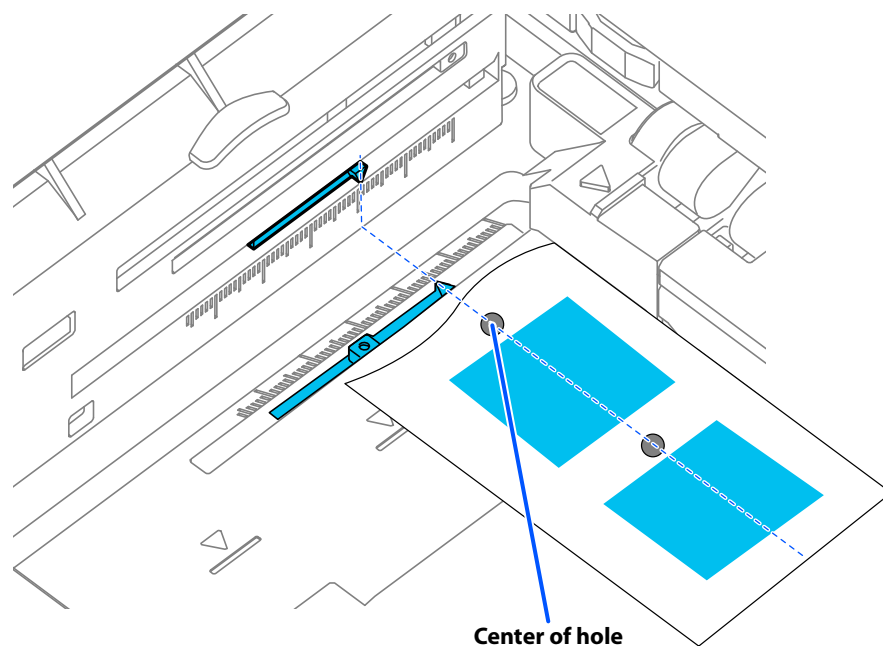

Tag (oblong hole detection)

Align the triangular tips of the adjustment tabs on both the light-receiving and light-emitting sides with the center of the oblong hole (dashed line).

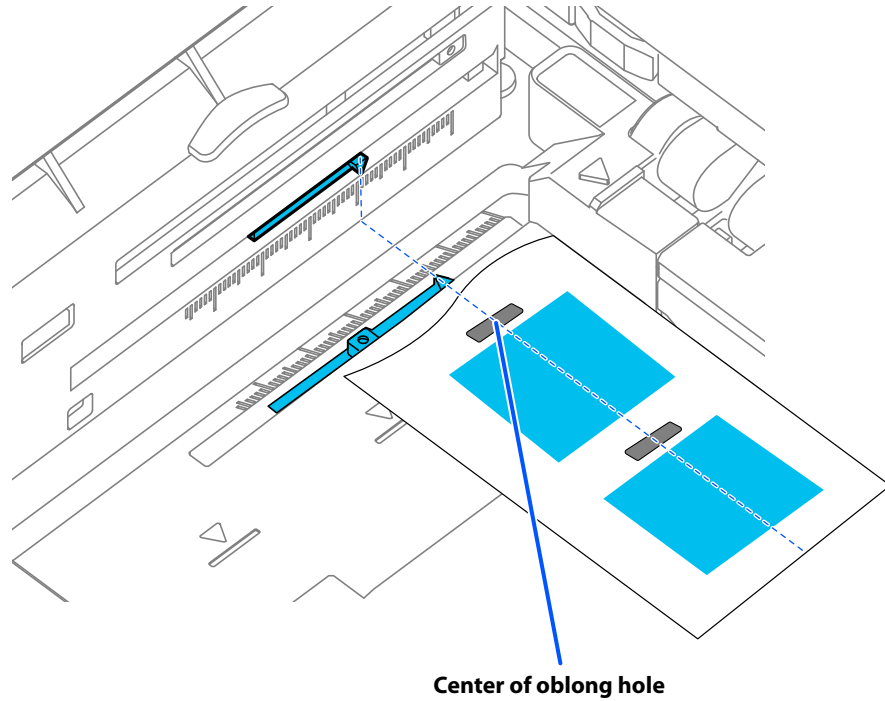
**Tag (cutout detection)**

Align the triangular tips of the adjustment tabs on both the light-receiving and light-emitting sides with the center of the cutout (dashed line) at the fixed edge guide side.

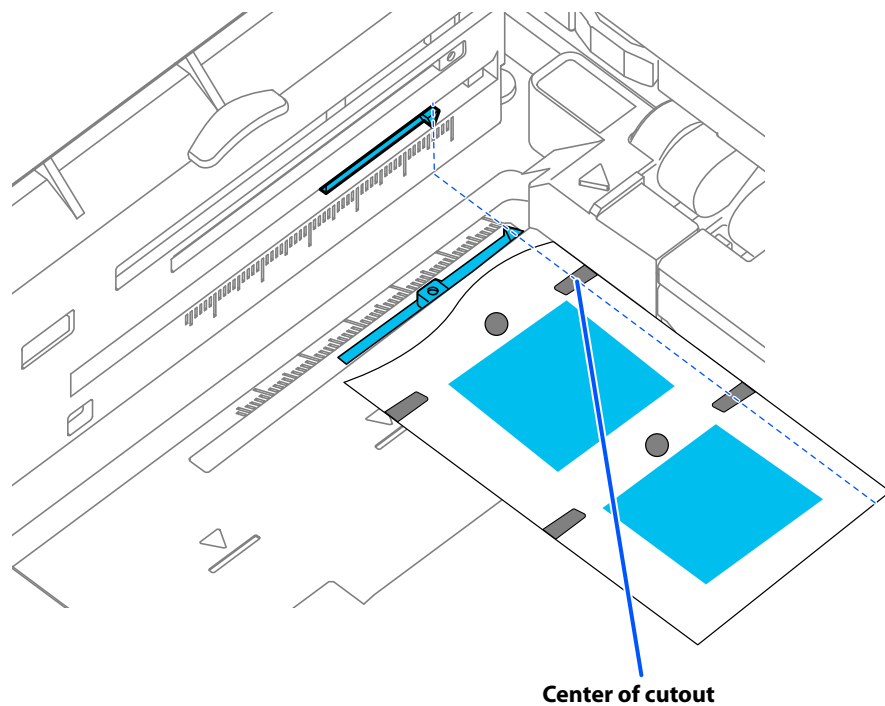



Storing the Printer After Ink is Charged

Storing the Printer for Long Periods



If you need to store the printer for long periods after installing the ink packs, follow the procedure below.

- 1 Run the nozzle check to confirm that the print head nozzles are not clogging and there is no problem with the print quality. If the print quality is not good, run a print head cleaning.

See "Test Print" on page 79.



 CAUTION	<p>If you store the printer without solving the print quality problem (nozzle clogging), ink inside the nozzles may get hard and the print quality problem may become unrecoverable when you start using the printer again.</p>
	<p>If you have transported the printer after installing the ink packs, nozzle clogging may occur due to vibrations applied to the printer during the transport.</p>

- 2 When printing is finished, press the  (power) button to turn off the printer.

 CAUTION	<p>Especially when storing the printer for long periods, make sure to turn it off using the  (Power) button.</p>
---	---

- 3 Store the printer in a cool and dark place.

For information about environmental requirements for storing the printer, see "[Environmental Specifications](#)" on page 393.

 CAUTION	<p>The printer has a storage life of up to six months.</p>
	<p>Make sure to store the printer with all ink packs installed.</p>

Transporting or Storing the Printer at -10°C (14°F) (With Matte Black Ink Installed)

If the ambient temperature becomes -10°C (14°F) or lower, the print head may be damaged. If -10°C (14°F) or lower ambient temperature is expected, discharge ink in advance following the procedure below.



- Since ink is discharged to the maintenance box, the box needs to have enough remaining space for the discharged ink. If the remaining space in the box is not enough, have a new maintenance box ready for replacement.
- During the ink discharging work, keep the ambient temperature between 5 to 35°C (41 to 95°F).
- While the printer is discharging ink, do not open any cover or turn off the printer.

- 1 If paper has been loaded, remove it.**
- 2 Select the menus on the operation panel in the order shown below.**
[Menu] - [Maintenance] - [Ink Discharging]
- 3 When a confirmation message is displayed, select [Start].**
Ink discharging is started. When discharging ink is finished, the printer is automatically turned off.



When you use the printer next time, you need to recharge ink to the printer. When the printer is turned on, a confirmation screen for recharging ink appears. Select [OK] to start recharging ink. It takes about 9 minutes. When recharging ink is finished, a home screen appears.

For Using the Printer after Long Storage

When using the printer after storing it for long periods, follow the procedure below.

- 1 Check that the ink packs have not expired.**



Replace the ink packs with new ones in the following cases.
For instructions on how to replace the ink packs, see ["Replacing the Ink Packs" on page 84](#).

- Three years or more have passed from the manufacturing date.
- One year or more have passed from when the ink packs were installed in the printer.

- 2 Turn the printer on.**
The auto self-check function checks the nozzles for clogging and run a cleaning.



CAUTION

While the printer is running the print head cleaning, do not turn off the power or open the paper cover, top cover, or the ink cover.

- 3 Run the nozzle check to confirm that the print head nozzles are not clogging and there is no problem with the print quality.**

For Transporting the Printer

When transporting the printer, make sure to follow the guidelines below.



- Make sure to remove paper before transporting the printer.
- Do not remove the ink packs and the maintenance box for transporting the printer.
- When turning off the printer for transporting, make sure to turn off the printer with the  (Power) button.
- Do not let the printer tilt to all directions by 10 degrees or more during transportation. Otherwise, the printer may fall down causing an accident.
- Do not let the printer upside down or lay on its side during transportation.

Cleaning the Printer

This chapter describes how to carry out maintenance of the printer.

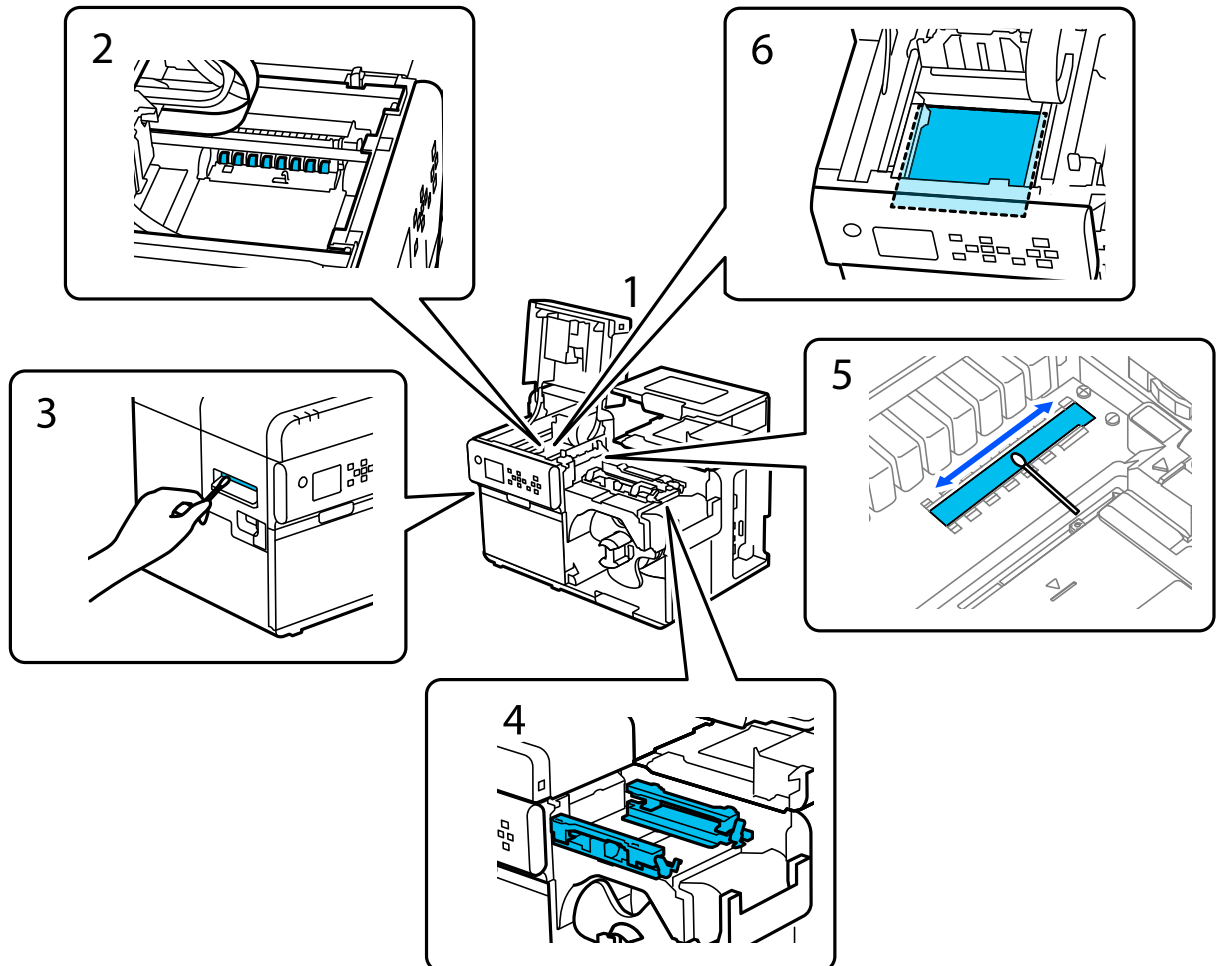

1	"Cleaning the Exterior" on page 302
2	"Cleaning the Paper Pressure Roller" on page 305
3	"Cleaning the Auto Cutter" on page 302
4	"Cleaning the Edge Guides" on page 303
5	"Cleaning the Gap Detector (Light Emitting Unit)" on page 307
6	"Cleaning the Platen" on page 308

Cleaning the Exterior

Turn off the printer, and then wipe off any dirt with a dry cloth or non-woven fabric that has been dampened. Make sure to unplug the printer when cleaning it.



Do not use alcohol, benzene, thinner, trichloroethylene, or ketone based solvent for cleaning. Doing so may deform or damage the plastic and rubber parts.

Cleaning the Auto Cutter



Watching the Video on How to Clean the Printer

https://support.epson.net/p_doc/95e/

📄 "Cleaning the Printer (CW-C8000 Series)"

If labels, paper dust, or adhesive has adhered to the fixed blade of the auto cutter, the blade may become dull. Clean the fixed blade following the procedure below.

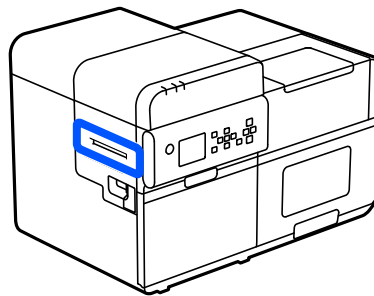

- 1** If paper has been loaded, remove it.
📄 "Removing Paper" on page 81
- 2** Turn the printer off and then disconnect the power cable from the outlet.
- 3** Using an alcohol-soaked cotton swab, remove labels, paper dust, and adhesive materials adhering to the fixed blade of the auto cutter from both ends toward the center, as shown in the figure below.

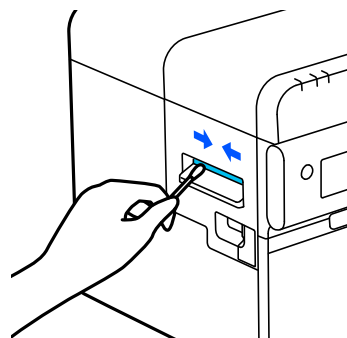

Cleaning the Edge Guides



Watching the Video on How to Clean the Printer

https://support.epson.net/p_doc/95e/

📄 "Cleaning the Printer (CW-C8000 Series)"



Viewing How to Clean the Edge Guides on the Operation Panel

? (Help) – [How To...] – [Clean the Edge Guide]

Labels, paper dust, or sticky materials on the edge guides may degrade print quality.

Clean the edge guides following the procedure below.

1 If paper has been loaded, remove it.

📄 "Removing Paper" on page 81

2 Open the paper cover.

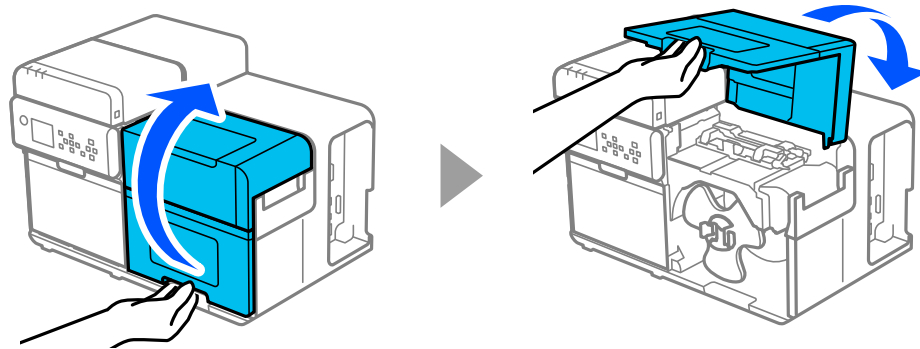

3 Raise the paper holds.

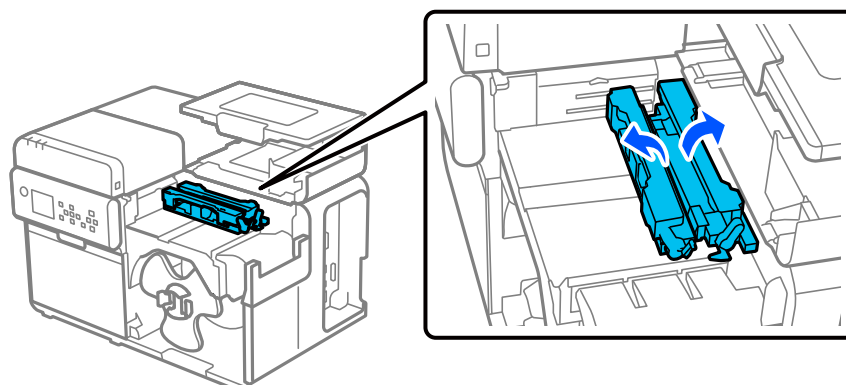

- 4** While pressing the blue lever, slide the movable edge guide toward you until it stops.

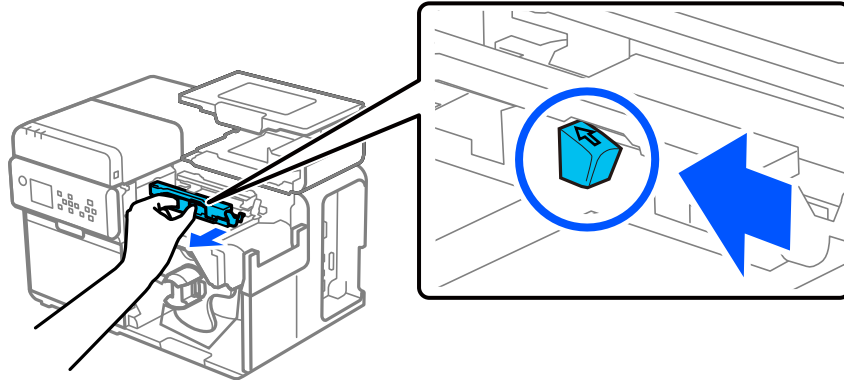

- 5** Remove labels, paper dust, and adhesive materials from the edge guides with a soft cloth dampened with water and wrung tightly.

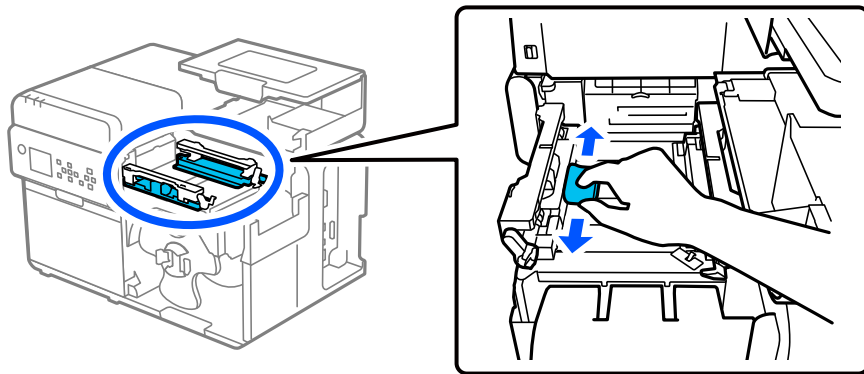

CAUTION

Do not use alcohol, benzine, thinner, trichloroethylene, or ketone based solvent for cleaning. Doing so may deform or damage the plastic and rubber parts.

Cleaning the Paper Pressure Roller



Watching the Video on How to Clean the Printer

https://support.epson.net/p_doc/95e/

📄 "Cleaning the Printer (CW-C8000 Series)"

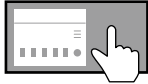

Viewing How to Clean the Paper Pressure Rollers on the Operation Panel

? (Help) – [How To...] – [Clean the Paper Pressure Roller]

Labels, paper dust, or sticky material on the paper pressure rollers may cause paper jams or blurred printing results.

Clean the paper pressure rollers following the procedure below.

- 1** If paper has been loaded, remove it.
📄 "Removing Paper" on page 81
- 2** Push the lever backward and open the top cover.

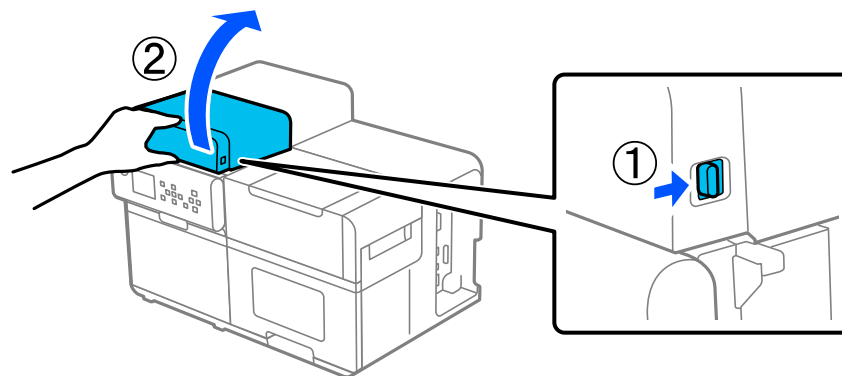

3 Remove labels, paper dust, and adhesive materials from the paper pressure rollers using an alcohol-soaked cotton swab.

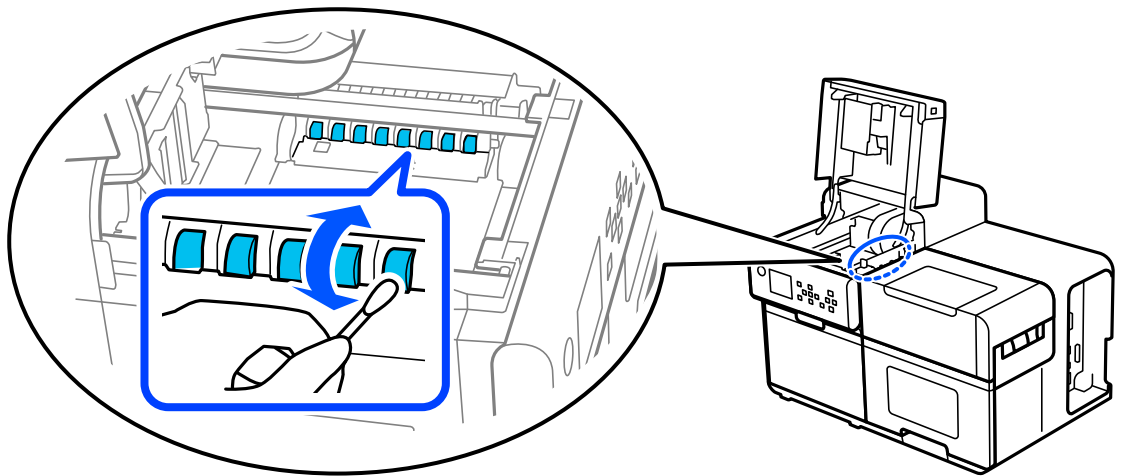
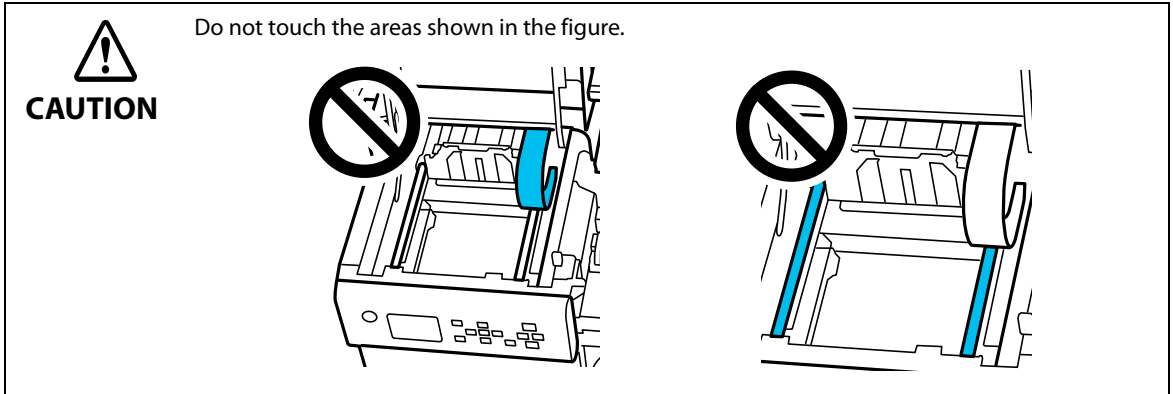

Cleaning the Gap Detector (Light Emitting Unit)

If ink, paper dust, or adhesive materials adhere to the transparent plate on the light-emitting side of the gap detector, the following problems may occur.

- Loaded paper is not fed
- Paper is ejected and an error occurs because the gap is not detected

Follow the steps below to clean the detector.

- 1** If paper has been loaded, remove it.
 "Removing Paper" on page 81
- 2** Turn the printer off and then disconnect the power cable from the outlet.
- 3** Push the lever backward and open the top cover.

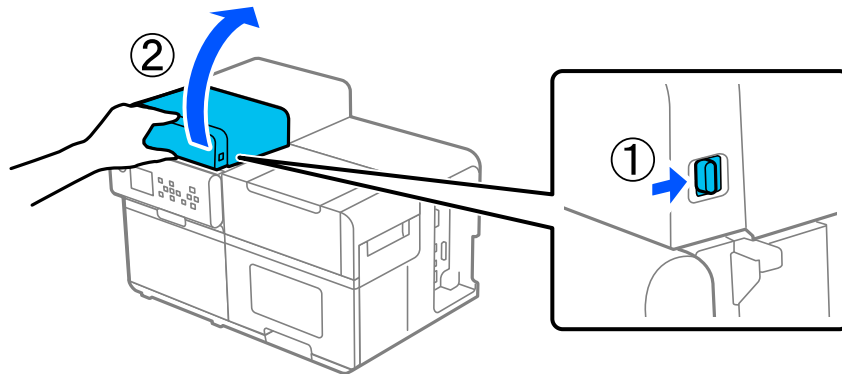

- 4** Raise the paper insertion slot cover and remove any ink, paper dust, or sticky material adhering to the transparent plate of the gap detector (light emitting side) with a cotton swab moistened with water.

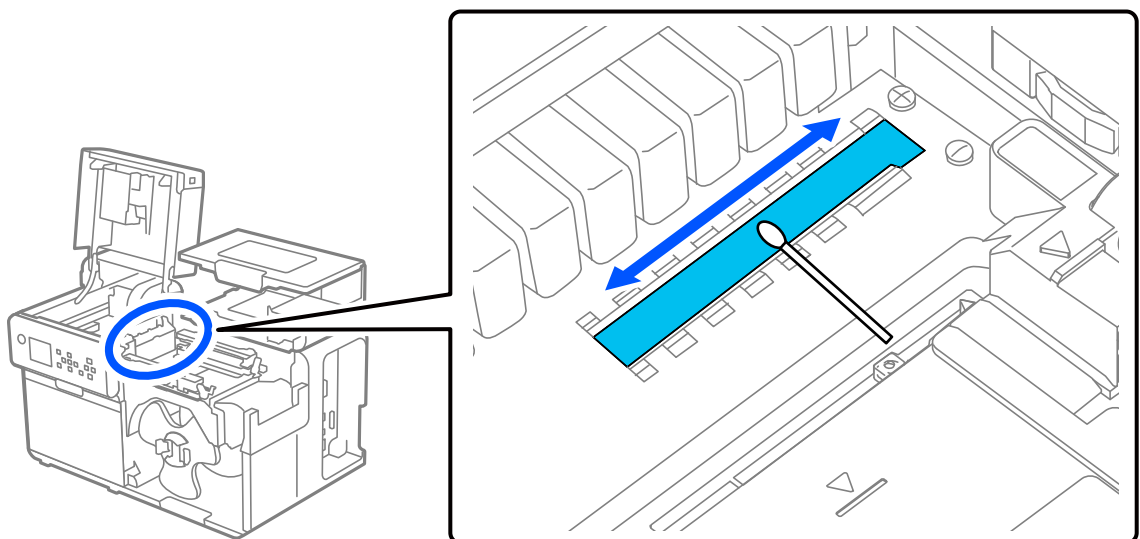

- Make sure the paper path is not wet after cleaning.
- Do not use alcohol, benzene, thinner, trichloroethylene, or ketone based solvent for cleaning. Doing so may deform or damage the plastic and rubber parts.

Cleaning the Platen



Watching the Video on How to Clean the Printer

https://support.epson.net/p_doc/95e/

📄 "Cleaning the Printer (CW-C8000 Series)"

If labels, paper dust, or adhesive has adhered to the platen, paper may get jammed, or printing position may become incorrect.

Clean the platen following the procedure below.

- 1** Check that the printer has been turned off.
- 2** If paper has been loaded, remove it.
📄 "Removing Paper" on page 81
- 3** Push the lever backward and open the top cover.

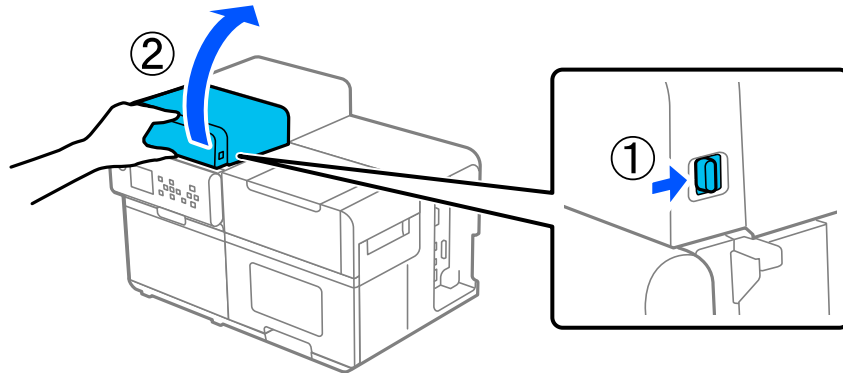

- 4** Remove labels, paper dust, and sticky materials from the platen with a soft cloth dampened with water and wrung out tightly, or a cotton swab.



CAUTION

Be careful not to leave cloth or cotton swab fibers on the platen when removing stains.

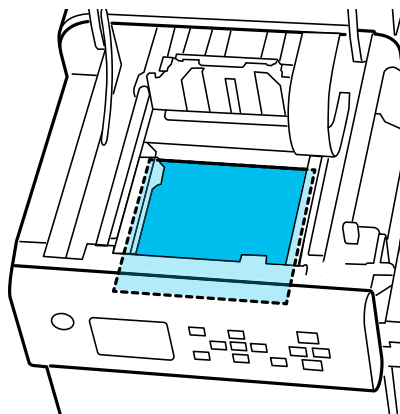

- 5** Close the top cover.

Print Head Cleaning

If the nozzles are clogged, faint colors, banding, or unintended colors appear on printouts.

When such print quality problems occur, print nozzle check patterns to check for clogged nozzles.

When the printed patterns indicate that the nozzles are clogged, run a head cleaning.

Example of the nozzle check patterns with gloss black ink

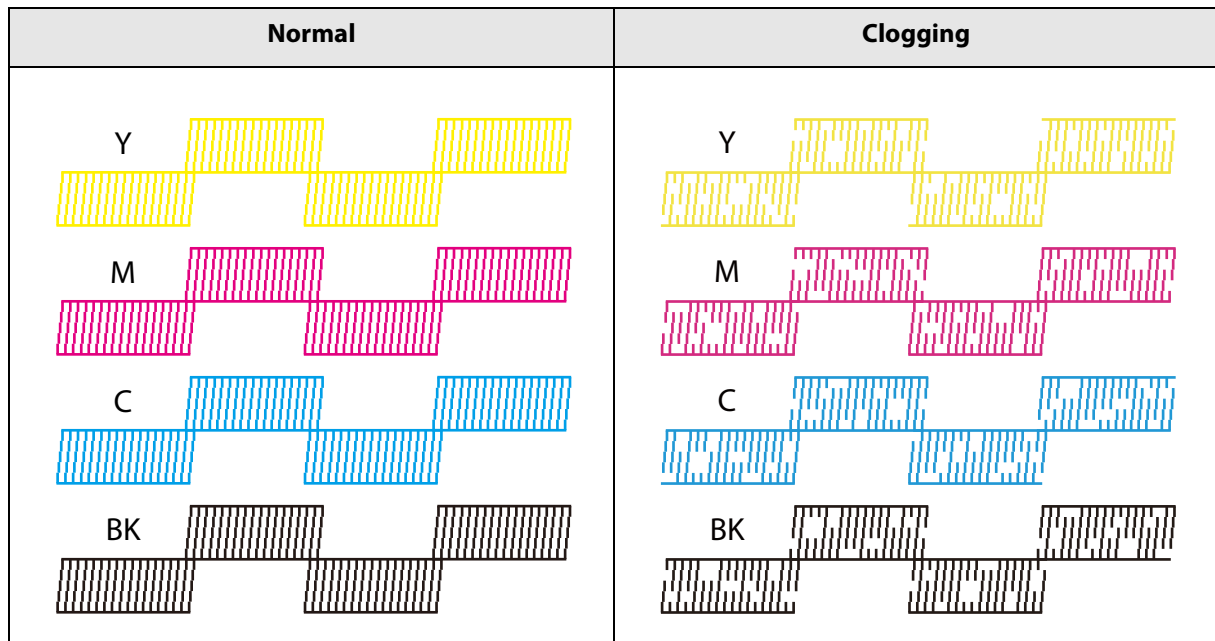

Printing Nozzle Check Patterns

If the nozzles are clogged, faint colors, banding, or unintended colors appear on printouts.

When such print quality problems occur, print nozzle check patterns to check for clogged nozzles.



The nozzle check pattern is printed to fit the paper width set on the printer's operation panel. However, if the printer detects that the actual paper width is narrower than the set paper width, the nozzle check pattern is printed to fit the actual paper width.

Media Forms that Can be Used for Nozzle Check Pattern Printing

- Continuous paper
- Full-page label
- Die-cut label with a length of approximately 112 mm {4.41 in.} or more^{*1}
- Tag^{*2}

*1: If the die-cut label is less than approximately 112 mm {4.41 in.} long, some portions of the nozzle check pattern will be printed onto the backing paper.

*2: Since the pattern cannot be printed avoiding the holes in the tag, part of the pattern may be printed on the platen through the holes.

Printing using the Operation Panel

[Menu] - [Maintenance] - [Print Head Nozzle Check]

Printing using the Printer Driver

Click [Nozzle Check] on the Printer Utilities tab.

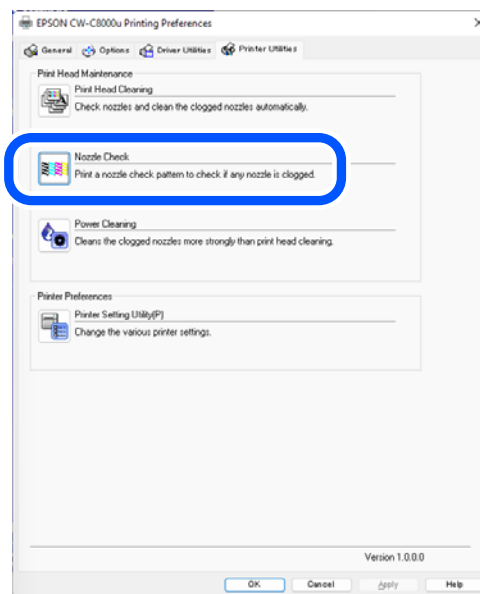

Printing using the Web Config

Select [Print Nozzle Check Pattern] on the [Maintenance] window, and then click [Start].

For details on Web Config, see ["Web Config" on page 240](#).

Running Print Head Cleaning

If nozzles are clogged, run [Print Head Cleaning]. Run [Power Cleaning] only when nozzle clog is not cleared by running [Print Head Cleaning].

To run a print head cleaning, select the menu as described below.

IMPORTANT

- Do not turn off the power or open the covers during head cleaning. Doing so may cause printing malfunction.
- Do not run the head cleaning more than necessary. Ink is consumed because ink is discharged from the head to clean it.
- If there is not much ink remaining, head cleaning may not be possible. Replace the ink packs and then try again.
["Replacing the Ink Packs" on page 84](#)
- The [Power Cleaning] consumes ink more than [Print Head Cleaning].

Running using the Operation Panel

[Menu] - [Maintenance] - [Print Head Cleaning]

[Menu] - [Maintenance] - [Power Cleaning]

Running using the Printer Driver

Click [Print Head Cleaning] or [Power Cleaning] on the [Printer Utilities] window.

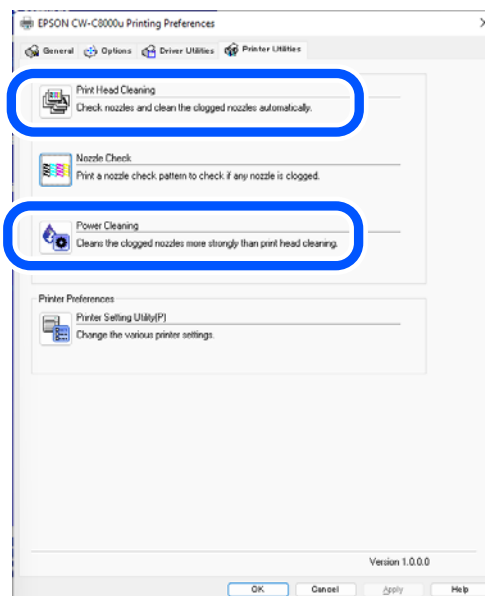











Running using the Web Config

Select [Print Head Cleaning] on the [Maintenance] window. Then select the cleaning type from [Auto] or [Power Cleaning], and then click [Start].

For details on Web Config, see ["Web Config" on page 240](#).





Troubleshooting

A Message Appears on the Operation Panel

Message	Solution and Reference
Information Paper feed error. Load the paper or change the media source setting.	Use paper that matches the [Media Source] and [Media Form] settings. Or change the [Media Source] and [Media Form] settings to match them with the loaded paper.  "Media (Paper) Settings" on page 93
Information Cannot detect the paper specified by the Media Detect setting. Load paper that matches the setting or change the setting.	Use paper that matches the [Media Detect] settings. Or change the [Media Detect] settings to match them with the loaded paper.  "Media (Paper) Settings" on page 93
(On the home screen) Load paper.	Load paper.  "Loading Paper" on page 66
Information The media size loaded does not match the size set in the media layout settings. Check the instructions to replace the media or cancel printing to change the media layout settings.	Load media that matches the print area size. Or change the print area to match it with the media size.  "Loading Paper" on page 66
Information Failed to detect labels. Reload the paper following the operating instructions, or restart printing.	Remove the paper, and then load the paper again.  "Removing Paper" on page 81  "Loading Paper" on page 66
No paper The roll paper is not loaded.	Load roll paper.  "Loading Paper" on page 66
No paper The fanfold paper is not loaded.	Load fanfold paper.  "Loading Paper" on page 66
Information Paper jam.	Remove the jammed paper and then load paper.  "Roll Paper is Jammed" on page 335  "Fanfold Paper is Jammed" on page 340











Message	Solution and Reference
<p>Information</p> <p>The paper is not loaded correctly.</p> <p>Remove the paper from the paper guide unit, close the paper cover, and then press the "Pause" button.</p>	<p>Remove the paper, and then load the paper again.</p> <p>🔗 "Removing Paper" on page 81</p> <p>🔗 "Loading Paper" on page 66</p> <p>Depending on the condition of the end of the roll paper, this error may occur because the printer cannot detect that the paper has run out. Check the condition of the end of the roll.</p> <p>🔗 "Paper Specifications" on page 370</p> <p>Make sure that the light-receiving detector adjustment tab and the light-emitting detector adjustment tab are in the same position.</p> <p>How to align the gap detectors:</p> <p>🔗 "Adjusting the Gap Detector" on page 294</p> <p>If this does not resolve the problem, calibrate the detector.</p> <p>How to calibrate the detector:</p> <p>🔗 "Adjusting Detectors Sensitivity and Label Detection Thresholds" on page 293</p>
<p>Information</p> <p>Pattern 1</p> <p>Calibration failed.</p> <p>Confirm the setting and try again.</p> <p>Pattern 2</p> <p>Calibration failed.</p> <p>Press the "Dismiss" button.</p> <p>Then reload or replace the paper.</p>	<p>Make sure that the paper loaded in the printer matches the paper detection method, and reset the paper.</p> <p>🔗 "Loading Paper" on page 66</p> <p>Calibration is impossible if gap between labels exceeds 6 mm {0.24 in.}.</p> <p>🔗 "Paper Specifications" on page 370</p> <p>If the error still occurs, the detector cannot handle the paper. Replace the paper.</p>
<p>Information</p> <p>The paper has already been cut and cannot be cut.</p>	<p>This error occurs when you press the Cut button at the position where the paper is already cut.</p> <p>Feed the paper by printing or pressing the Feed button to enable the Cut button.</p>
<p>Maintenance Error</p> <p>The ink pack is not installed correctly.</p>	<p>Install an ink pack with a sufficient amount of ink remaining.</p> <p>🔗 "Replacing the Ink Packs" on page 84</p>
<p>(On the home screen, an exclamation mark on the ink levels)</p>	<p>It is almost time to replace the ink pack. Prepare a new ink pack for replacement.</p> <p>If you continue to use the ink pack that is low on ink, you may be required to replace it during printing.</p> <p>🔗 "Replacing the Ink Packs" on page 84</p> <p>The removed ink pack can be installed again and used until you are prompted to replace it.</p>
<p>Ink levels are not enough for Initialization.</p>	<p>Install ink pack(s) with sufficient ink remaining.</p> <p>🔗 "How to Replace the Ink Packs" on page 84</p>
<p>Information</p> <p>You need to replace the following ink pack(s).</p>	<p>Install an ink pack with a sufficient amount of ink remaining.</p> <p>🔗 "Replacing the Ink Packs" on page 84</p>

Message	Solution and Reference
<p>Maintenance Error Cannot recognize the ink pack. Select "Next" to clear the error.</p>	<p>Reinstall the ink pack. If the error reoccurs, replace the ink pack with a new one. 🔗 "Replacing the Ink Packs" on page 84</p>
<p>Information You have not installed genuine Epson ink packs.</p>	<p>For the best performance of the printer, it is recommended to use genuine Epson ink packs. Use of non-genuine Epson ink packs can adversely affect the printer and print quality and prevent the printer from realizing its maximum performance. Epson cannot guarantee the quality and reliability of non-genuine Epson products. Repairs for any damage or breakdown of this product due to the use of non-genuine Epson products will not be free of charge even if the warranty period is still valid.</p>
<p>Information The ink packs are not compatible.</p>	<p>Because the installed ink packs are not the ones for this printer, an error such as a ink pack detection error may occur.</p>
<p>Maintenance Error Maintenance Box not installed. Product Number: SJMB7500</p>	<p>Install a new maintenance box. 🔗 "Replacing the Maintenance Box" on page 88</p>
<p>Maintenance Error Cannot recognize the Maintenance Box. Product Number: SJMB7500</p>	<p>Reinstall the maintenance box. If the error reoccurs, replace the maintenance box with a new one. 🔗 "Replacing the Maintenance Box" on page 88</p>
<p>(On the home screen) The Maintenance Box is nearing end of its service life.</p>	<p>It is almost time to replace the maintenance box. Prepare a new maintenance box for replacement. When a message saying "The Maintenance Box is at the end of its service life. You need to replace it." is displayed, replace the maintenance box. 🔗 "Replacing the Maintenance Box" on page 88</p>
<p>Maintenance Error The Maintenance Box is at the end of its service life. You need to replace it. Product Number: SJMB7500</p>	<p>Replace the maintenance box with a new one. 🔗 "Replacing the Maintenance Box" on page 88</p>
<p>Information Memory Full. Document was not printed.</p>	<p>Contact your system administrator and delete unnecessary files.</p>
<p>Printer Error Turn on the printer again. See your documentation for more details. XXXXXX</p>	<p>1. Turn off the printer. 2. Check that there is no paper jam or foreign materials near the ejection slot. 3. Turn the printer on. If the printer error still occurs, contact qualified service personnel for advice. When contacting, tell the person the "XXXXXXX" (a 6- or 8-digit alphanumeric code).</p>





Message	Solution and Reference
<p>Information</p> <p>Cannot start cleaning because ink is low. Printer features except cleaning are available.</p>	<p>When running the cleaning, install ink packs with a sufficient amount of ink remaining.</p> <p> "Replacing the Ink Packs" on page 84</p>
<p>Information</p> <p>Cannot start cleaning because the Maintenance Box is near full. Printer features except cleaning are available.</p>	<p>When performing cleaning, install a maintenance box with sufficient free space.</p> <p> "Replacing the Maintenance Box" on page 88</p>
<p>Information</p> <p>Paused</p> <p>The print quality may decrease because the nozzles are clogged.</p>	<p>The print quality may decrease because the nozzles are clogged. If it is not acceptable, run a print head cleaning.</p> <p> "Print Head Cleaning" on page 309</p>
<p>Information</p> <p>The print quality may decrease because the status of nozzles cannot be detected.</p>	<p>The automatic nozzle check function is disabled, which may result in poor print quality. Enable the setting if necessary.</p> <p> "Auto Nozzle Check System" on page 30</p> <p>The printer is also able to complement missing dots caused by clogged nozzles using adjacent nozzles if a total of 16 or fewer nozzles are clogged.</p> <p> "Complementary Printing (Dot substitution) Function" on page 33</p>
<p>Error Message</p> <p>Communication between the network and the printer is unstable.</p> <p>You may be able to resolve this by setting IEEE802.3az (Energy Efficient Ethernet) to "Off".</p> <p>See your documentation for details.</p>	<p>When connecting to a wired LAN using a device that supports IEEE802.3az (Energy Efficient Ethernet), the connection may be unstable, lost, or the communication speed may become slow.</p> <p>Follow the steps below to disable the IEEE802.3az function on your computer and printer.</p> <ol style="list-style-type: none"> 1. Disconnect the LAN cables from the computer and printer respectively. 2. If the IEEE802.3az function has been enabled on your computer, disable it. 3. Connect the computer and printer directly with a LAN cable. 4. On the printer, select [Menu] - [General Settings] - [Network Settings] - [Connection Check] to check the IP address of the printer. 5. Start Web Config on the computer. <p>Start your web browser and enter the IP address of the printer.</p> <ol style="list-style-type: none"> 6. Select the [Network Settings] tab, then [Ethernet]. 7. Set [IEEE 802.3az] to [Off]. 8. Click [Next]. 9. Click [Apply]. 10. Disconnect the LAN cable from the computer and printer. 11. If you disabled IEEE802.3az on your computer in step 2, enable it. 12. Connect the LAN cables you disconnected in step 1 to the computer and printer. <p>If the problem still occurs, a device other than the printer may be causing the problem.</p>





Message	Solution and Reference
(On the home screen) Maintenance Request: Replace Parts Soon XXXXXXXX	You will need to replace the parts. Contact qualified service personnel for advice. When contacting, tell the person the "XXXXXXXX" (a 6- or 8- digit alphanumeric code). This message cannot be cleared until the part is replaced. If the part reaches the end of its service life, printing is disabled.
Maintenance Request: End Of Parts Service Life Turn on the printer again. See your documentation for more details. XXXXXXXX	Printing is disabled until you replace the parts. Contact qualified service personnel for advice. When contacting, tell the person the "XXXXXXXX" (a 6- or 8-digit alphanumeric code).
The printer can't connect to cloud service. Please check the connection status and settings with the cloud service. Please contact your administrator for details.	The printer is failing to connect to the Software Cloud. Contact your system administrator for more information.

Print Quality Problems





Status	Cause	Solution and Reference
Vertical (Paper Width Direction) White Banding	The printed paper was fed backward.	<ul style="list-style-type: none"> If printed paper is fed backward, the paper is stepped on by the paper pressure rollers and print quality deteriorates. Be sure to separate paper that has already been printed with the  (cut) button. Before the paper is fed backward, separate the printed paper with the  (cut) button or set the [Settings For Paper Handling After Print] to other than [Do not cut (stop at cut position)] or [Do not cut (stop at specified position)]. <p>The [Settings For Paper Handling After Print] can be set in the [Media Settings] of the printer driver.  "Media (Paper) Settings" on page 93</p>
Horizontal (Printing Direction) White Banding	The nozzles are clogging.	<p>Use the [Print Head Nozzle Check] function to check the nozzles for clogging.  "Test Print" on page 79</p> <p>If the nozzles are clogging, run [Print Head Cleaning]. If the symptom persists after repeating [Print Head Cleaning] three or more times, run [Power Cleaning].  "Print Head Cleaning" on page 309</p> <p>If the auto nozzle check system is disabled, change it to enabled (default).  "Auto Nozzle Check System" on page 30</p>
White or Black Banding	The paper is not loaded correctly.	<p>Reload the paper.  "Loading Paper" on page 66</p>
	The paper being used and the Media Coating Type setting differ.	<p>Check the paper being used and the Media Coating Type setting of the printer driver.  "Printer driver for Windows" on page 91</p>
	White banding or black banding can occur if the paper feeding setting is not appropriate for the paper used.	<p>Perform [Adjust Uneven Colors]. Click on [Adjust Uneven Colors] in PrinterSetting.  "Adjust Uneven Colors" on page 204</p>
	The banding reduction setting is not appropriate.	<p>Color banding (unevenness) may become less noticeable by correcting the overlap of print areas of adjacent print heads. Change the [Banding Reduction] setting in the printer driver or PrinterSetting.  "Media (Paper) Settings" on page 93  "Print results adjustment" on page 193</p>

Status	Cause	Solution and Reference
Unintended Top and Bottom Margins are Generated	Use of die-cut labels (no black marks) that do not meet thickness requirements may cause the printer to incorrectly detect the label, resulting in unintended top and bottom margins on each label. (The "top and bottom" used here means the beginning and end of labels in the paper feed direction.)	Carry out [Print start position adjustment (Vertical direction)] of PrinterSetting. Enter a minus correction value to reduce the top margin, and enter a plus correction value to reduce the bottom margin. ☞ "Position adjustment" on page 191
Printed Colors Are Wrong	If the printer is moved after initial ink charging, the specified colors may not be output (colors may be mixed) due to vibrations and impacts.	Run a head cleaning and check that colors are no longer mixed. ☞ "Print Head Cleaning" on page 309
Blurred printing, Characters look doubled, Misalignment of print position	The edge guide is not set along the paper edge.	Check that the edge guide is properly set at the paper width position. ☞ "Loading Paper" on page 66 If this does not solve the problem, perform [Position adjustment] - [Print start position adjustment (Horizontal direction)] in PrinterSetting. ☞ "Position adjustment" on page 191
	The ink droplets fired at incorrect positions in both the paper-feed and paper-width directions.	Depending on the paper, the paper feed amount may not be appropriate, resulting in uneven colors. Perform [Adjust Uneven Colors] using the operation panel or PrinterSetting. ☞ "Adjust Uneven Colors" on page 204
	The gap between the paper and the print head is not appropriate.	Blurred print may occur when the printer settings are not appropriate for the thickness of the paper. Adjust [Head-Media Clearance Height] using the operation panel or PrinterSetting. ☞ "Adjusting Head-Media Clearance Height" on page 292



Status	Cause	Solution and Reference
Paper is Smearred or Smudged with Ink	The paper being used and the Media Coating Type setting differ.	Check the paper being used and the Media Coating Type setting of the printer driver.  "Printer driver for Windows" on page 91
	If foreign matter is adhered to the head, the paper may be smeared with ink.	Run a print head cleaning.  "Print Head Cleaning" on page 309
	The paper and print head may be rubbing against each other due to insufficient paper suction strength, resulting in soiled paper.	Depending on the paper used, the paper suction strength (Media Hold Pressure) may need to be changed. Carry out the manual adjustment using the printer driver following the steps below. 1. Display the [General] window of the printer driver. 2. Click [Advanced] in the [Media Settings] field. The advanced settings window appears. 3. Select the check box for [Media Hold Pressure] in the [Paper Adjustment] field. The manual adjustment is enabled. 4. Move the slide bar to adjust the platen vacuum.
	The gap between the paper and the print head is not appropriate.	Blurred print may occur when the printer settings are not appropriate for the thickness of the paper. Adjust [Head-Media Clearance Height] using the operation panel or PrinterSetting.  "Adjusting Head-Media Clearance Height" on page 292
The inside of the printer gets dirty.	The form of paper you are using is different from the paper form setting.	Check the paper being used and the Media Form setting of the printer driver. Do not use die-cut labels with the [Full-page Label] setting. Ink drops fired on the backing paper (release liner) may cause contamination inside the printer and lead to problems.
Part of print data is trimmed/Auto cut position is Incorrect	The paper being used and the media definition do not match.	If the paper and the media definition of the printer driver do not match, printing may not be at the correct position. Set the media definition correctly.  "User-Defined Paper" on page 98
	Shift of print and stop position may occur depending on the paper used.	Adjust the print start position using PrinterSetting.  "Position adjustment" on page 191

Status	Cause	Solution and Reference
Poor barcode print quality	The paper being used and the Media Coating Type setting differ.	Check the paper being used and the Media Coating Type setting of the printer driver.  "Printer driver for Windows" on page 91
	The bar width has not been corrected.	In order to print barcodes properly, the bar width of the barcode in the printed data must be corrected. <ul style="list-style-type: none">• If you are using the printer driver, select the [General] tab, click [Advanced], select the check box for [Bar Width Adjustment], and set it to an appropriate level. However, the printer driver's bar width adjustment only works when using the printer driver's barcode font, and not in other cases.  "Printing Barcodes" on page 108• If you are using an application that generates barcodes, correct the bar width in that application. For instructions on how to set it in the application, refer to the application manual.
	The ink profile or black ink ratio setting needs to be changed.	Depending on the paper, the ink ejection amount may need to be adjusted to ensure barcode print quality. If you are using the printer driver, select the [General] tab, click [Advanced], select the check box for [Ink Profile] or [Ratio of Black to Composite], and set it to an appropriate level. Contact the distributor from whom you purchased the printer for the appropriate level for each paper.
The size of the print area does not match the paper size	This is a product specification and not an abnormality.	When using the printer driver, the printable area is the label size minus the 1.5 mm {0.06 in.} top, bottom, left, and right margins. If you want to print on entire surface of labels, provide 1.5 mm {0.06 in.} top, bottom, left and right margins in the print data to avoid printing on backing paper as much as possible.  "Printable Area" on page 383
When printing on continuous paper or full-page labels, margins appear in the paper feed direction	This is a product specification and not an abnormality.	It is not possible to print on all areas of continuous paper or full-page labels in the paper feed direction. Check the print area of the paper before printing.  "Printable Area" on page 383
Some or all of ink droplets are not fired on paper	The print area does not match the paper you are using.	Check if the print area is set correctly.  "Printable Area" on page 383

Cannot Print

Status	Cause	Solution
Auto Paper Feeding does Not Start	The sensor has failed.	If operation was normal up until now, the sensor has probably failed. Request repairs.
	The position of the gap detector is not correct.	Check the position of the gap detector.  "Adjusting the Gap Detector" on page 294
	The printer cannot detect the paper properly.	If you are using special paper, the paper may not be fed into the printer automatically. Feed the paper manually.  "Feeding Paper into the Printer Manually" on page 78
Unstable paper detection performance "Unstable" means that: <ul style="list-style-type: none"> • Print start position is inconsistent. • Some labels are skipped without being printed • When paper is loaded, the paper is fed more than necessary, resulting in an error. • A paper size error occurs even though the correct paper size is set 	The gap detector may be incorrectly positioned.	Make sure that the light-receiving detector tab and the light-emitting detector tab are in the same position, then calibrate the detector. How to align the gap detectors:  "Adjusting the Gap Detector" on page 294 How to calibrate the detector:  "Adjusting Detectors Sensitivity and Label Detection Thresholds" on page 293
	The edge guide is not set along the paper edge.	Check that the edge guide is properly set at the paper width position.
When paper is loaded, the paper is fed more than necessary, resulting in an error. Paper Form: Full-page label (without black marks)	The paper being used differs from that of Media detection settings.	Check the paper being used and Media detection settings of the printer.  "Paper Source and Paper Detection Settings" on page 103

Status	Cause	Solution
When paper is loaded, the paper is fed more than necessary, resulting in an error. Paper Form: Die-cut label (Gap)	The paper being used differs from that of Media detection settings.	Check the paper being used and Media detection settings of the printer. 🔗 "Paper Source and Paper Detection Settings" on page 103
	The transmittance of the paper does not meet the specifications of the printer.	Depending on the transmittance of the paper, the printer may not be able to detect gaps in the paper. Since infrared light is used for the paper gap detection, the IR light transmittance must be above the specified value for the backing paper and below the specified value for the labels. Check the specifications of the paper, and use paper that satisfies the printer's requirements. 🔗 "Paper Detection System" on page 390 As an alternative, adjusting the gap detector may allow the printer to detect the paper properly. On the operation panel, select [Menu] - [Maintenance] - [Calibration] - [Simple Media Detect] in that order. If the problem is not resolved, carry out [Media Detect].
	The sensor has failed.	If the printer has been working properly up to now, the sensor may be faulty. Request repairs.
When paper is loaded, the paper is fed more than necessary, resulting in an error. Paper Form: Full-page label (Black Mark), Die-cut label (Black Mark)	The paper being used differs from that of Media detection settings.	Check the paper being used and Media detection settings of the printer. 🔗 "Paper Source and Paper Detection Settings" on page 103
	The black marks do not meet the specifications of the printer.	If the reflectivity of the black marks is higher than the specified value, the black marks may not be recognizable. Infrared light is used for black mark detection, and the infrared reflectivity needs to be the specified value or lower. Check the specifications of black mark printing, and use black marks that meet the printer specifications. 🔗 "Paper Detection System" on page 390 As an alternative, adjusting the black mark detector may allow the printer to detect black marks on paper. On the operation panel, select [Menu] - [Maintenance] - [Calibration] - [Simple Media Detect] in that order. If the problem is not resolved, carry out [Media Detect].
	The sensor has failed.	If the printer has been working properly up to now, the sensor may be faulty. Request repairs.

Status	Cause	Solution
<p>When paper is loaded, the paper is fed more than necessary, resulting in an error.</p> <p>Paper Form: Tag</p>	<p>The paper being used differs from that of Media detection settings.</p>	<p>Check the paper being used and Media detection settings of the printer.</p> <p> "Paper Source and Paper Detection Settings" on page 103</p>
	<p>The holes, oblong holes, and cutouts, which are provided for paper detection, do not meet the specifications of the printer.</p>	<p>If the size of the holes, oblong holes, or cutouts do not meet the printer's specifications, the printer may not recognize them. Check the specifications of the tag, and use tag that satisfies the printer's requirements.</p> <p> "Paper Specifications" on page 370</p> <p>As an alternative, adjusting the gap detector may allow the printer to detect the paper properly.</p> <p>On the operation panel, select [Menu] - [Maintenance] - [Calibration] - [Simple Media Detect] in that order. If the problem is not resolved, carry out [Media Detect].</p>
	<p>The sensor has failed.</p>	<p>If operation was normal up until now, the sensor has probably failed. Request repairs.</p>

Cannot Print Continuously

Status	Cause	Solution
Printing stops halfway through	The printer is waiting for data from computer	Open [Printer Properties], select the [Advanced] tab, and enable [Start printing after last page is spooled].
	The printer is not processing data in time. (Cannot prepare the next print data while printing one sheet)	Reduce the amount of variables and images contained in the data to be printed.
	Accuracy of gaps in the die-cut label is poor	Use die-cut labels with high dimensional accuracy.
	Printing is interrupted by head maintenance	The [Head Maintenance] setting may be set to [Pause for Maintenance] which is the default setting. With the [Pause for Maintenance] setting, printing stops for head maintenance about once every 20 seconds. Change the setting to [Continuous Printing].

Cannot Feed Paper from Outside the Printer

Status	Cause	Solution
Cannot select gap detection method for fanfold paper	This is a product specification and not an abnormality.	To prevent jamming of fanfold paper, fanfold paper with a thicker backing than that of roll paper must be used. Due to the thickness, the printer may not be able to detect gaps in the paper, even if it is genuine paper. Adjusting the gap detector threshold in the printer driver will increase the range of paper that can be used, but even then, not all paper can be guaranteed. For this reason, the printer is designed not to allow gap detection settings for fanfold paper. The printer allows gap detection only for roll paper because the backing is the same in thickness as that of paper.

Network Connection Check Errors

Check the error number printed on the connection check report and take measures correspond to the error number.

For instructions on how to print the report, see "[Checking Network Connection and Settings](#)" on page 41.

Error Code

Error number	Solution
E-1	<ul style="list-style-type: none"> • Check that the LAN cable is securely connected to the printer and the other network devices such as a hub. • Check that the network device such as a hub is powered on.
E-2 E-3 E-7	<ul style="list-style-type: none"> • Make sure that the access point is turned on. • Make sure that your computer or other devices are communicating properly with the access point. • Keep the printer and access point close together. Remove any obstacles in between. • If you entered the SSID directly, make sure that the SSID you entered is correct. You can check the SSID in the network settings column on the connection check report. • When setting up with push-button auto-configuration, make sure the access point supports AOSS/WPS. If the access point does not support AOSS/WPS, push button automatic setting cannot be used. • Make sure that the SSID does not use any character string other than ASCII characters (alphanumeric characters and symbols). The printer cannot display SSIDs that contain non-ASCII character strings. • When connecting to an access point, confirm the SSID and password beforehand. If you are using an access point with the manufacturer's settings, the SSID and password will be written on the label of the access point. If you don't know the SSID and password, check with the person who set up the access point, or refer to the manual for the access point. • If you want to connect to the SSID generated by the tethering function of your smart device or other devices, check the manual of your smart device for the SSID and password. • If you are suddenly unable to connect to your wireless LAN (Wi-Fi), check the following. If any of the following apply to you, please use the installer to reconfigure your network settings. The installer can be obtained from the following website. https://epson.sn <ul style="list-style-type: none"> * Have you newly set up your network environment with push-button auto-configuration (AOSS/WPS) from another smart device? * Has this wireless LAN (Wi-Fi) network been configured using a method other than push-button auto-configuration? * Are you using an access point manufactured by Buffalo Corporation that can be set up using push buttons (AOSS)?
E-5	<p>Check if the access point has one of the following security methods. If not, change the access point settings to use one of the following security methods, and reconfigure the network settings of the printer.</p> <ul style="list-style-type: none"> • WEP-64 bit (40 bit) • WEP-128 bit (104 bit) • WPA PSK (TKIP/AES)* • WPA2 PSK (TKIP/AES)* • WPA (TKIP/AES) • WPA2 (TKIP/AES) • WPA3 SAE (AES)* <p>* WPA PSK is also referred to as WPA Personal, WPA2 PSK as WPA2 Personal, and WPA3 SAE as WPA3 Personal.</p>

Error number	Solution
E-6	<ul style="list-style-type: none"> • Make sure that MAC address filtering is disabled. If enabled, please register the MAC address of the printer to prevent it from being filtered. For details, please refer to the manual of the access point. You can check the MAC address of the printer in the network settings column on the connection check report. • If Shared authentication is enabled in the access point's WEP security method, make sure that the authentication key and index are correct.
E-8	<ul style="list-style-type: none"> • When the TCP/IP setting of the printer is set to automatic, enable DHCP on the access point. • When the TCP/IP setting of the printer is set to manual, the manually set IP address is invalid because it is outside the valid range (such as 0.0.0.0). Set a valid IP address using the operation panel of the printer or using Web Config.
E-9	<p>Check the followings.</p> <ul style="list-style-type: none"> • Is the device that uses the printer turned on? • From the device that uses the printer, is it possible to access the Internet and connect to other computer or network devices on the same network? <p>If there are no problems, please use the installer to reconfigure your network settings. The installer can be obtained from the following website. https://epson.sn</p>
E-10	<p>Check the followings.</p> <ul style="list-style-type: none"> • Are the other devices on the network turned on? • If you have set the printer's TCP/IP settings manually, is the network address (IP address, subnet mask, and default gateway) correct? <p>If the network address is incorrect, correct it. You can check the IP address, subnet mask, and default gateway in the network settings column on the connection check report. If you have enabled DHCP, set the IP address to Auto in the printer's TCP/IP settings. If you want to set the IP address manually, check the printer's IP address in the network settings column on the connection check report, then set the address in the printer's network settings screen. Set the subnet mask to "255.255.255.0".</p>
E-11	<p>Check the followings.</p> <ul style="list-style-type: none"> • If you have set the printer's TCP/IP settings manually, is the default gateway address correct? • Is the device specified as the default gateway turned on? <p>Set the correct default gateway address. You can check the default gateway address in the network settings column on the connection check report.</p>
E-12	<p>Check the followings.</p> <ul style="list-style-type: none"> • Are the other devices on the network turned on? • Is the network address (IP address, subnet mask, default gateway) of the printer that you set manually correct? • Are the network addresses (subnet mask and default gateway) of other devices the same? • Is the IP address of the printer duplicated with other devices? <p>If there are no problems, try the following.</p> <ul style="list-style-type: none"> • On a computer on the same network as the printer, use the installer to reconfigure the network settings. The installer can be obtained from the following website. https://epson.sn • The security type "WEP" allows multiple security keys to be registered to the access point. When multiple keys are registered, make sure that the security key for the first (primary) index is set to the printer.

Error number	Solution
E-13	<p>Check the followings.</p> <ul style="list-style-type: none"> • Are network devices (access points, hubs, routers, etc.) turned on? • Are the TCP/IP settings of network devices other than the printer set manually? (If the TCP/IP settings of other network devices are set manually, but only the printer's TCP/IP settings are set automatically, only the printer may be on a different network.) <p>If there are no problems, try the following.</p> <ul style="list-style-type: none"> • On a computer on the network to which the printer is connected, use the installer to reconfigure the network settings. The installer can be obtained from the following website. https://epson.sn <p>The security type "WEP" allows multiple security keys to be registered to the access point. When multiple keys are registered, make sure that the security key for the first (primary) index is set to the printer.</p>

Messages about the network environment

Message	Solution
Multiple specified networks (SSIDs) were found. Please check.	There is a possibility that the same SSID is set for multiple access points. Please check the settings of the access point and change the SSID.
The wireless environment needs to be improved. Turn off the access point and then back on. If the problem persists, please refer to the manual of the access point.	Move the printer closer to the access point, turn off the access point and then back on. If the problem persists, please refer to the manual of the access point.
The maximum number of devices that can be connected wirelessly has been reached. If you want to add a device, please disconnect other devices.	Up to 8 wireless devices can be connected at the same time via Wi-Fi Direct (Simple AP) connection. To add another computer or smart device, disconnect the computer or smart device that is not using the printer before adding it.

Unable to Connect to the Network

Problem with Wireless LAN Network Device(s)

Turn off the power of all devices connected to the network. Wait about 10 seconds, then turn on the wireless router (access point), computer or smart device, and printer, in that order. Move the devices closer to the wireless router (access point) so that they can receive radio waves more easily, and reconfigure the settings.

The Devices and the Wireless Router are Too Far Apart to Receive Signals

Move the computer or smart device and printer closer to the wireless router, and then turn the router back on.

Wireless LAN Settings do Not Match with a Replaced New Router

Reconfigure the settings to match the new router.

Computer or Smart Device and Printer are Connected to Different SSIDs

If you are using multiple wireless routers or a single wireless router that can use multiple SSIDs, you cannot connect a computer or smart device to a printer if the computer or smart device and the printer are connected to different SSIDs.

Connect the computer or smart device to the same SSID as the printer.

- Check the SSID to which the printer is connected by printing a network connection check report.
- Check the name of the Wi-Fi or network you are connected to on all computers and smart devices you want to connect to the printer.
- If the printer and computer or smart device are connected to different networks, reconnect the computer or smart device to the same SSID as the printer.

Privacy Separator Function of the Wireless LAN Router is Enabled

Many wireless LAN routers (access points) and mobile routers have a privacy separator function that blocks communication between devices. If you cannot communicate between the printer and your computer or smart device even though they are connected to the same SSID, disable the privacy separator function on your wireless router (access point). For details, refer to the manual of your wireless router (access point).

IP Address has Not been Assigned Correctly

If the IP address is "169.254.XXX.XXX" and the subnet mask is "255.255.0.0", the IP address may not have been assigned correctly.

On the printer's operation panel, select [Settings] - [Network Settings] - [Advanced] - [TCP/IP], and check the IP address and subnet mask assigned to the printer.

Restart the wireless router or reconfigure the network settings of the printer.

Radio Frequency Interference caused by Device Connected to USB 3.0 port

Radio frequency interference may occur when using a device connected to a Mac's USB 3.0 port. If you are unable to connect the printer to a wireless LAN (Wi-Fi) or the connection is unstable, try the following.

- Move the device connected to the USB 3.0 port away from the computer

Problem with the Network Settings of the Computer or Smart Device

Make sure you can browse the website from your computer or smart device. If you are unable to view the website, there may be a problem with your computer or smart device network settings.

Please check the network connection of your computer or smart device. For more information, refer to your computer or smart device manual.

A Message Appears on the Computer Screen

If the following screen appears, resolve the problem following the instructions on the screen.

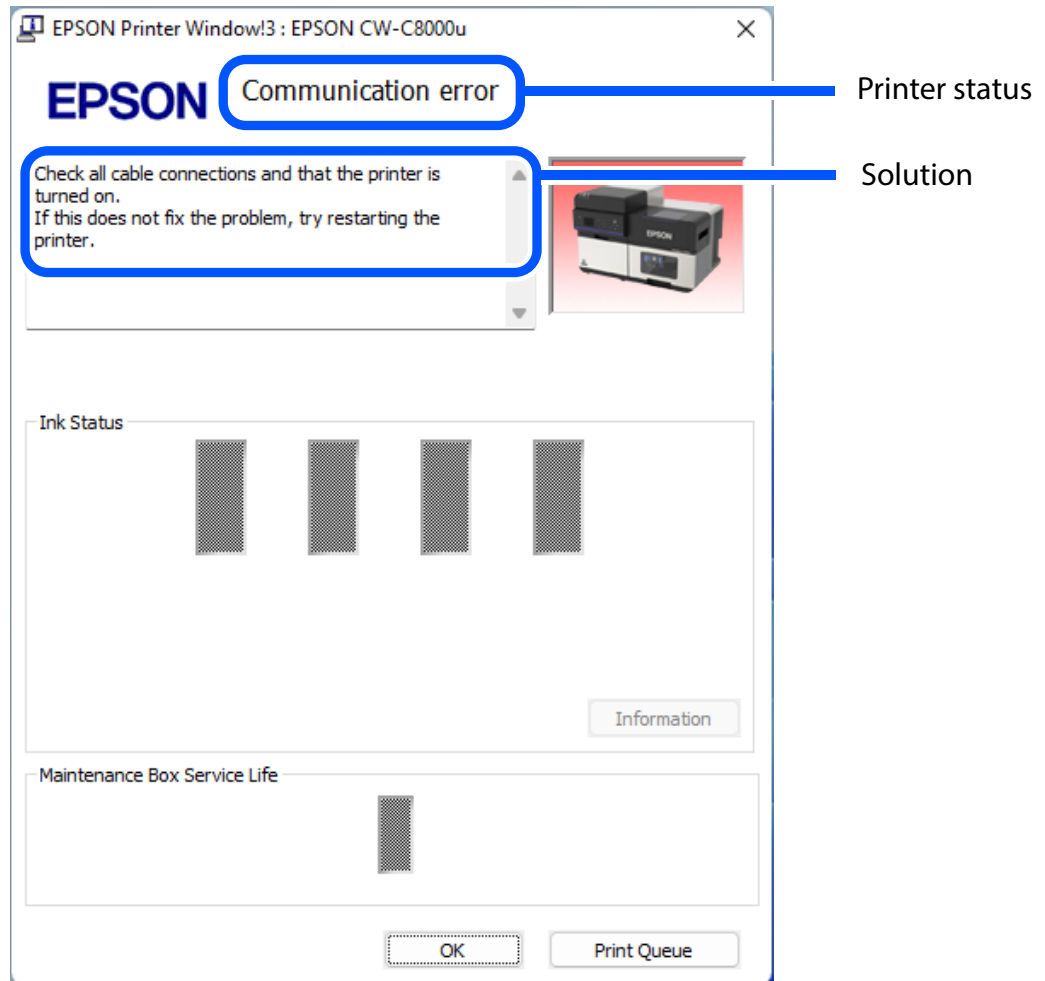

Printing from a Computer is Impossible or Becomes Suddenly Impossible

Checking Whether the Printer Driver Is Installed

Check whether or not the required software and applications are installed on the computer.

To print with this printer, a printer driver is required. Check whether or not the printer driver is installed by following the steps below.

- 1 Open [Printers & scanners].**
- 2 Check that the printer name is displayed.**
If not, the printer driver is not installed.
- 3 Install the printer driver.**
(["Downloading Printer Driver, Utilities, and Manuals" on page 403](#))

Reconnecting the Printer and Computer

- 1 Check the cable connections.**
Check that the power cable and the USB cable or wired LAN cable are connected properly.
If connected wirelessly, check that the wireless LAN unit is properly connected to the printer.
- 2 Reconnect all of the devices.**
For USB connection
 - Disconnect the USB cable and then reconnect it.
 - If the computer has multiple USB ports, connect the cable to a different port.For wired LAN connection
 - Device connected by wired LAN may have become unstable. Restart the network function.
 - Turn off the all devices.
 - Wait about 10 seconds, then turn on the network device, computer, and printer in that order.For wireless LAN connection
 - Disconnect the optional wireless LAN unit and reconnect it.
 - Turn off the all devices.
 - Wait about 10 seconds, then turn on the wireless LAN router (access point), computer, and printer in that order.
- 3 Check that data is sent from the computer to the printer.**
For the check procedure, see ["Checking the Print Data" on page 332](#).

Checking the [Printers & scanners]

If the printer icon is not displayed in the [Printers & scanners] window, the printer device may have been deleted. Add the printer again following the procedure below.

- 1 Turn off the printer.**
- 2 Disconnect the USB cable from the computer.**
- 3 Wait for about 10 seconds, and then reconnect the USB cable to the computer.**
- 4 Turn the printer on.**
The printer icon is now displayed in the [Printers & scanners] window.

Checking the Print Data

If print data is not sent from a computer to the printer, it may be caused by print jobs remaining on the computer, or print jobs that has been paused or offline setting.

Check it following the procedure below.

- 1 Open [Printers & scanners].**
- 2 Set the printer as the default printer.**
Right-click the icon of the printer to be used and then click Set as default printer.
If the printer is installed multiple times, copies of the printer driver may be created.
If there is more than one printer icon and you find a copied one such as "CW-C6XXX (Copy 1)", click on the copied icon and then delete it by clicking [Remove device].
- 3 Perform a test print to check whether or not the print data is sent to the printer.**
Click the icon of the printer being used and then click [Printer properties].
- 4 The printer properties screen of the printer driver appears. Click [Print Test Page] on the [General] tab.**
If the test print is successful, you have confirmed that data is sent from the computer to the printer.
- 5 Display the print job. Click the icon of the printer being used and then click [Open queue].**
- 6 A screen appears. Check the print job.**
If print data is displayed, select [Cancel All Document] from the [Printer] menu.
If the print data cannot be deleted, restart the computer.

7 Check "Pause Printing" or "Use Printer Offline" is not set for the printer.

Select [Printer] and make sure that [Pause Printing] or [Use Printer Offline] is not selected. If any of them is checked, clear the check mark.

The Printer does Not Turn On

Check that the power cable is connected to the printer and outlet properly. (["Connecting the Power Cable" on page 46](#))



Print Job is Canceled on PC but “Printing” Message Still Appears on the Printer

If you cancel printing in printer queue on the computer, it may cause the print data to break up and “Printing” may be kept displayed on the operation panel of the printer.

To cancel the status, press the  (cancel) button on the operation panel, and then select [All label formats].

If you are still unable to cancel after performing the above steps, restart the printer.

Error Beep Sound Does Not Stop

If the printer has been set to sound the error beep continuously, press the  (home) button or the  (back) button on the operation panel to stop the beep sound.

Paper Jam

Roll Paper is Jammed

- 1 Open the paper cover.

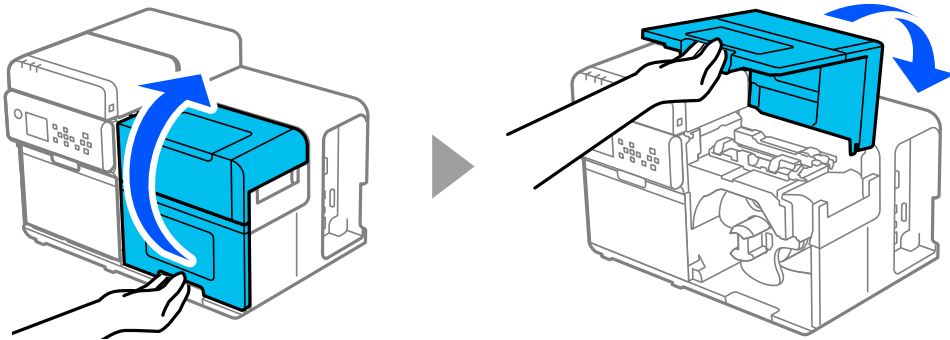

- 2 Push the lever backward and open the top cover.

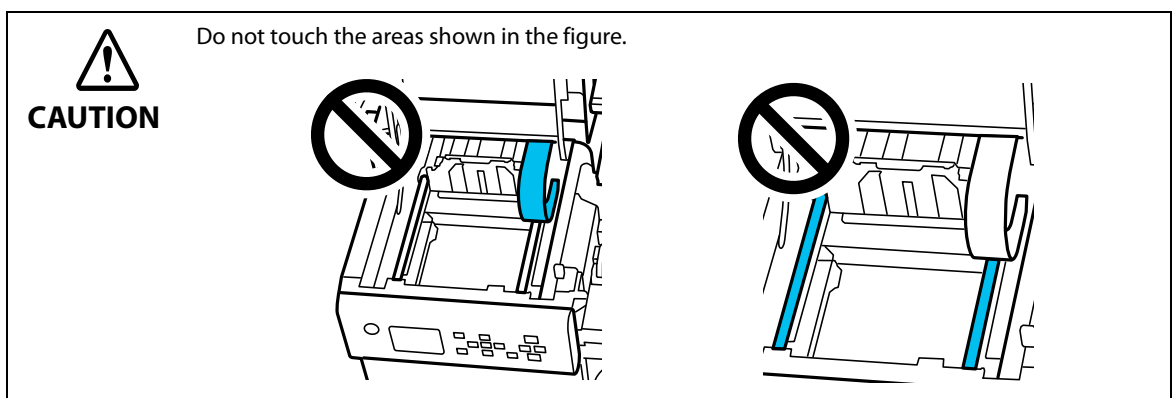
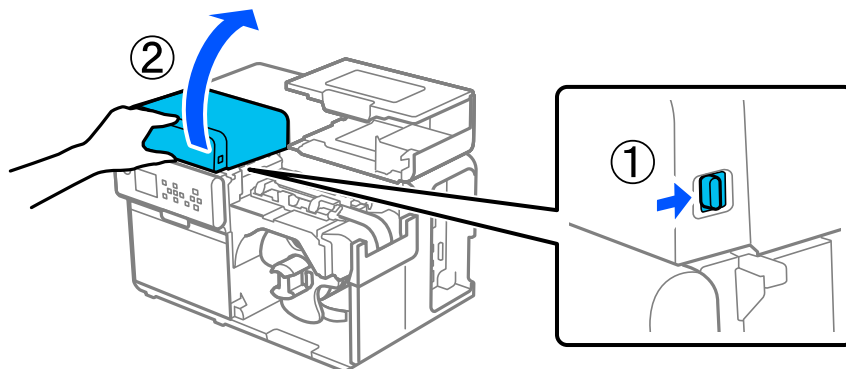

3 Raise the paper holds.

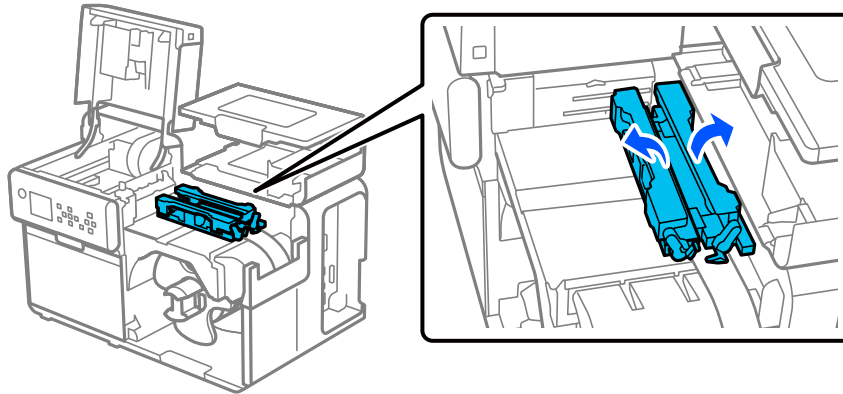

4 While pressing the blue lever, slide the movable edge guide toward you until it stops.

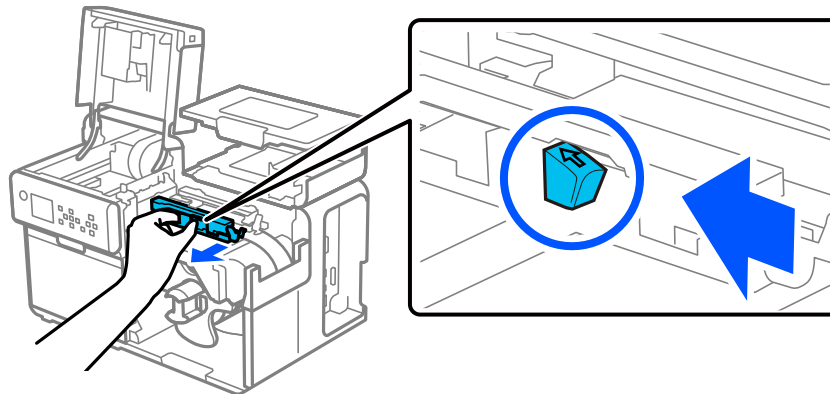

5 Raise the pressure unit with your finger placed on the tab (shown inside the circle below) and confirm that no labels is stuck to the pressure unit.

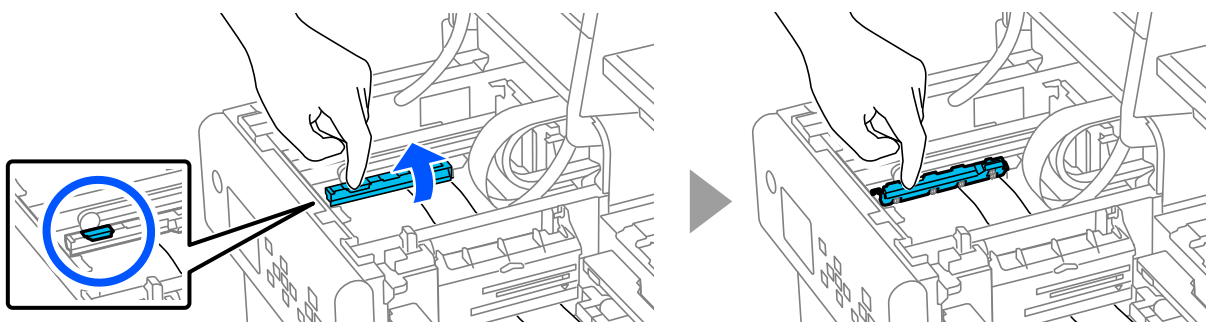
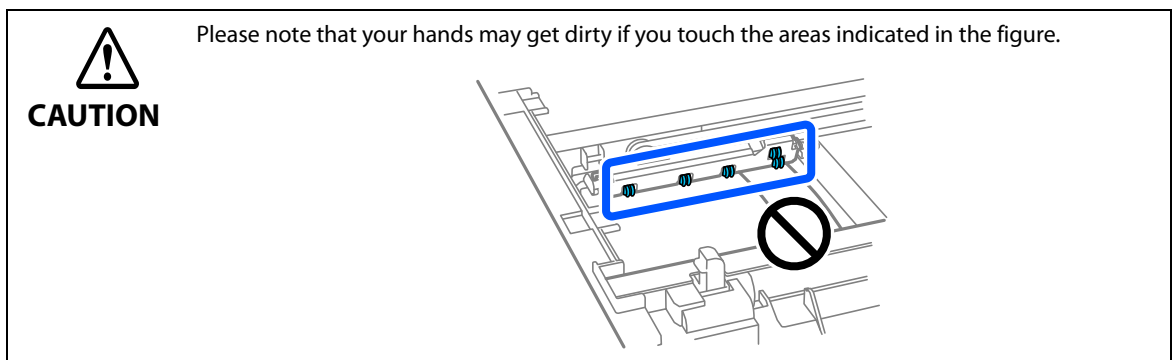

- 6** Raise the paper feed slot cover with your finger placed on the tab (shown inside the circle below) and confirm that no labels is stuck to the paper feed slot cover.

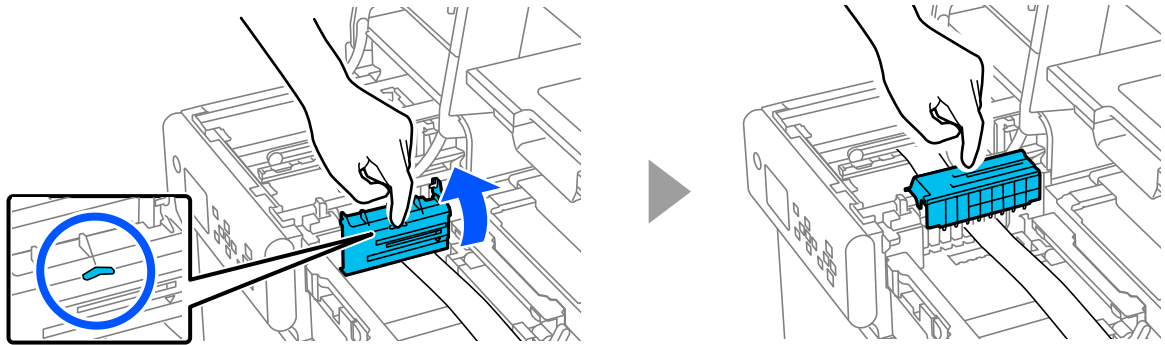

- 7** Manually cut the paper.

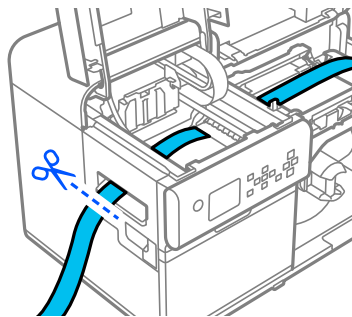

- 8** Retract the paper, being careful not to get ink on your hands.

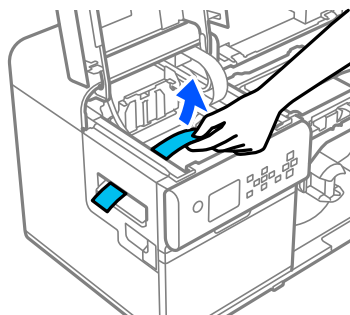

- 9** Manually cut the paper near the paper pressure rollers and remove it.

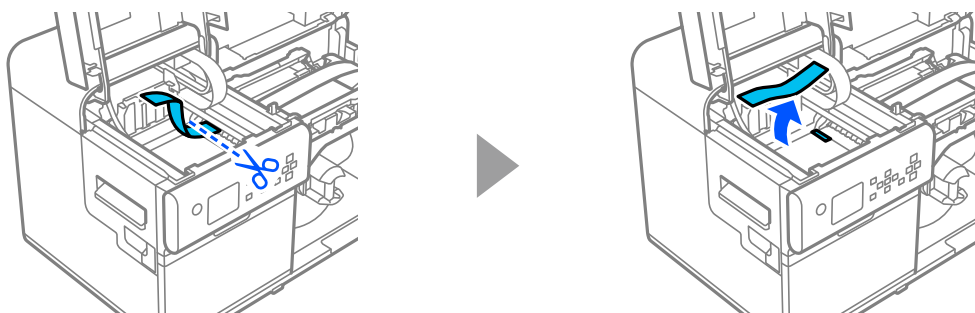

- 10** Wind up the paper by turning the roll paper flange clockwise until the leading edge of the paper passes through the paper feed slot.

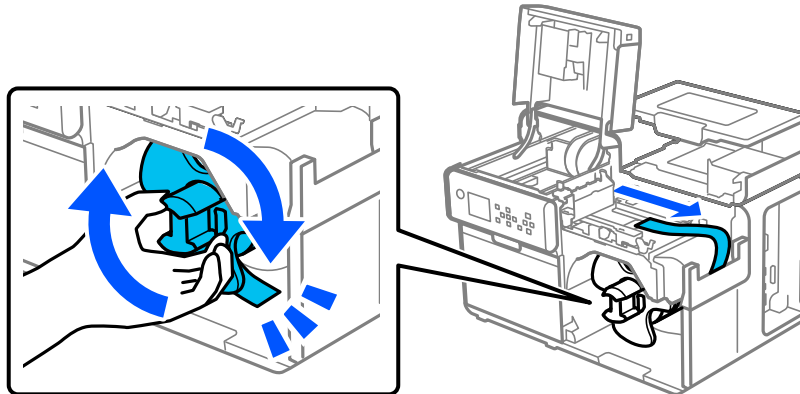

- 11** Close the paper cover.

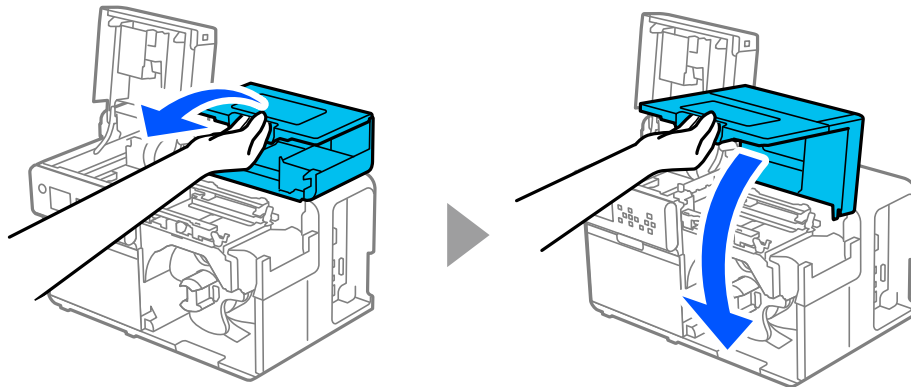

- 12** Close the top cover.

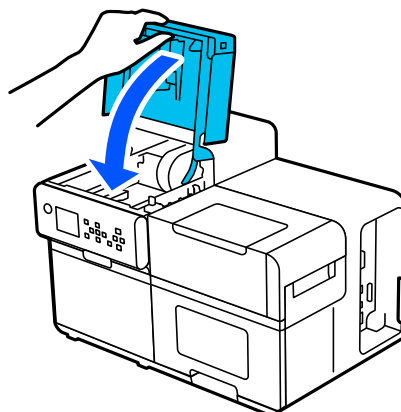

13 Press the **||** (pause) button.

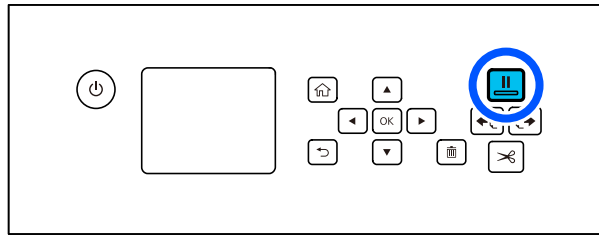

To load paper, see "[Loading Roll Paper](#)" on page 67.



After removing jammed paper, make sure that there is no labels or adhesive left inside the printer. If you use the printer without removing them, it leads to frequent paper jams, or may cause poor print quality.

 ["Cleaning the Edge Guides" on page 303](#)

 ["Cleaning the Paper Pressure Roller" on page 305](#)

Fanfold Paper is Jammed

- 1 Open the paper cover.

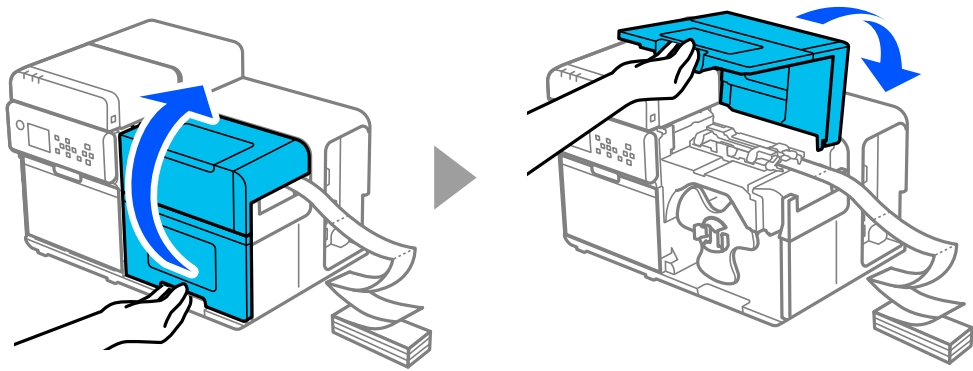

- 2 Push the lever backward and open the top cover.

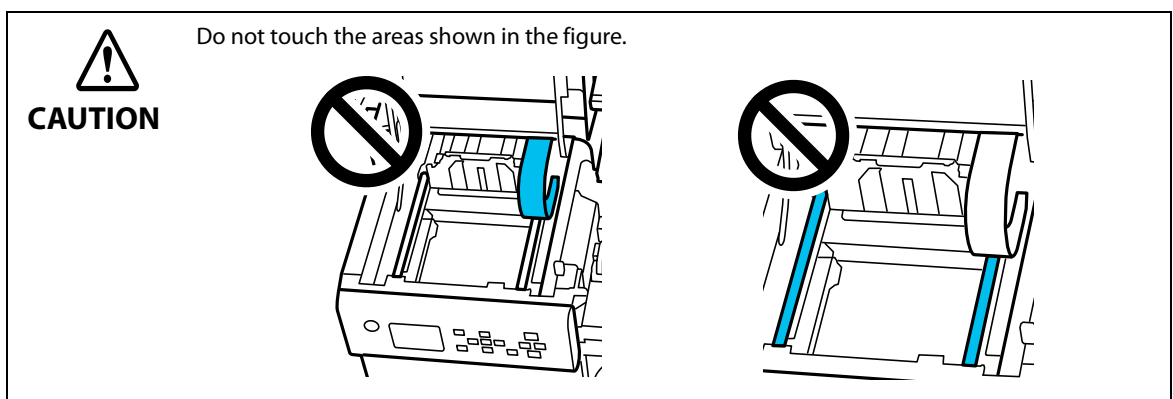
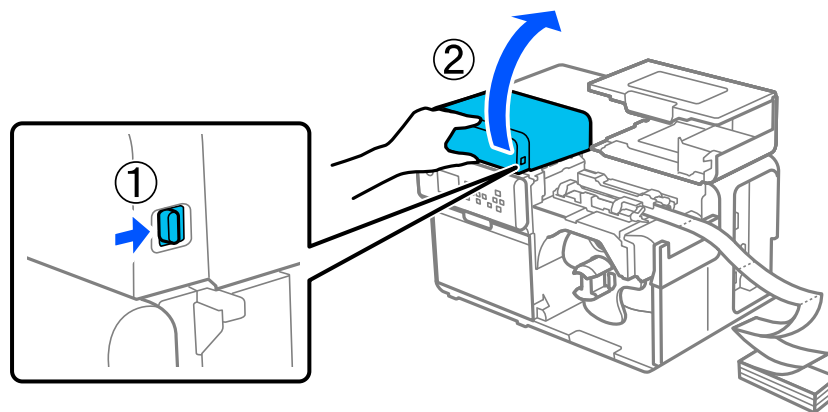

3 Raise the paper holds.

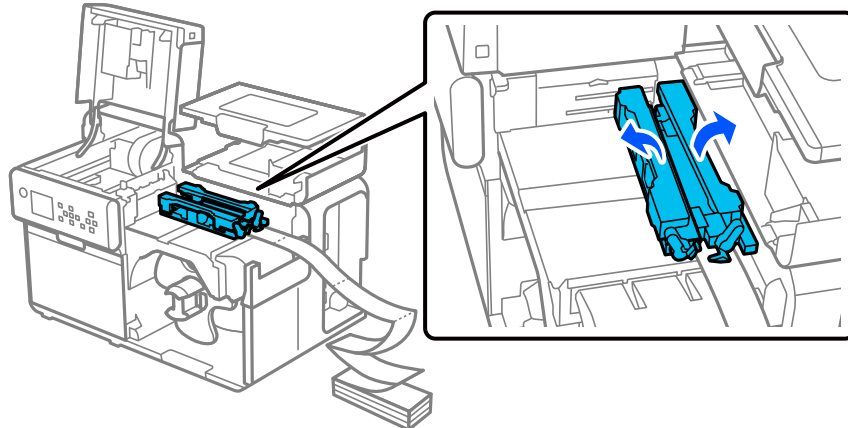

4 While pressing the blue lever, slide the movable edge guide toward you until it stops.

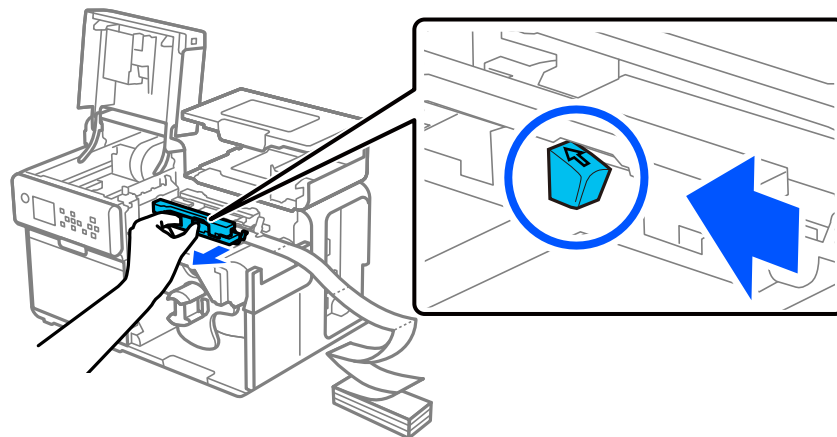

5 Raise the pressure unit with your finger placed on the tab (shown inside the circle below) and confirm that no labels is stuck to the pressure unit.

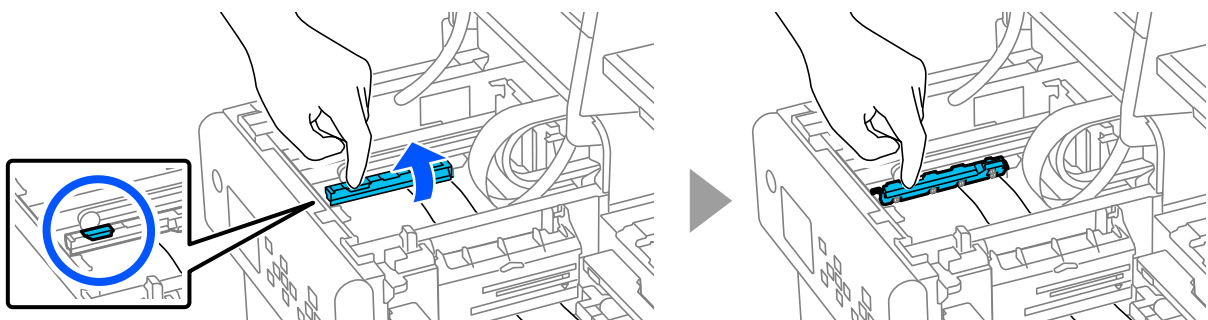
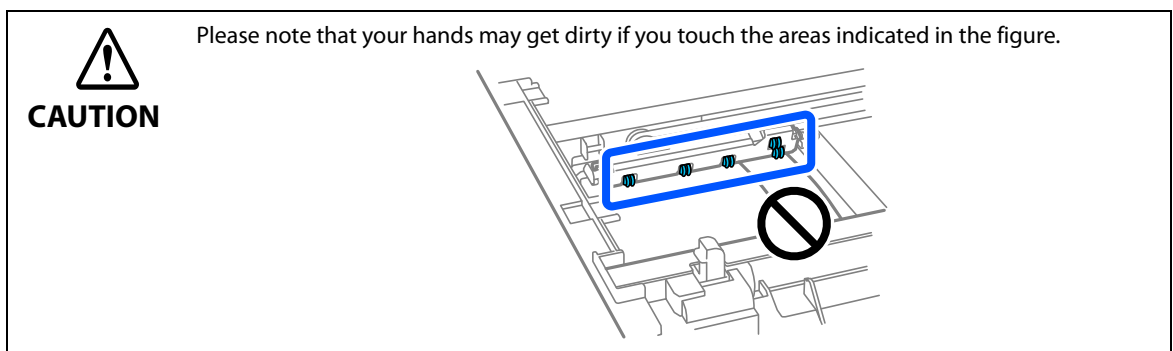

- 6** Raise the paper feed slot cover with your finger placed on the tab (shown inside the circle below) and confirm that no labels is stuck to the paper feed slot cover.

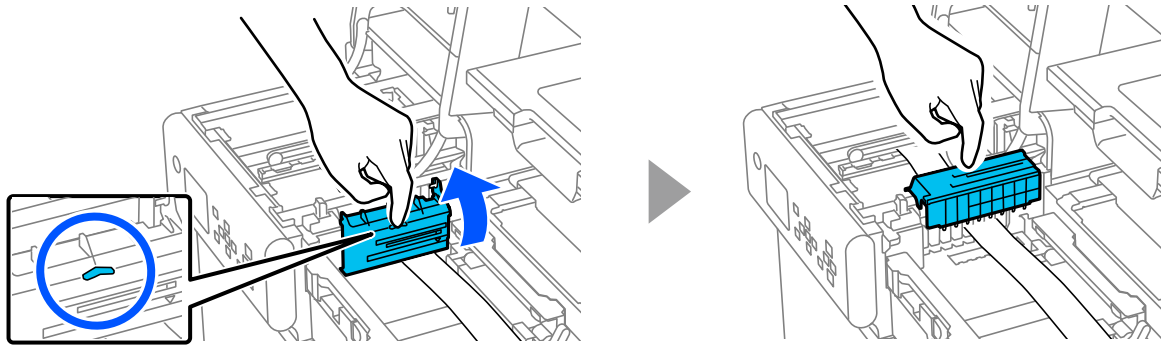

- 7** Manually cut the paper.

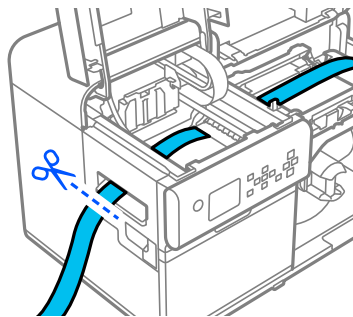

- 8** Retract the paper, being careful not to get ink on your hands.

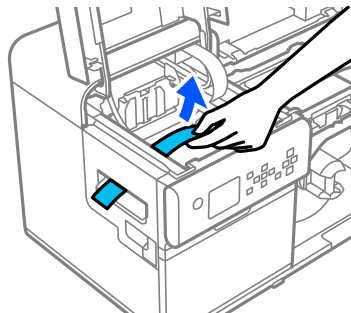

- 9** Manually cut the paper near the paper pressure rollers and remove it.

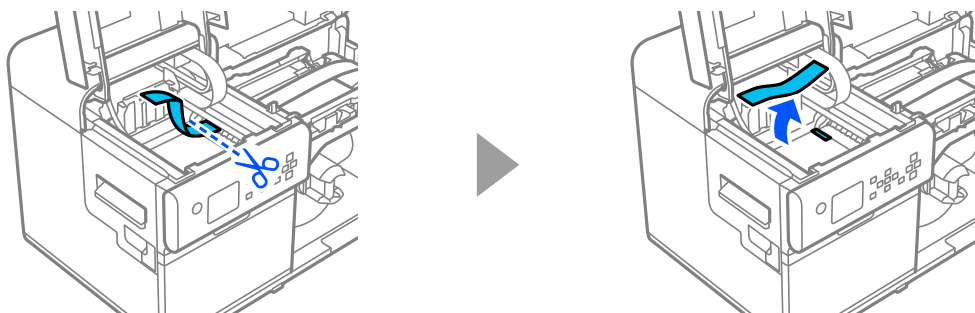

10 Pull out the paper through the paper feed slot.

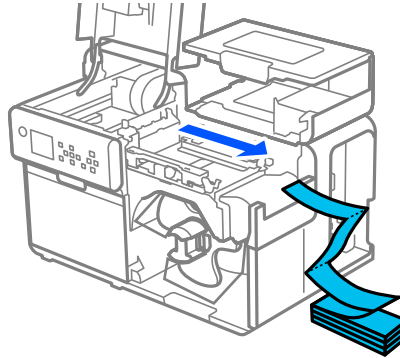

11 Close the paper cover.

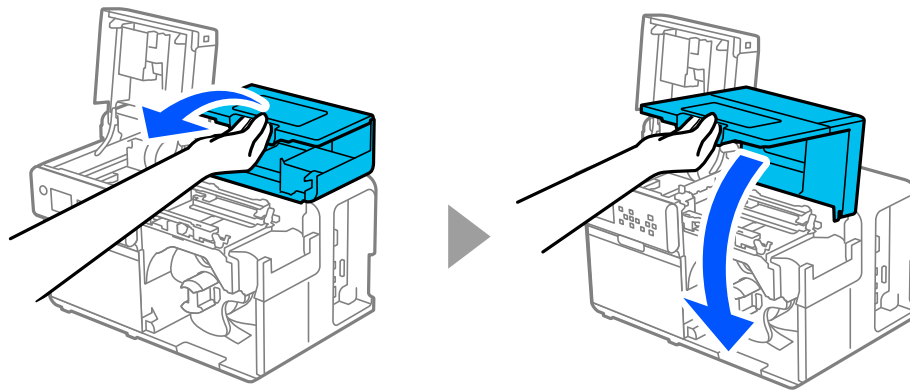

12 Close the top cover.

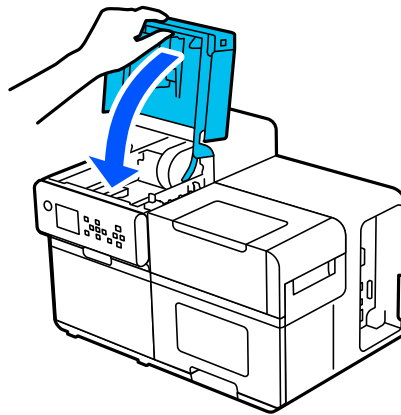

13 Press the **||** (pause) button.

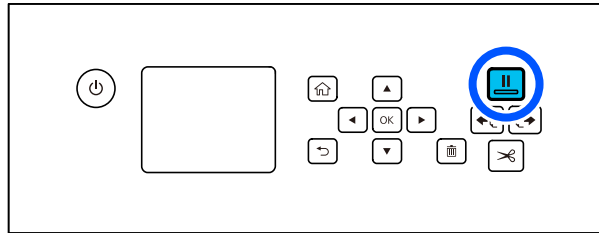

To load paper, see "[Loading Fanfold Paper](#)" on page 72.



After removing jammed paper, make sure that there is no labels or adhesive left inside the printer. If you use the printer without removing them, it leads to frequent paper jams, or may cause poor print quality.

[Cleaning the Edge Guides](#) on page 303

[Cleaning the Paper Pressure Roller](#) on page 305

Information for Application Development

This chapter provides printer control methods and other information necessary for developing an application.

How to Control the Printer

The printer control method differs depending on how to print from the printer.

Application specifications	Printer control method	Page
Print using the printer driver that is installed following the setup workflow described in chapter 2.	Use the printer driver.	Page 91
Print using the Epson Inkjet Label Printer SDK from Windows applications you developed.	Use the Epson Inkjet Label Printer SDK commands.	Page 346
Print using your application that directly controls ESC/Label commands.	Use the ESC/Label commands.	Page 347
Print using an existing application and printer driver that were used for a ZPL II compatible monochrome printer. Change from preprint system to on-demand print system.	Change the printer settings to replace the printer.	Page 348
Print using a Linux driver that has been rebuilt from the Linux driver source code to match the Linux OS of the distribution you are using.	Use the rebuilt printer driver for Linux.	Page 177
Print using the Linux driver source code from your application.	Use the source code of the Linux driver.	Page 177
Print using the iOS SDK from iOS applications you developed.	Use the iOS SDK.	Page 347
Print using the Android SDK from Android applications you developed.	Use the Android SDK.	Page 347
Print using the Web Application SDK from Web applications you developed.	Use the Web Application SDK.	Page 347

Using the Epson Inkjet Label Printer SDK

The SDK provides you an environment required for your application to print through the Epson printer driver. The followings are included.

Item	Description
Epson Inkjet Label Printer SDK User's Guide	Describes overview of Epson Inkjet Label Printer SDK configuration, functions required for controlling the Epson inkjet label printer from an application, how to use the sample programs, and printer driver settings that need to be configured in advance.
EPDI (EPSON Printer Driver Interface)	EPDI (EPSON Printer Driver Interface) provides application programming interfaces of Epson printer driver. By using the EPDI, you can configure the Epson printer driver settings from your application. For details about EPDI and information necessary to use it on your application programming, see "EPDI for Inkjet Label Printer Reference Guide" included in this SDK.
EpsonNet SDK	EpsonNet SDK provides API commands to get status of Epson inkjet label printer. For details about the API and information necessary to use it on your application programming, see "EpsonNet SDK for Windows Reference Guide" included in this SDK.
Label Print Sample Program	Provides executable files and source files of the program that perform printing from Epson inkjet label printer using Epson Inkjet Label Printer SDK. For instructions on how to use the sample programs, see "Epson Inkjet Label Printer SDK User's Guide".

Operating Environment

OS	Refer to the Appendix.
Software	Printer driver Please download it from the following website. For customers in North America, go to the following web site: https://www.epson.com/support/ For customers in other countries and regions, go to the following web site: https://epson.sn

How to Get Software

Contact qualified service personnel.

Using the iOS SDK/Android SDK/Web Application SDK

The SDKs are development kits for controlling an ESC/Label command-enabled printer from a web application or a native application on a smart device. They include library, manual, sample programs, etc.

How to Get Software

Contact qualified service personnel.

Using the ESC/Label Commands

The ESC/Label commands allow you to print directly from your application without using the printer driver.

How to Get Software

Please follow the instructions at the URL below.

For customers in North America, go to the following web site:

<https://www.epson.com/support/>

For customers in other countries and regions, go to the following web site:

<https://epson.sn>

Replacing from ZPL II Compatible Monochrome Printer

If you want to print from the printer using an existing application and printer driver that were used for a ZPL II compatible monochrome printer, you need to change the printer settings so that they match with the settings of the ZPL II compatible monochrome printer.

Changing from Two-Step Printing to One-Step Printing

CW-C8000 Series allow you to register an image file in png format to the printer, and print data sent from a host computer overlaying the registered image on the print data.

For example, if you had created color labels in two steps as described below, you can change it to one step without changing the system and data on the host computer.

Step 1. Purchasing label paper preprinted in color from a printing company.

Step 2. Printing monochrome data on the preprinted paper using ZPL II compatible monochrome printer.

Conventional Printing Method (Preprinting + Monochrome Printer)

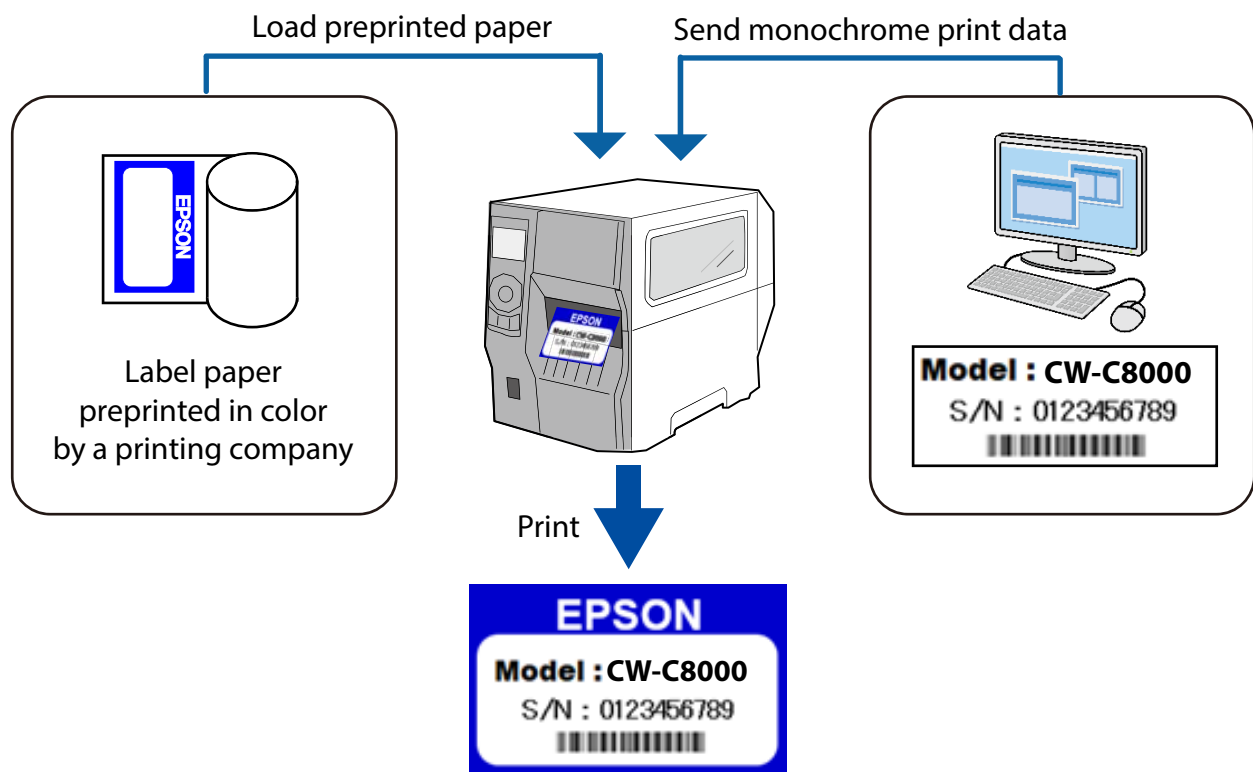

One Step Printing Method with CW-C8000 Series

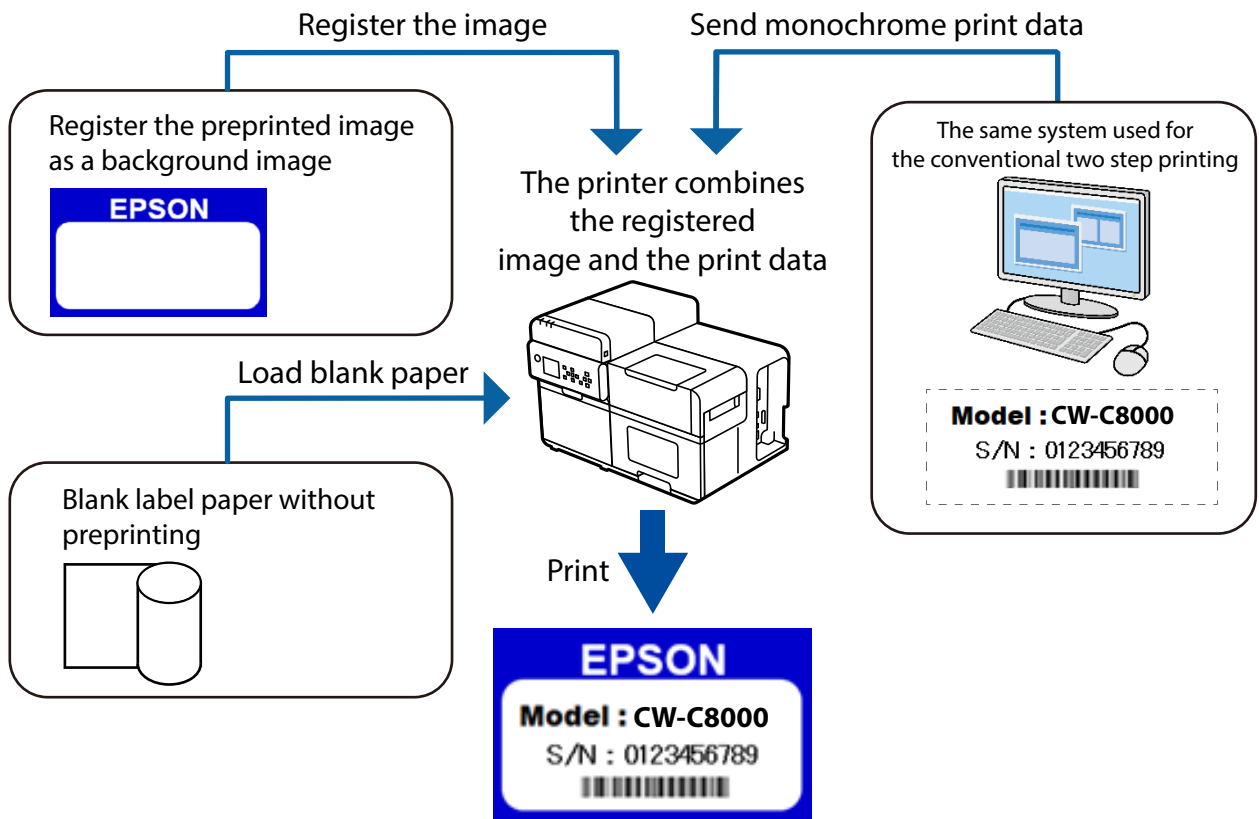

Changing Printer Settings and Replacing Printer

Follow the flowchart below.

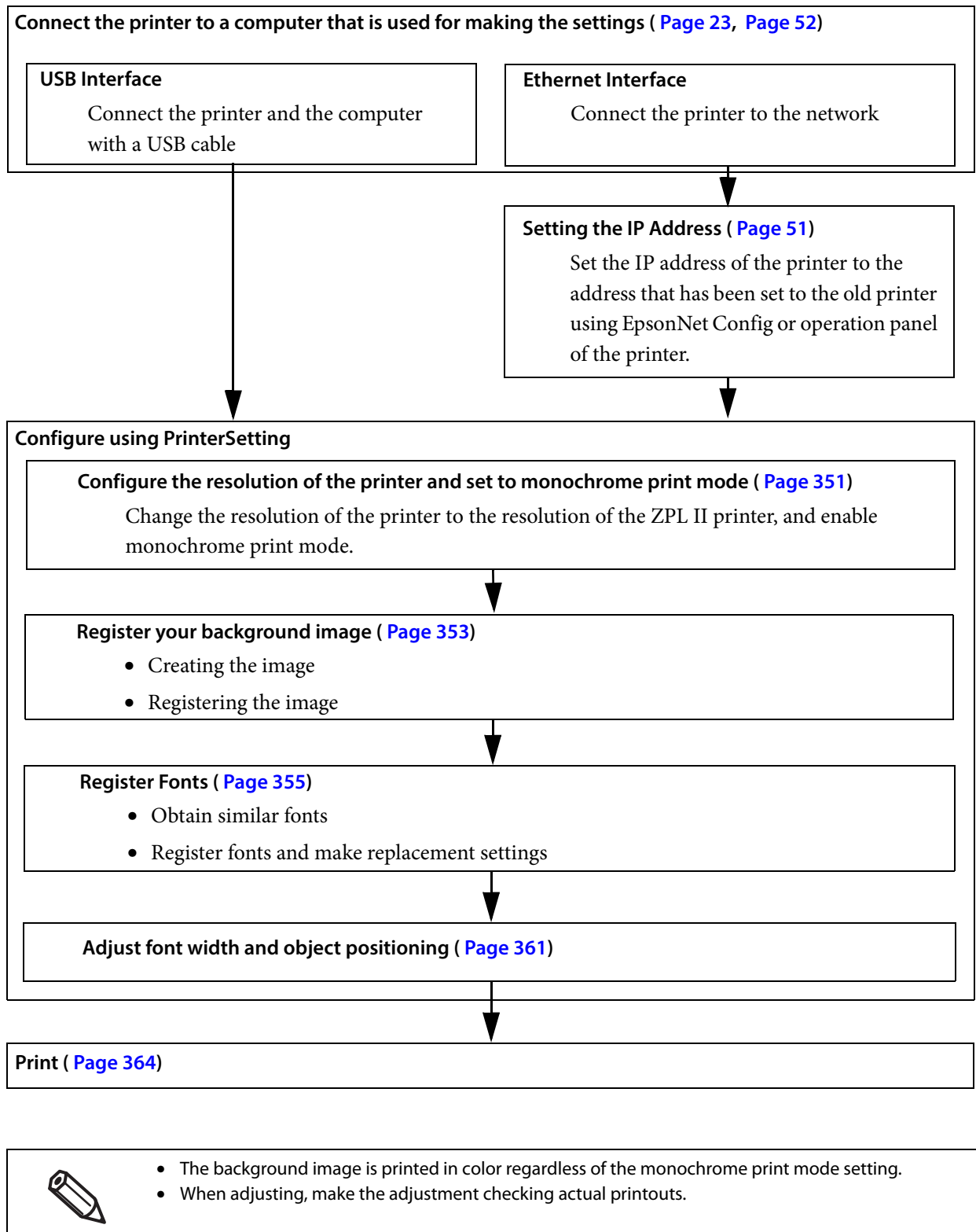

Setting the Printer Resolution and Monochrome Print Mode

- 1 Start PrinterSetting.
- 2 Select [Advanced settings] from the [Detailed settings] menus, then click [Set...] beside the [Replace settings from printer using ZPL II commands] option.

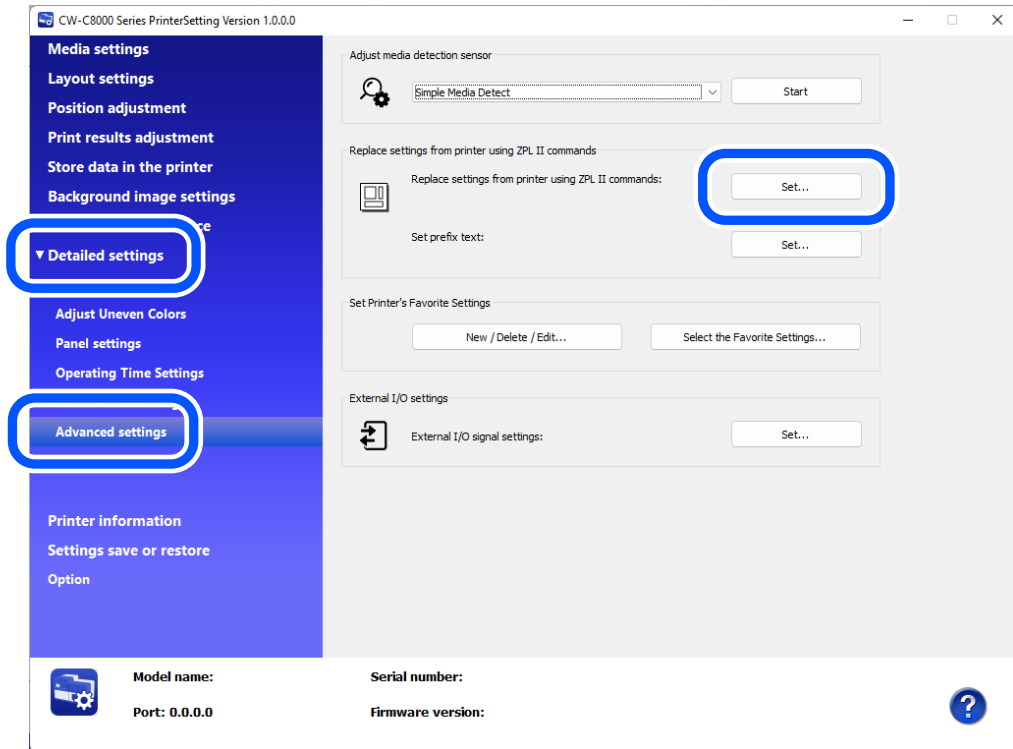

The [Replace settings from printer using ZPL II commands] window appears.

- 3** Select the resolution in the [Resolution of the printer in use] pull-down menu. If the same resolution is not found in the menus, select one of the closest resolution. For example, if the resolution of the ZPL II compatible monochrome printer you were using is 203 dpi, select 200 dpi.

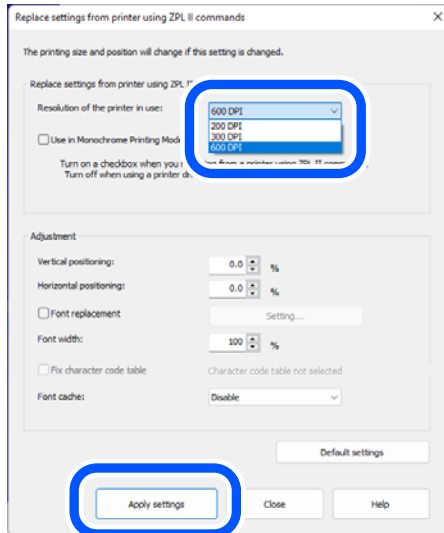

- 4** Select the checkbox for [Use in Monochrome Printing Mode] to print only in black and white and not print in color after replacing from the ZPL II compatible monochrome printer.

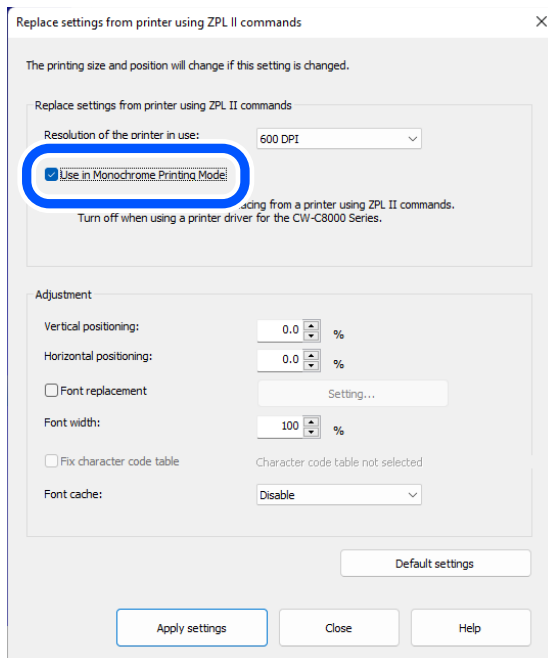

Registering a Background Image

- 1** Create an image to be used as a background image.
Use an image-editing software, save the background image in png format.
Make sure to set the image resolution to 600 dpi.
- 2** Start PrinterSetting.
- 3** On the [Store data in the printer] window, click [Store...] in the [Image (Only .png)] field.
The “Store image” window appears.
- 4** Specify the png image file to be stored, and then click [Set].

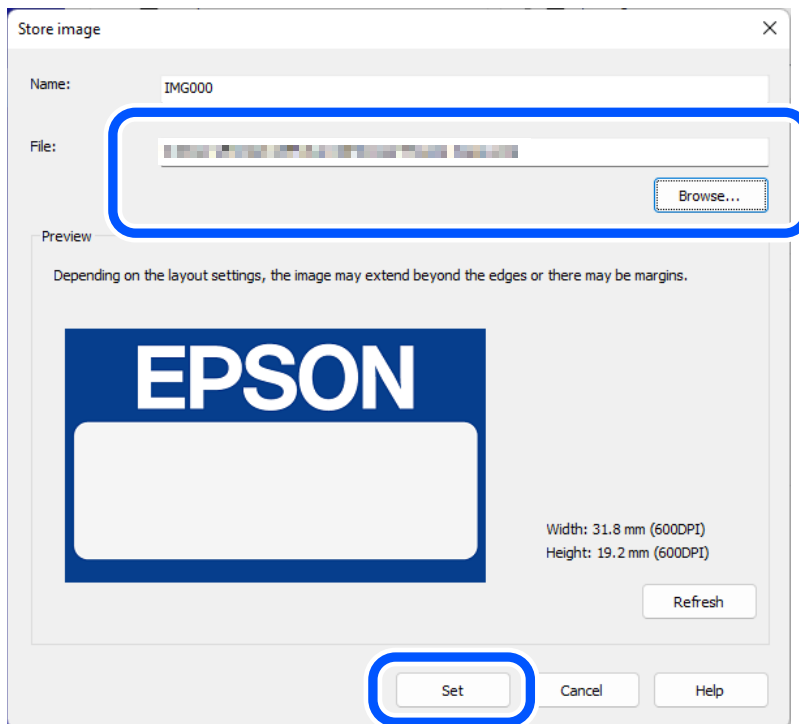

The image file is sent to the printer and stored as a background image.

- 5 On the [Background image settings] window, select the stored image to use in the [Set background image] field.

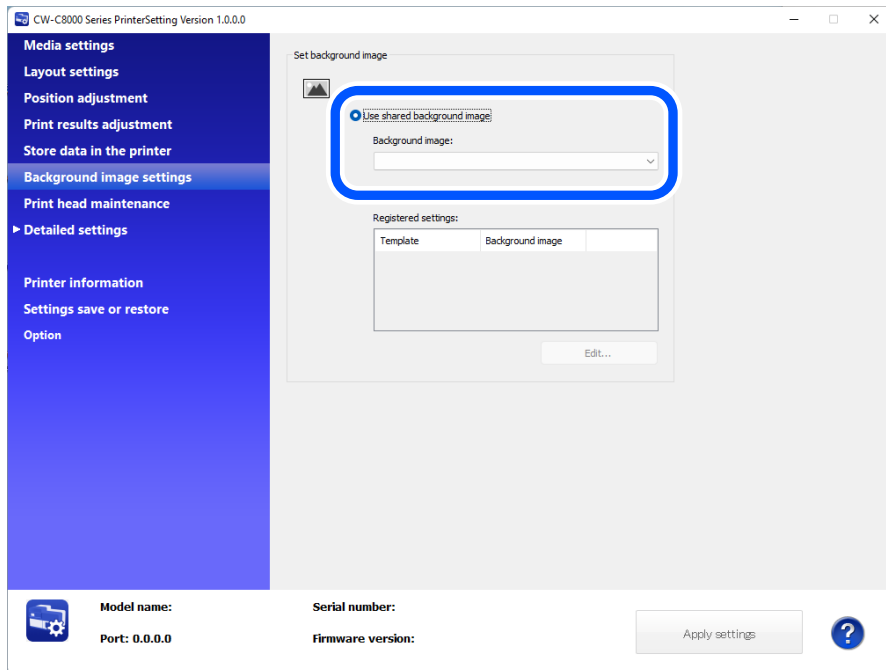

Registering Fonts

Font Registration Function

CW-C8000 Series and ZPL II compatible monochrome printers have built-in fonts. CW-C8000 Series have Epson original built-in fonts and they are different from the fonts on the ZPL II compatible monochrome printers.

Since the font style (shape and thickness) and space around the font (causes changes in character spacing) of printed characters depend on the type of the built-in font, there may be differences in print results between CW-C8000 Series and ZPL II compatible monochrome printers.

Example:

Print results of ZPL II compatible monochrome printer



Print results of CW-C8000 Series



To get print results close to the results of ZPL II compatible monochrome printer, CW-C8000 Series provide the functions to register fonts and replace fonts of the ZPL II printer with similar fonts.

Getting Similar Fonts

Prepare fonts (file format is TTF) similar to the built-in fonts on the ZPL II compatible monochrome printer.

There are the following fonts that are similar to the fonts on ZPL II compatible monochrome printers. Since there are lot of fonts that differ in character thickness and spacing, carefully choose optimum fonts.

Please get fonts and their licenses on your own responsibility.

Similar Fonts (Typical Example)

Font Name	Type Examples
Swiss 721	Black, Black Condensed
Helvetica	Bold, Bold Condensed

Registering/Replacing Fonts

- 1 Start PrinterSetting.
- 2 On the [Store data in the printer] window, click [Store...] in the [Font (Only .ttf and .tte)] field.

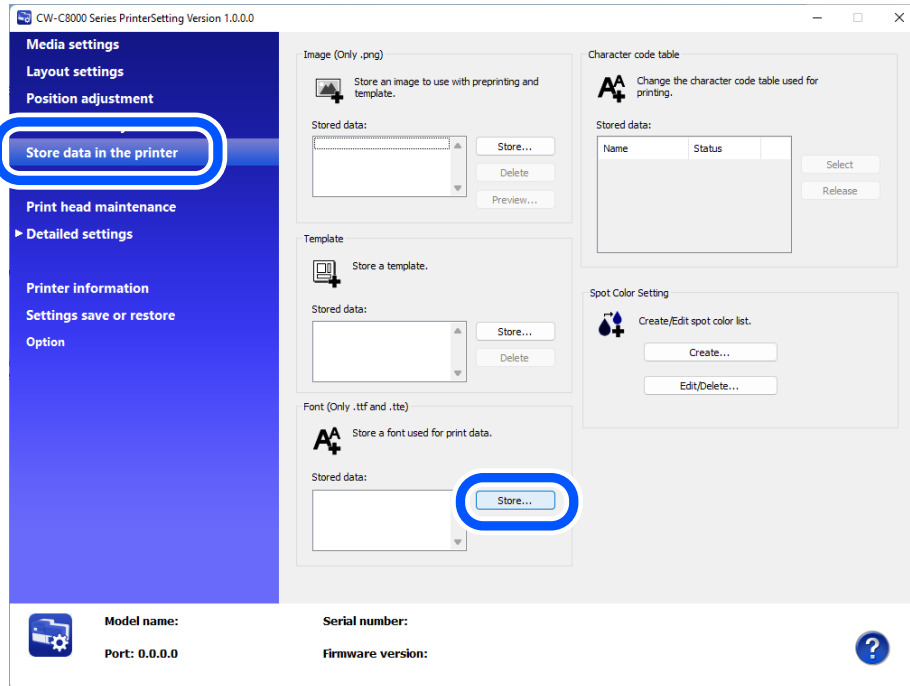

The "Store font" window appears.

- 3 Specify the font file (TTF format) to be stored, and then click [Set].
The font file is sent to the printer and stored as a built-in font.

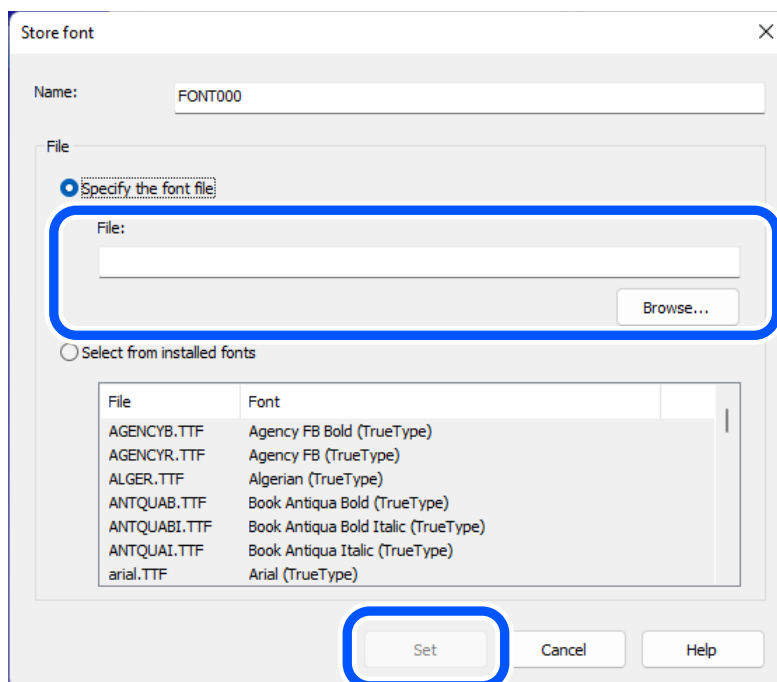

- 4 Select [Advanced settings] from the [Detailed settings] menus, then click [Set...] beside the [Replace settings from printer using ZPL II commands] option.

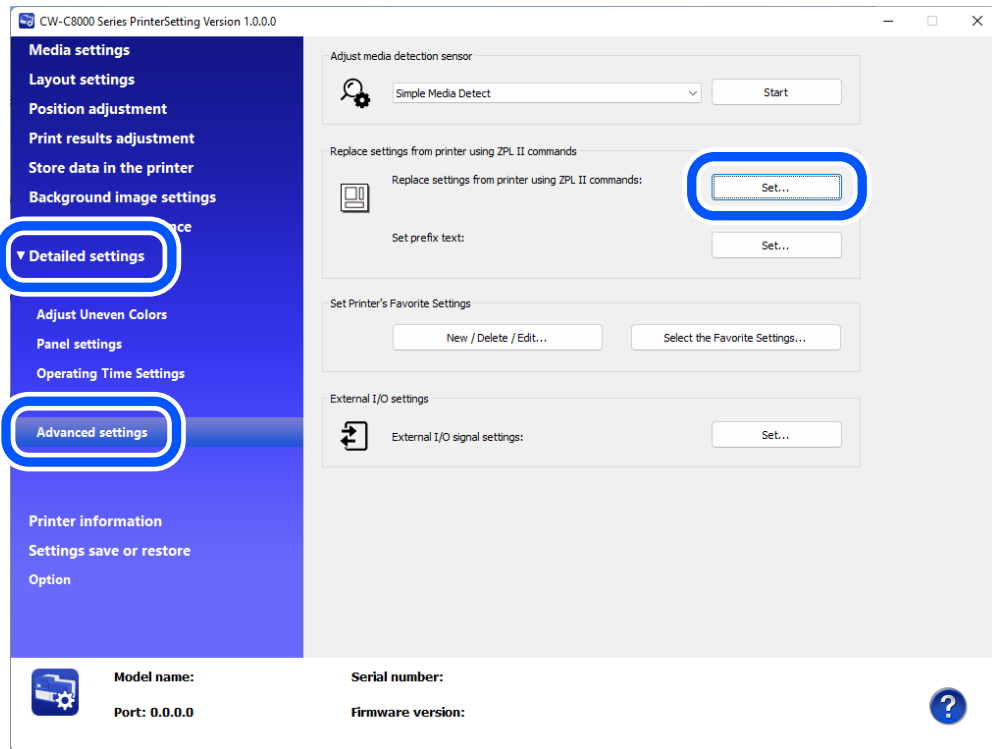

- 5 Select the check box for [Font replacement].

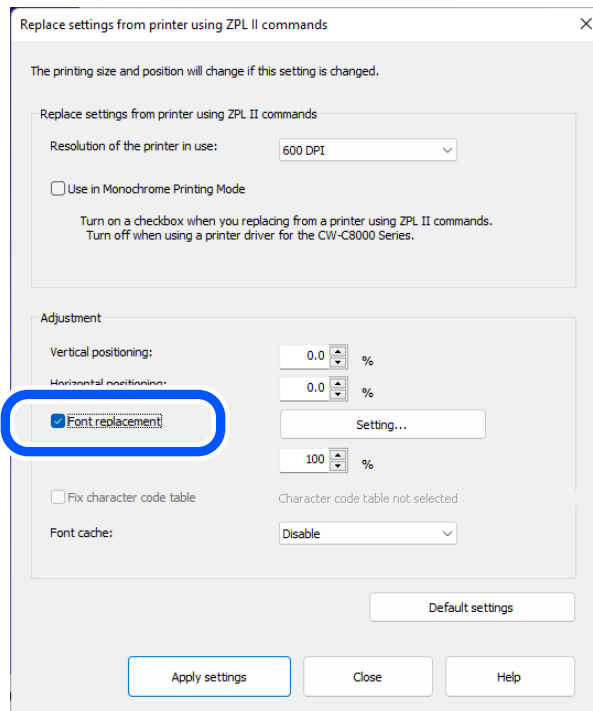

6 Click [Settings].

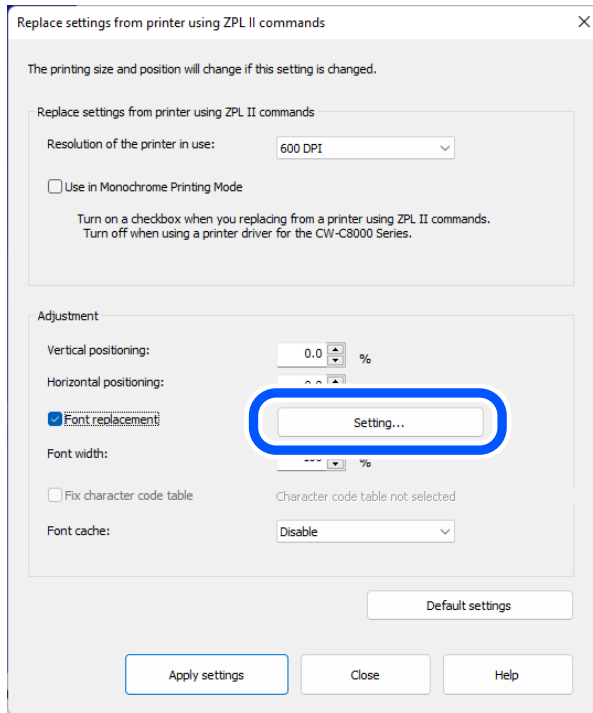

7 Select the font on the ZPL II compatible monochrome printer to be replaced by specifying the ID of the font. Select the ID from the list box.

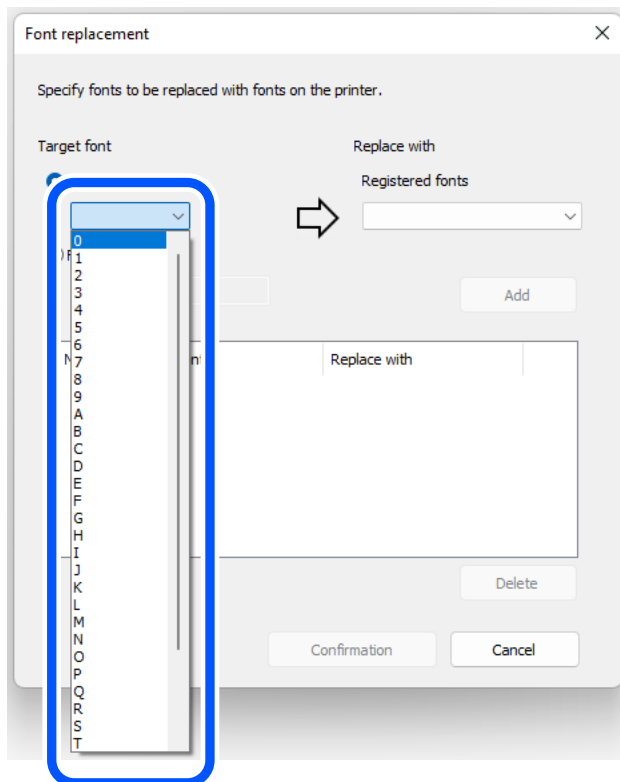

8 Select a font to be associated to the font ID.

Font replacement

Specify fonts to be replaced with fonts on the printer.

Target font

Font ID

0

Replace with

Registered fonts

FONT000.TTF

Add

No.	Target font	Replace with
-----	-------------	--------------

Delete

Confirmation Cancel

9 Click [Add] to add the pair to the list in the window. Click [Confirmation] to save the list and go back to the “Replace settings from printer using ZPL II commands” window.

Font replacement

Specify fonts to be replaced with fonts on the printer.

Target font

Font ID

0

Replace with

Registered fonts

FONT000.TTF

Add

No.	Target font	Replace with
1	0	FONT000.TTF

Delete

Confirmation Cancel

- 10** Click [Apply settings].
The settings are sent and set to the printer.

Adjusting Font Width and Object Positioning

The following adjustments are provided in the [Replace settings from printer using ZPL II commands] window.

Font width

This allows you to reduce width of font. “100%” is the original size. You can specify how much to reduce the width in increments of 1%. If you reduce the width too much, printed characters may become illegible. When you change the setting, check actual printouts. It is expected that the allowable range is 80 to 100%.

Vertical Positioning

This allows you to adjust vertical print position of objects, such as a text, barcode, graphic, and image, on a single page. The setting can be changed in the range of -5.0 to + 5.0% in increments of 0.1%.

Horizontal Positioning

This allows you to adjust horizontal print position of objects, such as a text, barcode, graphic, and image, on a single page. The setting can be changed in the range of -5.0 to + 5.0% in increments of 0.1%.

If the ZPL II compatible monochrome printer used previously was 203 dpi and the CW-C8000 Series prints at 200 dpi, the print result would be 1.5% (203/200) larger. The Vertical positioning and Horizontal positioning functions are used to compensate for this. Note that the positioning functions adjust only position of objects and do not change dimensions of the objects. This is to prevent the objects from being deformed. Especially for a thin line and barcode objects because scaling them down can result in disappearance of the line and drop in readability of the barcode.

In most cases, objects can be properly positioned with this functions, however, if there is a too large object comparing to the page size, or if gaps between multiple objects are too narrow, objects may be printed overlapping with each other resulting in printing labels different from the original label design.

Objects on a page

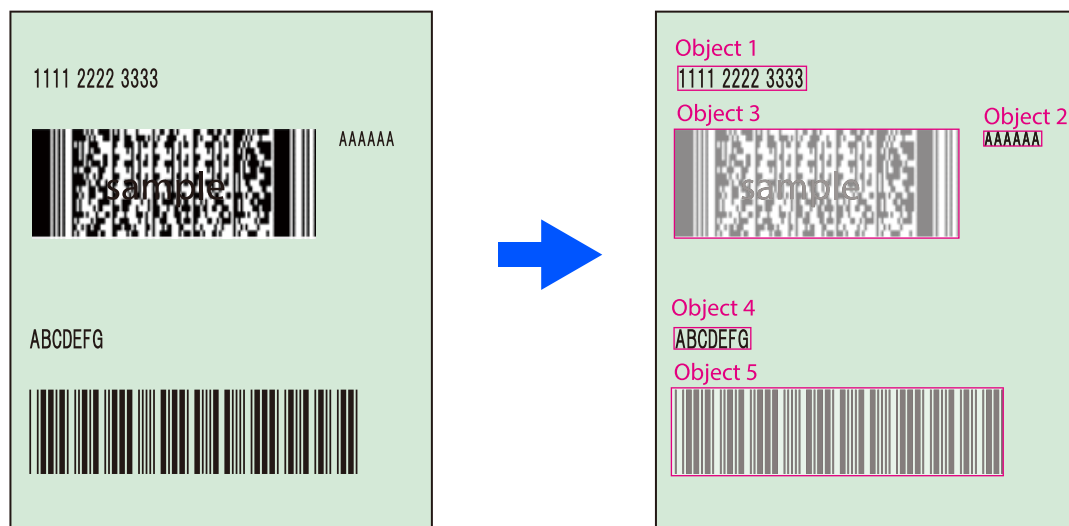

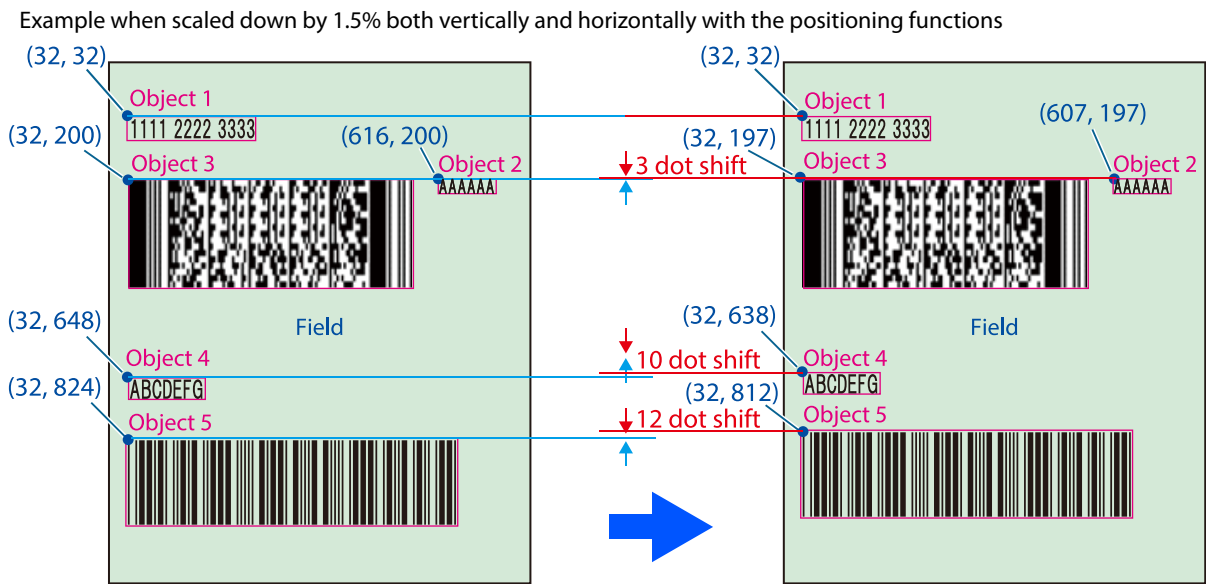

Ex: Object 2: $616 \times 0.985 = 606.8$
 $200 \times 0.985 = 197.0$
 Object 4: $32 \times 0.985 = 31.5$
 $648 \times 0.985 = 638.3$

- 1 Start PrinterSetting.
- 2 Select [Advanced settings] from the [Detailed settings] menus, then click [Set...] beside the [Replace settings from printer using ZPL II commands] option.

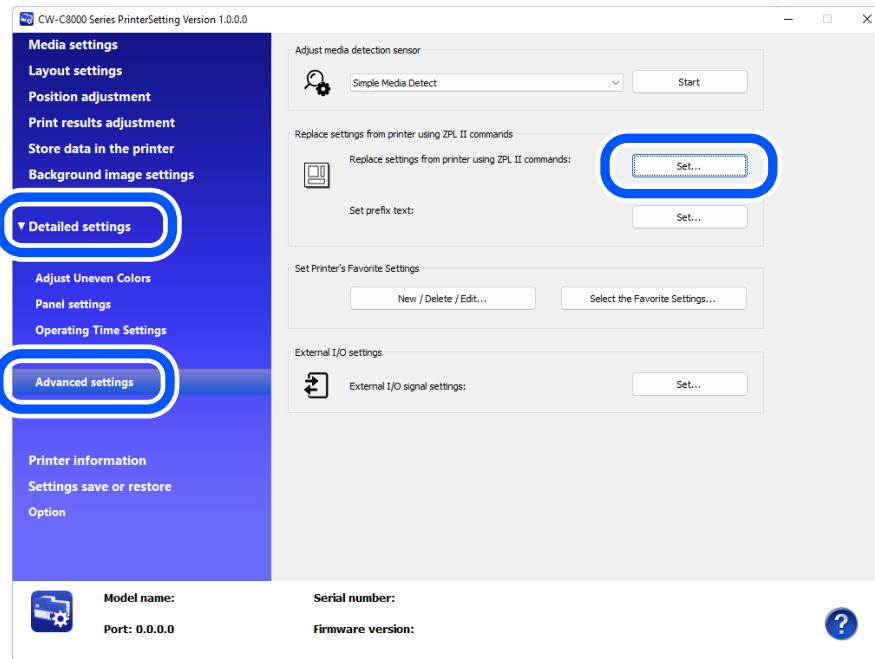

The [Replace settings from printer using ZPL II commands] window appears.

3 Select a value in each of the Vertical positioning and Horizontal positioning boxes.

If you have set the same resolution as the resolution of the ZPL II compatible monochrome printer, set "0" (zero) to both the [Vertical positioning] and [Horizontal positioning].

If the resolution of the ZPL II compatible monochrome printer you were using is 203 dpi, and you have set the resolution to 200 dpi, set "-1.5%" to both the [Vertical positioning] and [Horizontal positioning].

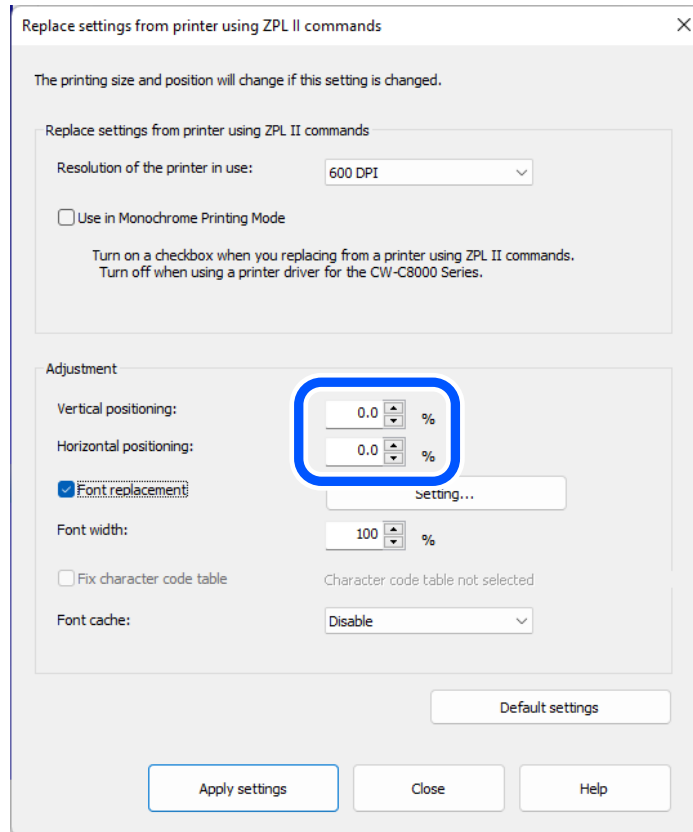

If you do not adjust the font width, proceed to step 5.

4 Adjust the font width.

First set this to “100%”, and then change it after checking actual print results.

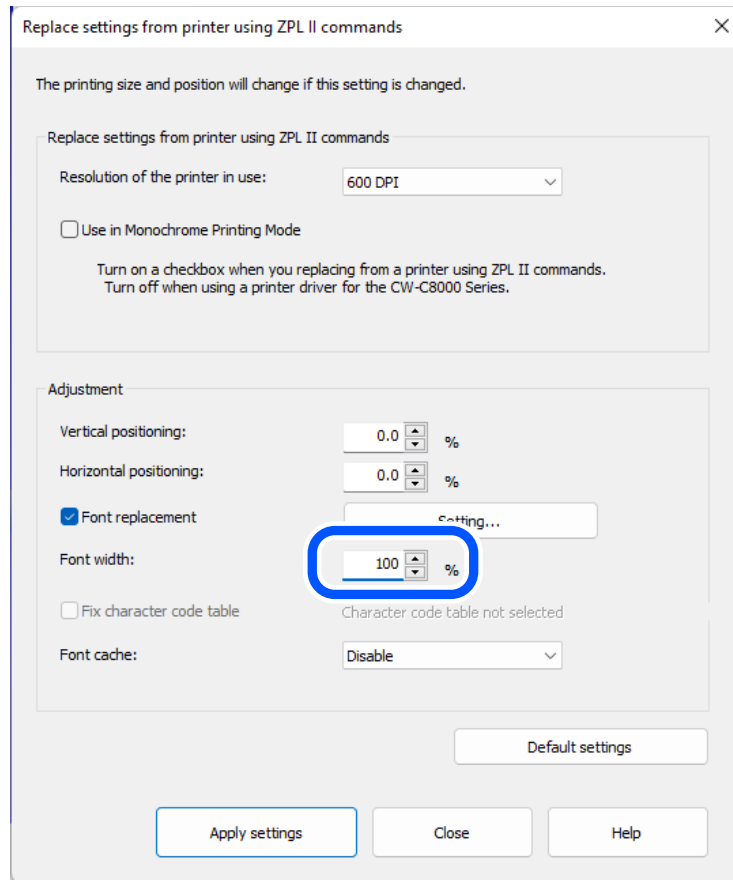

5 Click [Apply settings].

The settings are sent and set to the printer.

Printing

Let the printer print under conditions where the printer is actually used, then check the print results.

Utilizing Templates

If you have used templates with a monochrome thermal printer, you can register the template to CW-C8000 Series and use the templates from your application that directly controls ZPL II commands.

For details, see ["Replacing from ZPL II Compatible Monochrome Printer" on page 348.](#)

Since the ESC/Label commands and ZPL II commands are different in supported range and template file extension, you need to change some commands in accordance with the ESC/Label command specifications. For more details about the ESC/Label command specifications, refer to the "ESC/Label Command Reference Guide".

The procedure is as follows.

1 Register the image. (Page 195)

Register the image to the printer.

2 Register the template. (Page 196)

Register the template to the printer.

If you use template files created by using the ZPL II commands, change the file extension so that the file is supported by the ESC/Label commands. In addition to that, delete commands that are not supported by the ESC/Label commands.

3 Link the template and the image. (Page 200)

Configure the settings to link the template and the image.

4 Set the resolution. (Page 211)

Select [Advanced settings] from the [Detailed settings] menus, then select [Replace settings from printer using ZPL II commands] and set the resolution that is the same as the resolution of the monochrome thermal printer you were using.

5 Print the template.

To print labels using template files, change the file extension of the template file specified by the ZPL II commands in the application so that the file is supported by the ESC/Label commands. The template specified by the ZPL II command in the application, variable information, and the image are combined and printed.

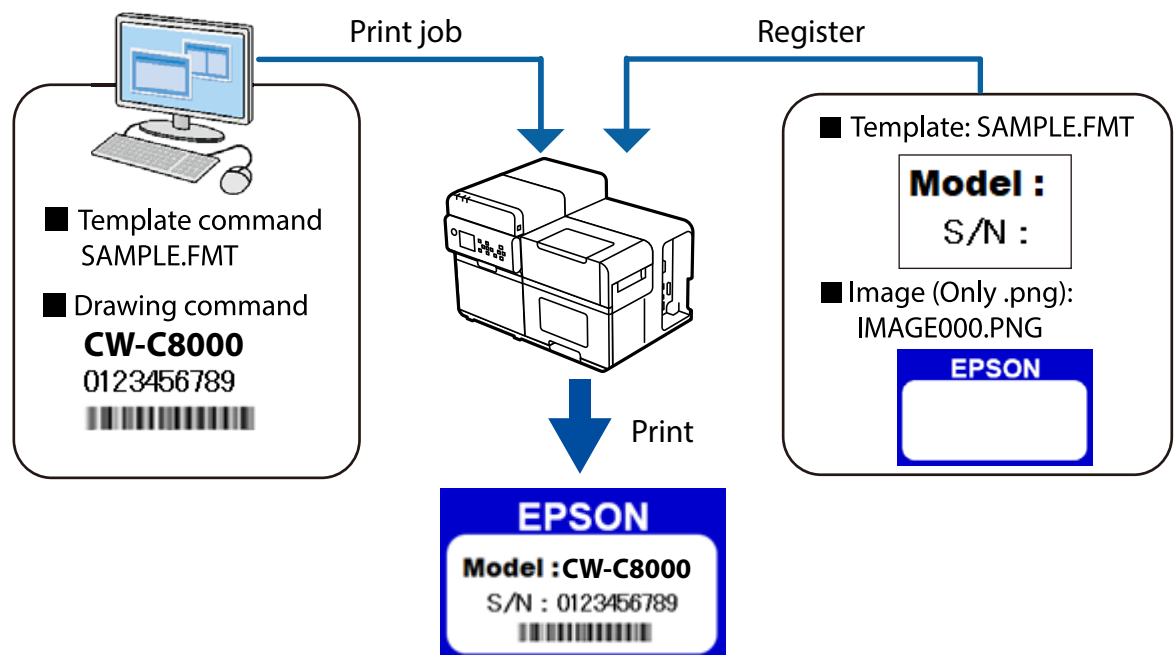

Software and Manuals

The following pieces of software and manuals are provided.

Software

Name	Description	Providing Method
Printer driver for Windows	Driver to print from Windows applications. The utility (CW-C8000 PrinterSetting) for configuring the printer settings can be started from the driver. For details on how to use the driver, refer to Help or the video.	<ul style="list-style-type: none"> • Web
Printer driver for Mac	Driver to print from Mac applications.	<ul style="list-style-type: none"> • Web
Printer driver for Linux	Driver to print from a Linux application.	<ul style="list-style-type: none"> • Dealer
EpsonNet Config SE	Tool to acquire or set network settings, such as TCP/IP of the product.	<ul style="list-style-type: none"> • Web
Color Tone Matching Assistant	Assists you to adjust colors of illustrations or letters. You can check how a specific color used in illustrations or letters will look on printouts.	<ul style="list-style-type: none"> • Web
SAP HVP Plugin	If you use the SAP EH&S WWI HVP system to perform a large amount of printing over the network, the HVP plug-in for EPSON CW-C80x0 can reduce the load on the server and the traffic in the network.	<ul style="list-style-type: none"> • Dealer
Epson Device Admin	Epson Device Admin is multifunctional software that allows you to manage printers on a network. ("Epson Device Admin" on page 242)	<ul style="list-style-type: none"> • Web
USB Printer Class Device Replacement Service	When a USB device of the same model is replaced, this tool automatically changes the output destination to a different printer driver without changing the application or OS settings.	<ul style="list-style-type: none"> • Web

Manual

Name	Description	Providing Method
Start Here	Guides you through basic setup steps from unpacking to loading paper.	<ul style="list-style-type: none"> • Included in the printer package • Web

Name	Description	Providing Method
User's Guide	<p>Describes details about the functions and operating procedures of the product, maintenance information, and troubleshooting. It can be found at the following websites.</p> <p>For customers in North America, go to the following web site: https://www.epson.com/support/</p> <p>For customers in other countries and regions, go to the following web site: https://epson.sn</p>	<ul style="list-style-type: none"> • Web
CW-C8000 Series Technical Reference Guide (This manual)	Provides information necessary for installing the product, performing daily tasks, and developing a system using the product.	<ul style="list-style-type: none"> • Web
Maintenance box manual	Precautions on handling the maintenance box are described.	<ul style="list-style-type: none"> • Included in the maintenance box package • Web
TU-RC8000 Start Here	Precautions on handling the rewinder are described.	<ul style="list-style-type: none"> • Included in the rewinder package • Web
CW-C8000 Series External I/O Technical Reference Guide	Describes information necessary for development regarding extension interfaces.	<ul style="list-style-type: none"> • Web
ESC/Label Command Reference Guide	This manual is common to all models. ESC/Label command specifications are explained.	<ul style="list-style-type: none"> • Web
ESC/Label Command List	List of ESC/Label commands. The available commands and parameters are explained for each model.	<ul style="list-style-type: none"> • Web
ESC/Label Application Development Guide	Explains how to print using the ESC/Label command and how to realize settings and maintenance functions for each model.	<ul style="list-style-type: none"> • Web

Appendix

This chapter describes the specifications of this product.

Product Specifications

Item		Specifications
Printing Method		Line inkjet, dot matrix method Four-color "CMY-K" printing
Paper feed method		Forward and reverse friction feed
Cutting type of the auto cutter		Full cut (cuts paper completely)
Print resolution		600 × 1200 dpi
Print speed		150 mm/s {5.91 in/s} 300 mm/s {11.81 in/s}
Interface	Wired LAN*1	1000BASE-T/100BASE-TX/10BASE-T
	Wireless LAN	Available by connecting the optional Wireless LAN Unit (OT-WL06) to the USB connector
	USB	SuperSpeed USB
Weight		Approx. 35 kg {77.16 lb}

*1: Use a category 5e or higher STP (shielded twisted pair) cable.

Operating Environment

Supported OS	Windows 11 Windows 10 (32 bit/64 bit) Windows 8.1 (32 bit/64 bit) Windows Server 2022 Windows Server 2019 Windows Server 2016 Windows Server 2012 R2 Windows Server 2012 OS X 10.9.5 or later, macOS 10.12 or later
Operation confirmed OS	CentOS 7 (x86_64) Ubuntu 20.04 (x86_64)
Computer	The following computer that runs one of the above operating systems must be supported. PC/AT compatible machine
CPU	A computer that has Pentium 4 2 GHz or higher processor is recommended
Memory	1 GB or more is recommended
HDD	At least 250 MB is required



- The above requirements may not satisfy the minimum system requirements of the supported operating systems. In that case, satisfy the minimum system requirements of the operating system.
- Epson has confirmed the operation of the above OS distributions and versions. Since there are many distributions and versions of Linux, Epson does not guarantee operation of any particular distribution or version. For OS versions and distributions other than those listed above, please check the operation by yourself.

Paper Specifications

The paper that can be used with this printer are as follows.

Use the paper that is supported by the black ink you are using. If you use paper that is not supported by the black ink you are using, ink smear, bleeding, blurring, or faint print may occur.



- If you use paper that does not satisfy the required specifications, it may cause paper jams or lead to a drop of paper feed accuracy, barcode readability, and print quality.
- Depending on temperature and humidity of the place where paper is stored, the paper may be curled. Since degree of shrinkage due to temperature and humidity differs between synthetic labels and backing paper, the paper curling occurs. If you use the curled paper, the paper may be rubbed against the print head causing ink smear on printouts or paper jams.
- Do not use paper sheets connected to each other with pieces of tape or other material. If you use the connected paper, the seams may cause false detection, or the paper may be rubbed against the print head causing ink smear on printouts or paper jams.
- When wrapping paper around the core, it is recommended to use double-sided tape with different adhesive strength on the front and back sides to fasten the paper edge to the core. Stick the strong adhesive side to the core.

This will ensure that the paper roll is properly secured to the core and prevent paper feeding errors. If the edge of roll paper is glued directly to the core, the printer cannot detect a paper end status and multiple unprinted labels remain on the roll paper when the paper runs out.

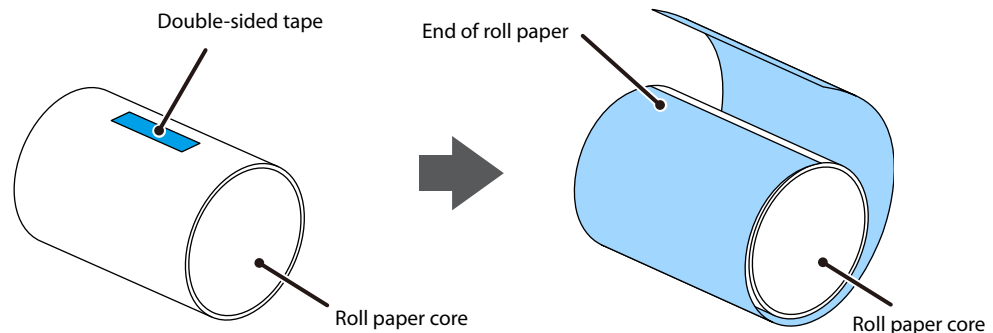

Decide the position and length of the double-sided tape to be applied so that the following conditions are met.

(Recommended tape: Double-sided tape to be used at the beginning of the roll paper)

Adhesive strength between roll paper backing paper and double-sided tape: 1 ± 0.3 N

Adhesive strength between the surface of the core and the double-sided tape: 2 N or more

Paper Form

Paper Form	Page
Roll continuous paper	Page 372
Roll continuous paper (Black Mark)	Page 372
Fanfold continuous paper (Black Mark)	Page 373
Roll full-page label	Page 374
Roll full-page label (Black Mark)	Page 374
Roll die-cut label (Gap)	Page 375
Roll die-cut label (Black Mark)	Page 375

Paper Form	Page
Fanfold die-cut label (Black Mark)	Page 377
Roll tag (Hole, Oblong Hole, Cutout)	Page 379
Fanfold tag (Hole, Oblong Hole, Cutout)	Page 380

Paper Type

Paper Type	When using Matte Ink	When using Gloss Ink
Plain Paper	✓	-
Matte Paper	✓	✓
Texture Paper	✓	-
Synthetic	✓	✓
Glossy Paper	-	✓
Glossy Film	-	✓
High Glossy Paper	-	✓



- If you use paper that does not satisfy the required specifications, it may cause paper jams or lead to a drop of paper feed accuracy, barcode readability, and print quality.
- If the end edge of roll paper is pasted or taped to the core, the printer will fail to detect the end of the paper resulting in wasting multiple labels on the roll paper.
- If you are using synthetic labels with backing sheet made of paper, or labels with polyethylene laminated backing sheet, paper curl may occur depending on storage and usage environmental conditions. Because the degree of expansion and contraction due to heat and moisture varies between the plastic materials, such as the synthetic and polyethylene, and the paper materials. If you use the curled paper, the paper may be rubbed against the print head causing ink smear on printouts or paper jams.
- Do not use paper sheets connected to each other with pieces of tape or other material. If you use the connected paper, the seams may cause false detection, or the paper may be rubbed against the print head causing ink smear on printouts or paper jams.
- When using matte black ink, if you touch paper surface immediately after printing, ink may adhere to your fingers.
- If labels less than 25.4 mm {1.00 in.} in length are automatically cut, they may stay near the fixed blade and be difficult to remove.
- The printer may not be able to detect the paper correctly depending on the paper material and the condition of the black marks. Please verify the paper well before using it.
- Backfeeding paper less than 50.8 mm {2 in.} wide may degrade print quality.
- Print quality may be degraded when the [Media Source] is set to [Rear Feed] and the rewinder is used.

Paper Shape/Form/Size

Roll Continuous Paper / Roll Continuous Paper (Black Mark)

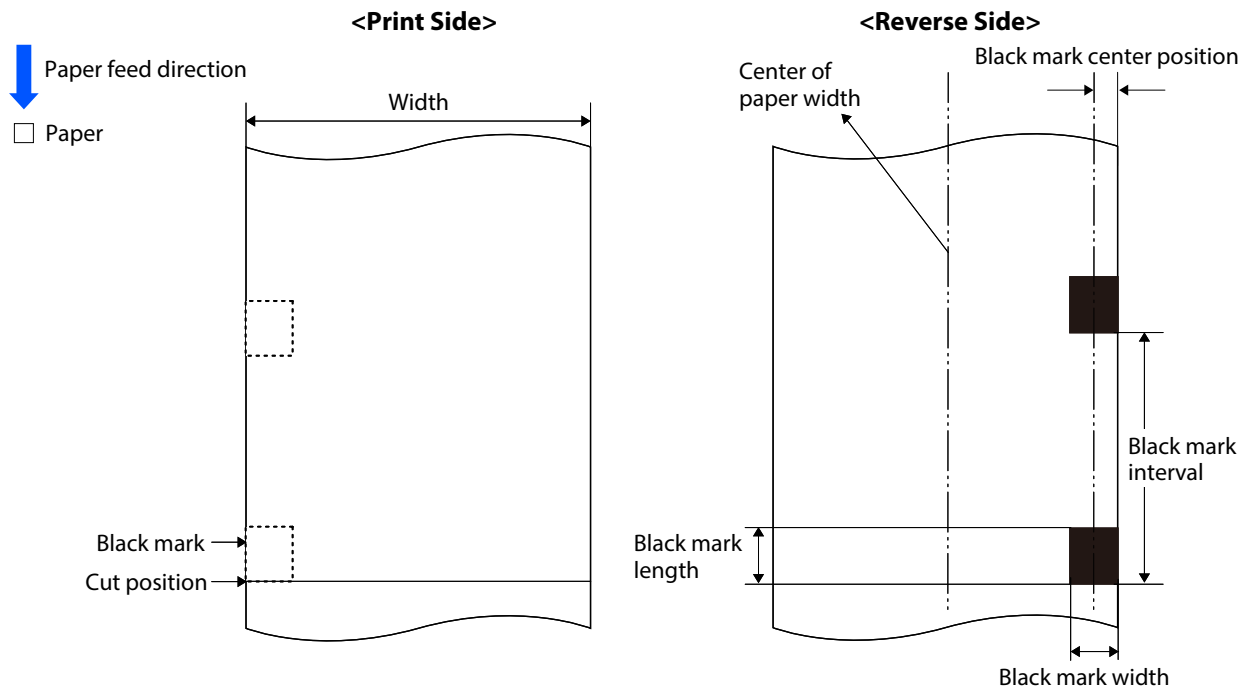

Item	Specifications	
	Continuous Paper	Continuous Paper (Black Mark)
Paper Type	Plain paper, Matte paper, Glossy paper	
Paper width	25.4 to 112 mm {1.00 to 4.41 in.} (Internal) 50 to 112 mm {1.97 to 4.41 in.} (Rear Feed)	
Black mark position	-	See the above figure
Black mark width	-	19 mm {0.75 in.} or more
Black mark length	-	4 to 25.4 mm {0.16 to 1.00 in.}, with 4 mm {0.16 in.} or more of space around the mark
Black mark center position	-	12.4 mm {0.49 in.}
Black mark interval	-	11 to 1016 mm {0.43 to 40.00 in.} Auto cut is not possible when the length of the paper is less than 15 mm {0.59 in.}.
Paper thickness	0.084 to 0.131 mm {0.003 to 0.005 in.}	
Roll paper core inner diameter	76.2 ± 0.5 mm {3.00 ± 0.02 in.}	
Roll core outer diameter	82.2 mm {3.24 in.} or more	
Roll paper outer diameter	Up to 203.2 mm {8.00 in.}	
Winding direction	The side to be printed must face outward	
Holes and cutouts	Paper with holes or cutouts cannot be used	



Since the black mark detector is not located at the center position of the paper width, if there are black marks on both sides of the paper, black marks will be detected no matter which side of the paper you print from.

Fanfold Continuous Paper (Black Mark)

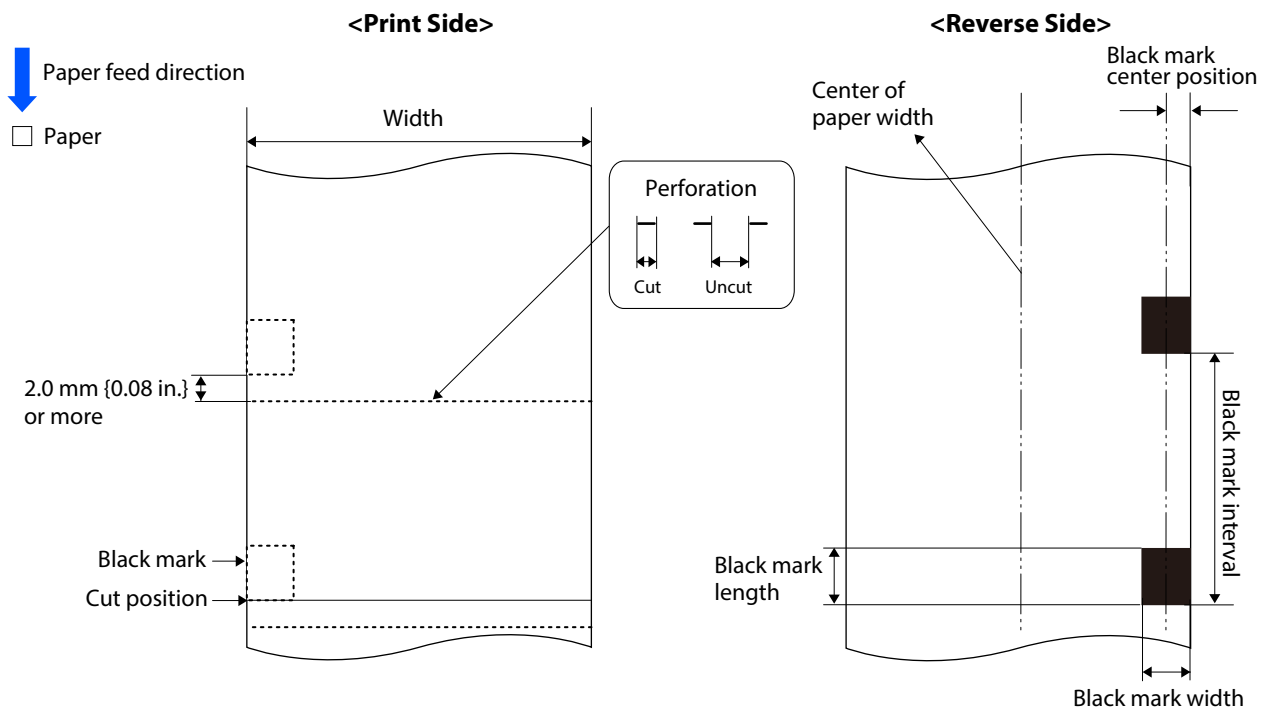

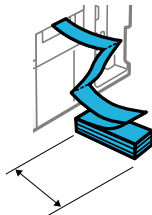
Item	Specifications
Paper Type	Plain paper, Matte paper, Glossy paper
Paper width	50 to 112 mm {1.97 to 4.41 in.}
Black mark position	See the above figure. At least 2.0 mm {0.08 in.} away from the perforation
Black mark width	19 mm {0.75 in.} or more
Black mark length	4 to 25.4 mm {0.16 to 1.00 in.}, with 4 mm {0.16 in.} or more of space around the mark
Black mark center position	12.4 mm {0.49 in.}
Black mark interval	11 to 304.8 mm {0.43 to 12.00 in.} Auto cut is not possible when the length of the paper is less than 15 mm {0.59 in.}
Paper thickness	0.084 to 0.131 mm {0.003 to 0.005 in.}
Fold interval	 152.4 to 304.8 mm {6.00 to 12.00 in.}
Number of folds	750 or less
Perforation form	3 to 5 mm {0.12 to 0.20 in.} of slit length with 1 mm {0.04 in.} interval * There should be no slits at both side edges of paper
Holes and cutouts	Paper with holes or cutouts cannot be used

- 
- Auto cutting on the perforation lines will generate scraps of paper that may cause problems. Also, auto cutting ahead of the perforation line may cause problems when feeding paper. Therefore, perform auto cutting when paper is fed at least 0.5 to 1 mm {0.02 to 0.04 in.} away from the perforation line.
 - Since the black mark detector is not located at the center position of the paper width, if there are black marks on both sides of the paper, black marks will be detected no matter which side of the paper you print from.

Roll Full-page Label/ Roll Full-page Label (Black Mark)

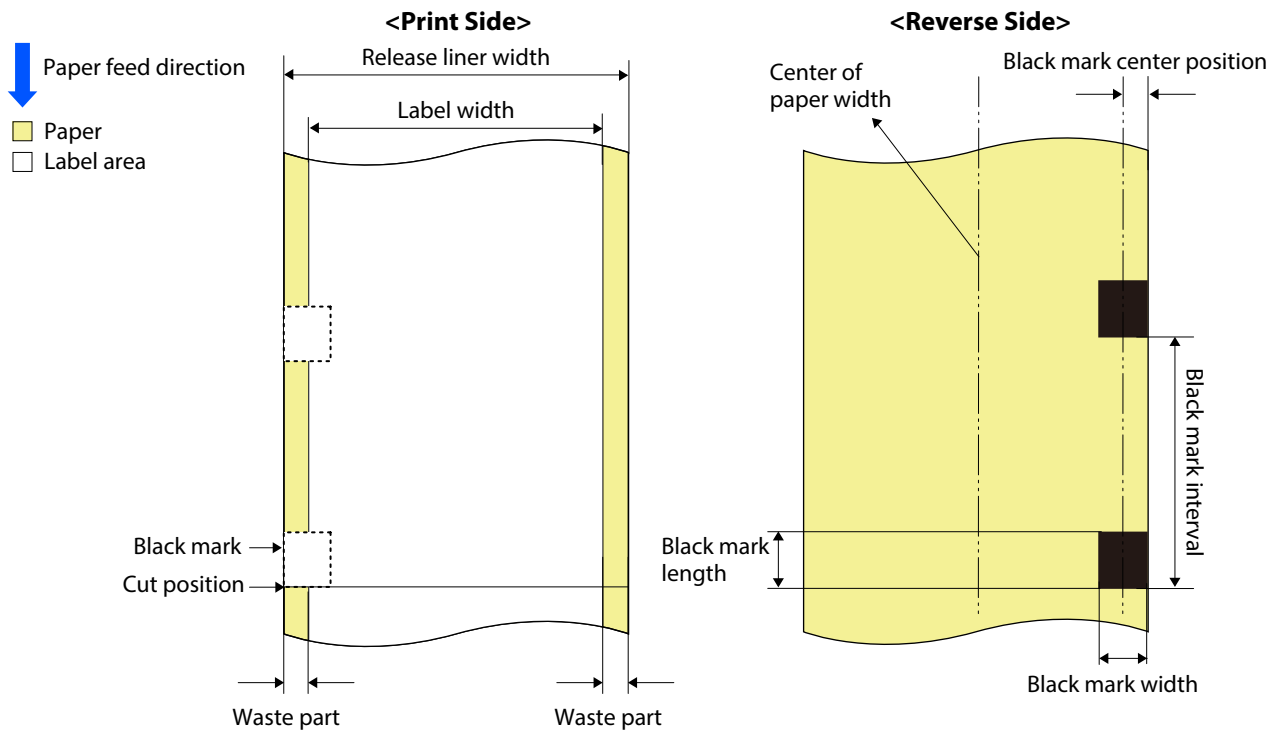

Item	Specifications	
	Without black marks	With black marks
Paper Type	Plain paper, Matte paper, Synthetic paper, Glossy paper, Glossy film, High glossy paper, Texture paper	
Release liner width	25.4 to 112 mm {1.00 to 4.41 in.} (Internal) 50 to 112 mm {1.97 to 4.41 in.} (Rear Feed)	
Label width	21.4 to 108 mm {0.84 to 4.25 in.} (Internal) 46 to 108 mm {1.81 to 4.25 in.} (Rear Feed)	
Waste part on both sides	2 ± 0.5 mm {0.08 ± 0.02 in.}	
Black mark position	-	See the above figure
Black mark width	-	19 mm {0.75 in.} or more
Black mark length	-	4 to 25.4 mm {0.16 to 1.00 in.}, with 4 mm {0.16 in.} or more of space around the mark
Black mark center position	-	12.4 mm {0.49 in.}
Black mark interval	-	11 to 1016 mm {0.43 to 40.00 in.} Auto cut is not possible when the length of the paper is less than 15 mm {0.59 in.}
Paper thickness	0.159 to 0.240 mm {0.006 to 0.009 in.}	
Roll paper core inner diameter	76.2 ± 0.5 mm {3.00 ± 0.02 in.}	
Roll core outer diameter	82.2 mm {3.24 in.} or more	
Roll paper outer diameter	Up to 203.2 mm {8.00 in.}	
Winding direction	The side to be printed must face outward	
Holes and cutouts	Paper with holes or cutouts cannot be used	



- To prevent adhesive from adhering to the roll paper supply unit, use label paper from which the left and right wasted parts are removed.
- Since the black mark detector is not located at the center position of the paper width, if there are black marks on both sides of the paper, black marks will be detected no matter which side of the paper you print from.

Roll Die-cut Label (Gap/Black Mark)

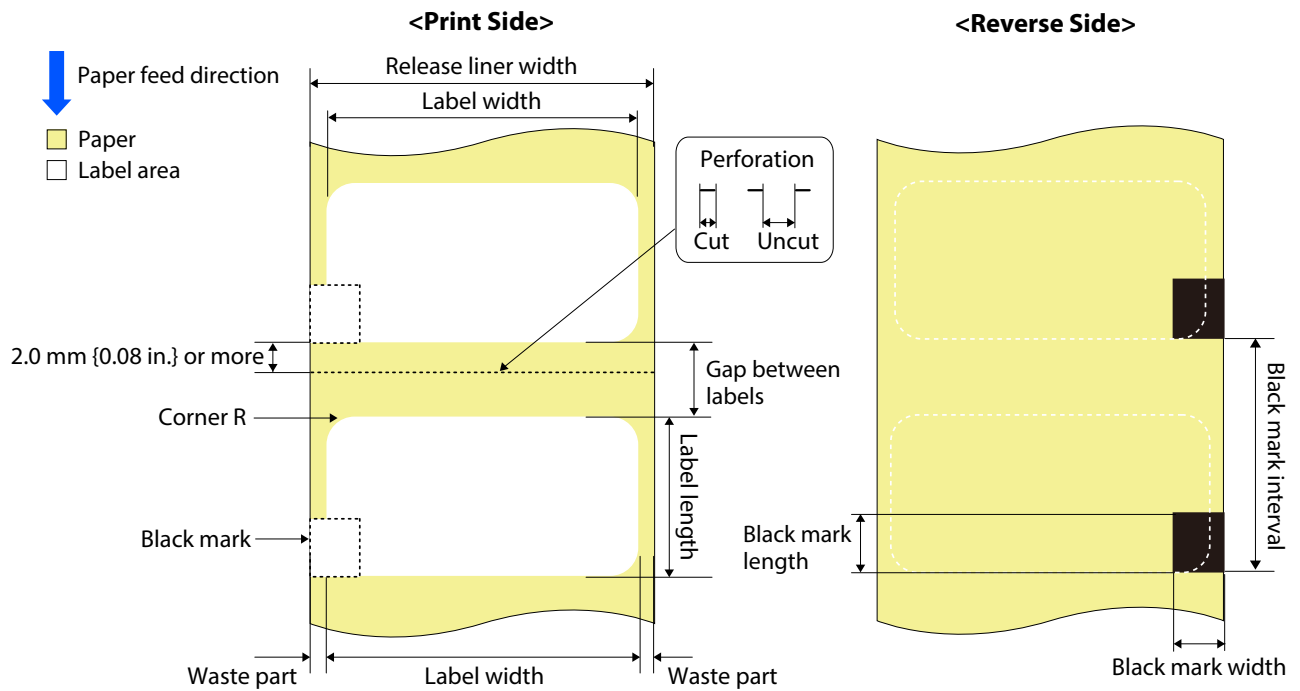

Item	Specifications	
	Die-cut label (Gap)	Die-cut label (Black Mark)
Paper Type	Plain paper, Matte paper, Synthetic paper, Glossy paper, Glossy film, High glossy paper, Texture paper	
Release liner width	25.4 to 112 mm {1.00 to 4.41 in.} (Internal) 50 to 112 mm {1.97 to 4.41 in.} (Rear Feed)	
Label width	21.4 to 108 mm {0.84 to 4.25 in.} (Internal) 46 to 108 mm {1.81 to 4.25 in.} (Rear Feed)	
Label length	8 to 1016 mm {0.31 to 40.00 in.} Auto cut is not possible when the length of the paper is less than 15 mm {0.59 in.}.	
Gap between labels	3 to 6 mm {0.12 to 0.24 in.}	
Waste part on both sides	2 ± 0.5 mm {0.08 ± 0.02 in.}	
Label corner R	1.5 mm {0.06 in.}	
Black mark position	-	See the above figure. Leading edge of the mark should be aligned with that of the label
Black mark width	-	19 mm {0.75 in.} or more
Black mark length	-	4 to 25.4 mm {0.16 to 1.00 in.}, with 4 mm {0.16 in.} or more of space around the mark
Black mark interval	-	11 to 1016 mm {0.43 to 40.00 in.} (When auto cutting is not performed) 18 to 1016 mm {0.71 to 40.00 in.} (When auto cutting is performed)
Paper thickness	0.159 to 0.240 mm {0.006 to 0.009 in.}	
Roll paper core inner diameter	76.2 ± 0.5 mm {3.00 ± 0.02 in.}	
Roll core outer diameter	82.2 mm {3.24 in.} or more	
Roll paper outer diameter	Up to 203.2 mm {8.00 in.}	
Winding direction	The side to be printed must face outward	
Perforation form	3 to 5 mm {0.12 to 0.20 in.} of slit length with 1 mm {0.04 in.} interval * There should be no slits at both side edges of paper	
Holes and cutouts	Paper with holes or cutouts cannot be used	



- Auto cutting on the perforation lines will generate scraps of paper that may cause problems. Also, auto cutting ahead of the perforation line may cause problems when feeding paper. Therefore, perform auto cutting when paper is fed at least 0.5 to 1 mm {0.02 to 0.04 in.} away from the perforation line.
- Place the black mark at least 2 mm {0.08 in.} away from the perforation. (Only for paper with black marks)
- For synthetic paper labels with transparent backing, use the gap detection setting since paper detection with black marks is not possible. (Only for paper with black marks)
- If the backing paper is synthetic paper or film, it may be difficult to separate by hand even if perforated, so do not use perforations in such cases. (Only for gap detection)
- Set the cut position to a position at least 1.5 mm {0.06 in.} away from the black mark of the next label. (Only for paper with black marks)
- Set the cut position to a position at least 0.7 mm {0.03 in.} away from the leading edge of the next label. (Only for gap detection)
- Do not use paper with gap between labels outside the printer's specification range, as paper jams may occur.
- Since the black mark detector is not located at the center position of the paper width, if there are black marks on both sides of the paper, black marks will be detected no matter which side of the paper you print from.
- Depending on the shape, thickness, and hardness of the die-cut label, the label may peel off from the backing paper inside the printer. If you want to use die-cut labels that do not meet the specifications of the printer, please contact your dealer in advance.

Fanfold Die-cut Label (Black Mark)

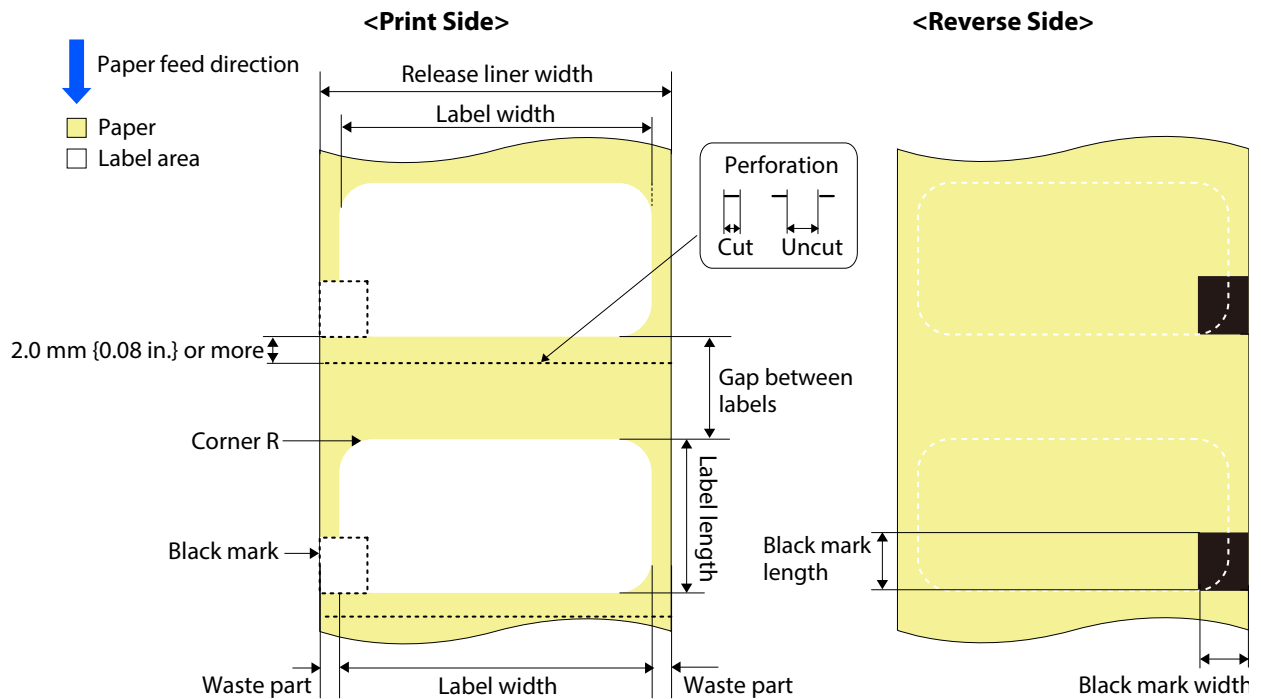

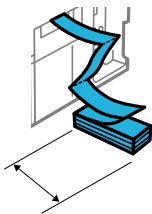

Item	Specifications
Paper Type	Plain paper, Matte paper, Synthetic paper, Glossy paper, Glossy film, High glossy paper, Texture paper
Release liner width	50 to 112 mm {1.97 to 4.41 in.}
Label width	46 to 108 mm {1.81 to 4.25 in.}
Label length	8 to 301.8 mm {0.31 to 11.88 in.} Auto cut is not possible when the length of the paper is less than 15 mm {0.59 in.}
Gap between labels	3 to 6 mm {0.12 to 0.24 in.}
Waste part on both sides	2 ± 0.5 mm {0.08 ± 0.02 in.}
Label corner R	1.5 mm {0.06 in.}
Black mark position	See the above figure. Leading edge of the mark should be aligned with that of the label
Black mark width	19 mm {0.75 in.} or more
Black mark length	4 to 25.4 mm {0.16 to 1.00 in.}, with 4 mm {0.16 in.} or more of space around the mark
Black mark interval	11 to 304.8 mm {0.43 to 12.00 in.} (When auto cutting is not performed) 18 to 304.8 mm {0.71 to 12.00 in.} (When auto cutting is performed)
Paper thickness	0.159 to 0.240 mm {0.006 to 0.009 in.}
Fold interval 	152.4 to 304.8 mm {6.00 to 12.00 in.}
Number of folds	750 or less
Perforation form	3 to 5 mm {0.12 to 0.20 in.} of slit length with 1 mm {0.04 in.} interval * There should be no slits at both side edges of paper
Holes and cutouts	Paper with holes or cutouts cannot be used



- Auto cutting on the perforation lines will generate scraps of paper that may cause problems. Also, auto cutting ahead of the perforation line may cause problems when feeding paper. Therefore, perform auto cutting when paper is fed at least 0.5 to 1 mm {0.02 to 0.04 in.} away from the perforation line.
- Place the black mark at least 2 mm {0.08 in.} away from the perforation.
- Paper with film backing cannot be used.
- Set the cut position to a position at least 1.5 mm {0.06 in.} away from the black mark of the next label.
- Do not use paper with gap between labels outside the printer's specification range, as paper jams may occur.
- Since the black mark detector is not located at the center position of the paper width, if there are black marks on both sides of the paper, black marks will be detected no matter which side of the paper you print from.
- Depending on the shape, thickness, and hardness of the die-cut label, the label may peel off from the backing paper inside the printer. If you want to use die-cut labels that do not meet the specifications of the printer, please contact your dealer in advance.

Roll Tag (Hole, Oblong Hole, Cutout)

 Paper feed direction  Holes, oblong holes, and cutouts for paper detection
 Paper

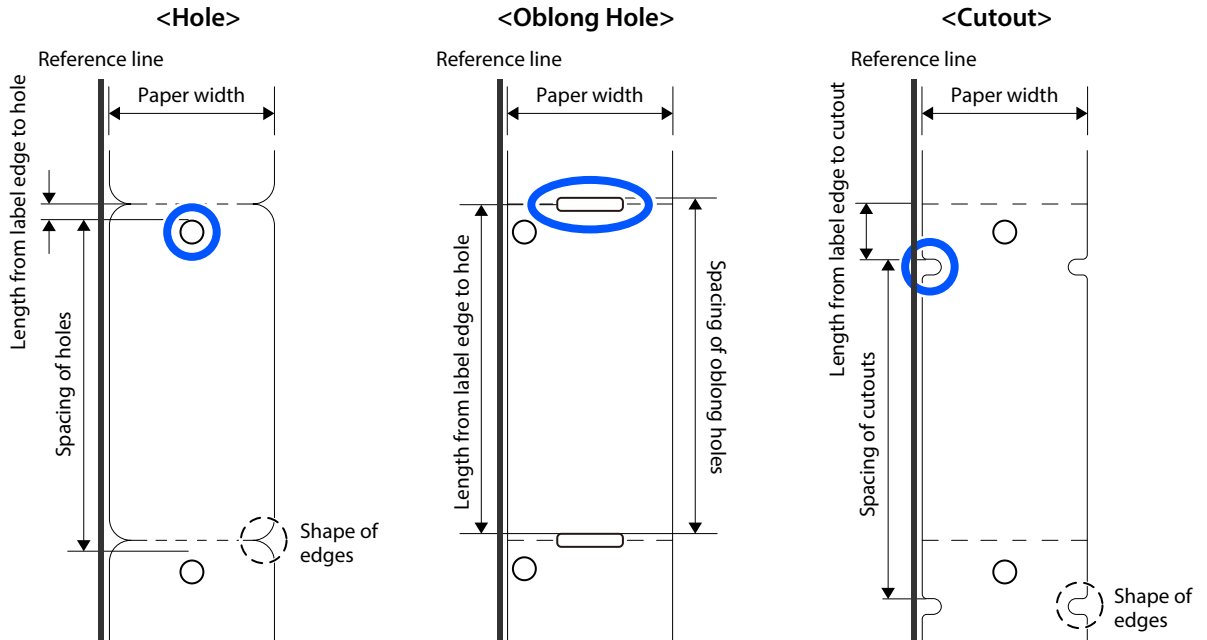



Item	Specifications
Paper Type	Plain paper, Matte paper, Glossy paper
Paper width	25.4 to 112 mm {1.00 to 4.41 in.} (Internal) 50 to 112 mm {1.97 to 4.41 in.} (Rear Feed)
Paper thickness	Up to 0.6 mm {0.24 in.}
Roll paper core inner diameter	76.2 ± 0.5 mm {3.00 ± 0.02 in.}
Roll core outer diameter	82.2 mm {3.24 in.} or more
Roll paper outer diameter	Up to 203.2 mm {8.00 in.}
Winding direction	The side to be printed must face outward
Spacing of holes for paper detection (holes, oblong holes and cutouts)	11 to 306 mm {0.43 to 12.05 in.}
Paper detection method	Holes, oblong holes, or cutouts for paper detection
Length from label edge to hole/cutout	0 to 306 mm {0.00 to 12.05 in.} (distance from print start position to top of hole)
Dimensions of hole for paper detection (holes, oblong holes and cutouts)	Allowable hole dimensions depend on how far away the hole is from the paper's reference line. However, the allowable dimensions of cutouts do not vary depending on the distance from the paper's reference line.  "Allowable Tag Holes Dimensions by Distance from Paper Reference Line" on page 381
Shape of tag edges	R (round chamfering) 1.5 mm {0.06 in.} or less C (chamfering) 1.5 mm {0.06 in.} or less



- If the paper is thicker than 0.2 mm {0.008 in.}, the paper may rub against the print head due to curling caused by the roll core. In this case, increase the diameter of the core and check if printing can be done normally.
- When paper cannot be used because its holes, oblong holes, or cutouts for paper detection are not detected, it may be possible to use the paper by adjusting the sensitivity of the sensor or the threshold for label detection.
 ["Adjusting Detectors Sensitivity and Label Detection Thresholds" on page 293](#)

Fanfold Tag (Hole, Oblong Hole, Cutout)

 Paper feed direction  Holes, oblong holes, and cutouts for paper detection

Paper

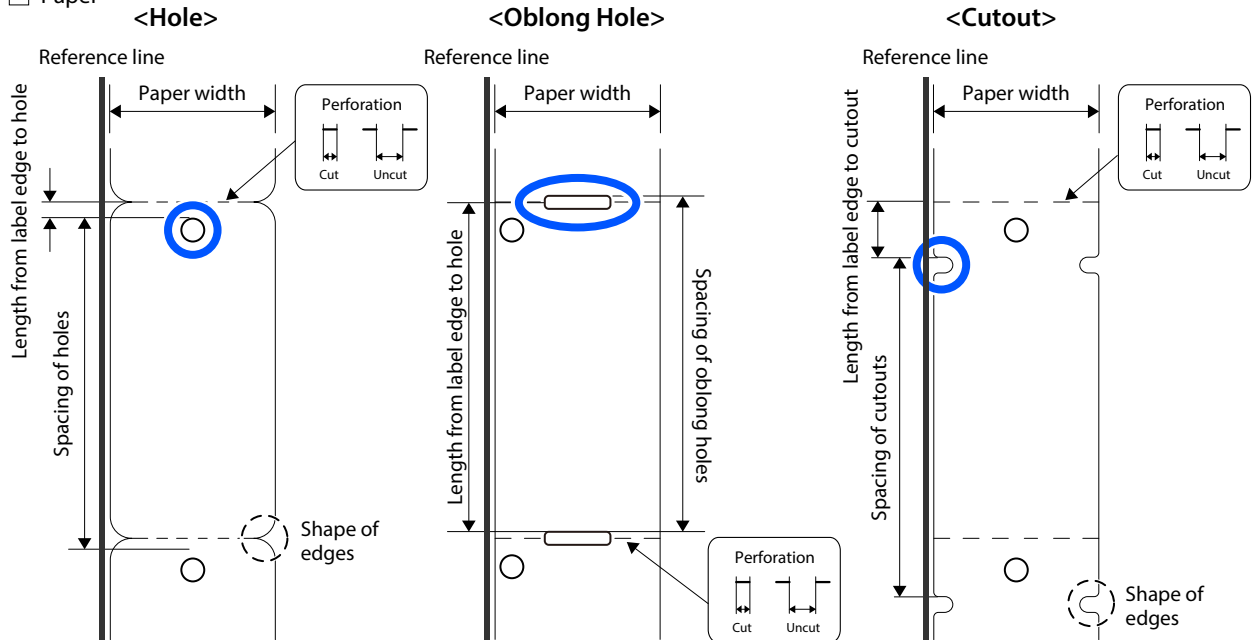

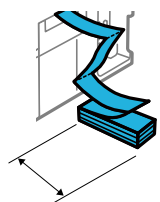
Item	Specifications
Paper Type	Plain paper, Matte paper, Glossy paper
Paper width	50 to 112 mm {1.97 to 4.41 in.}
Paper thickness	Up to 0.6 mm {0.24 in.}
Spacing of holes for paper detection (holes, oblong holes and cutouts)	11 to 306 mm {0.43 to 12.05 in.}
Paper detection method	Holes, oblong holes, or cutouts for paper detection
Length from label edge to hole/cutout	0 to 306 mm {0.00 to 12.05 in.} (distance from print start position to top of hole)
Dimensions of hole for paper detection (holes, oblong holes and cutouts)	Allowable hole dimensions depend on how far away the hole is from the paper's reference line. However, the allowable dimensions of cutouts do not vary depending on the distance from the paper's reference line. "Allowable Tag Holes Dimensions by Distance from Paper Reference Line" on page 381
Fold interval 	152.4 to 304.8 mm {6.00 to 12.00 in.}
Number of folds	750 or less
Perforation form	3 to 5 mm {0.12 to 0.20 in.} of slit length with 1 mm {0.04 in.} interval * There should be no slits at both side edges of paper
Shape of tag edges	R (round chamfering) 1.5 mm {0.06 in.} or less C (chamfering) 1.5 mm {0.06 in.} or less



When paper cannot be used because its holes, oblong holes, or cutouts for paper detection are not detected, it may be possible to use the paper by adjusting the sensitivity of the sensor or the threshold for label detection.

["Adjusting Detectors Sensitivity and Label Detection Thresholds" on page 293](#)

Allowable Tag Holes Dimensions by Distance from Paper Reference Line

The allowable dimensions of holes and oblong holes for paper detection depend on the distance (X) from the reference line of the paper.

The allowable dimensions of cutouts do not vary depending on the distance from the paper's reference line.

		Distance (X) from Paper Reference Line* (unit: mm/inch)						
		$0 \leq X \leq 1.35$	(1) $1.35 < X \leq 4.6$		(2) $4.6 < X \leq 10.9$		(3) $10.9 < X$	
Detection setting	Dimensions	--	Min	Max	Min	Max	Min	Max
Hole	Diameter (Φ)	No holes allowed here	3/0.12	3.5/0.14	3/0.12	9/0.35	3/0.12	12.7/0.50
Oblong hole	Paper feed direction (L)	No holes allowed here	3/0.12	3.5/0.14	3/0.12	9/0.35	3/0.12	12.7/0.50
	Paper width direction (W)	No holes allowed here	3/0.12	4.6/0.18	3/0.12	12.7/0.50	3/0.12	12.7/0.50
Cutouts	Paper feed direction (L)	3/0.12	3/0.12	3.5/0.14	3/0.12	3.5/0.14	3/0.12	3.5/0.14
	Paper width direction (W)	4.35/0.17	4.35/0.17	6.35/0.25	4.35/0.17	6.35/0.25	4.35/0.17	6.35/0.25

* The shortest distance from the edge of the hole or oblong hole to the paper reference line.

□ Hole (for paper detection)

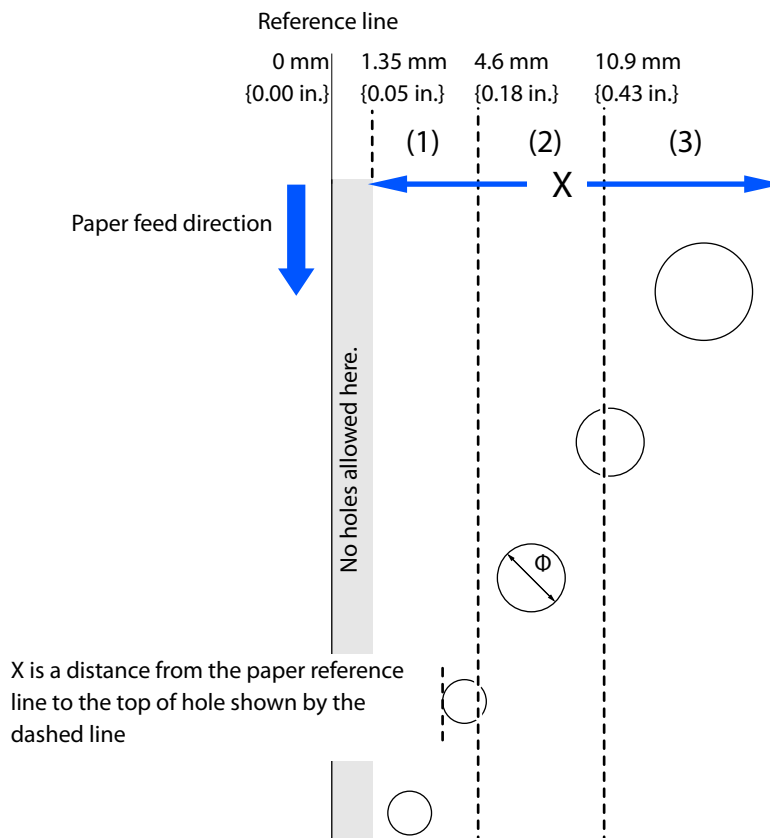

❑ Oblong Hole (for paper detection)

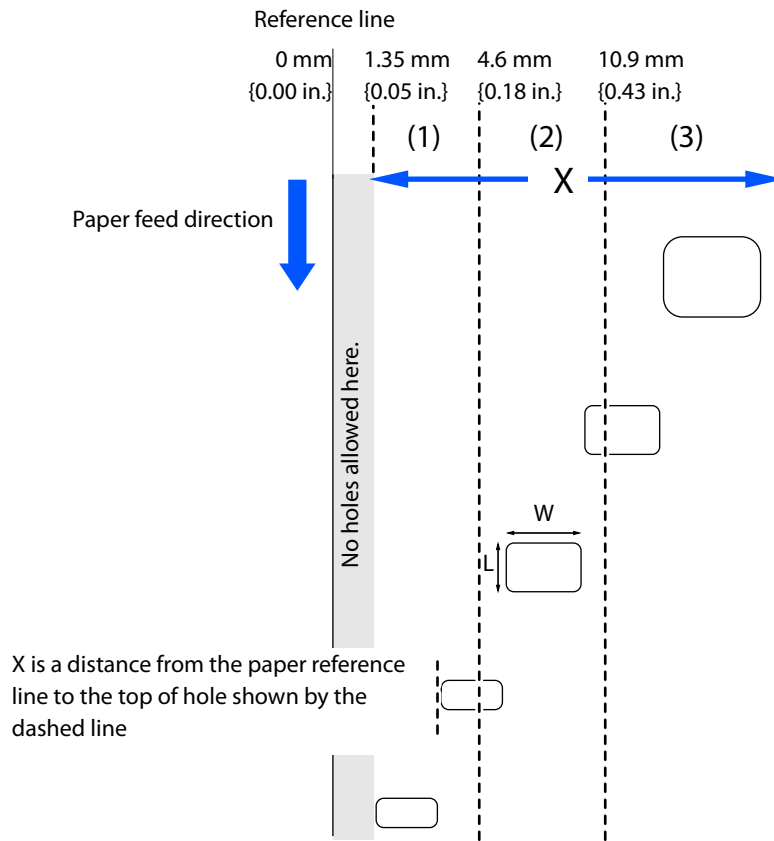



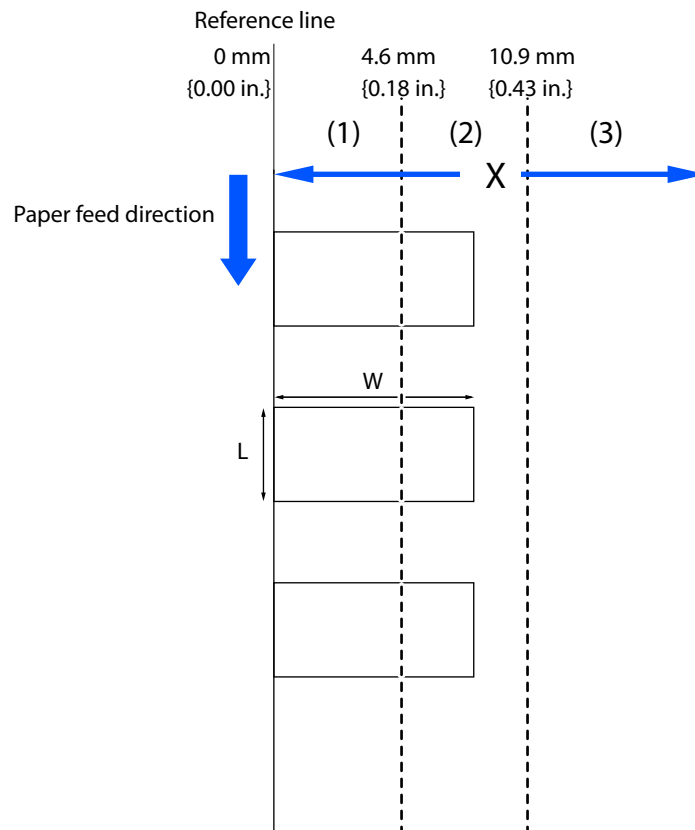

❑ Cutouts (for paper detection)



Printable Area

Continuous Paper

-  Paper feed direction
 Printable area
 Paper
 Black mark position
 (reverse side)
 * User setting items

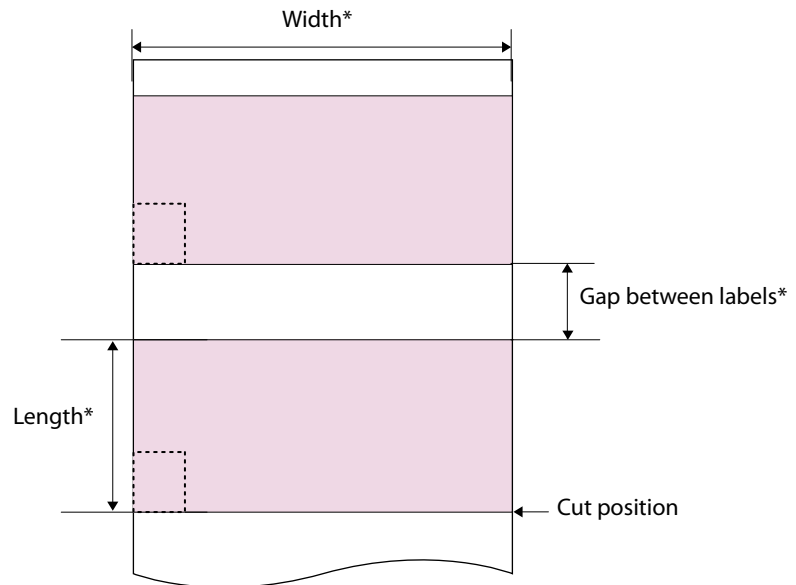

- If the left and right gaps are less than 2 mm {0.08 in.}, ink may smudge on the label or hands.
- Adding a margin of 1.5 mm {0.06 in.} or more at the top edge of the print area may reduce the ink stains.

Die-cut Label (Black Mark), Die-cut Label (without black marks)

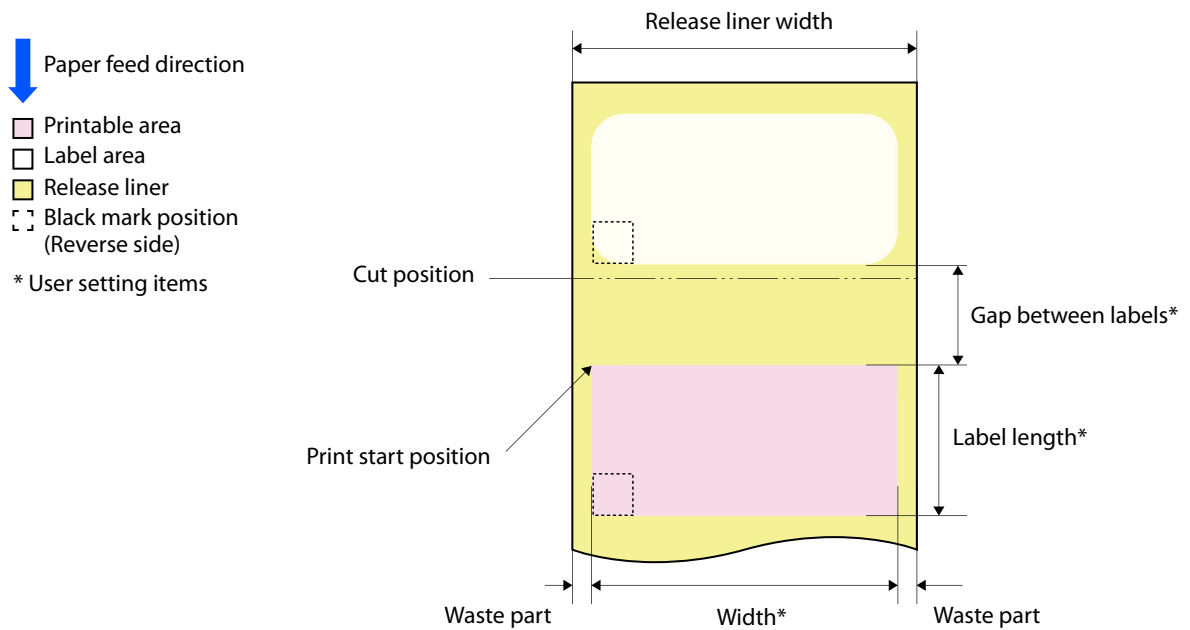

- If the left and right gaps are less than 2 mm {0.08 in.}, ink may smudge on the label or hands.
- Adding a margin of 1.5 mm {0.06 in.} or more at the top edge of the print area may reduce the ink stains.

Full-page Label (Black Mark)

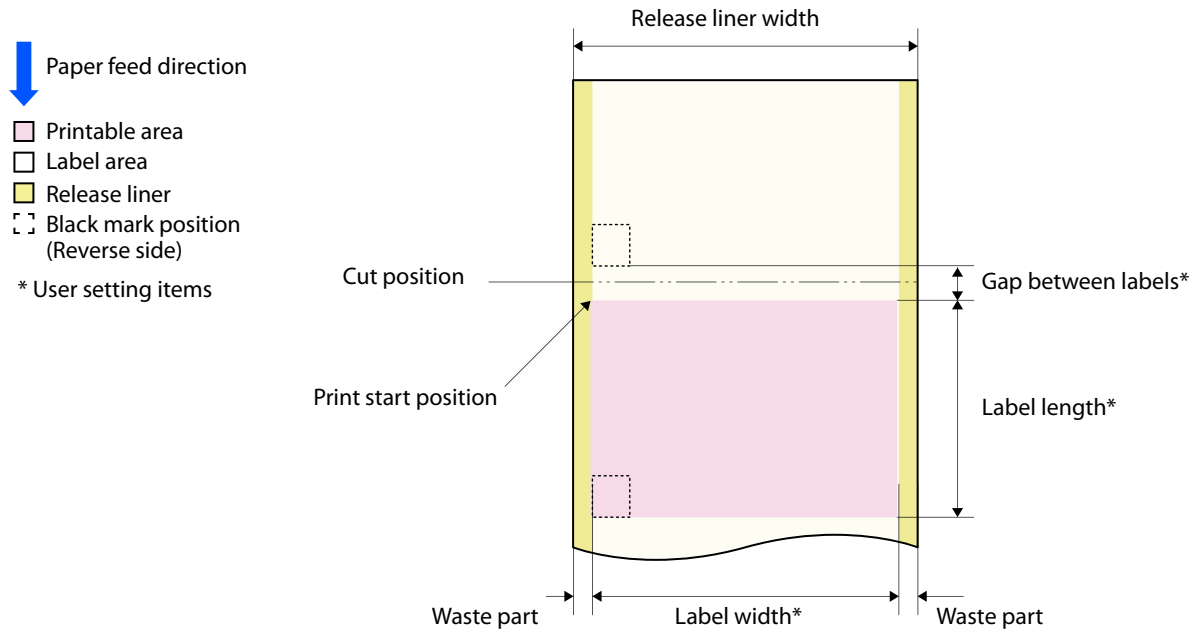

- If the left and right gaps are less than 2 mm {0.08 in.}, ink may smudge on the label or hands.
- Adding a margin of 1.5 mm {0.06 in.} or more at the top edge of the print area may reduce the ink stains.

Full-page label (without black marks)

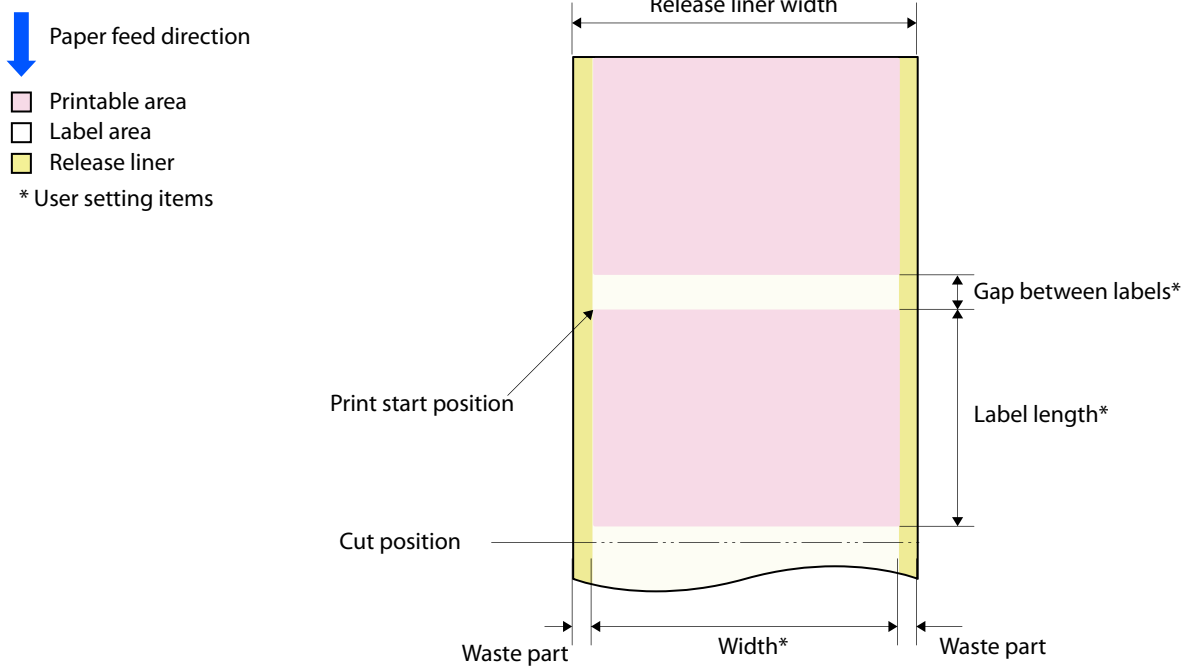

- If the left and right gaps are less than 2 mm {0.08 in.}, ink may smudge on the label or hands.
- Adding a margin of 1.5 mm {0.06 in.} or more at the top edge of the print area may reduce the ink stains.

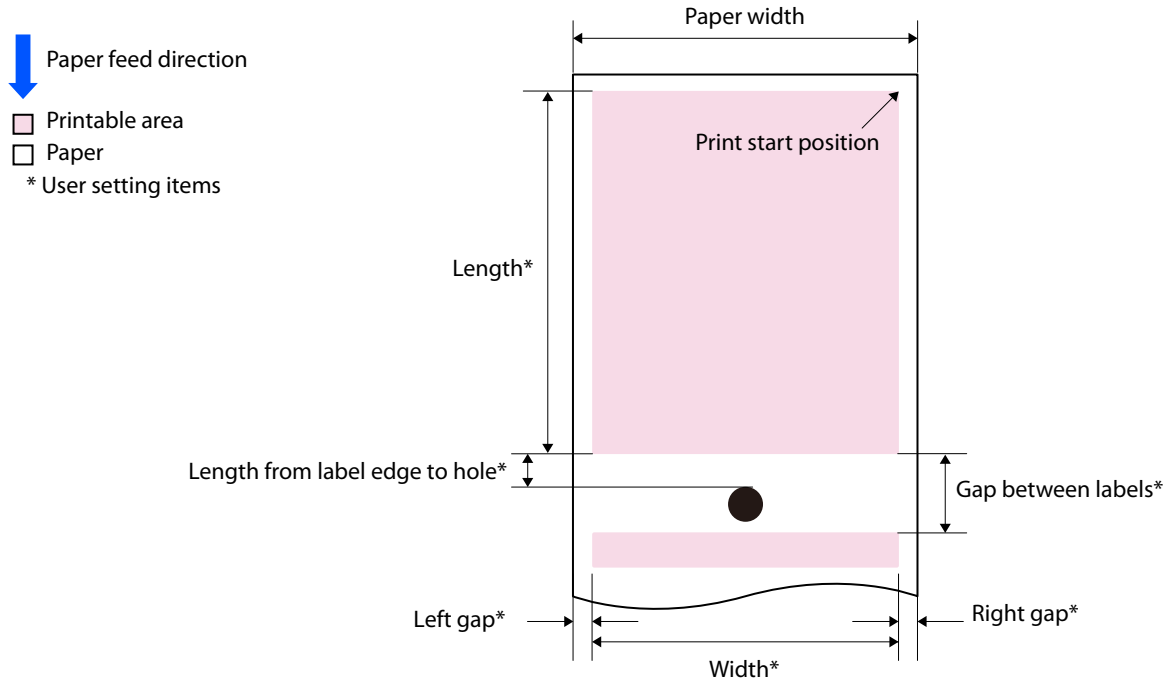

Tag (hole, oblong hole, cutouts)

□ When using holes for paper detection



- If the left and right gaps are less than 2 mm {0.08 in.}, ink may smudge on the label or hands.
- Adding a margin of 1.5 mm {0.06 in.} or more at the top edge of the print area may reduce the ink stains.

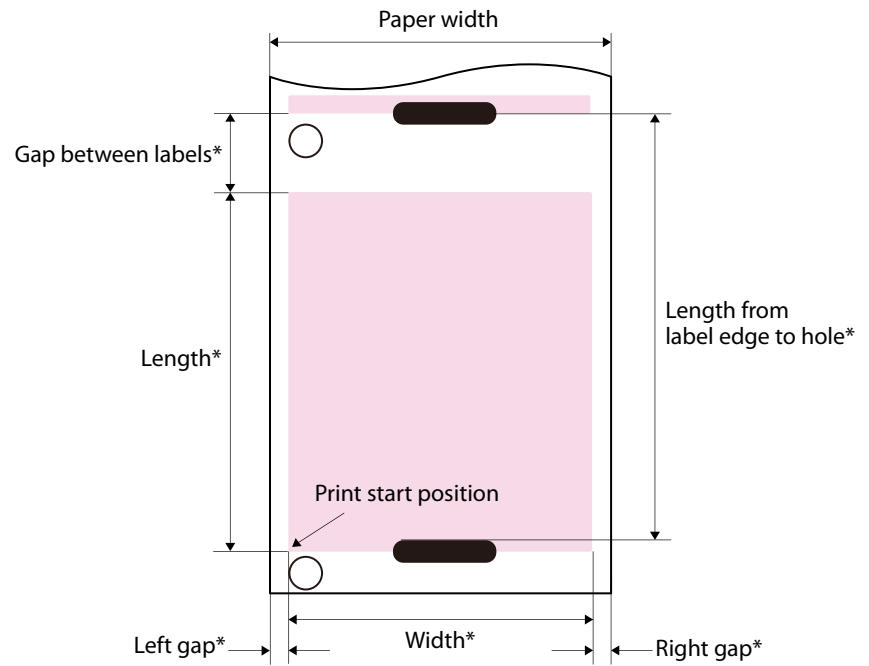

□ When using oblong holes for paper detection

-  Paper feed direction
 Printable area
 Paper
 * User setting items



- If the left and right gaps are less than 2 mm {0.08 in.}, ink may smudge on the label or hands.
- Adding a margin of 1.5 mm {0.06 in.} or more at the top edge of the print area may reduce the ink stains.

□ When using cutouts for paper detection

-  Paper feed direction
 Printable area
 Paper
 * User setting items

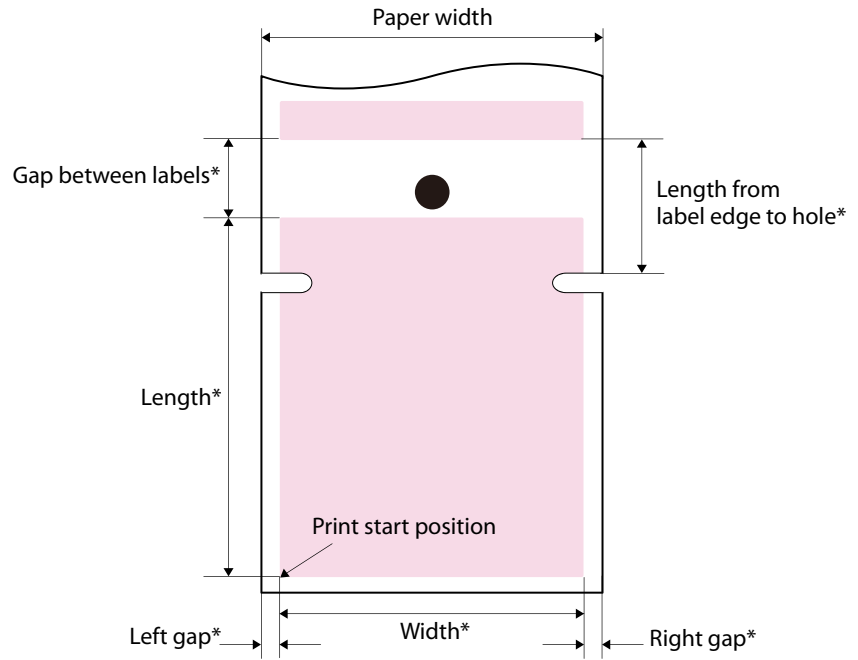

- If the left and right gaps are less than 2 mm {0.08 in.}, ink may smudge on the label or hands.
- Adding a margin of 1.5 mm {0.06 in.} or more at the top edge of the print area may reduce the ink stains.

Paper Detection System

Detector	Label detector (transmissive photo interrupter)
	Black mark detector (reflective photo interrupter)
Detection method	Paper is detected by the label detector and the black mark detector.



- When using die-cut label paper without black marks, use paper with a light transmittance of at least 40% for the backing paper and 23% or less for the label portion.
- When using black marks to detect paper, use paper with black marks reflectance of 10% or less and a white reflectance of 70% or more.
- When preprinting on the reverse side of continuous paper, do not preprint in the area shown in the figure because it will affect the paper detection performance.

Paper
 Do not preprint here

 Paper feed direction

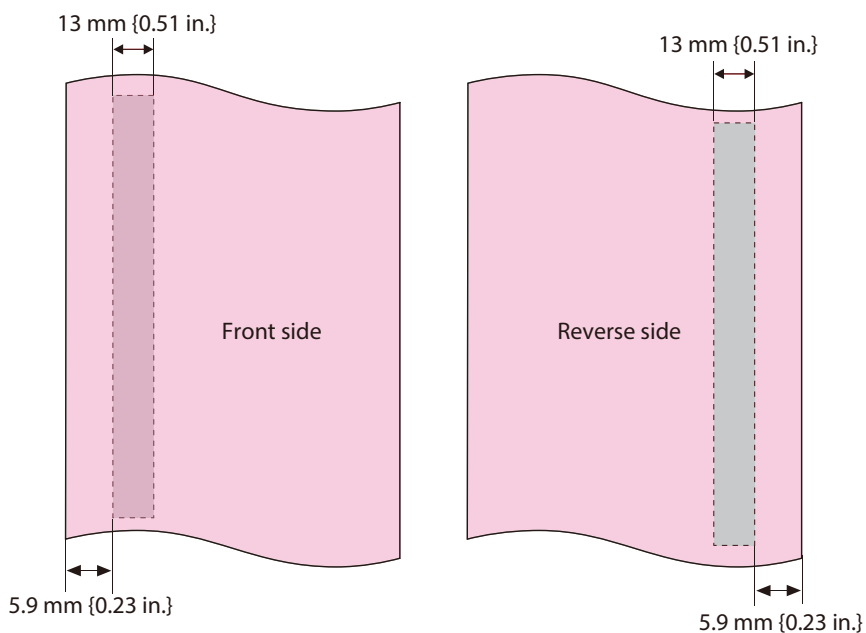

Electrical Specifications

Item		Specifications
Power supply		Power supply through a power connector
Rated voltage		100 to 240 V
Rated current		1.4 A
Power consumption*	Operating*	Approx. 83.0 W on average
	Standby	Approx. 3.32 W on average
	Power off	Approx. 0.41 W on average

* Based on Epson evaluation conditions

Reliability

Product life	Printer	When any one of the following is reached <ul style="list-style-type: none"> • 5 years • 500 km or 3.21 million labels (label length 152.4 mm {6 in.}) • 1.5 million one-way carriage movements (750,000 cycles) • 85,000 valve operations • 900,000 operations of the Ink Supply Pump 	
	Auto cutter mechanism (Number of cuts)	Continuous paper (plain paper)	1,500,000
		Continuous paper (matte paper)	700,000
		Continuous paper (glossy paper)	700,000
		Die-cut label (plain paper)	1,500,000
		Die-cut label (texture paper)	500,000
		Die-cut label (matte paper)	1,500,000
		Die-cut label (synthetic)	500,000
		Die-cut label (glossy paper)	1,500,000
		Die-cut label (glossy film)	500,000
		Die-cut label (high glossy paper)	1,500,000
		Full-page label (plain paper)	750,000
		Full-page label (matte paper)	500,000
		Full-page label (synthetic)	100,000
		Full-page label (glossy paper)	300,000
		Full-page label (glossy film)	100,000
		Full-page label (high glossy paper)	200,000
		Full-page label (texture paper)	100,000
		Tag (plain paper/0.2 mm thick or less)	100,000
Tag (glossy paper/0.2 mm thick or less)	100,000		



- Depending of paper used, the reliability values may differ.
- The cutter reliability may differ if paper is changed to wider paper because it causes differences partially in degree of wear of the cutter blade.

Environmental Specifications

Item		Specifications	
Temperature/ humidity	Printing	5 to 35°C {41 to 95 °F}, 20 to 80% RH without condensation (the blue-colored range in the graph)	
	Barcode printing	15 to 35°C {59 to 95 °F}, 20 to 80% RH without condensation	
	Storage	When packed (ink not charged)	
When ink charged		Gloss Ink Type	-15 to 40°C {5 to 104 °F} (Within 6 months at 0 to 25°C {32 to 77 °F}) (Within 1 month at 40°C {104 °F})
		Matte Ink Type	-10 to 40°C {14 to 104 °F} (Within 6 months at 0 to 25°C {32 to 77 °F}) (Within 1 month at 40°C {104 °F})
Elevation		0 to 3000 m	
Noise	Printer only	Approx. 57 dB Based on Epson evaluation conditions.	
	With the rewinder connected	Approx. 60 dB Based on Epson evaluation conditions.	

Overall Dimensions

Item	Specifications
Height	420 mm {16.54 in.}
Width	620 mm {24.41 in.}
Depth	392 mm {15.43 in.}

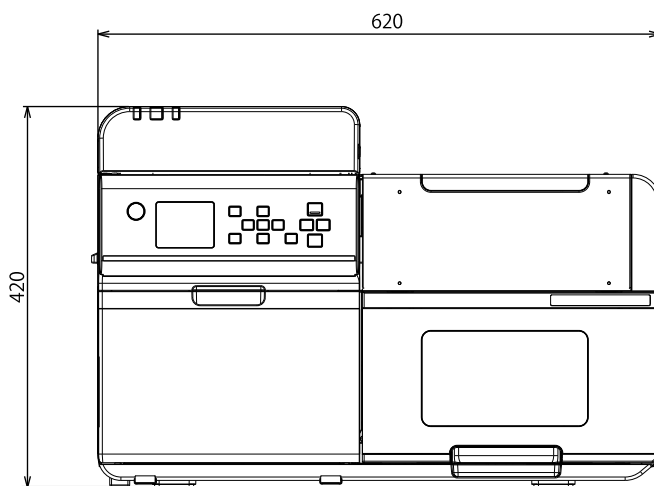
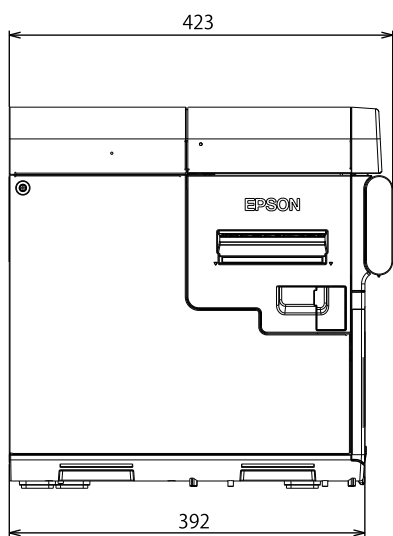

Unit: mm

- When the all covers are opened

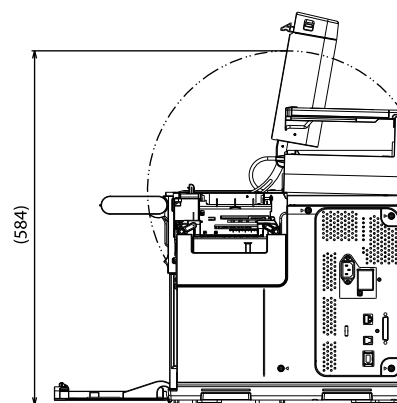
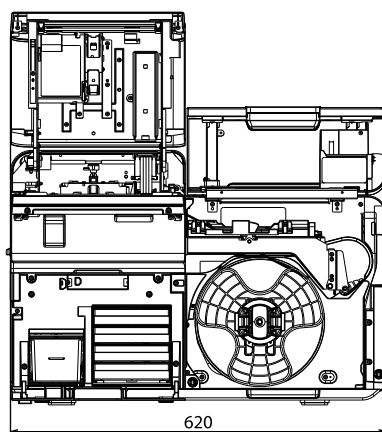
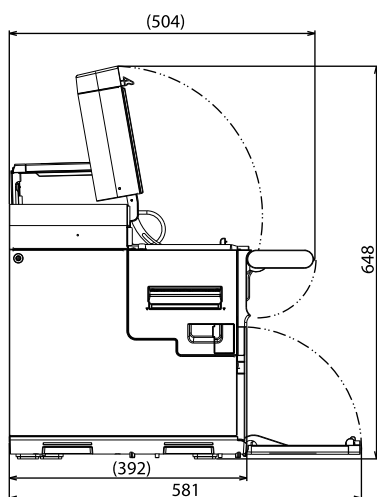

Unit: mm

- When the rewinder is connected

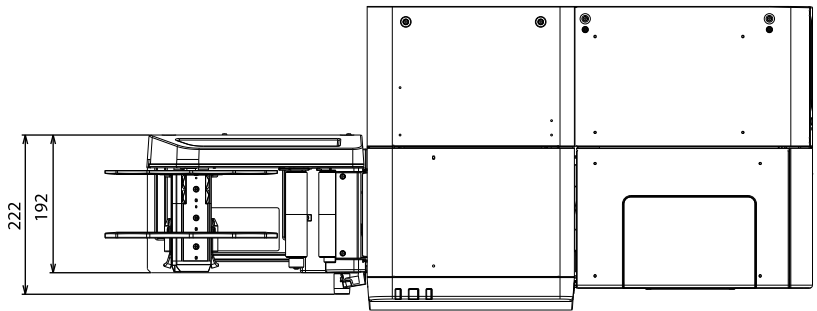
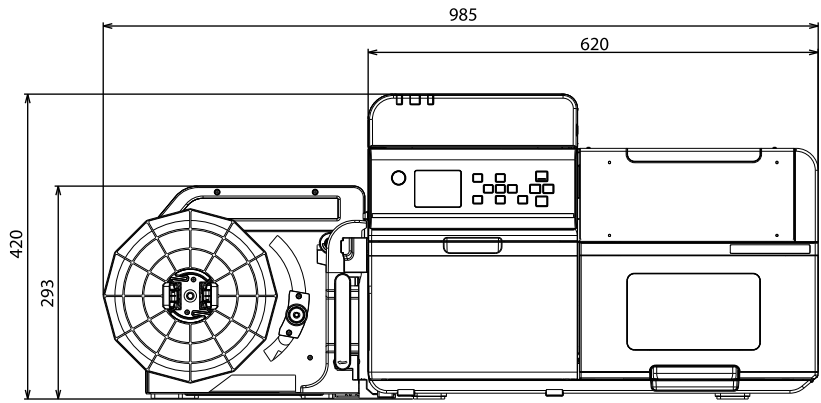
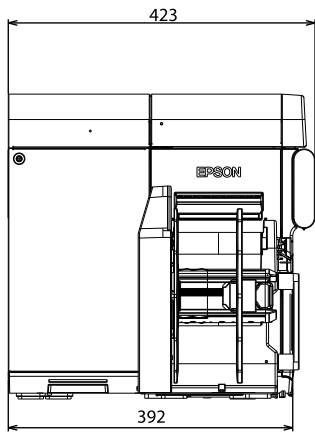

Unit: mm

Consumables Specifications

Ink Packs

Item		Specifications
Model number	CW-C8000u	SJIC47P-BK SJIC47P-MK SJIC47P-C SJIC47P-M SJIC47P-Y
	CW-C8000e CW-C8010	SJIC48P-BK SJIC48P-MK SJIC48P-C SJIC48P-M SJIC48P-Y
	CW-C8030	SJIC51P-BK SJIC51P-MK SJIC51P-C SJIC51P-M SJIC51P-Y
	CW-C8040 CW-C8050	SJIC52P-BK SJIC52P-MK SJIC52P-C SJIC52P-M SJIC52P-Y
Type		4 individual color packs
Ink colors		Black (gloss black (BK), matte black (MK)), cyan (C), magenta (M), yellow (Y)
Ink type		Water-based pigmented ink
Expiration date		1 year after installation in the printer, 3 years from the date of manufacture including the period of use
Storage temperature	Transporting (without unpacking)	-20 to 60°C {-4 to 140 °F} (Within 4 days at -20°C {-4 °F}, Within 1 month at 40°C {104 °F}, Within 3 days at 60°C {140 °F})
	Storage (without unpacking)	-20 to 40°C {-4 to 104 °F} (Within 4 days at -20°C {-4 °F}, Within 1 month at 40°C {104 °F})
	Installed	-20 to 40°C {-4 to 104 °F} (Within 4 days at -20°C {-4 °F}, Within 1 month at 40°C {104 °F})

CAUTION

The ink in the ink packs may freeze if left in an environment below -20°C {-4 °F}.

Maintenance Box

Item		Specifications
Model number		SJMB7500
Type		Maintenance box with integrated waste ink absorbing material
Storage temperature	Transporting (without unpacking)	-20 to 60°C {-4 to 140 °F} (within 5 days at 60°C {140 °F})
	Storage (without unpacking)	-20 to 40°C {-4 to 104 °F} (within 1 month at 40°C {104 °F})
	Installed	-20 to 40°C {-4 to 104 °F} (within 1 month at 40°C {104 °F})

Option

Rewinder (TU-RC8000)

The rewinder is a device used to rewind printed paper into a roll.



CAUTION

Be careful not to get hands, hair, etc. caught in the operating parts while the rewinder is in operation.

Specifications

Item		Specifications
Overall Dimensions	Height	293 mm {11.54 in.}
	Width	403 mm {15.87 in.}
	Depth	222 mm {8.74 in.}
Weight		4.25 kg {9.37 lb}

Connecting the Rewinder

Follow the steps below to install the rewinder.

- 1 Open the rewinder connection cover on the left side of the printer.

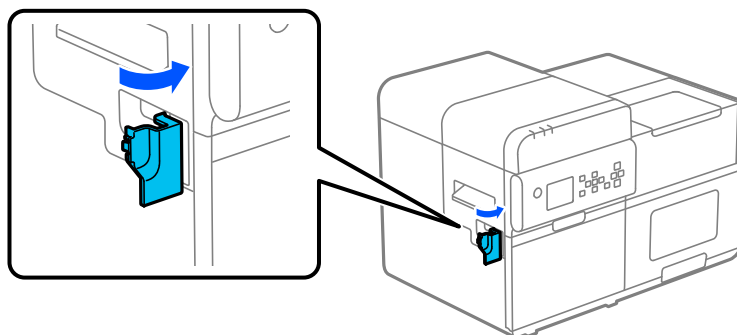

2 Place the rewriter on the left side of the printer.

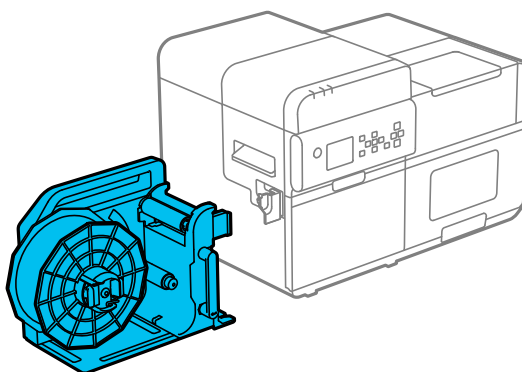
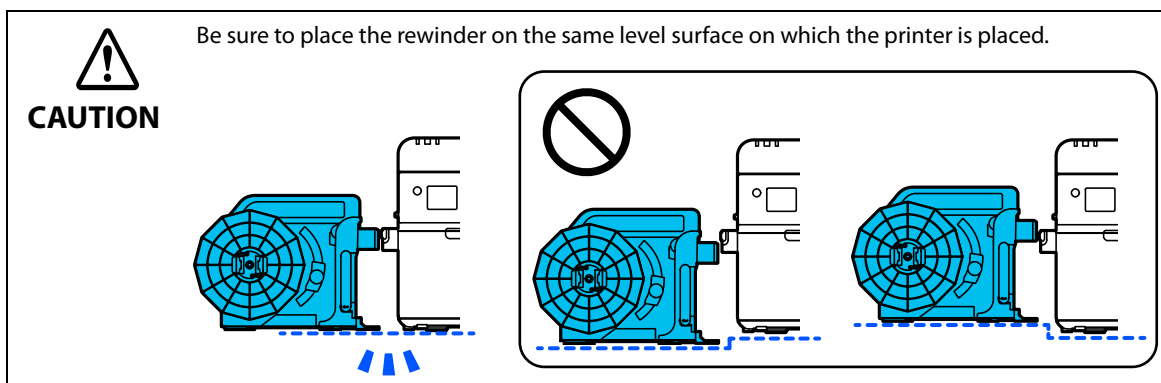

3 Insert the coupling gear of the rewriter into the rewriter connection opening of the printer. Insert the gear straight against the opening.

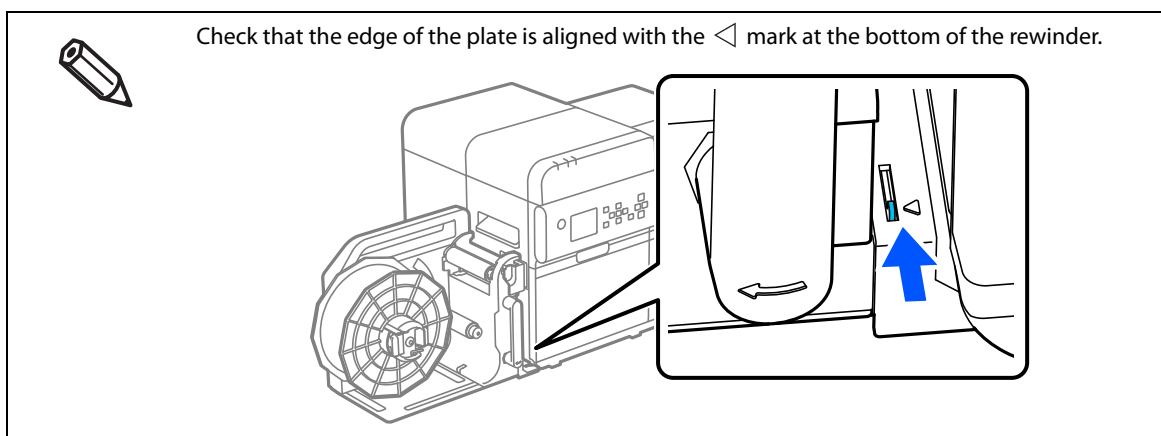
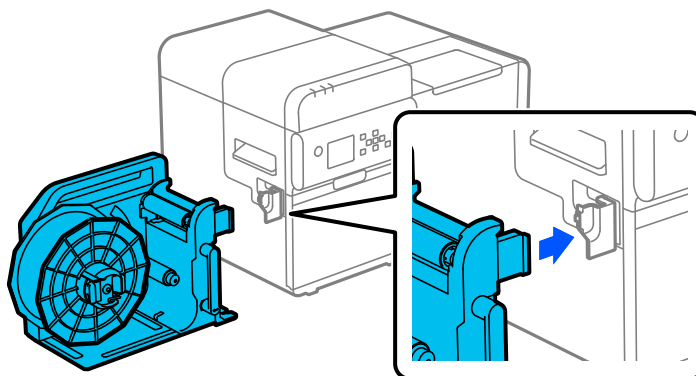

Removing the Rewinder

Move the rewriter lever in the direction of the arrow and remove the rewriter.

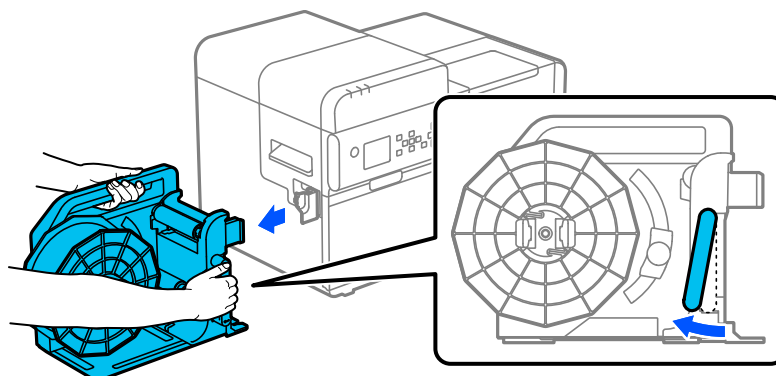

Attaching Paper to the Rewinder

Follow the steps below to attach paper to the rewriter.

- 1 While squeezing the tabs of the rewriter flange, remove the flange from the rotating shaft.

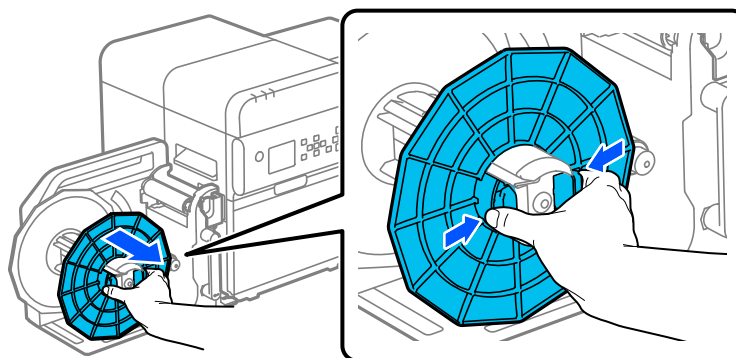

- 2 Press the ← (feed) button until about 800 mm {31.50 in.} of paper comes out of the printer.

- 3 Pass the paper through the rewriter as shown in the figure below.

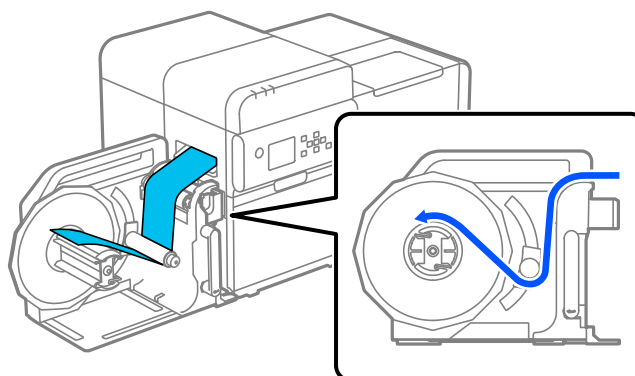

Depending on the thickness and stiffness of the paper, the rewriter may not wind the paper correctly.

4 Fix the leading edge of the paper to the winding core or insert it into the gap in the rotating shaft.

□ When using the winding core

Align the side edge of the paper with that of the core, and secure the leading edge of the paper to the core with tape. Then, rotate the rewinder flange about 2 times to take up the slack in paper.

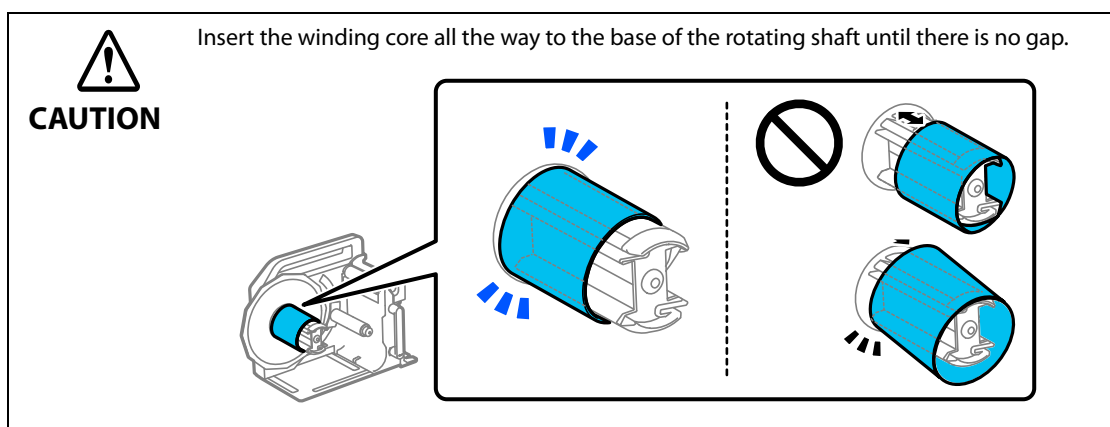
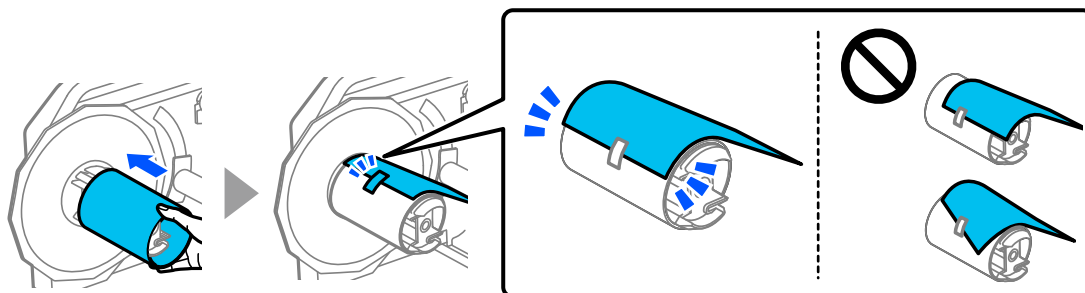

□ When not using the winding core

Insert the leading edge of the paper into the gap in the rotating shaft. Then, rotate the rotating shaft about 2 times to take up the slack in paper.

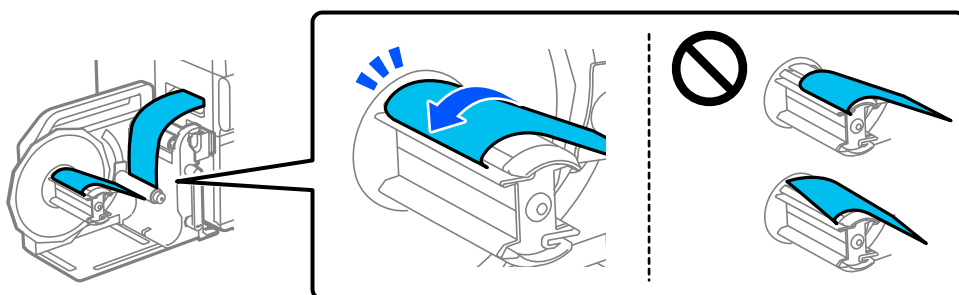

- 5** While squeezing the tabs of the rewinder flange, attach the flange to the rotating shaft.

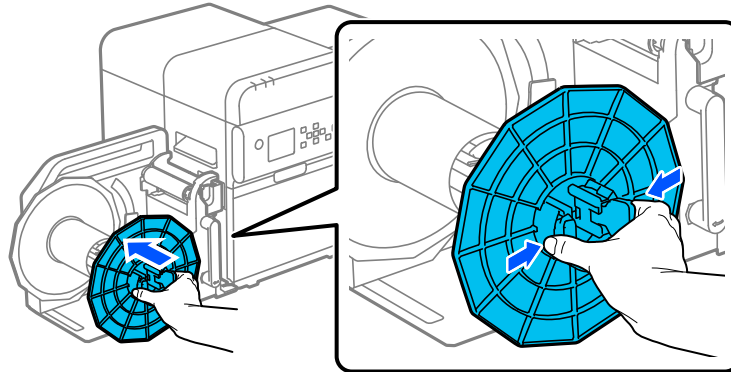

CAUTION

Attach the rewinder flange so that there is no gap between the flange and the winding core.

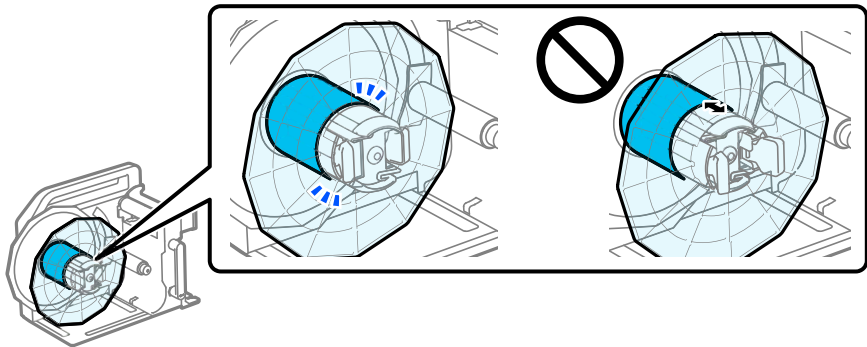

- If you forget to attach the rewinder flange, the roll paper may meander and may not be able to be wound properly. Be sure to always attach the rewinder flange.
- Paper wound up by the rewinder may be wound looser than the original roll. When installing the roll in a post-processing machine, it is recommended to tighten the roll before installation.

Downloading Printer Driver, Utilities, and Manuals

The latest versions of the printer driver, utilities, and manuals can be downloaded from the following URLs.

For customers in North America, go to the following web site:

<https://www.epson.com/support/>

For customers in other countries and regions, go to the following web site:

<https://epson.sn>

Label Print Applications

Some commercially available label print applications offer a printer driver for this printer allowing you to use the printer easily from the applications. By using the printer driver, you can make the printer settings and use the printer functions.

When you use the printer driver, you do not need to use the Epson printer driver.

The label print applications that offer a printer driver for this printer are listed below.

- BarTender
- NiceLabel
- CODESOFT

How to Get Software

BarTender

<https://www.bartendersoftware.com/>

NiceLabel

<https://www.nicelabel.com/>

CODESOFT

<https://www.teklynx.com/>