

UB-E02 Technical Reference Guide

10Base-T/100Base-TX
Ethernet Interface board



EPSON

English

404999001

CAUTIONS

- ❑ This document shall apply only to the product(s) identified herein.
- ❑ No part of this document may be reproduced, stored in a retrieval system, or transmitted in any form or by any means, electronic, mechanical, photocopying, recording, or otherwise, without the prior written permission of Seiko Epson Corporation.
- ❑ The contents of this document are subject to change without notice. Please contact us for the latest information.
- ❑ While every precaution has been taken in the preparation of this document, Seiko Epson Corporation assumes no responsibility for errors or omissions.
- ❑ Neither is any liability assumed for damages resulting from the use of the information contained herein.
- ❑ Neither Seiko Epson Corporation nor its affiliates shall be liable to the purchaser of this product or third parties for damages, losses, costs, or expenses incurred by the purchaser or third parties as a result of: accident, misuse, or abuse of this product or unauthorized modifications, repairs, or alterations to this product, or (excluding the U.S.) failure to strictly comply with Seiko Epson Corporation's operating and maintenance instructions.
- ❑ Seiko Epson Corporation shall not be liable against any damages or problems arising from the use of any options or any consumable products other than those designated as Original EPSON Products or EPSON Approved Products by Seiko Epson Corporation.

TRADEMARKS

EPSON® and ESC/POS® are registered trademarks of Seiko Epson Corporation.

Microsoft and Windows are registered trademarks of Microsoft Corporation.

General Notice: Other product and company names used herein are for identification purposes only and may be trademarks of their respective companies.

Revision Information

Revision	Page	Altered Items and Contents
Rev. A		

About This Guide

This guide is intended to provide all information necessary for system planning, design, installation and application of the UB-E02 for designers and developers of POS systems.

Contents of the Guide

The configuration of the guide is as follows:

Chapter 1, "System Preparation"	Supported operating system, network protocols, TM printers, and other limitations.
Chapter 2, "Installation"	Gives information on how to install and use the UB-E02.
Chapter 3, "Utilities"	Gives information on how to use the utilities.
Chapter 4, "Programming Samples"	Includes practical programming information.
Chapter 5, "Specification"	Gives specifications.
Appendix A, "Definitions"	Provides definitions of terms used in this guide.

Related Documents

Software/document name	Description
UB-E02 User's Manual	Provides instructions for operators of POS systems in which the UB-E02 is installed so that the operators can use the UB-E02 safely and correctly.

EMC and Safety Standards Applied

Product Name: UB-E02
Model Name: M155B

The following standards are applied only to the interface boards that are so labeled. (EMC is tested using the EPSON power supplies and TM series printers.)

Europe:	CE marking
North America:	EMI: FCC/ICES-003 Class A
Japan:	EMC: VCCI Class A
Oceania:	EMC: AS/NZS 3548, CISPR22 Class B

WARNING

The connection of a non-shielded interface cable to this board will invalidate the EMC standards of this device.

You are cautioned that changes or modifications not expressly approved by Seiko Epson Corporation could void your authority to operate the equipment.

CE Marking

The board conforms to the following Directives and Norms:

Directive 89/336/EEC	EN 55022 Class B EN 55024 IEC 61000-4-2 IEC 61000-4-3 IEC 61000-4-4 IEC 61000-4-5 IEC 61000-4-6 IEC 61000-4-11
----------------------	---

The printer in which this board is installed does not conform to the following:

Directive 90/384/EEC	EN45501
----------------------	---------

FCC Compliance Statement For American Users

This equipment has been tested and found to comply with the limits for a Class A digital device, pursuant to Part 15 of the FCC Rules. These limits are designed to provide reasonable protection against harmful interference when the equipment is operated in a commercial environment.

This equipment generates, uses, and can radiate radio frequency energy and, if not installed and used in accordance with the instruction manual, may cause harmful interference to radio communications. Operation of this equipment in a residential area is likely to cause harmful interference, in which case the user will be required to correct the interference at his own expense.

For Canadian Users

This Class A digital apparatus complies with Canadian ICES-003.

Cet appareil numérique de la classe A est conforme à la norme NMB-003 du Canada.

 **CAUTION:**

Connecting an outdoor overhead LAN cable directly to your product

Connecting an outdoor overhead LAN cable directly to your product may lead to lightning damage. If you need to connect such a cable to your product, the cable must be protected against an electrical surge between the cable and your product. You should avoid connecting your product to a non-surge protected outdoor overhead LAN cable.

GERÄUSCHPEGEL

Gemäß der Dritten Verordnung zum Gerätesicherheitsgesetz (Maschinenlärminformations- Verordnung-3. GSGV) ist der arbeitsplatzbezogene Geräusch-Emissionswert kleiner als 70 dB(A) (basierend auf ISO 7779).

Key to Symbols

The following symbols are used in the documentation for this product. See the specific warnings and cautions at appropriate points throughout this guide.

 **WARNING:**

Warnings must be followed carefully to avoid serious bodily injury.

 **CAUTION:**

Cautions must be observed to avoid minor injury to yourself, damage to your equipment, or loss of data.

 **Note:**

Notes have important information and useful tips on the operation of the product.

Safety Precautions

This section presents important information to ensure safe and effective use of this product. Please read this section carefully and store it in an accessible location.

CAUTION:

- ❑ *Be careful to avoid dropping conductive objects such as paper clips on the circuit board, as they could short circuit connections and cause damage from excessive current.*
- ❑ *This product should only be connected to the devices specified in this guide. Connecting other devices could cause damage, fire or explosion.*
- ❑ *Never disassemble or modify this product. Tampering with this product may result in injury, fire, or electric shock.*
- ❑ *Be sure to set the product on a firm, stable, horizontal surface. The product may break or cause injury if it falls.*
- ❑ *Never connect a public telephone line to the modular connector on this product.*
- ❑ *Do not use in locations subject to high temperature, humidity or dust levels. Excessive temperature, humidity or dust may cause equipment damage, fire, or shock.*
- ❑ *Parts on the circuit board may become hot during operation. Therefore, wait approximately 10 minutes after turning the power off before touching them.*
- ❑ *To prevent the possibility of electrical shock, do not perform installation or connect cables during a thunderstorm.*

Label

A caution label like the one is attached near the display module connector of the TM printers.



The label has the following meaning:

“The display module connector and the drawer kick-out connector use the same type of Ethernet connector; therefore, be sure not to connect the Ethernet connector cable or the telephone line to the display module connector or the drawer kick-out connector.”

Product Servicing

This product cannot be serviced at the component level. If damage occurs, the UB-E02 should be replaced as a unit.

Introduction

The UB-E02 is the 10Base-T/100Base-TX Ethernet interface board designed for the EPSON® TM printers. The board lets you connect your EPSON printer directly to your network and use it as a kitchen printer.

Operating Environments

Supported Operating Systems

- ❑ Microsoft® Windows® 95, Windows® 98 Second Edition, Windows® 2000 Professional, and Windows®XP Professional
- ❑ Windows NT® 4.0

Supported Protocols

- ❑ TCP/IP

Environments for Setup Utility

- ❑ EPSON TMNet WinConfig applies to the following versions of Windows:
 - Windows 95
 - Windows 98 Second Edition
 - Windows 2000 Professional
 - Windows XP Professional
 - Windows NT 4.0
- ❑ EPSON TMNet WebConfig is recommended to be used with the following internet browser:
 - Microsoft Internet Explorer version 5.0 or later

Supported TM Printers

The following printers can use the UB-E02.
(The TM-J8000, TM-T285, and RP-U420 cannot use the UB-E02.
For new models, please ask your dealer.)

- TM-U200 Series
- TM-U210 Series
- TM-U230
- TM-U325
- TM-U590
- TM-U675
- TM-T88/T88II/T88III
- TM-T90
- TM-H5000/H5000II
- TM-H6000/H6000II
- TM-J2000/J2100
- TM-J7000/J7100
- TM-J7500/J7600
- TM-L90

How to Use this Guide

Installation Overview

Be sure to read Chapter 1, “System Preparation,” before using the product.

Perform the following steps to install and configure the UB-E02. See the indicated chapters for detailed information.

1. Install the UB-E02 in your printer. See Chapter 2.
2. Install the TCP/IP protocol in your operating system, if necessary. See Chapter 5.
3. Set the functions of the UB-E02. See Chapter 5.
4. To set the functions of the UB-E02 using the EPSON TMNet WebConfig utility, you need to use Microsoft Internet Explorer. If it is not installed, install it, referring to the browser’s manual.

Programming

The Chapter 6 provides you with a sample program of printing by network.

Appendix

The appendix provides you with the glossary.

Contents

Chapter 1 System Preparation

Supported Operating Systems	1-1
Supported Network Protocols	1-1
Supported TM Printers	1-1
Other Limitations	1-2

Chapter 2 Installation

Installation Precautions	2-1
Unpacking	2-2
Part Names	2-2
Functions	2-2
Switch	2-2
LEDs	2-2
UB-E02 Installation	2-3
Initializing UB-E02	2-6
UB-E02 Status Sheet Printing	2-6
FAQ	2-7
Q1. The printer does not operate correctly. ("Serial interface" is printed by the self test for the printer.)	2-7
Q2. The self test does not operate correctly.	2-7
Q3. Starting up the printer takes a long time.	2-7

Chapter 3 Utilities

Setting the IP Address	3-1
Setting the IP Address using EPSON TMNet WinConfig	3-1
Setting the IP Address Using the arp/ping Command	3-11
EPSON TMNet WinConfig Functions	3-13
Menu Bar	3-14
EPSON TMNet WebConfig Functions	3-20
Opening Screen	3-20
Protocol Information and Settings	3-22

Chapter 4 Programming Samples

Method of Printing to the UB-E02	4-2
Buffer of the UB-E02	4-2
Direct Printing by PORT9100	4-3
For Windows Console	4-3
For Linux	4-5
Commands Sent to a TM Printer When the Power is On	4-6
Monitoring of the ASB status	4-6
The Priorities of Printing	4-6
Time-out for Connection	4-6
Printer Operation by the UDP Commands	4-7
Commands Packets	4-7
03-0000 Retrieving Basic Information	4-8
03-0010 Retrieving Status	4-8
03-0011 Forced Transmission	4-9
03-0012 Reset	4-9
03-0013 Buffer Flash	4-10
03-0016 Clearing Connection Time-Out Timer	4-10
Programming Sample	4-11

Chapter 5 Specifications

Printer Connection 5-1
 Line Display Connection 5-1
 Features 5-1
 Overview 5-1
 Printing Functions 5-2
 Functions to Monitor Settings 5-2
 Maintenance Functions 5-2
 Hardware Specifications 5-2
 Physical communications standard 5-2
 Board size 5-2
 External appearance and connector locations 5-3
 Software Specifications 5-3
 Basic Communications Protocols 5-3
 Printing Communications Protocols 5-3
 Status Inquiry and Setting Protocols 5-4
 Automatic IP Address Assignment Protocols 5-5
 Internal Settings 5-7
 Initializing 5-9
 Version Upgrading 5-9
 Environmental Specifications 5-10
 Storage Conditions 5-10
 EMC and Safety Standards Applied 5-10

Appendix A Definitions

A A-1
 D A-1
 E A-1
 I A-1
 M A-1
 N A-1
 P A-1
 S A-1
 T A-1
 U A-2

Chapter 1

System Preparation

1.1 Supported Operating Systems

- Microsoft Windows 95, Windows 98 Second Edition, Windows 2000 Professional, and Windows XP Professional
- Windows NT 4.0

1.2 Supported Network Protocols

- LPR
- Socket printing (port 9100 for OPOS)

1.3 Supported TM Printers

The following printers can use the UB-E02.

- TM-U200 Series
- TM-U210 Series
- TM-U220 Series
- TM-U230
- TM-U325
- TM-U590
- TM-U675
- TM-T88/T88II/T88III
- TM-T90
- TM-H5000/H5000II
- TM-H6000/H6000II
- TM-J2000/J2100
- TM-J7000/J7100
- TM-J7500/J7600
- TM-L90

The following printers cannot use the UB-E02.

- ❑ TM-J8000, TM-T285, RP-U420

1.4 Other Limitations

Be sure to note the following:

- ❑ When the UB-E02 is installed, the display module connector (DM-D) of the TM printer cannot be used.



CAUTION:

Do not connect the Ethernet connector cable to the display module connector (DM-D) or the drawer kick-out connector.

Chapter 2

Installation

2.1 Installation Precautions

WARNING

- ❑ *Before installing, disconnect the Power Unit from the TM Printer (as well as turning the power switch off).
Even when the power switch is off, voltage is still present at some points on the circuit board. Changing components while the Power Unit is connected can cause damage to the UB-E02 and the printer.*
- ❑ *A grounded wrist strap should be worn during installation, to avoid damage from static electricity.*
- ❑ *To avoid damage from static electricity when the unit is removed, place it on a static-safe surface such as conductive foam.*
- ❑ *Protect the unit from vibration and shock that could damage to the unit.*
- ❑ *Be careful to avoid dropping conductive objects such as paper clips on the circuit board, as they could short circuit connections and cause damage from excessive current.*
- ❑ *This product should only be connected to the devices specified in this guide. Connecting other devices could cause damage, fire or explosion.*
- ❑ *Do not attempt to wire this product other than as described in this document. Improper wiring could cause damage, fire or explosion.*
- ❑ *Never disassemble or modify this product. Tampering with this product may result in injury, fire, or electric shock.*
- ❑ *Do not use in locations subject to high temperature, humidity or dust levels. Excessive temperature, humidity or dust may cause equipment damage, fire, or shock.*
- ❑ *Never connect a public telephone line to the modular connector on this product.*
- ❑ *Parts on the circuit board may become hot during operation. Therefore, wait approximately 10 minutes after turning the power off before touching them.*
- ❑ *To prevent the possibility of electrical shock, do not perform installation or connect cables during a thunderstorm.*

2.2 Unpacking

- ❑ UB-E02
- ❑ UB-E02 User's Manual

2.3 Part Names

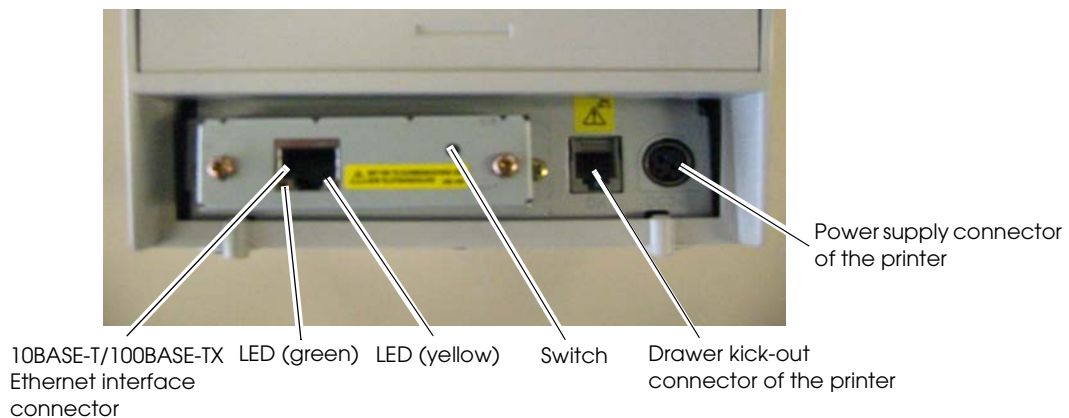

Note: This photograph shows the TM-T88III printer with the UB-E02 installed.

2.4 Functions

The switch and LEDs of the UB-E02 provide you with important information on operation and status of the UB-E02.

2.4.1 Switch

Type: Non-locking push switch

You can do the following with the switch.

- ❑ Setting initialization
All the parameters of internal settings for the UB-E02 can be set to the factory default values. See "Initializing UB-E02" on page 7 of this chapter for more details.
- ❑ Status sheet printing
The internal setting parameters of the UB-E02 can be printed. See "UB-E02 Status Sheet Printing" on page 7 of this chapter for more details.

2.4.2 LEDs

The UB-E02 has two LEDs.

The green LED is on when the Ethernet link is established.

The yellow LED is on when the printer receiving data.

2.5 UB-E02 Installation

CAUTION:

Before installing the UB-E02, be sure to set the DIP switches or Memory switches as shown in the table below. For other models, please ask your dealer.

Model	Setting
TM-U200 Series	DIP SW 2-8: ON
TM-U210 Series	DIP SW 2-8: ON
TM-U220 Series (STD) *1	DIP SW2-8: ON
TM-U220 Series (US) *1	DIP SW2-4: ON
TM-U230 Series	DIP SW 2-4: ON
TM-U325 Series	DIP SW 2-8: ON
TM-U590 Series	DIP SW 2-8: ON
TM-U675 Series	DIP SW 2-8: ON
TM-T88/T88II/T88III	DIP SW 2-8: ON
TM-T90	MSW 1-8: ON
TM-H5000/H5000II	DIP SW 2-8: ON
TM-H6000/H6000II	DIP SW 2-8: ON
TM-J7000/J7100	MSW 1-8: ON
TM-J7500/J7600	MSW 1-8: ON
TM-J2000/J2100	MSW 1-8: ON
TM-L90	MSW 1-8: ON

*1 TM-U220 has two DIP switch pattern. See TM-U220 Technical Reference Guide for detail.

Be sure to disconnect the power supply of the printer (in addition to turning off the power switch) .Even when the power switch is turned off, some of the internal circuit board has electricity. If you install or remove the UB-E02 with the power supply connected, the UB-E02 and the printer may be damaged.

1. Be sure that the power for the printer and host computer is turned off.
2. Install the UB-E02 in the printer.
If an interface circuit board is already installed, remove it and install the UB-E02.



3. Tighten the screws.
If you have removed an interface circuit board that was already installed, fix the UB-E02 using the removed screws.



4. Plug the twist pair cable into the 10BASE-T/100BASE-TX Ethernet connector of the UB-E02 until it clicks.

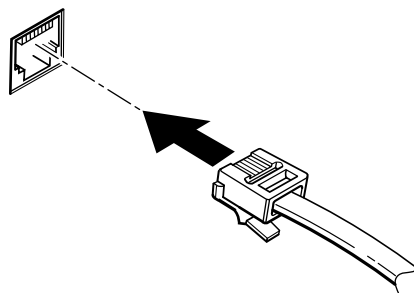

⚠ CAUTION:

Be sure not to connect a telephone line, display module connector, or drawer kick-out connector cable to the 10BASE-T/100BASE-TX Ethernet connector of the UB-E02.

The display module connector on the TM printer cannot be used when the UB-E02 is installed.

5. Connect the power unit to the printer.
6. Turn on the printer power.



When initializing the UB-E02 by turning off the power and then turning it back on or by resetting the printer, there is a waiting time until the network starts operating. During this time, all the communicating functions of the network do not work.

The waiting time is:

When the IP address setting is Manual (Fixed): approximately 6 seconds

When the IP address setting is Auto: approximately 13 seconds

(It can be longer, depending on the reply time of the host.)

7. Print a status sheet to check whether the UB-E02 is installed correctly by holding the switch down for more than 3 seconds when the printer is ready for printing. The version of the UB-E02 and its settings are printed. See "UB-E02 Status Sheet Printing" on page 7 of this chapter.

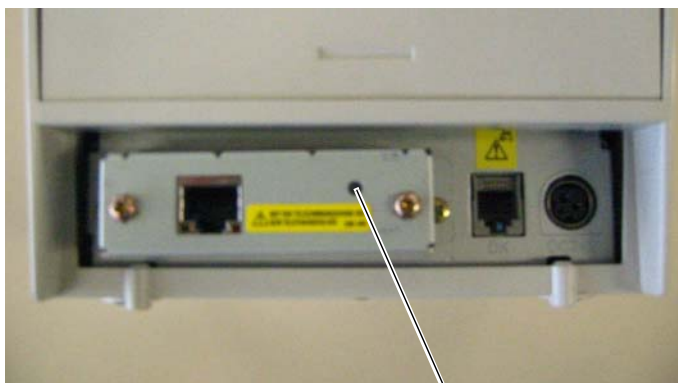

Switch

2.6 Initializing UB-E02

All the parameters of internal settings for the UB-E02 can be set to the factory default values. Follow the steps below:

1. Turn off the printer power. Be sure to confirm that the LED lights are off.
2. Turn on the printer power while pressing the switch of the UB-E02 and hold the switch until the factory default values are printed.
3. After "Resetting to Factory Default!" is printed, release the switch.
4. Initialization takes approximately 30 seconds. Do not turn off the printer power during the initialization.
5. When the initialization is finished, the status sheet is printed. The following are printed on the status sheet.
 - TCP/IP settings
 - SNMP settings
 - MAC address and version of UB-E02
 - Other status items of UB-E02



CAUTION:

Do not turn off the printer power until the status sheet is printed out.

2.7 UB-E02 Status Sheet Printing

The internal setting parameters of the UB-E02 can be printed. Follow the steps below:

1. Confirm that the printer power is on and the printer is ready for printing.
2. Press the switch of the UB-E02 and hold the switch more than 3 seconds.
3. After the status sheet printing starts, release the switch.

2.8 FAQ

2.8.1 Q1. The printer does not operate correctly. ("Serial interface" is printed by the self test for the printer.)

2.8.1.1 A1. For TM-T90, TM-L90, TM-J2000, TM-J2100, TM-J7000, TM-J7100, TM-J7500, and TM-J7600, set the #25 pin reset signal of the Memory switch set to disabled. For other models, use the printer with the #31 pin reset signal of the DIP switch for parallel interface enabled.

Model	Setting
TM-U200 Series	DIP SW 2-8: ON
TM-U210 Series	DIP SW 2-8: ON
TM-U220 Series (STD) *1	DIP SW2-8: ON
TM-U220 Series (US) *1	DIP SW2-4: ON
TM-U230 Series	DIP SW 2-4: ON
TM-U325 Series	DIP SW 2-8: ON
TM-U590 Series	DIP SW 2-8: ON
TM-U675 Series	DIP SW 2-8: ON
TM-T88/T88II/T88III	DIP SW 2-8: ON
TM-T90	MSW 1-8: ON
TM-H5000/H5000II	DIP SW 2-8: ON
TM-H6000/H6000II	DIP SW 2-8: ON
TM-J7000/J7100	MSW 1-8: ON
TM-J7500/J7600	MSW 1-8: ON
TM-J2000/J2100	MSW 1-8: ON
TM-L90	MSW 1-8: ON

*1 TM-U220 has two DIP switch pattern. See TM-U220 Technical Reference Guide for detail.

2.8.2 Q2. The self test does not operate correctly.

2.8.2.1 A2. Turn on the printer power while pressing the FEED button and hold the Feed button until printing starts to perform the self test for the printer with the UB-E02. Printing starts in approximately 6 seconds when the IP address is fixed or approximately 13 seconds when the IP address is acquired by auto setting. (It can be longer, depending on the reply time of the host.)

2.8.3 Q3. Starting up the printer takes a long time.

2.8.3.1 A3. When the auto setting is set for IP address acquisition without a DHCP server, starting up the printer takes about one minute. During this time, the self test for the printer is not performed. Set the manual setting for IP address acquisition where the DHCP server is not available.

Chapter 3

Utilities

3.1 Setting the IP Address

To use the UB-E02 with TCP/IP, you first need to set its IP address. You can set the IP address by using the EPSON TMNet WinConfig or arp/ping command.

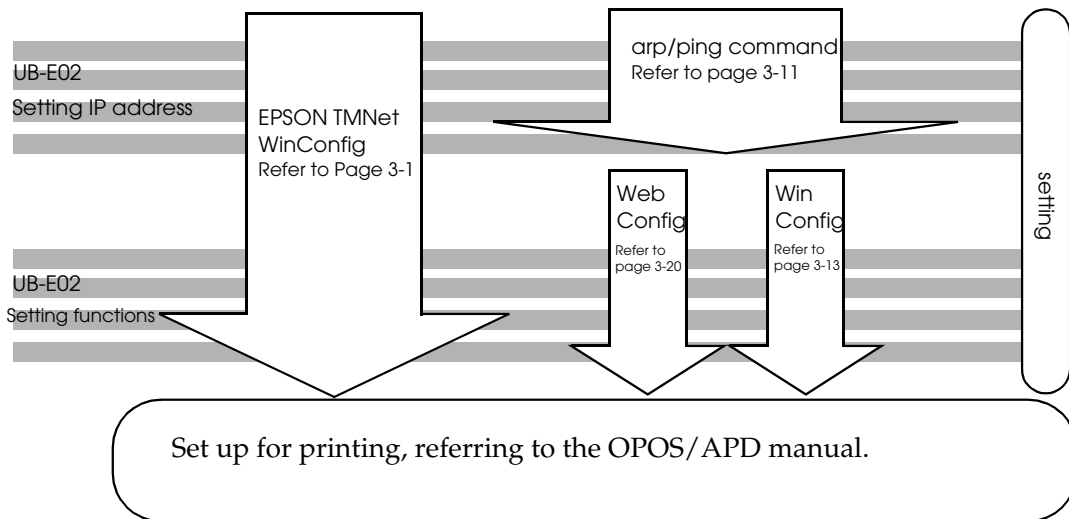

3.1.1 Setting the IP Address using EPSON TMNet WinConfig

Follow the steps below.

1. Set the TCP/IP of your operating system.
2. Install the EPSON TMNet WinConfig.
3. Set the IP address using EPSON TMNet WinConfig.

3.1.1.1 Setting the TCP/IP protocol in Your Operating System

To set the IP address, you need to install the TCP/IP protocol in your operating system. How to set the TCP/IP protocol is explained for Windows 95, Windows 2000, and Windows NT 4.0.

Windows 95

1. Double-click the Network icon in the Control Panel; then check whether TCP/IP is in the list of installed network components on the Configuration menu. If it is already installed, click Cancel and skip to the Installing TMNet WinConfig section. If TCP/IP is not in the list, click Add.

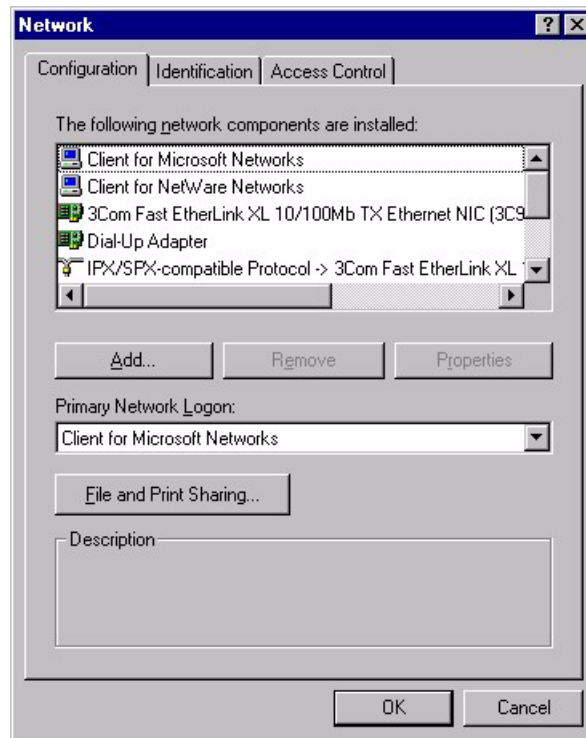

2. Select Protocol and click Add.

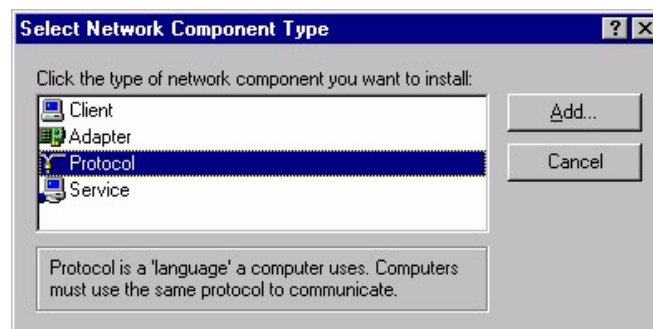

3. Select Microsoft from the list of manufacturers and TCP/IP from the Network protocols list. Then click OK.

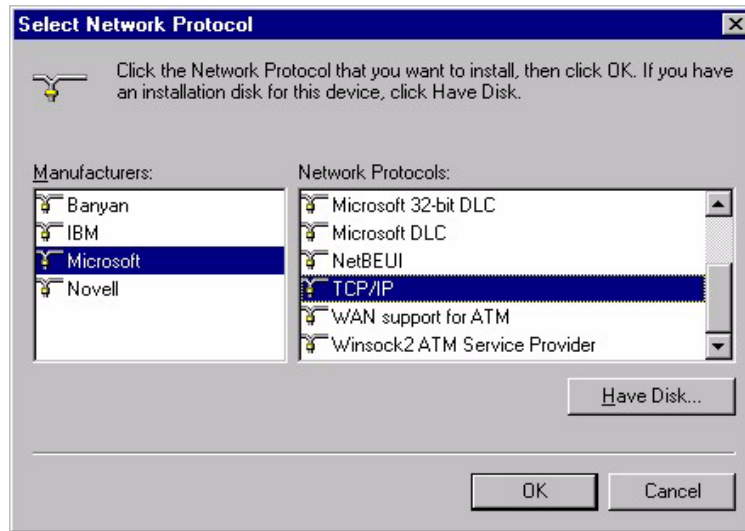

4. Double-click TCP/IP on the Configuration menu to open the TCP/IP Properties dialog box. Make necessary settings, such as the IP address and subnet mask. Ask your network administrator for the settings such as the IP address.

 **Note:**

After the TCP/IP is installed, restart your computer and move on to the Installing EPSON TMNet WinConfig section.

Windows NT 4.0

1. Double-click the Network icon in the Control Panel to check whether the TCP/IP Protocol is installed. If it is already installed, click **Cancel** and skip to the Installing TMNet WinConfig section. If the component is not installed, click **Add**.

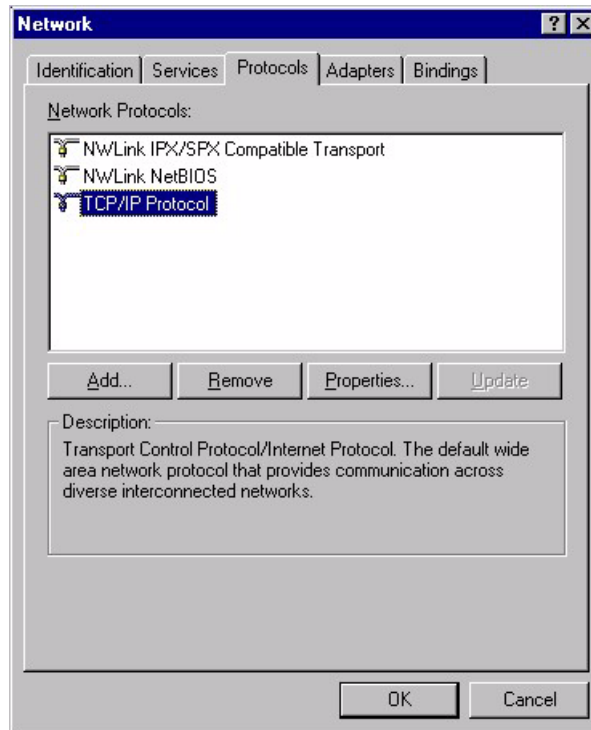

2. Select the TCP/IP protocol and click **OK**.

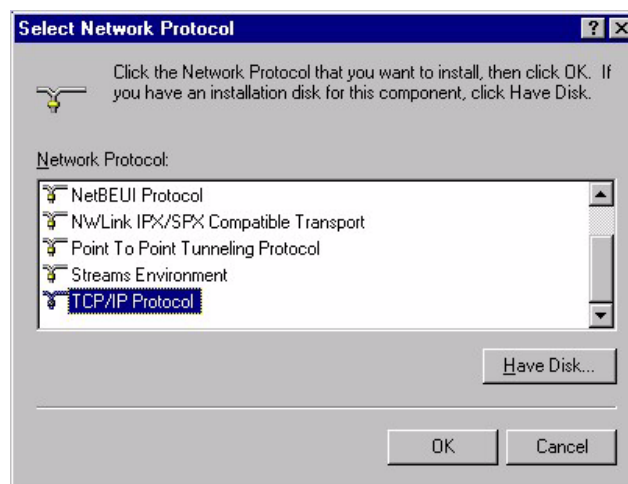

3. If you continue installing the TCP/IP protocol, the TCP/IP Configuration dialog box appears, and you can set the IP address. Ask your network administrator for your IP address.



Note:

To check the IP address which has already been assigned, click the Protocols tab in the Network dialog box, select TCP/IP Protocol, and then click the Properties button.

4. When the installation is complete, check items such as the IP address to make sure they have been entered correctly.



Note:

After the TCP/IP is installed, restart your computer and move on to the Installing EPSON TMNet WinConfig section.

Windows 2000

1. Double-click the Network and Dial Set Up icon in the Control Panel; then click Local Area Connection Status.

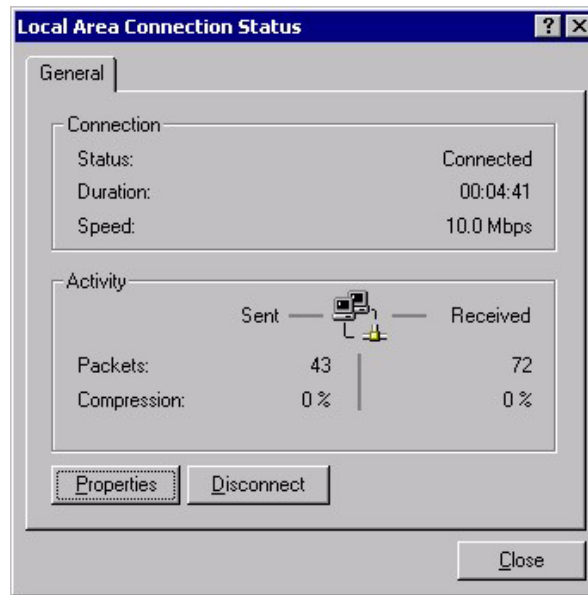

2. Click Properties and check whether the Internet Protocol (TCP/IP) check box is checked. If not, click the check box.

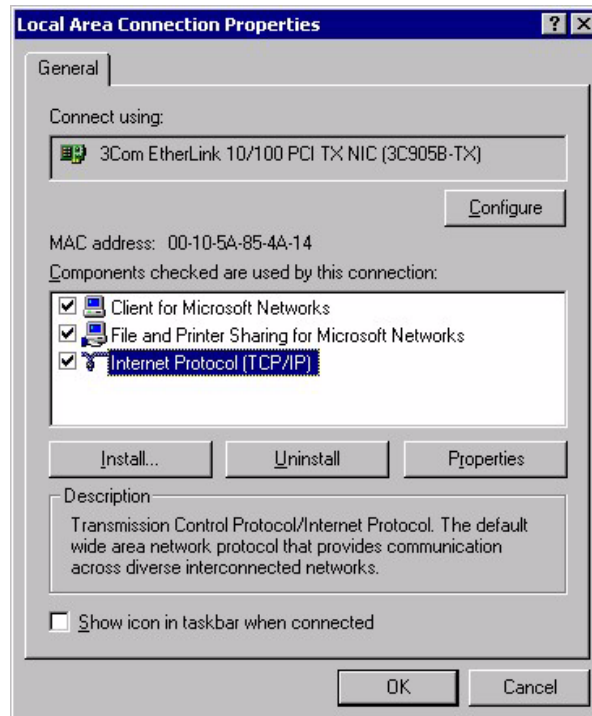

Note:

After the TCP/IP is installed, restart your computer and move on to the Installing EPSON TMNet WinConfig section.

3.1.1.2 Installing EPSON TMNet WinConfig



Note:

After the EPSON TMNet WinConfig is installed, if you add or remove protocols or services, the EPSON TMNet WinConfig might not work correctly. In this case, uninstall the EPSON TMNet WinConfig and reinstall it.

Please contact the dealer where you purchased the product to ask for the EPSON TMNet WinConfig utility.

Installation Environments

Your computer should meet the following conditions:

- The hard disk must have unused memory of 3 MB or more.
- The operating system must be one of the following:
Windows 95, Windows 98 Second Edition, Windows 2000 Professional,
Windows XP Professional, Windows NT 4.0.
- IBM PC/AT compatible with the operating systems mentioned above.

Installation with Windows 95

1. Unzip the file and start Setup.exe.
2. Install the EPSON TMNet WinConfig, following the instructions shown on your display.



3. When the installation is finished, click a check box, if necessary and then click Finish.

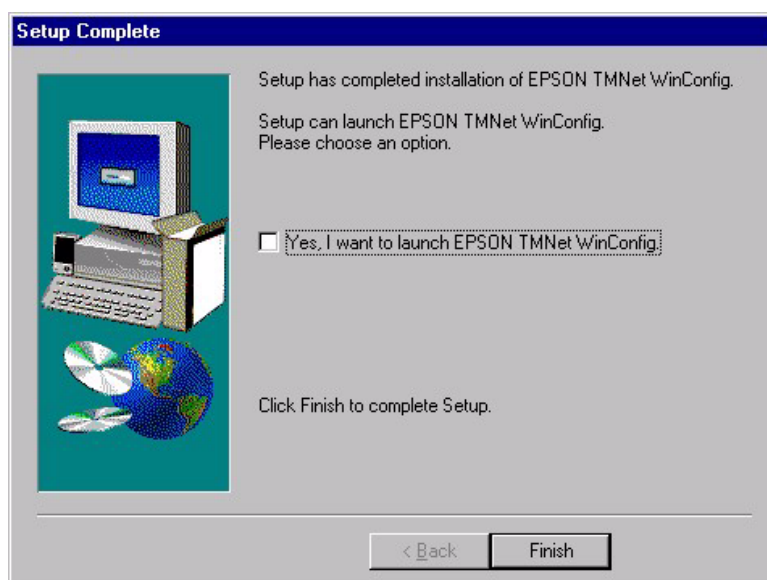

3.1.1.3 Setting with the EPSON TMNet WinConfig

CAUTION:

Because the same IP address is set for all UB-E02 units in the factory, do not connect more than one UB-E02 whose IP address is not changed from the factory setting. When you set the IP address, connect the UB-E02 to the network and set the IP address one by one.

Be sure not to turn off the printer or send printing data to the printer while setting. Do not use the same IP address as that of other network devices or PCs.

Windows 95

1. Make sure Windows is running, the UB-E02 is connected to the network, and the printer is turned on.
2. Click Start, point to Programs, point to EPSON TMNet WinConfig; then click EPSON TMNet WinConfig.
3. Click the printer where you want to set the IP address, and then click the Configuration button. (You might wait for 10 seconds or more to view the UB-E02 over the network on your screen.)

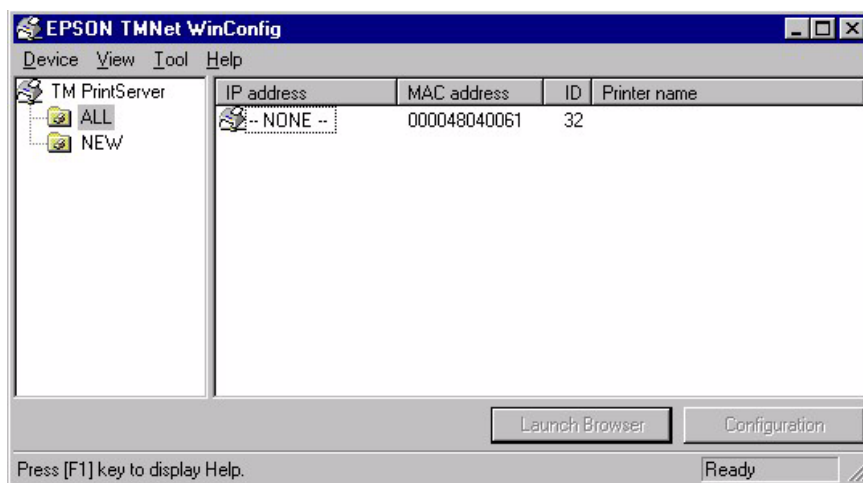

Note:

If you have connected more than one printer to the network and do not know for which printer you want to set the IP address, you can check the printer by finding out the MAC address of the UB-E02. The MAC address can be found on the status sheet or a label on the UB-E02. For printing the status sheet, see "UB-E02 Status Sheet Printing" in Chapter 2.

⚠ CAUTION:

When you cannot check the MAC address on the label on the UB-E02 that is installed on the printer, be sure to finish the TM Net WinConfig by clicking **Close** from the **Device** tab; then turn off the printer and remove the UB-E02 to check it.

4. Double-click the TCP/IP tab.

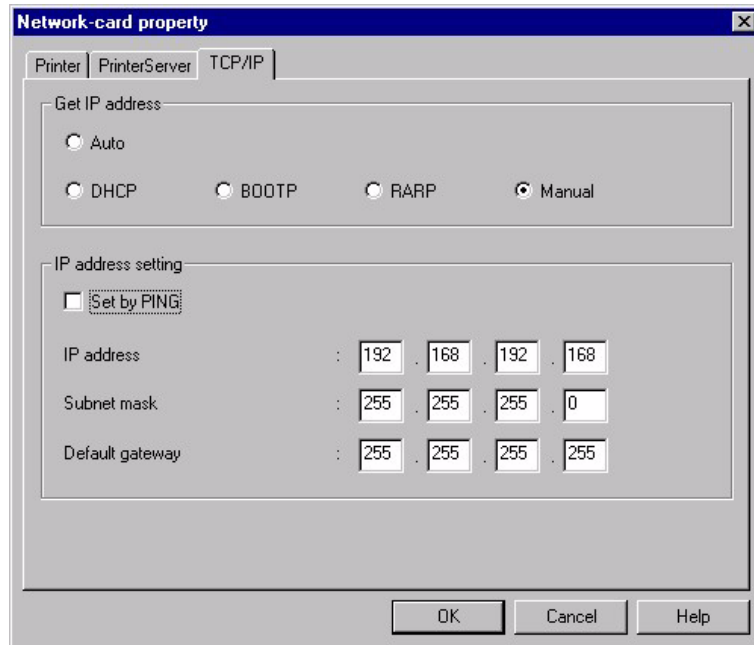

5. You can acquire the IP address by Auto or Manual setting.

- ❑ Auto setting: Acquire the IP address, subnet mask, and default gate way from DHCP server. A DHCP server is required.



Note: Do not use the auto setting without a DHCP server. Refer to the manual of the server for setting.

- ❑ Manual setting: Assign the IP address, the Subnet mask, and the Default gateway. Ask your administrator for the IP address and the Default gateway to be set.

⚠ CAUTION:

Be sure that the Set by PING box is turned on if a setting by ping or arp command is permitted.



Note:

To confirm the current setting, print out the status sheet. Press down the switch more than 3 seconds in the printable state; then the status sheet is printed out.

6. Click the *OK* button.
7. Click the *OK* button again to be sure.

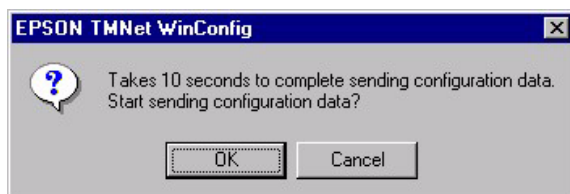

8. Enter the password set in the print server; then click *OK*. If the password is not set, just click *OK* without entering the password.

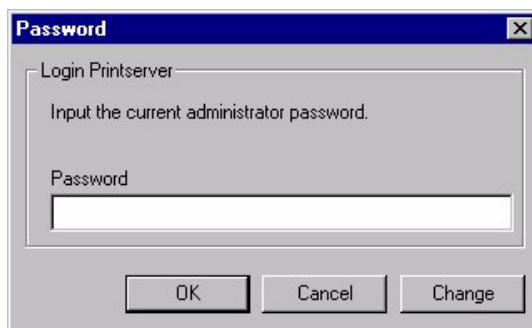

CAUTION:

After clicking *OK*, you must not turn off the printer while the new settings are being sent to the UB-E02.

9. The update is complete when the message “Configuration is successfully done” appears.



Note:

To get the information for the UB-E02 for the other segments, refer to the EPSON TMNet WinConfig Functions section.

3.1.2 Setting the IP Address Using the arp/ping Command

You can set the IP Address using the arp/ping command. This way of setting is available with the host, which is in the same segment as that of the UB-E02.

CAUTION:

When setting the IP address of the UB-E02, do not use the same IP addresses as that of other network devices or PCs.

Here is an example of setting the IP address to 192.168.100.201.

- You will set the gateway address to the computer in which you will input the arp/ping command.
- If a server or router acts as a gateway, type the gateway address.
- If there is no gateway, type the IP address of your computer.
- If you do not know the gateway address, ask your network administrator for it.



Note:

The IP address cannot be set without setting the gateway address.

1. Connect the printer with the UB-E02 installed to the network and turn on the printer.
2. Execute the commands as described in the following steps.



Note:

Be sure to execute the commands within 2 minutes. After 2 minutes, you must restart the commands from the beginning.

3. Make the connection between the IP address which you want to set and the MAC address of the UB-E02 by executing an arp command.
 - From the command line, type: arp-s (IP address) (MAC address)
 Example using DOS: arp-s 192.168.100.201 00-00-48-83-00-00
 Example using UNIX: arp-s 192.168.100.201 00:00:48:83:00:00

CAUTION:

When the UB-E02 is installed on the printer and the MAC address on the label on the UB-E02 cannot be seen for sure, turn off the printer and then remove the UB-E02 to confirm it.



Note:

The MAC address can be found on the status sheet or a label on the UB-E02. For printing the status sheet, refer to the Initializing UB-E02 and Status Sheet Printing section in Chapter 2.

4. Set the IP address to the UB-E02 using the ping command.
 - Example: ping 192.168.100.201
5. If the ping command is successful, the message “Reply From 192.168.100.201: Bytes=32Time<10ms TTL=255” is shown. (The time indication will vary.)
6. Check if the IP address shown is 192.168.100.201.

Now, setting the IP address is complete. Next, set the default gateway and Subnet mask for the UB-E02, referring to the EPSON TMNet WebConfig Functions.

3.2 EPSON TMNet WinConfig Functions

This section describes the functions, including options of the EPSON TMNet WinConfig. The main dialog box is shown below.

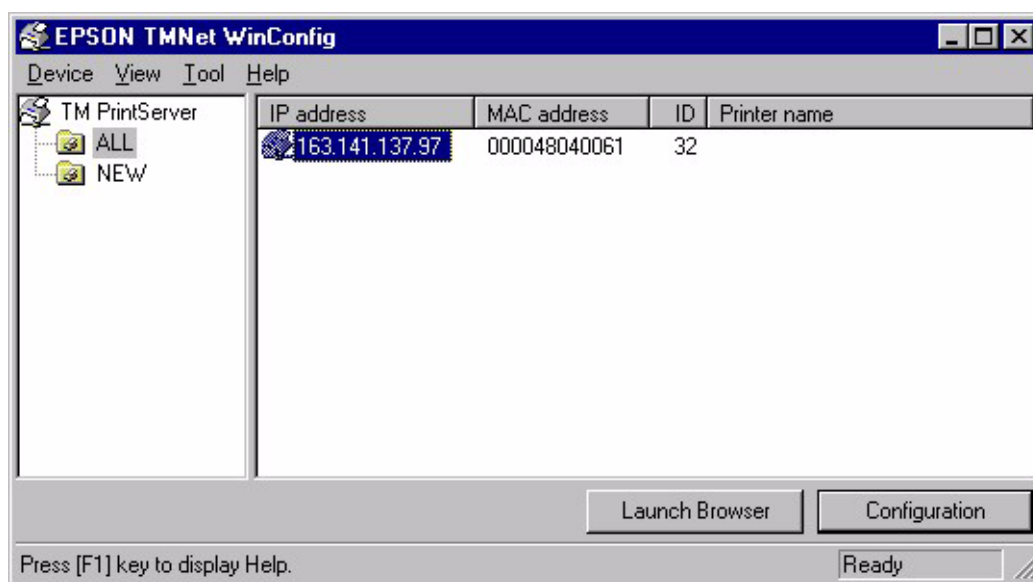

Item	Explanation
Tree view	The tree structure indicates the printer list. It consists of (All), which indicates everything and (NEW), which indicates the printers newly added.
Item	You can change the order by clicking on an item. You can also adjust the viewing size of the item by dragging a dividing line between the items.
List view	Indicates the information for the UB-E02.
Launch Browser	Select the IP address and then click this button. The EPSON WinConfig appears.
Configuration	Select the IP address and then click this button. The setting window of the EPSON WinConfig appears.

3.2.1 Menu Bar

The table shows each item and its function.

Menu	Sub Menus	Explanation
Device	Setting	Start the setting of the UB-E02 selected
	Launch Browser	Start up the TMNet WebConfig
	Close Applications	Close the TMNet WinConfig
Indication	Update	Find the printers and update the list to show the latest information.
Tool	Time-out setting	Set the time-out for data transmission and reception to 2 to 120 seconds.
	Find option	Set the IP find option.
Help	Find the topics	Indicate the TMNet WinConfig help.
	Version information	Indicate version information and copyright information.

3.2.1.1 Tool Menu

Time-out setting

Use Time-out setting to set the time-out for data transmission and reception. This can be set from 2 to 120 seconds. If the time-out exceeds the value set, a communication error occurs.



Search Options

If you want to show and set a UB-E02 that is controlled by TCP/IP and is outside the local network, input the specific address in the Search Options to find that UB-E02.

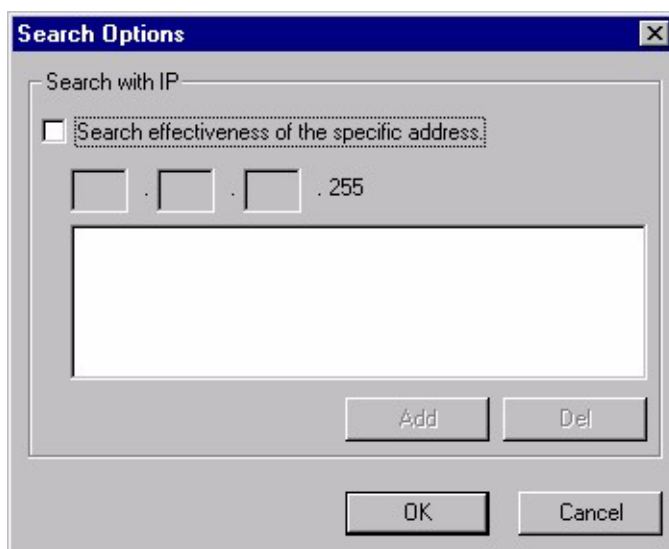

The settings and values stored are effective after executing Update in Indication menu or restarting the EPSON TMNet WinConfig.

Item	Explanation
Enabling a specific address search	Search for the UB-E02 which is outside the network.
IP address	Input an IP address to be searched (0 ~255). Input as follows based on the network classes: Class A: {Input}. (255). (255). (255) Class B: (Input). (Input). (255). (255) Class C: (Input). (Input). (Input). (255)
IP address list	Show the IP addresses that have been registered.
Add	Add to the IP address list. Up to 20 addresses can be added. Do not add the local addresses.
Delete	Delete the IP addresses that will not be used.

3.2.1.2 Settings

Printer

You can set the printer name. This also shows printer information.

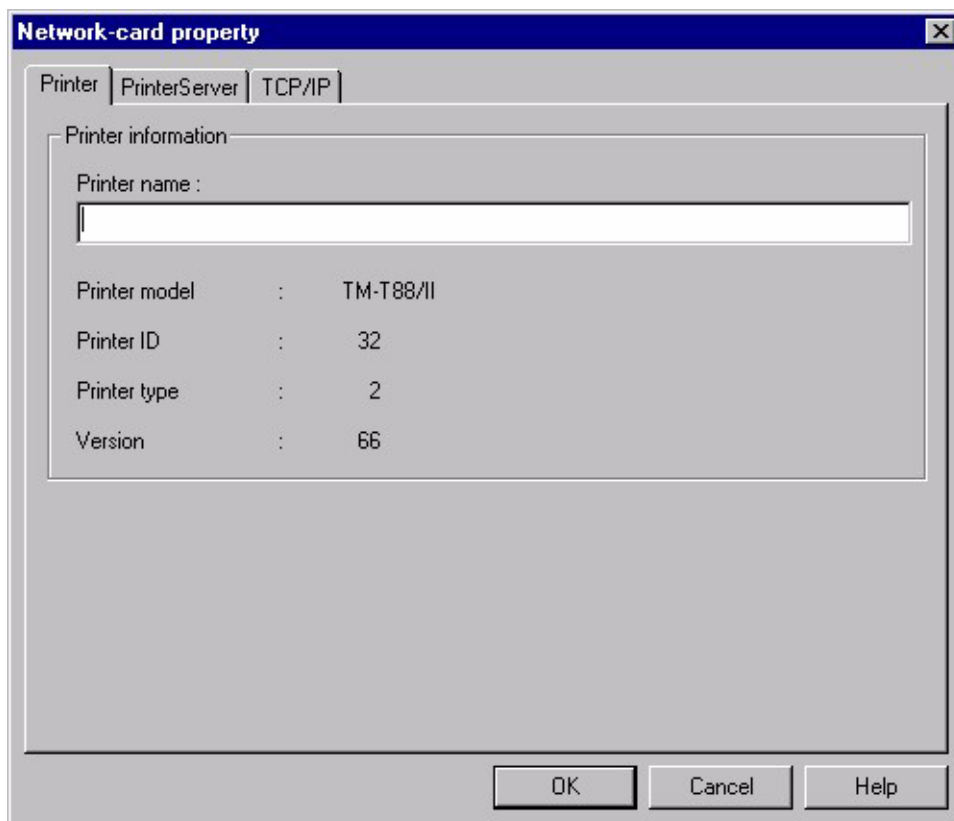

Item	Explanation
Printer name	Set the printer name.
Model name	Shows the printer model name.
Printer ID	Shows the printer ID.
Printer type	Shows the printer type.
Version	Shows the ROM version.

Print server

You can set administrator information. This also shows the printer server information

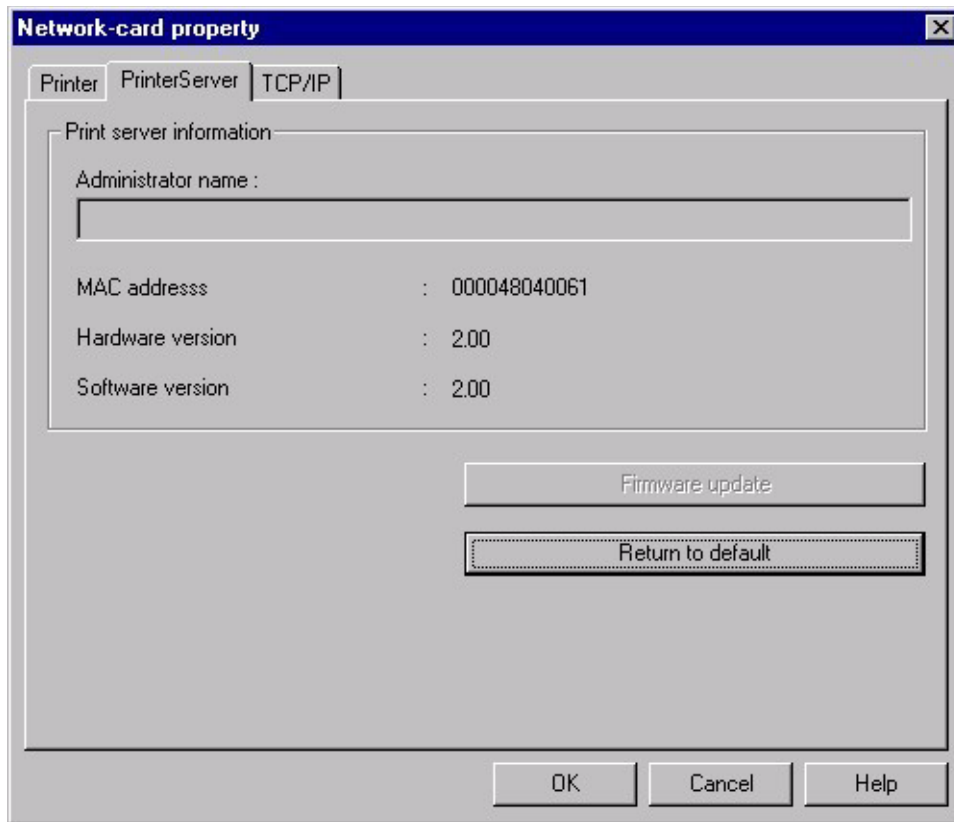

Item	Explanation
Administrator name	Shows the administrator name.
MAC address	Set the administrator name.
Hardware version	Shows the version of the UB-E02.
Software version	Shows the version of the UB-E02.

TCP/IP

You can set the TCP/IP.

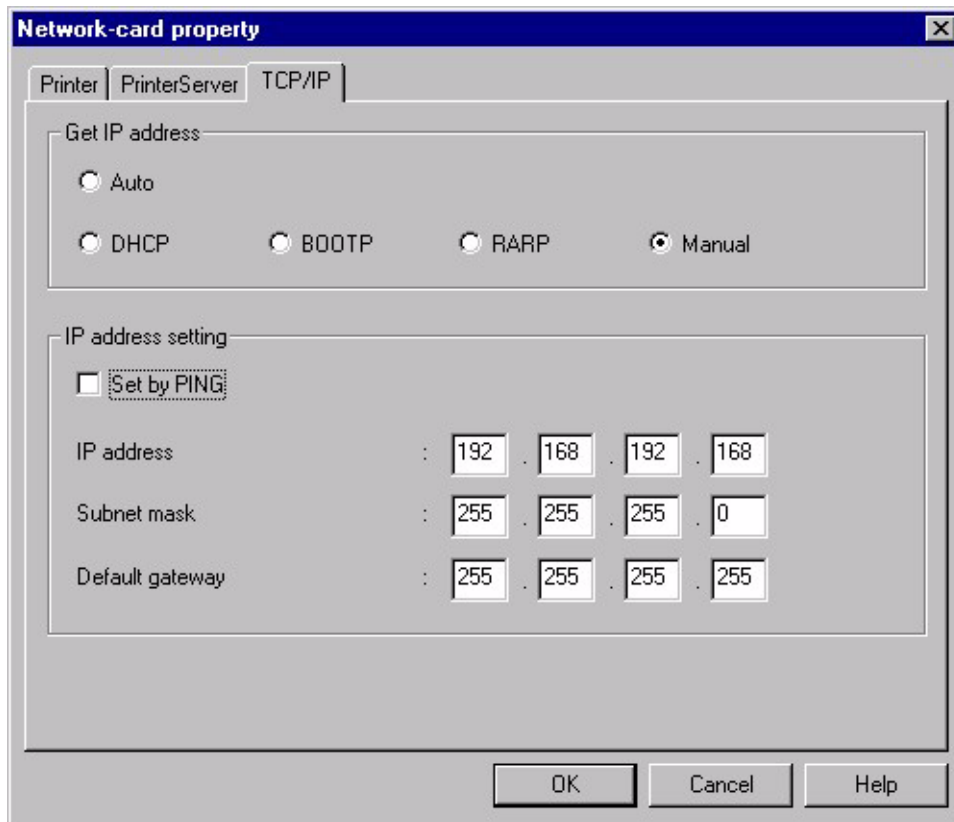

Item	Explanation
Get IP address	Auto or Manual is selectable for the UB-E02.
Set by PING	Check the box if the setting of the UB-E02 by arg/ping is permitted.
Subnet mask	Set the subnet mask of the IP address.
Default gateway	Set the gateway.
IP address	Set the IP address for the UB-E02.

Password

The EPSON TMNet WinConfig can set a password to protect the UB-E02 settings. The screen shown below appears when you click OK or Return to Default.



- ❑ When you set the password the first time or you change the password, click the Change button. No password is registered until you set one.
- ❑ When you click the Change button, the screen shown below appears. Input the password (up to 20 single-byte alphanumeric characters) and then click OK. Capital and lower-case characters are distinguished.



CAUTION:

The password is used for both the EPSON TMNet WinConfig and the EPSON TMNet Web Config. When you use either utility, be sure to control the password.

The new password is effective after clicking the OK button to send the configuration data. Right after the setting, using the Administrator password, input the current password.

If you forget your password, you need to return all settings to the default settings. Refer to the Initializing UB-E02 and Status Sheet Printing section in Chapter 2.

3.3 EPSON TMNet WebConfig Functions

This section explains each function of the EPSON TMNet WebConfig.



Note:

Launch a browser and input the IP address of the UB-E02. Be sure not to launch the EPSON TMNet WinConfig at the same time.

Address: http://(IP address of the UB-E02)/



Note:

Be sure to use Microsoft Internet Explorer 5.0 or later.

3.3.1 Opening Screen

General Information

Administrator Name
Location / Person

Interface Card

Model Name	UB-E02
MAC Address	0000481801CB
Software Version	02.00
Hardware Version	02.00

Printer

Printer ID	32
Printer Status	Online

Refresh

Item		Explanation
Information	General	Show the UB-E02 information.
	TCP/IP	Show the TCP/IP information of the UB-E02.
	SNMP	Show the SNMP information of the UB-E02.
Configuration Network	TCP/IP	Set the TCP/IP of the UB-E02.
	Community	Set the community.
	IP Trap 1	Set the IP trap 1.
	IP Trap 2	Set the IP trap 2.
Configuration Option	Administrator	Set the banner on the opening screen.
	Password	Set the password to protect the network settings.
	Reset	Reset the UB-E02 or return to the factory default setting.
	Advanced	Set communication method.

3.3.2 Protocol Information and Settings

3.3.2.1 General Information

General Information

Administrator Name
Location / Person

Interface Card

Model Name UB-E02
MAC Address 0000481801CB
Software Version 02.00
Hardware Version 02.00

Printer

Printer ID 32
Printer Status Online

Refresh

Item		Explanation
	Administrator name	Shows the administrator name.
	Location/Person	Shows the location or user name.
Interface card	Model name	Shows the name of the interface card.
	MAC address	Shows the MAC address of the UB-E02.
	Software version	Shows the software version of the UB-E02.
	Hardware version	Shows the hardware version of the UB-E02.
Printer	Printer ID	Shows the printer ID.
	Printer status	Shows the printer status.

3.3.2.2 TCP/IP Information

The screenshot shows the 'TCP/IP Information' page in the Epson TMNet WebConfig utility. On the left is a navigation menu with sections for 'Information' (General, TCP/IP, SNMP) and 'Configuration' (Network: TCP/IP, SNMP, Community, IP Trap 1, IP Trap 2; Option: Administrator, Password, Reset, Advanced). The main area displays the following settings:

Item	Value
Get IP Address	MANUAL
Set using Automatic Private IP Addressing (APIPA)	Disable
Set using PING	Disable
IP Address	192.168.192.168
Subnet Mask	255.255.255.0
Default Gateway	0.0.0.0

Item	Explanation
Get IP Address	Shows the method of setting the IP address.
Set using Automatic Private IP Addressing (APIPA)	Shows the APIPA setting.
Set using PING	Shows the settings of prohibition and permission by the arp/ping command for the UB-E02.
IP Address	Shows the IP address.
Subnet Mask	Shows the subnet mask of the IP address.
Default Gateway	Shows the default gateway.

3.3.2.3 SNMP Information

Information

- ▶ General
- ▶ TCP/IP
- ▶ **SNMP**

Configuration

Network

- ▶ TCP/IP
- ▶ SNMP
 - ▶ **Community**
 - ▶ IP Trap 1
 - ▶ IP Trap 2

Option

- ▶ Administrator
- ▶ Password
- ▶ Reset
- ▶ Advanced

EPSON

SNMP Information

Community

Read Only: public

Read/Write

IP Trap

Trap 1: Disable

Address: 0.0.0.0

Community Name

Trap 2: Disable

Address: 0.0.0.0

Community Name

Item		Explanation
Community	Read Only	Shows the Read Community information.
	Read/Write	Shows the Read/Write Community information.
IP Trap	Trap 1	Shows the Trap 1 information.
	Address	Shows the Trap 1 Address.
	Community Name	Shows the Trap 1 Community Name.
	Trap 2	Shows the Trap 2 information.
	Address	Shows the Trap 2 Address.
	Community Name	Shows the trap 2 Community Name.

3.3.2.4 TCP/IP Setting

TMNet WebConfig **EPSON for POS**

Information

- ▶ General
- ▶ **TCP/IP**
- ▶ SNMP

Configuration

Network

- ▶ **TCP/IP**
- ▶ SNMP
- ▶ Community
- ▶ IP Trap 1
- ▶ IP Trap 2

Option

- ▶ Administrator
- ▶ Password
- ▶ Reset
- ▶ Advanced

EPSON

TCP/IP Setting

Get IP Address

Set using Automatic Private IP Addressing (APIPA)

Set using PING

IP Address

Subnet Mask

Default Gateway

SUBMIT

Item	Explanation
Get IP Address	Select the method of acquiring the IP address.
Set using Automatic Private IP Addressing (APIPA)	Set APIPA able/disable.
Set using PING	Select when the setting of the UB-E02 by arp/ping is permitted.
IP Address	Set the IP address of the UB-E02.
Subnet Mask	Set the subnet mask of the IP address.
Default Gateway	Set the default gateway.

3.3.2.5 SNMP Communication Setting

The screenshot shows the 'SNMP Communication Setting' page in the EPSON TMNet WebConfig utility. The left sidebar is green and contains two main sections: 'Information' and 'Configuration'. Under 'Information', there are links for 'General', 'TCP/IP', and 'SNMP'. Under 'Configuration', there are links for 'Network', 'TCP/IP', 'SNMP', 'Community', 'IP Trap 1', and 'IP Trap 2'. Below these are 'Option' settings for 'Administrator', 'Password', 'Reset', and 'Advanced'. At the bottom of the sidebar is the EPSON logo. The main content area has a dark red header with the title 'SNMP Communication Setting' and a help icon. Below the header, the 'Community' section is visible. It has two rows: 'Read Only' with the value 'public' and 'Read/Write' with an empty text input field. At the bottom of the main content area is a dark red bar with a 'SUBMIT' button.

Item	Explanation	
Community	Read Only	The setting is fixed to "Public."
	Read/Write	Set the Read/Write Community Name (up to 16 characters).

3.3.2.6 SNMP IP Trap 1 Setting

Item	Explanation
Trap	Set Trap 1.
Address	Set the Trap 1 Address.
Community Name	Set the Trap 1 Community Name.

3.3.2.7 SNMP IP Trap 2 Setting

SNMP IP Trap 2 Setting

Trap:

Address:

Community Name:

SUBMIT

Item	Explanation
Trap	Set Trap 2.
Address	Set the Trap 2 Address.
Community Name	Set the Trap 2 Community Name.

3.3.2.8 Administrator Setting

Item	Explanation
Administrator Name	Set the administrator name.
Location/Person	Set the location or user name.

3.3.2.9 Password Setting

The screenshot shows the 'Password Setting' page in the EPSON TMNet WebConfig interface. The sidebar on the left contains the following navigation options:

- Information**
 - General
 - TCP/IP
 - SNMP
- Configuration**
 - Network
 - TCP/IP
 - SNMP
 - Community
 - IP Trap 1
 - IP Trap 2
 - Option
 - Administrator
 - Password**
 - Reset
 - Advanced

The main content area has a red header with the title 'Password Setting' and a help icon. Below the header are three input fields:

- Old Password
- New Password
- Re-input Password

A red bar at the bottom of the main area contains a 'SUBMIT' button.

Item	Explanation
Old Password	Input the old password.
New Password	Input the new password.
Re-input Password	Re-input the new password.

3.3.2.10 Reset

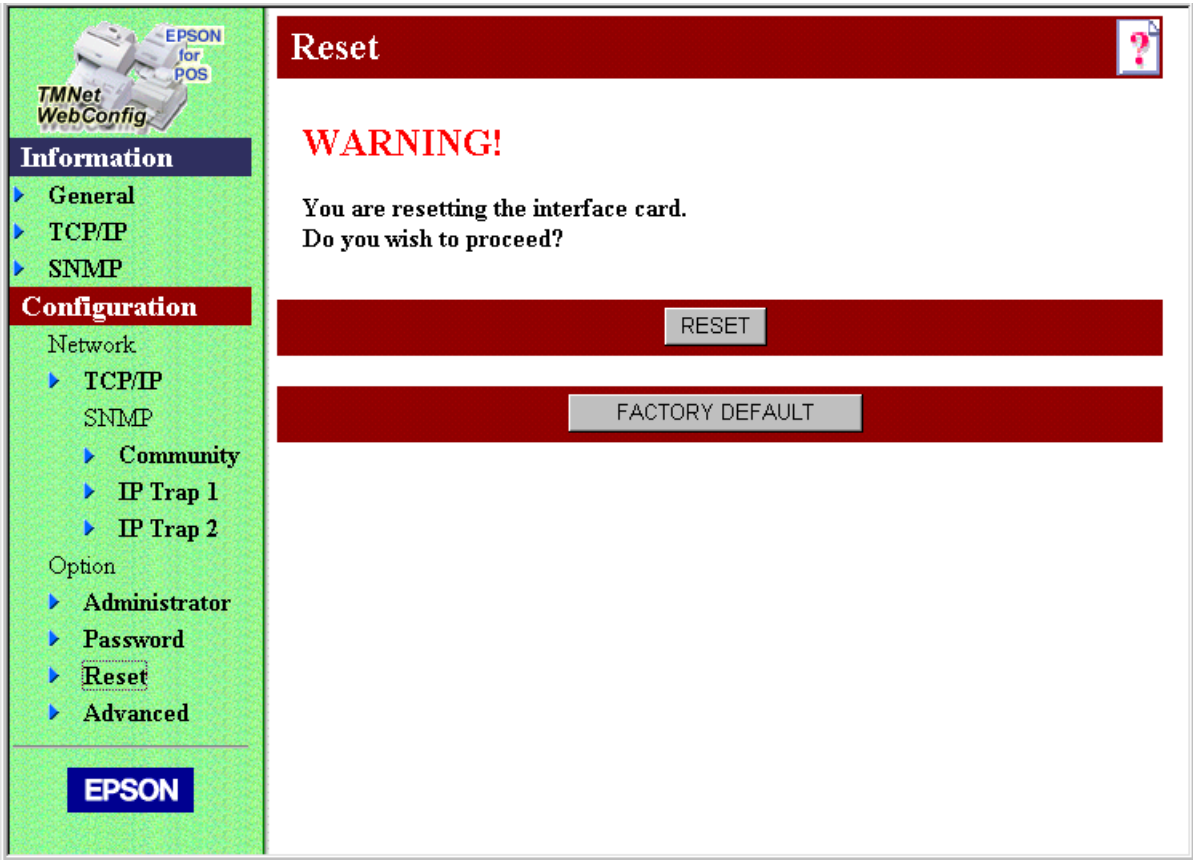

Item	Explanation
Reset	Resets the UB-E02 to its status when the power was turned on.
Factory Default	Returns to the factory default settings.

3.3.2.11 Advanced

The screenshot shows the 'Advanced' configuration page in the EPSON TMNet WebConfig utility. On the left, a green sidebar contains a navigation menu with 'Information' (General, TCP/IP, SNMP) and 'Configuration' (Network: TCP/IP, SNMP, Community, IP Trap 1, IP Trap 2; Option: Administrator, Password, Reset, **Advanced**). The main content area has a dark red header with the word 'Advanced' and a help icon. Below the header, the 'Physical Layer Setting' is displayed as a dropdown menu currently set to 'Auto Negotiate'. A 'SUBMIT' button is located below the dropdown menu.

Item	Explanation
Physical Layer Setting	Set the communication method.

Chapter 4

Programming Samples

This chapter describes the following:

- ❑ Method of printing to the UB-E02
- ❑ Direct printing by PORT9100
- ❑ Commands sent to a TM printer when the power is on
- ❑ Monitoring of the ASB status
- ❑ The rights of printing
- ❑ Time-out for connection
- ❑ Printer operation by UDP commands
 - Command packets
 - 03-0000:retrieving the basic information
 - 03-0010:retrieving the status
 - 03-0011: forced transmission
 - 03-0012: reset
 - 03-0013: buffer flash
 - 03-0016: clearing the connection time-out timer
 - Programming sample

4.1 Method of Printing to the UB-E02

The UB-E02 has lpr protocol as its general print protocol. It is easy to print by using the lpr protocol because the printing is also supported by the operating system.

However, the command statuses sent by the printer are ignored because the printing by lpr applies only to the output of the printer.

The UB-E02 supports direct printing by TCP PORT9100. It is possible to control the printer directly by an application with the ESC/POS commands through writing and reading to the TCP PORT9100.

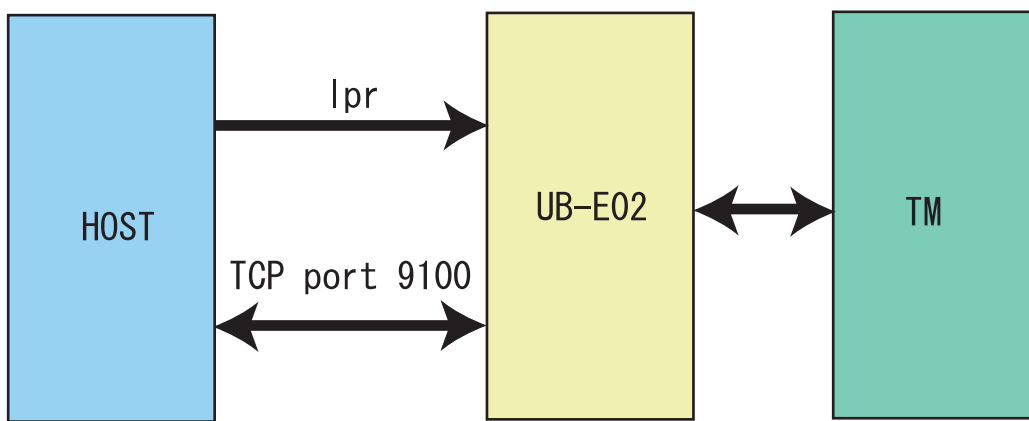

4.1.1 Buffer of the UB-E02

This is an image of the buffer. The buffer sent from the host computer to the TM printer is 16 KB. The buffer sent from the TM printer to the host computer is 512 bytes.

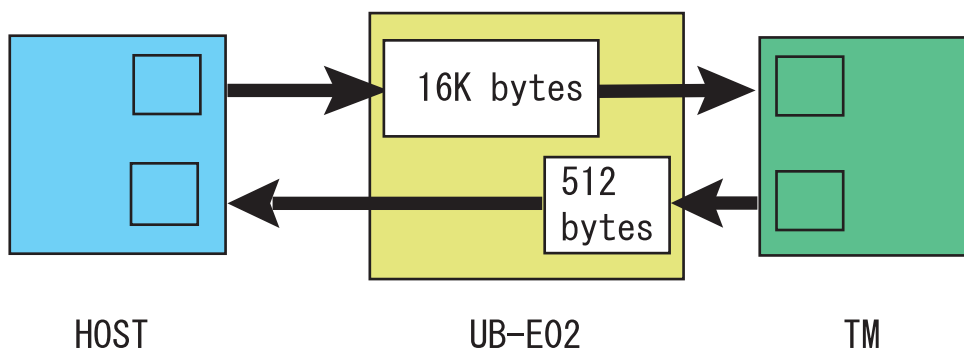

4.2 Direct Printing by PORT9100

4.2.1 For Windows Console

The program is a sample of printing “EPSON UB-E02” to a TM printer with the UB-E02 from the Windows shell, through the ethernet connection.

```

/* TCP9100 programming sample for win32
 * HOW TO BUILD
 *   cl wtcp.cpp wsock32.lib
 */
#include <stdio.h>
#include <winsock.h>

int main(int argc, char* argv[])
{
    WSADATA data;
    SOCKET sock;
    struct linger Linger;
    struct sockaddr_in addr;

    if (argc != 2) {
        printf("usage: wtcp <IP address>\n");
        exit(1);
    }

    /* Initialize windows socket */
    WSStartup(0x0101, &data);

    /* Create socket */
    if ((sock = socket(AF_INET, SOCK_STREAM, 0)) == INVALID_SOCKET) {
        fprintf(stderr, "Error socket(): %d\n", WSAGetLastError());
        exit(1);
    }

    /* Set connection timeout */
    Linger.l_onoff = 1;
    Linger.l_linger = 60;
    setsockopt(sock, SOL_SOCKET, SO_LINGER, (char*)&Linger, sizeof(struct linger));

    /* initialize the parameter */
    memset(&addr, 0, sizeof(addr));
    addr.sin_family = AF_INET;
    addr.sin_port = htons(9100);
    addr.sin_addr.s_addr = inet_addr(argv[1]);

    /* connect */
    if (connect(sock, (struct sockaddr*)&addr, sizeof(addr)) < 0) {
        fprintf(stderr, "Error connect(): %d\n", WSAGetLastError());
        exit(1);
    }
    printf("connected\n");
}

```

```
/* send data */
send(sock, "EPSON\n", 6, 0);

/* gracefully close */
shutdown(sock, 1);/* SD_SEND */
while (1) {
    char buf[64];
    int n = recv(sock, buf, 64, 0);
    if (n == SOCKET_ERROR || n == 0)
        break;
}
shutdown(sock, 2);/* SD_BOTH */

/* close socket */
closesocket(sock);
return 0;
}
```

4.2.2 For Linux

The program is a sample of printing “EPSON UB-E02” to a TM printer with the UB-E02 from Linux, through the ethernet connection.

```
/* TCP00 programming sample for LINUX
 * HOW TO BUILD
 * cc ltcp.c
 */
#include <stdio.h>
#include <netdb.h>

int main(int argc, char* argv[])
{
    int sock;
    struct sockaddr_in addr;

    if (argc != 2) {
        printf("usage: ltcp <ip address>\n");
        exit(1);
    }

    /* create socket */
    sock = socket(AF_INET, SOCK_STREAM, 0);
    if (sock < 0) {
        perror("socket()");
        exit(1);
    }

    /* initialize the parameter */
    memset(&addr, 0, sizeof(addr));
    addr.sin_family = AF_INET;
    addr.sin_port = htons(9100);
    addr.sin_addr.s_addr = inet_addr(argv[1]);

    /* connect */
    if (connect(sock, (struct sockaddr*)&addr, sizeof(addr)) < 0) {
        perror("connect()");
    }
    printf("connected\n");

    /* send data */
    send(sock, "EPSON\n", 6, 0);

    /* close socket */
    close(sock);

    return 0;
}
```

4.3 Commands Sent to a TM Printer When the Power is On

When the power is turned on, the UB-E02 transmits the following commands to the TM printer and maintains the statuses. The UB-E02 acquires printer information by **GS I** and monitors the printer status through the TMNet WebConfig using the **GS a 255** command.

ESC/POC command descriptions:

- **GS I 1**: printer ID
- **GS I 2**: printer type ID
- **GS I 3**: printer ROM version ID
- **GS a FFh**: Enables ASB status

Note:

When the power is turned off or the printer is off-line, the commands above are not transmitted.

4.4 Monitoring of the ASB status

The UB-E02 monitors the ASB statuses transmitted from TM printers to control the printer statuses from host computers. The printer can know the statuses by remote using the TMNet WinConfig or the TMNet WebConfig.

If the printing data includes commands that disable the ASB such as **ESC @** and **GS a 00h**, the ASB status from the TM printer will not be transmitted afterward when the printer status is changed and the UB-E02 cannot monitor the status of the TM printer.

To monitor the printer status, when there is a command that disables the ASB in a data string sent by an application to the TM printer, transmit a command that enables the ASB.

4.5 The Priorities of Printing

The UB-E02 permits up to 3 requests of connecting regardless of the lpr/port9100 protocol. Printing by the TM printer is given the first priority. Data transmission is blocked for other requests until the first connection is closed (explicit close or close by time-out).

4.6 Time-out for Connection

If there is no data transmitted from the host for 5 minutes, regardless of the protocol, lpr/port9100, the UB-E02 closes the connection. To continue the connection, the host needs to send the UDP command explicitly.

4.7 Printer Operation by the UDP Commands

By using the UDP commands, the following information can be received in order to recover from abnormal operations and errors.

Function Code	Packet	Function
03-0000	Q	Acquires basic information
03-0010	Q	Acquires status
03-0011	C	Off-line forced transmission
03-0012	C	Reset
03-0013	C	Buffer flash
03-0016	C	Clears connection time-out timer

4.7.1 Commands Packets

Off-set	Size	Packet Transmission	Packet Reply
0	5	Character string "EPSON"	Character string "EPSON"
5	1	Packet type: 'Q': Query 'C': Command	Packet type reply: 'q': Query reply 'c': Command reply
6	1	Device type (0 × 03 fixed)	Device type (0 × 03 fixed)
7	1	Device number (0 × 00 fixed)	Device number (0 × 00 fixed)
8	2	Function number	Function number
10	2	0 × 00, 0 × 00 fixed	Result code
12	2	Length (n)	Length (n)
14	n	Command parameter	Reply data

The following values are replied for the packet reply result codes. Check the results in an application.

- 0000h: Normal end
- FFFEh: No device requested
- FFFFh: Function requested are not supported

4.7.2 03-0000 Retrieving Basic Information

4.7.2.1 Reply data

Off-set	Size	Description
14	1	Interface type
15	1	Communication method with TM printer
16	1	Printer ID acquired during a power-on
17	1	Printer type ID acquired during a power-on
18	1	Printer ROM version acquired during a power-on
19	n	Printer name character string (128 bytes)

4.7.3 03-0010 Retrieving Status

4.7.3.1 Reply data

Off-set	Size	Description
14	1	Reserved
15	4	ASB
19	4	ASB for Ink
23	4	ASB for optional functions

4.7.4 03-0011 Forced Transmission

Transmission is done, regardless of the flow control between the TM printer and the UB-E02.

4.7.4.1 Set-up data

Off-set	Size	Description
14	1	Flow control 0: With flow control 1: No flow control (forced transmission)
15	2	Data length (n: maximum: 255)
17	n	Data length (maximum: 255)

4.7.4.2 Reply data

Off-set	Size	Description
14	1	Result 0: Normal Except for 0: Failure
15	2	Data length
17	n	Data string

4.7.5 03-0012 Reset

4.7.5.1 Set-up data

Off-set	Size	Description
14	1	Reserved (undefined)

4.7.5.2 Reply data

Off-set	Size	Description
14	1	Result 0: Normal Except for 0: Failure

- To reset the printer, the reset function should be enabled by a DIP switch of the printer.
- The UB-E02 is also reset when the printer is reset.
- After resetting, wait for approximately 10 seconds before accessing to the UB-E02, which is the same as when turning on the power.

4.7.6 03-0013 Buffer Flash

4.7.6.1 Reply data

Off-set	Size	Description
14	1	Result 0: Normal Except for 0: Failure

- ❑ This clears only the buffer of the UB-E02 and cannot clear the receive buffer of the printer.

4.7.7 03-0016 Clearing Connection Time-Out Timer

Regularly send commands clearing the connection time-out timer to avoid time-out when data is not sent for a certain period of time.

4.7.7.1 Set-up data

None

4.7.7.2 Reply data

Off-set	Size	Description
14	1	Result 0: Normal Except for 0: Failure

4.7.8 Programming Sample

4.7.8.1 For Windows Console

```

/* UDP3289 programming sample for win32
 * HOW TO BUILD
 * cc wudp.cpp wsock32.lib
 */
#include <stdio.h>
#include <winsock.h>

#define MAXBUF 512
char buf[MAXBUF];

int main(int argc, char* argv[])
{
    WSADATA data;
    SOCKET sock;
    struct sockaddr_in addr;
    int i, len, fromlen;

    if (argc != 2) {
        printf("usage: wudp <IP address>\n");
        exit(1);
    }

    /* initialize windows socket */
    WSStartup(0x0101, &data);

    /* Create socket */
    if ((sock = socket(AF_INET, SOCK_DGRAM, 0)) == INVALID_SOCKET) {
        fprintf(stderr, "Error socket(): %d\n", WSAGetLastError());
        exit(1);
    }

    /* initialize the parameter */
    memset(&addr, 0, sizeof(addr));
    addr.sin_family = AF_INET;
    addr.sin_port = htons(3289);
    addr.sin_addr.s_addr = inet_addr(argv[1]);

    /* make a packet (PRINTER STATUS) */
    buf[0] = 'E';
    buf[1] = 'P';
    buf[2] = 'S';
    buf[3] = 'O';
    buf[4] = 'N';
    buf[5] = 'Q'; // PacketType(Q)
    buf[6] = 0x03; // DeviceType(3)
    buf[7] = 0x00; // DeviceNumber(0)
    buf[8] = 0x00; // Function(0010h)
    buf[9] = 0x10;

    buf[10] = 0x00; // Result

```

```
buf[11] = 0x00;
buf[12] = 0x00; // Parameter length
buf[13] = 0x00;

/* send a packet */
i = sendto(sock, buf, 14, 0, (struct sockaddr*)&addr, sizeof(addr));

/* receive packet */
fromlen = sizeof(addr);
len = recvfrom(sock, buf, MAXBUF, 0, (struct sockaddr*)&addr, &fromlen);

/* print receive packet */
if (len) {
    if ((buf[10] == 0x00) && (buf[11] == 0x00))
        for (i = 0; i < len; i++)
            printf("%3d:%02Xh\n", i, buf[i] & 0xff);
}

/* close socket */
closesocket(sock);
return 0;
}
```

4.7.8.2 For Linux

```

/* UDP3289 programming sample for LINUX
 * HOW TO BUILD
 * cc ludp.c
 */
#include <stdio.h>
#include <netdb.h>

#define MAXBUF 512
char buf[MAXBUF];

int main(int argc, char* argv[])
{
    int sock;
    struct sockaddr_in addr;
    int i, len;
    socklen_t fromlen;

    if (argc != 2) {
        printf("usage: udp3289 IP_ADDRESS\n");
        exit(1);
    }

    /* create sockets */
    sock = socket(AF_INET, SOCK_DGRAM, 0);
    if (sock < 0) {
        perror("socket()");
        exit(1);
    }

    /* initialize the parameter */
    memset(&addr, 0, sizeof(addr));
    addr.sin_family = AF_INET;
    addr.sin_port = htons(3289);
    addr.sin_addr.s_addr = inet_addr(argv[1]);

    /* make a packet (PRINTER STATUS) */
    buf[0] = 'E';
    buf[1] = 'P';
    buf[2] = 'S';
    buf[3] = 'O';
    buf[4] = 'N';
    buf[5] = 'Q'; // PacketType (Q)
    buf[6] = 0x03; // DeviceType(3)
    buf[7] = 0x00; // DeviceNumber(0)
    buf[8] = 0x00; // Function(0010h)
    buf[9] = 0x10;
    buf[10] = 0x00; // Result
    buf[11] = 0x00;

    buf[12] = 0x00; // parameter length Length

```

```
buf[13] = 0x00;

/* send packet */
i = sendto(sock, buf, 14, 0, (struct sockaddr*)&addr, sizeof(addr));

/* receive packet */
fromlen = sizeof(addr);
len = recvfrom(sock, buf, MAXBUF, 0, (struct sockaddr*)&addr, &fromlen);

/* print receive packet */
if (len) {
    if ((buf[10] == 0x00) && (buf[11] == 0x00))
        for (i = 0; i < len; i++)
            printf("%3d:%02Xh\n", i, buf[i] & 0xff);
}

/* close socket */
close(sock);
return 0;
}
```

Chapter 5

Specifications

The UB-E02 can be installed in the TM-series printers as an interface board to provide 10 Base-T/100 Base-TX communications.

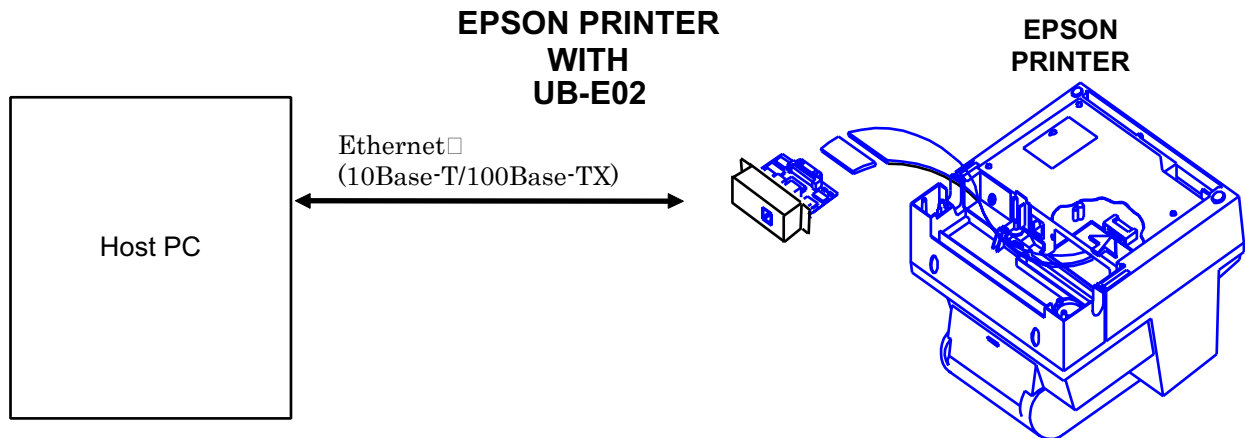

5.1 Printer Connection

The interface board can be installed in TM-series printers that support the universal interface board system.

5.2 Line Display Connection

When the UB-E02 is connected, the DM connector on the TM unit cannot be used. Refer to the Supported TM Printers section in Chapter 1.

5.3 Features

5.3.1 Overview

- ❑ 10 Base-T/100 Base TX Ethernet
- ❑ Complies with TCP/IP protocol (LP, LPR, and socket communications)
- ❑ The interface board system can be connected to a variety of TM printers with the universal interface
- ❑ Board size: 70 × 58 mm {2.76 × 2.28"}

5.3.2 Printing Functions

- ❑ Printing by standard protocols (printing of network objects through a device driver)
- ❑ Socket printing by unique socket communications (port 9100 for OPOS)
- ❑ Supports OPOS/Unimini/JavaPOS

5.3.3 Functions to Monitor Settings

- ❑ Various settings and states displayed by Web browser
- ❑ IP address setting by arp + ping
- ❑ Supports DHCP
- ❑ Supports APIPA
- ❑ ping response
- ❑ Status printing function
- ❑ Module setting initialization using the Test switch
- ❑ Status monitoring by ENPC
- ❑ Status monitoring by SNMP

5.3.4 Maintenance Functions

- ❑ Firmware writing through the network

5.4 Hardware Specifications

5.4.1 Physical communications standard

10 Base-T/100 Base-TX (IEEE 802.3)

5.4.2 Board size

70 × 58 mm {2.76 × 2.28"}

5.5.3 Status Inquiry and Setting Protocols

Protocol	Application
HTTP	Display module status and make settings by Web browser.
SNMP	Acquire and set module settings or printer status by custom or general purpose MIB tool.
ENPC	Acquire and set module settings or printer status by custom setup utility.

5.5.3.1 HTTP

- Port number: 80
- User name: EPSON
- Password: None
- Maximum simultaneous connections: 1
- HTTP version: HTTP/1.1

5.5.3.2 SNMP (MIB)

Terminology:

MIB: Management Information Base

PDU: Protocol Data Unit

- SNMP version: SNMP v1 (RFC1157) compliant
SNMP v2 not supported
- Transport protocol: UDP/IP
- Community Each item may be up to 16 ASCII characters

Community	Object Attribute	Default
#1	Read-only	"Public"
#2	Read-write	None
Trap #1	Read-write	None
Trap #2	Read-write	None

- Trap destination Up to two settable IP addresses
- MIB support
Part of MIB-II (RFC1213)
Part of Host Resource MIB
Part of Print Server MIB
Part of Printer MIB

- ❑ PDU support
 - Get Request
 - Get Next Request
 - Set Request
 - Get Response
 - Trap
- ❑ Server port number 161
- ❑ Trap sending port number 162

5.5.3.3 ENPC

- ❑ Protocol: UDP/IP
- ❑ UDP port number: 3289
- ❑ Compatible packet types:
 - Probe
 - Initialize
 - Query
 - Setup
 - Notify

5.5.4 Automatic IP Address Assignment Protocols

The UB-E02 supports the DHCP and APIPA protocols for automatic IP address assignment. The automatic assignment is performed according to the following sequence, and if a protocol is disabled or fails, the next protocol is tried. When an IP address is acquired, the next protocol is not tried.

Protocol	Sequence	Application
DHCP	1	Acquires IP address
APIPA	2	Assigns IP address
manual setting	3	Uses the internal set parameters

5.5.4.1 IP Address Acquisition by DHCP

- ❑ Items to acquire: IP address, subnet mask, gateway address
- ❑ DHCP Discover retries: 4 times
- ❑ DHCP Discover retry interval:

1st: 4 seconds	2nd: 7 seconds
3rd: 15 seconds	4th: 32 seconds
- ❑ DHCP Request retries: 10 times
- ❑ DHCP Request retry interval: 15 seconds

5.5.4.2 IP Address Assignment by APIPA

- ❑ Item to acquire: IP Address
- ❑ Range of address: 169.254.1.0 to 169.254.254.255

Any IP address in the above range that is not used in the same network is assigned. However, communication over the router is not possible when the IP address is set by APIPA.

5.5.4.3 Manual Setting

The UB-E02 operates in accordance with the IP address stored in the internal parameter settings.

5.5.5 Internal Settings

5.5.5.1 Item List

Item	Parameter	Initial value	Exclusive utility		HTTP		Status printout
			Ref	Setting	Ref	Setting	Ref
IP address		192.168.192.168	o	o	o	o	o
Subnet mask		255.255.255.0	o	o	o	o	o
Gateway address		0.0.0.0	o	o	o	o	o
DHCP function	Disable/Enable	Disable	o	o	o	o	o
APIPA function	Disable/Enable	Disable	o	o	o	o	o
arp/ping IP setting	Disable/Enable	Enable	o	o	o	o	x
Community name 1 (read-only)	Max. 16 chars.	"public"	o	x	o	x	o
Community name 2 (read-write)	Max. 16 chars.	None	o	o	o	o	o
IP Trap 1	Disable/Enable	Disable	o	o	o	o	x
IP Trap 2	Disable/Enable	Disable	o	o	o	o	x
Community name (IP Trap #1)	Max. 16 chars.	None	o	o	o	o	x
Community name (IP Trap #2)	Max. 16 chars.	None	o	o	o	o	x
IP Trap #1 Address		None	o	o	o	o	x
IP Trap #2 Address		None	o	o	o	o	x
Password		None	x	o	x	o	x
Communication mode setting	Auto Negotiation /10BASE-T Half /10BASE-T Full /100BASE-TX Half /100BASE-TX Full	Auto negotiation	o	o	o	o	o
Hardware version			o	x	o	x	o
Firmware version			o	x	o	x	o
MAC address			o	x	o	x	o

o = possible x = impossible

5.5.5.2 Internal Parameter Setting Methods

1. Using the exclusive utility.
2. Using a browser
3. Using arp and ping commands (only to set IP address)

5.5.5.3 Setting with Exclusive utility

Settings cannot be made by the specified application software when the ENPC protocol is used. A dedicated utility which can set miscellaneous with the ENPC protocol is provided by EPSON.

5.5.5.4 Setting with Browser

Setting can be made by an HTTP browser when connected to the module. The new IP address takes effect when the printer power is turned off and back on.

5.5.5.5 Setting the IP Address with arp + ping

This function is available when it has been enabled.
The setting can be made from a host in the same segment as the module.
The host must support both arp and ping commands.
The new IP address takes effect when the module responds to the ping command.

Example-1: using SunOS

```
arp -s 123.456.789.123 00:00:48:06:00:01 temp  
ping 123.456.789.123
```

Example-2: using Windows

```
arp -s 123.456.789.123 00-00-48-06-00-01  
ping 123.456.789.123
```

5.5.5.6 How to check the Mac Address

The Mac address of the UB-E02 can be checked with any of the following methods:

- Printing the status sheet
- Checking the label on the UB-E02
- Checking the HTTP browser
- Checking the printer self-test (however, the self-test function is limited for each model.)

5.5.6 Initializing

To initialize the UB-E02 when the power is turned on or reset, the standby period is required for 10 seconds. During this period. All network functions do not work.

The waiting time is:

When the IP address setting is Manual (Fixed):	approximately 6 seconds
When the IP address setting is Auto:	approximately 13 seconds (It can be longer, depending on the reply time of the host.)

5.5.7 Version Upgrading

The module can upgrade its own firmware over the network.

5.5.7.1 Supported protocol

- TFTP

5.5.7.2 Upgrade Methods

- By TFTP command (for Windows XP/2000/NT4.0)
For more information, ask your dealer.

5.6 Environmental Specifications

Temperature: 0 to 50° C {32 to 122° F}

Humidity: 10 to 90% RH (non-condensing)

5.7 Storage Conditions

Temperature: -10 to 50° C {14 to 122° F}

☐ Humidity: 10 to 90% RH (non-condensing)

5.8 EMC and Safety Standards Applied

Europe: CE Marking
EN55022 Class B
EN50024
IEC61000-4-2
IEC61000-4-3
IEC61000-4-4
IEC61000-4-5
IEC61000-4-6
IEC61000-4-11

The printer in which the UB-E02 is installed does not conform to the following:
EN45501

North America: (EMI) FCC/ICES-003 Class A

Japan: (EMC) VCCI Class A

Oceania: (EMC) AS/NZS 3548, CISPR22 Class B

Appendix A

Definitions

A

ASB—Auto Status Back: The feature that allows the printer to send the status information back to the host computer automatically.

ARP—Address Resolution Protocol: Protocol which converts IP address to Ethernet address.

D

Domain—A group of computers administered together.

DHCP—Dynamic Host Configuration Protocol: Protocol which administers IP addresses, which operates on the UDP, in the whole network system together.

E

Ethernet—LAN, using CSMA/CD method.

I

ICMP—Internet Control Message Protocol: a protocol which notifies an error status to a sender when an error occurs.

M

MIB—Management Information Base: a set of variables (database) that a gateway running SNMP maintains.

N

netmask—A binary value used for a sub-network and IP inter-networks.

P

ping—Command to test an IP connection.

S

SNMP—Simple Network Management Protocol: a standard protocol used to monitor IP gateways, hosts, and the networks to which they are attached.

T

TCP—Transmission Control Protocol used for reliable end-to-end communication over an IP connection.

TCP/IP—Name given to the suite of protocols (including but not limited to TCP and IP) that govern the transmission and services of a network. The TCP indicates a transport layer and the IP indicates an internet layer.

TCP port—A logical connection point in the software on a TCP/IP host.

U

UDP—User Datagram Protocol: a connectionless type of a protocol which is suitable for transferring small packets.

EPSON

SEIKO EPSON CORPORATION

Printed in Japan