

DS-1630
User's Guide

Copyright

No part of this publication may be reproduced, stored in a retrieval system, or transmitted in any form or by any means, electronic, mechanical, photocopying, recording, or otherwise, without the prior written permission of Seiko Epson Corporation. No patent liability is assumed with respect to the use of the information contained herein. Neither is any liability assumed for damages resulting from the use of the information herein. The information contained herein is designed only for use with this Epson product. Epson is not responsible for any use of this information as applied to other products.

Neither Seiko Epson Corporation nor its affiliates shall be liable to the purchaser of this product or third parties for damages, losses, costs, or expenses incurred by the purchaser or third parties as a result of accident, misuse, or abuse of this product or unauthorized modifications, repairs, or alterations to this product, or (excluding the U.S.) failure to strictly comply with Seiko Epson Corporation's operating and maintenance instructions.

Seiko Epson Corporation and its affiliates shall not be liable for any damages or problems arising from the use of any options or any consumable products other than those designated as Original Epson Products or Epson Approved Products by Seiko Epson Corporation.

Seiko Epson Corporation shall not be held liable for any damage resulting from electromagnetic interference that occurs from the use of any interface cables other than those designated as Epson Approved Products by Seiko Epson Corporation.

© 2022 Seiko Epson Corporation. All rights reserved.

The contents of this manual and the specifications of this product are subject to change without notice.

Trademarks

- ❑ EPSON® is a registered trademark, and EPSON EXCEED YOUR VISION or EXCEED YOUR VISION is a trademark of the Seiko Epson Corporation.
- ❑ Microsoft®, Windows®, Windows Server®, and Windows Vista® are either registered trademarks or trademarks of Microsoft Corporation in the United States and/or other countries.
- ❑ Apple®, Mac OS®, and OS X® are trademarks of Apple Inc., registered in the U.S. and other countries.
- ❑ Adobe®, Adobe Reader®, and Acrobat® are registered trademarks of Adobe Systems Incorporated.
- ❑ Intel® is a registered trademark of Intel Corporation.
- ❑ The SuperSpeed USB Trident Logo is a registered trademark of USB Implementers Forum, Inc.
- ❑ Epson Scan 2 Software is based in part on the work of the Independent JPEG Group.
- ❑ libtiff

Copyright © 1988-1997 Sam Leffler

Copyright © 1991-1997 Silicon Graphics, Inc.

Permission to use, copy, modify, distribute, and sell this software and its documentation for any purpose is hereby granted without fee, provided that (i) the above copyright notices and this permission notice appear in all copies of the software and related documentation, and (ii) the names of Sam Leffler and Silicon Graphics may not be used in any advertising or publicity relating to the software without the specific, prior written permission of Sam Leffler and Silicon Graphics.

THE SOFTWARE IS PROVIDED "AS-IS" AND WITHOUT WARRANTY OF ANY KIND, EXPRESS, IMPLIED OR OTHERWISE, INCLUDING WITHOUT LIMITATION, ANY WARRANTY OF MERCHANTABILITY OR FITNESS FOR A PARTICULAR PURPOSE.

IN NO EVENT SHALL SAM LEFFLER OR SILICON GRAPHICS BE LIABLE FOR ANY SPECIAL, INCIDENTAL, INDIRECT OR CONSEQUENTIAL DAMAGES OF ANY KIND, OR ANY DAMAGES WHATSOEVER RESULTING FROM LOSS OF USE, DATA OR PROFITS, WHETHER OR NOT ADVISED OF THE POSSIBILITY OF DAMAGE, AND ON ANY THEORY OF LIABILITY, ARISING OUT OF OR IN CONNECTION WITH THE USE OR PERFORMANCE OF THIS SOFTWARE.

- ❑ General Notice: Other product names used herein are for identification purposes only and may be trademarks of their respective owners. Epson disclaims any and all rights in those marks.

Contents

Copyright

Trademarks

About This Manual

Introduction to the Manuals.	6
Marks and Symbols.	6
Descriptions Used in this Manual.	6
Operating System References.	7

Important Instructions

Safety Instructions.	8
Restrictions on Copying.	9

Scanner Basics

Part Names and Functions.	10
Buttons and Lights on the Control Panel.	11
Buttons.	11
Error Indicators.	12
Information on Applications.	12
Epson Scan 2.	12
Document Capture Pro / Document Capture.	13
EPSON Software Updater.	13
Options Information.	13
Network Interface Unit Codes.	13
Cleaning Kit Codes.	14

Specifications of Originals and Placing Originals

Specifications of Originals for Scanning from the ADF.	15
General Specifications for Originals being Scanned.	15
Types of Originals that Require Attention.	17
Types of Originals that Must Not be Scanned.	17
Placing Originals into the ADF.	18
Placing Standard Size Originals.	18
Placing Long Paper.	20
Placing Originals on the Scanner Glass.	21
Placing an Original.	21
Placing Thick Originals.	23

Basic Scanning

Scanning Using Epson Scan 2.	25
Setting a Resolution That Suits the Scanning Purpose.	28
Scanning Using Document Capture Pro (Windows).	28
Scanning Using Document Capture (Mac OS X).	32
Scanning Using a Scanner Button.	34

Advanced Scanning

Creating Scanned Images to Suit Your Needs.	35
Image Adjustment Features.	35
Editing Scanned Pages Using Epson Scan 2.	42
Saving as a Searchable PDF.	42
Saving as an Office Format File (for Windows Only).	43
Various Types of Saving and Transferring.	44
Sorting and Saving Scanned Images into a Separate Folder (for Windows Only).	44
Scanning to a Cloud Service.	45
Uploading to an FTP Server.	46
Attaching Scanned Images to an Email.	47
Printing Scanned Images.	48
Scanning Using Specified Scanning Settings (Job).	48
Setting a Job.	49
Assigning a Job to the Scanner Button.	49

Maintenance

Cleaning Outside the Scanner.	50
Cleaning the ADF.	50
Cleaning the Scanner Glass.	53
Energy Saving.	55
Transporting the Scanner.	55
Updating Applications and Firmware.	56

Solving Problems

Scanner Problems.	57
Scanner Lights Indicate an Error.	57
The Scanner Does Not Turn On.	57
Problems Starting Scanning.	57
Cannot Start Epson Scan 2.	57
Pressing a Scanner Button Does Not Start the Correct Application.	58
Paper Feeding Problems.	58

Contents

Removing Jammed Originals from the Scanner.	58	Help for Users in Singapore.	74
Multiple Originals Are Fed.	60	Help for Users in Thailand.	74
The Originals Get Dirty.	61	Help for Users in Vietnam.	74
Scanning Speed Slows Down when Scanning Continuously.	61	Help for Users in Indonesia.	75
Scanning Takes a Long Time.	61	Help for Users in Hong Kong.	76
Scanned Image Problems.	61	Help for Users in Malaysia.	77
Uneven Colors, Dirt, Spots, and so on Appear when Scanning from the Scanner Glass.	61	Help for Users in India.	77
Straight Lines Appear when Scanning from ADF.	62	Help for Users in the Philippines.	78
The Image Quality is Rough.	62		
Offset Appears in the Background of Images.	62		
Text is Blurred.	63		
Moiré Patterns (Web-Like Shadows) Appear.	63		
Cannot Scan the Correct Area on the Scanner Glass.	64		
The Edge of the Original is Not Scanned when Automatically Detecting the Size of the Original.	64		
Text is Not Recognized Correctly when Saving as a Searchable PDF.	64		
Binding Margins of a Booklet are Distorted or Blurred.	65		
Cannot Solve Problems in the Scanned Image.	65		
Uninstalling and Installing Applications.	65		
Uninstalling Your Applications.	65		
Installing Your Applications.	67		

Technical Specifications

General Scanner Specifications.	68
Dimensional Specifications.	69
Electrical Specifications.	69
Environmental Specifications.	69
System Requirements.	70

Standards and Approvals

Standards and Approvals for U.S. Model.	71
Standards and Approvals for European Model.	71
Standards and Approvals for Australian Model.	71

Where to Get Help

Technical Support Web Site.	72
Contacting Epson Support.	72
Before Contacting Epson.	72
Help for Users in Europe.	72
Help for Users in Taiwan.	73
Help for Users in Australia.	73

About This Manual

Introduction to the Manuals

The latest versions of the following manuals are available from the Epson support website.

<http://www.epson.eu/Support> (Europe)

<http://support.epson.net/> (outside Europe)

Setup Guide (paper manual)

Provides you with information on setting up the product and installing the application.

User's Guide (digital manual)

Provides instructions on using the product, maintenance, and solving problems.

As well as the manuals above, see the help included in the various Epson applications.

Marks and Symbols



Caution:

Instructions that must be followed carefully to avoid bodily injury.



Important:

Instructions that must be observed to avoid damage to your equipment.

Note:

Provides complementary and reference information.

Related Information

➔ Links to related sections.

Descriptions Used in this Manual

- Screenshots for the applications are from Windows 10 or Mac OS X v10.10.x. The content displayed on the screens varies depending on the model and situation.
- Illustrations used in this manual are for reference only. Although they may differ slightly from the actual product, the operating methods are the same.

Operating System References

Windows

In this manual, terms such as "Windows 10", "Windows 8.1", "Windows 8", "Windows 7", "Windows Vista", "Windows XP", "Windows Server 2012 R2", "Windows Server 2012", "Windows Server 2008 R2", "Windows Server 2008", "Windows Server 2003 R2", and "Windows Server 2003" refer to the following operating systems. Additionally, "Windows" is used to refer to all versions.

- Microsoft® Windows® 10 operating system
- Microsoft® Windows® 8.1 operating system
- Microsoft® Windows® 8 operating system
- Microsoft® Windows® 7 operating system
- Microsoft® Windows Vista® operating system
- Microsoft® Windows® XP operating system Service Pack 3
- Microsoft® Windows® XP Professional x64 Edition operating system Service Pack 2
- Microsoft® Windows Server® 2012 R2 operating system
- Microsoft® Windows Server® 2012 operating system
- Microsoft® Windows Server® 2008 R2 operating system
- Microsoft® Windows Server® 2008 operating system
- Microsoft® Windows Server® 2003 R2 operating system
- Microsoft® Windows Server® 2003 operating system Service Pack 2

Mac OS X

In this manual, "Mac OS X v10.11.x" refers to OS X El Capitan, "Mac OS X v10.10.x" refers to OS X Yosemite, "Mac OS X v10.9.x" refers to OS X Mavericks, and "Mac OS X v10.8.x" refers to OS X Mountain Lion. Additionally, "Mac OS X" is used to refer to "Mac OS X v10.11.x", "Mac OS X v10.10.x", "Mac OS X v10.9.x", "Mac OS X v10.8.x", "Mac OS X v10.7.x", and "Mac OS X v10.6.8".

Important Instructions

Safety Instructions

Read and follow these instructions to ensure safe use of this product. Make sure you keep this manual for future reference. Also, be sure to follow all warnings and instructions marked on the product.

- ❑ Some of the symbols used on your product are to ensure safety and proper use of the product. Visit the following Web site to learn the meaning of the symbols.
<http://support.epson.net/symbols>
- ❑ Place the product on a flat, stable surface that extends beyond the base of the product in all directions. If you place the product by the wall, leave more than 10 cm between the back of the product and the wall.
- ❑ Place the product close enough to the computer for the interface cable to reach it easily. Do not place or store the product outdoors, near excessive dirt or dust, water, heat sources, or in locations subject to shocks, vibrations, high temperature or humidity, direct sunlight, strong light sources, or rapid changes in temperature or humidity.
- ❑ Do not use with wet hands.
- ❑ Place the product near an electrical outlet where the power cord plug can be easily unplugged.
- ❑ The power cord should be placed to avoid abrasions, cuts, fraying, crimping, and kinking. Do not place objects on top of the cord and do not allow the power cord to be stepped on or run over. Be particularly careful to keep the cord straight at the end.
- ❑ Use only the power cord supplied with the product and do not use the cord with any other equipment. Use of other cords with this product or the use of the supplied power cord with other equipment may result in fire or electric shock.
- ❑ Use only the type of power source indicated on the product's label, and always supply power directly from a standard domestic electrical outlet.
- ❑ When connecting this product to a computer or other device with a cable, ensure the correct orientation of the connectors. Each connector has only one correct orientation. Inserting a connector in the wrong orientation may damage both devices connected by the cable.
- ❑ Avoid using outlets on the same circuit as photocopiers or air control systems that regularly switch on and off.
- ❑ If you use an extension cord with the product, make sure the total ampere rating of the devices plugged into the extension cord does not exceed the cord's ampere rating. Also, make sure the total ampere rating of all devices plugged into the wall outlet does not exceed the wall outlet's ampere rating.
- ❑ Never disassemble, modify, or attempt to repair the product, or product option by yourself except as specifically explained in the product's guides.
- ❑ Do not insert objects into any opening as they may touch dangerous voltage points or short out parts. Beware of electrical shock hazards.
- ❑ If damage occurs to the plug, replace the cord set or consult a qualified electrician. If there are fuses in the plug, make sure you replace them with fuses of the correct size and rating.
- ❑ Unplug the product and the power cord, and refer servicing to qualified service personnel under the following conditions: The power cord or plug is damaged; liquid has entered the product; the product or the power cord has been dropped or the case has been damaged; the product or the power cord does not operate normally or exhibits a distinct change in performance. (Do not adjust controls that are not covered by the operating instructions.)

Important Instructions

- Unplug the product and the power cord before cleaning. Clean with a damp cloth only. Do not use liquid or aerosol cleaners.
- If you are not going to use the product or options for a long period, be sure to unplug the power cord from the electrical outlet.
- After replacing consumable parts, dispose of them correctly following the rules of your local authority. Do not disassemble them.
- Do not place heavy objects on the scanner glass and do not press the glass with too much force.

Restrictions on Copying

Observe the following restrictions to ensure the responsible and legal use of your product.

Copying of the following items is prohibited by law:

- Bank bills, coins, government-issued marketable securities, government bond securities, and municipal securities
- Unused postage stamps, pre-stamped postcards, and other official postal items bearing valid postage
- Government-issued revenue stamps, and securities issued according to legal procedure

Exercise caution when copying the following items:

- Private marketable securities (stock certificates, negotiable notes, checks, etc.), monthly passes, concession tickets, etc.
- Passports, driver's licenses, warrants of fitness, road passes, food stamps, tickets, etc.

Note:

Copying these items may also be prohibited by law.

Responsible use of copyrighted materials:

Products can be misused by improperly copying copyrighted materials. Unless acting on the advice of a knowledgeable attorney, be responsible and respectful by obtaining the permission of the copyright holder before copying published material.

Scanner Basics

Part Names and Functions

Front

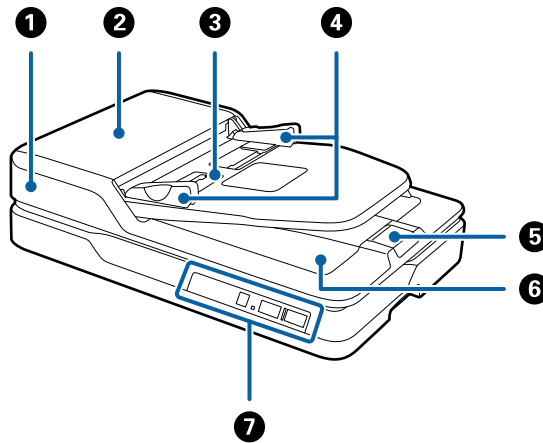

1	ADF (Automatic Document Feeder)	Feeds loaded originals automatically.
2	ADF cover	Open it when cleaning the ADF or removing jammed paper.
3	Input tray	Loads originals. When scanning is complete, check the center window for ejected originals.
4	Edge guides	Feeds originals straight into the scanner. Slide to the edges of the originals.
5	Stopper	Prevents ejected originals from falling off the tray extension.
6	Output tray	Holds originals ejected from the scanner.
7	Control panel	Operates the scanner.

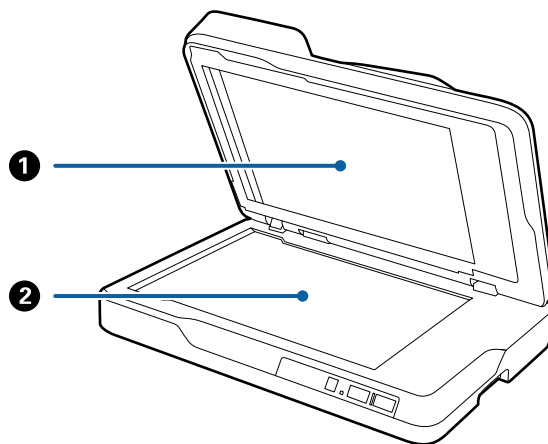

Scanner Basics

1	Document mat	Blocks external light while scanning. Remove it when cleaning the ADF or removing jammed originals.
2	Scanner glass	Place originals that you cannot feed using the ADF.

Back

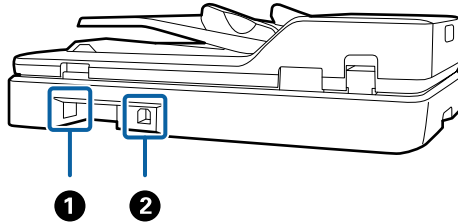

1	AC inlet	Connects the power cord.
2	USB port	Connects a USB cable.

Related Information

- ➔ [“Specifications of Originals for Scanning from the ADF” on page 15](#)
- ➔ [“Cleaning the ADF” on page 50](#)

Buttons and Lights on the Control Panel

Buttons

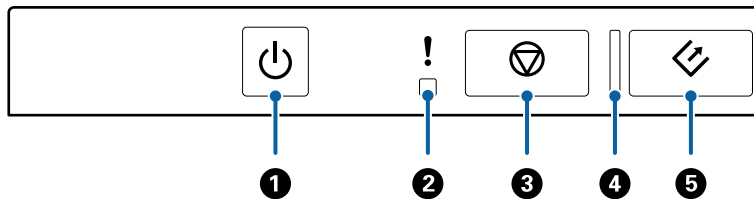

1	⏻	Power button	Turns the scanner on or off.
2	!	Error light	An error has occurred. See “Error Indicators of Light” for more details.
3	⏹	Stop button	Cancels scanning.
4	-	Ready light	On : The scanner is ready to be used. Flashing : The scanner is scanning, waiting to scan, processing, or sleeping. Off : The scanner cannot be used because the power is off or an error has occurred.

Scanner Basics

5		Start button	Starts scanning.
---	---	--------------	------------------

Related Information

➔ [“Error Indicators” on page 12](#)

Error Indicators

Error of scanner

Indicators	Situation	Solutions
!Flashing slowly	A paper jam occurred.	Open the ADF cover, and then remove jammed originals. Close the cover to release the error. Load the originals again.
!Flashing fast Ready light Flashing fast	A fatal error has occurred.	Turn the power off and on again. If the error continues to occur, contact your local dealer.
!On Ready light Off	The scanner has started in recovery mode because the firmware update failed.	Follow the steps below to try to update the firmware again. 1. Connect the computer and the scanner with a USB cable. (During recovery mode, you cannot update the firmware over a network connection.) 2. Visit your local Epson website for further instructions.

Related Information

➔ [“Removing Jammed Originals from the Scanner” on page 58](#)

Information on Applications

This section introduces the software products available for your scanner. The latest software can be installed at the Epson Web site.

Epson Scan 2

Epson Scan 2 is a driver for controlling your scanner, enabling a variety of scan settings. This also allows you to start either as a standalone application or by using TWAIN-compliant application software.

See the Epson Scan 2 help for details on using the application.

Document Capture Pro / Document Capture

This application allows you to rearrange pages or correct rotation for image data, and then save the data, send it by email, send it to a server, or send it to a cloud service. By registering frequently used scan process settings with a name such as "job", you can scan by simply selecting "job".

Document Capture Pro is for Windows only. For Mac OS X, use Document Capture, and for Windows Server, use Document Capture Pro Server.

See the Document Capture Pro help for details on using the application.

EPSON Software Updater

EPSON Software Updater is an application that checks for new or updated applications on the internet and installs them.

You can also update the scanner's digital manual.

Note:

Windows Server operating systems are not supported.

Options Information

Network Interface Unit Codes

You can scan through a network by using Document Capture Pro (Windows only). By registering frequently used scan process settings such as save, sort, transfer, and so on, with a name such as "job", you can reduce the workload and increase efficiency by simply selecting "job" on the control panel. See the manual for more details.

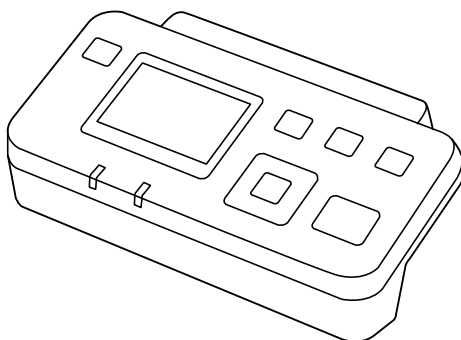

Part name	Codes ^{*2}	Specifications
Network Interface Unit ^{*1}	B12B808451 (European, Middle East, and African countries) B12B808461 (Asia Pacific countries excluding China and Korea) B12B808464 (China) B12B808466 (Korea)	Available for 1000BASE-T/100BASE-TX/10BASE-T, IPv6, IEEE802.3az

*1 When mounted, you cannot use the scanner or a computer over a USB connection.

Scanner Basics

*2 Codes may vary by region.

Cleaning Kit Codes

Use this when cleaning inside the ADF. This kit is composed of cleaning liquid and a cleaning cloth.

Part name	Codes
Cleaning Kit	B12B819291

Specifications of Originals and Placing Originals

Specifications of Originals for Scanning from the ADF

This section explains the specifications and conditions of originals that can be loaded in the ADF.

General Specifications for Originals being Scanned

Type of Original	Thickness	Size
Plain paper Fine paper Recycled paper	50 to 120 g/m ²	Single sided scanning <input type="checkbox"/> Maximum: 215.9×3,048.0 mm (8.5×120.0 in.) <input type="checkbox"/> Minimum: 89×127 mm (3.5×5.0 in.) Double sided scanning <input type="checkbox"/> Maximum: 215.9×297.0 mm (8.5×11.7 in.) <input type="checkbox"/> Minimum: 89×170 mm (3.5×6.7 in.)

Note:

All originals must be flat at the leading edge.

Specifications of Standard Size Originals for Single Sided Scanning

This section provides a list of the standard size originals you can load into the ADF.

Specifications of Originals and Placing Originals

Size	Measurement	Thickness	Paper Type	Loading Capacity
A4	210×297 mm (8.3×11.7 in.)	50 to 120 g/m ²	Plain paper Fine paper Recycled paper	Thickness of the stack of originals: under 5 mm (80 g/m ² : 50 sheets) The loading capacity varies depending on the paper type.
Letter	215.9×279.4 mm (8.5×11 in.)			
Legal	215.9×355.6 mm (8.5×14 in.)			
B5	182×257 mm (7.2×10.1 in.)			
A5	148×210 mm (5.8×8.3 in.)			
B6	128×182 mm (5.0×7.2 in.)			
A6	105×148 mm (4.1×5.8 in.)			

Related Information

➔ [“Placing Standard Size Originals” on page 18](#)

Specifications of Standard Size Originals for Double Sided Scanning

This section provides a list of the standard size originals you can load into the ADF.

Size	Measurement	Thickness	Paper Type	Loading Capacity
A4	210×297 mm (8.3×11.7 in.)	50 to 120 g/m ²	Plain paper Fine paper Recycled paper	Thickness of the stack of originals: under 5 mm (80 g/m ² : 50 sheets) The loading capacity varies depending on the paper type.
Letter	215.9×279.4 mm (8.5×11 in.)			
B5	182×257 mm (7.2×10.1 in.)			
A5	148×210 mm (5.8×8.3 in.)			

Specifications of Long Paper (for Single Sided Scanning Only)

This section provides the specifications for long paper that you can load into the ADF.

Specifications of Originals and Placing Originals

Size	Thickness	Paper Type	Loading Capacity
Width: 89.0 to 215.9 mm (3.5 to 8.5 in.) Length: 393.7 to 3,048.0 mm (15.5 to 120.0 in.)	50 to 120 g/m ²	Plain paper Fine paper Recycled paper	1 sheet

Note:

You can scan long paper up to 393.7 mm (15.5 inches) in length at a resolution of 600 dpi or less, and over 393.7 mm (15.5 inches) and up to 3,048.0 mm (120 inches) at a the resolution of 300 dpi or less.

Related Information

➔ [“Placing Long Paper” on page 20](#)

Types of Originals that Require Attention

The following types of originals may not be successfully scanned using the ADF.

- Originals with an uneven surface such as letter head paper
- Originals with fold lines
- Perforated originals

Types of Originals that Must Not be Scanned

To prevent damage to the originals or the scanner, do not load the following originals in the ADF. For these types of originals, use the scanner glass.

Note:

The following list is just an example.

- Photos
- Originals with holes
- Booklets
- Non-paper originals (such as clear files, fabric, and metal foil)
- Originals with staples or paper clips
- Originals with glue attached
- Wrinkled or curled originals
- Transparent originals such as OHP film
- Originals with carbon paper on the back
- Originals with wet ink
- Originals with sticky notes attached
- Originals with labels or tapes not firmly stuck down
- Post cards
- Envelopes

Specifications of Originals and Placing Originals

- Business cards
- Plastic cards
- Carbon-less papers
- Thermal papers
- Coated paper

Placing Originals into the ADF

Placing Standard Size Originals

Note:

Remove any documents from the scanner glass. Make sure there is no dust or dirt on the glass and the clear part shown below before scanning.

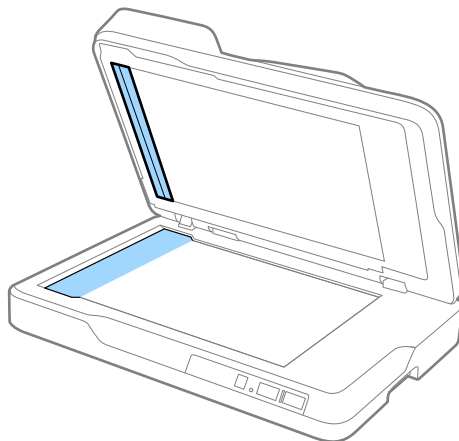

1. Slide the edge guides on the ADF input tray all the way out. When scanning A4 size paper, raise the stopper.

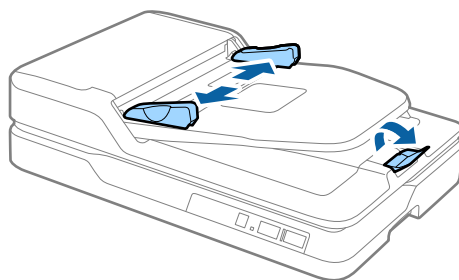

Specifications of Originals and Placing Originals

2. Fan the originals.

Hold both ends of the originals and fan them a few times, and then tap the top edges of the paper on a flat surface to align the sheets.

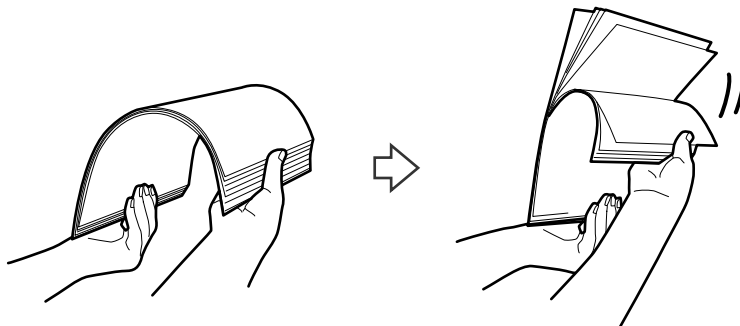

3. Place the originals into the ADF input tray facing up and with the top edge facing into the ADF.
Slide the originals into the ADF until they meet resistance.

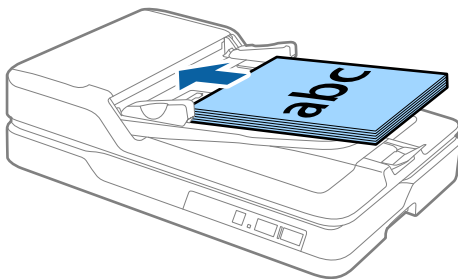

4. Slide the edge guides to fit the edge of the originals making sure there are no gaps between the originals and the edge guides. Otherwise, the originals may be fed askew.

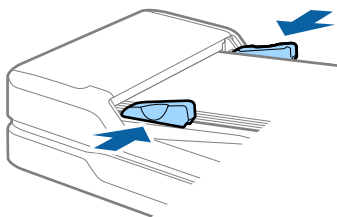

Related Information

- ➔ [“Specifications of Standard Size Originals for Single Sided Scanning” on page 15](#)
- ➔ [“Cleaning the ADF” on page 50](#)
- ➔ [“Cleaning the Scanner Glass” on page 53](#)

Specifications of Originals and Placing Originals

Placing Long Paper

Note:

Remove any documents from the scanner glass. Make sure there is no dust or dirt on the glass and the clear part shown below before scanning.



1. Slide the edge guides on the ADF input tray all the way out.

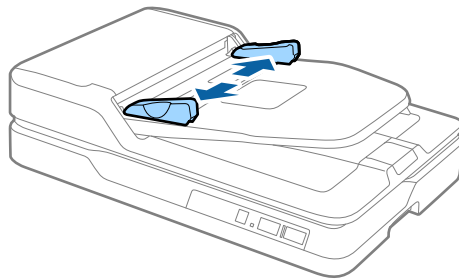

2. Load the original into the input tray straight, facing up and with the top edge facing into the ADF. Slide the original into the ADF until it meets resistance.

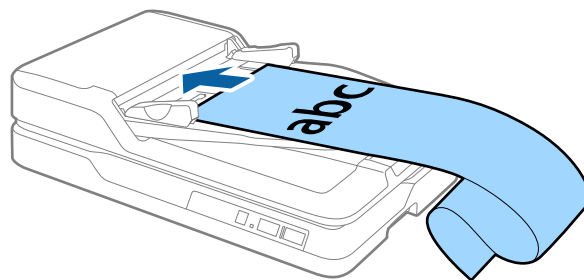

3. Adjust the edge guides to fit the edge of the long paper making sure there is no gap between the paper edge and the edge guide. Otherwise, the originals may be fed askew or jammed.

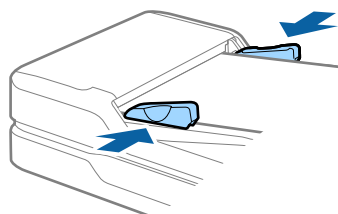

Specifications of Originals and Placing Originals

Note:

Support the long paper on the input side so that it does not drop out of the ADF, and the output side so that the ejected paper does not fall from the output tray.

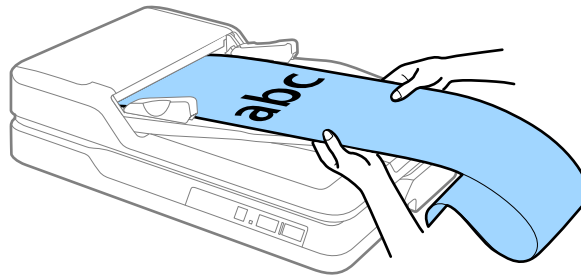

Related Information

- ➔ “Specifications of Long Paper (for Single Sided Scanning Only)” on page 16
- ➔ “Cleaning the ADF” on page 50
- ➔ “Cleaning the Scanner Glass” on page 53

Placing Originals on the Scanner Glass

Placing an Original



Important:

- Do not place heavy objects on the scanner glass and do not press the glass with too much force.
- Do not open the ADF wider than an angle of 70 degrees. This could damage the hinge.

1. Open the ADF.

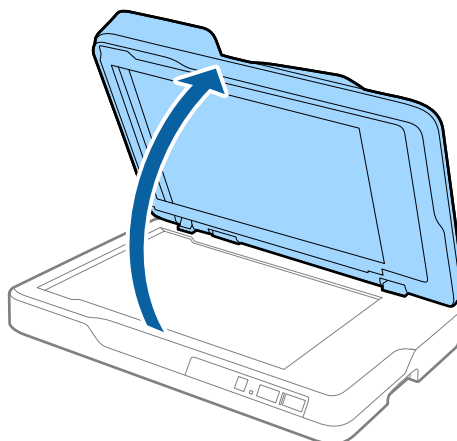

Specifications of Originals and Placing Originals

- Place your original face down on the scanner glass making sure the upper corner of the side you want to scan is against the corner of the scanner next to the arrow mark.

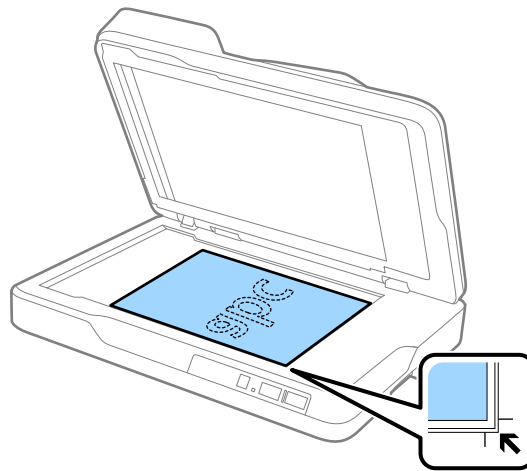

Note:

- ❑ The maximum size of the original you can scan is 216×297 mm (8.5×11.7 in.).
- ❑ You can avoid cropping by moving the original about 2.5 mm (0.1 inches) away from the top and side edges indicated by ① and ② in the following figure.

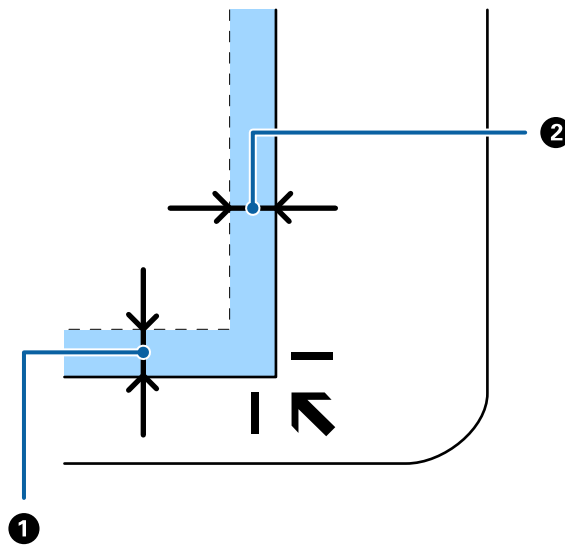

Specifications of Originals and Placing Originals

3. Close the ADF gently so that your original does not move.

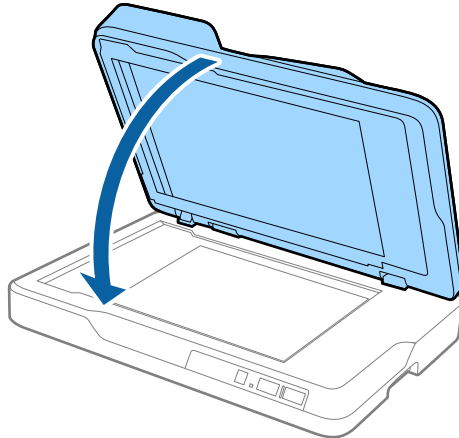

Note:

- ❑ Always keep the scanner glass clean.
- ❑ Do not leave originals on the scanner glass for an extended period of time as they may stick.

Placing Thick Originals

! **Important:**

- ❑ Do not place heavy objects on the scanner glass and do not press the glass with too much force.
- ❑ Do not open the ADF wider than an angle of 70 degrees. This could damage the hinge.

1. Open the ADF.

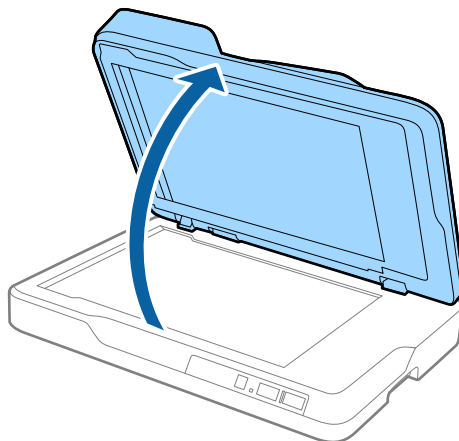

Specifications of Originals and Placing Originals

2. Place your thick original face down on the scanner glass making sure the upper corner of the side you want to scan is against the corner of the scanner next to the arrow mark.

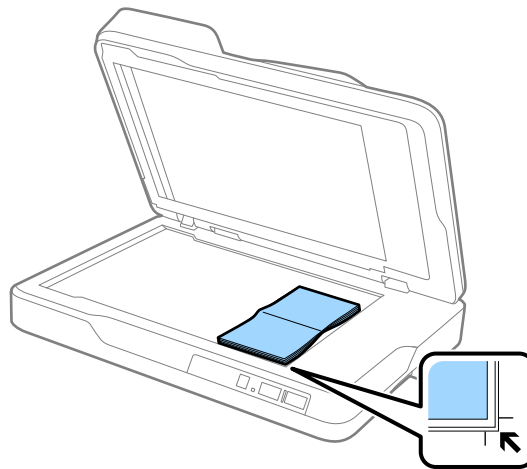

3. Close the ADF gently so that your original does not move.

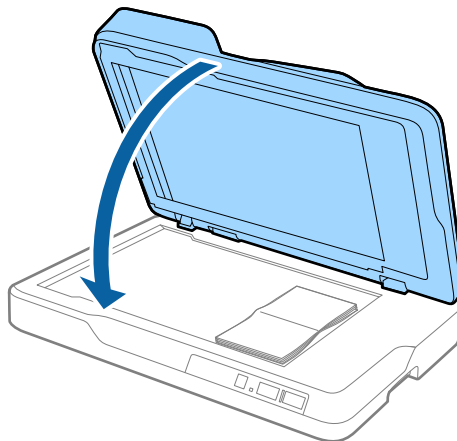

Note:

If you scan originals over 10 mm (0.4 inch) thick, scan the original by leaving the ADF open and gently pressing down on your original to flatten it.

Basic Scanning

Scanning Using Epson Scan 2

You can scan the originals using detailed settings that are suitable for text documents.

1. Place the original.

Note:

If you want to scan multiple originals, place them into the ADF.

2. Start Epson Scan 2.

- Windows 10

Click the start button, and then select **All apps > EPSON > Epson Scan 2**.

- Windows 8.1/Windows 8/Windows Server 2012 R2/Windows Server 2012

Enter the application name in the search charm, and then select the displayed icon.

- Windows 7/Windows Vista/Windows XP/Windows Server 2008 R2/Windows Server 2008/Windows Server 2003 R2/Windows Server 2003

Click the start button, and select **All Programs** or **Programs > EPSON > Epson Scan 2 > Epson Scan 2**.

- Mac OS X

Select **Go > Applications > Epson Software > Epson Scan 2**.

Basic Scanning

3. Make the following settings on the **Main Settings** tab.

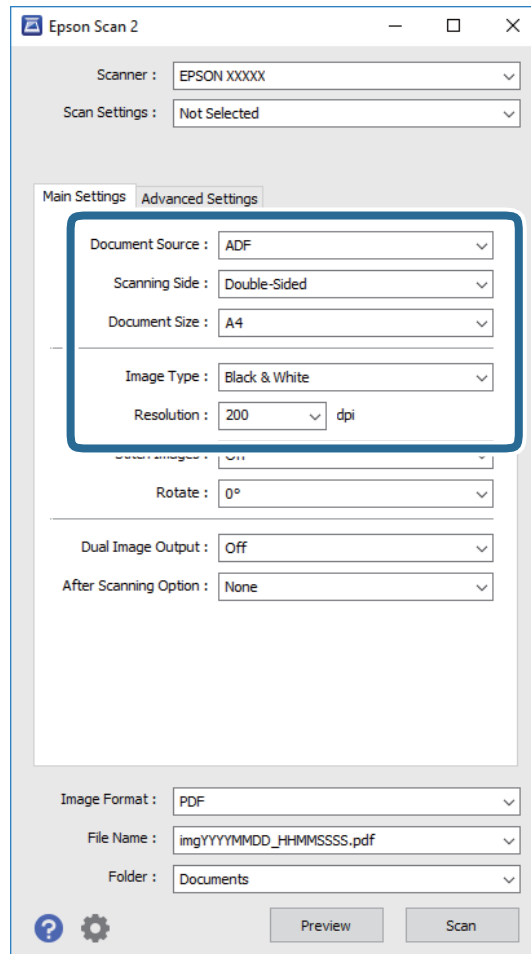

- Document Source:** Select the source where the original is placed.
 - Scanning Side:** Select the side of the original you want to scan when scanning from ADF.
 - Document Size:** Select the size of the original you placed.
 - Image Type:** Select the color for saving the scanned image.
 - Resolution:** Select the resolution.
4. Make other scan settings if necessary.
- You can preview the scanned image by click the **Preview** button. The preview window opens, and the previewed image is displayed.
When you performed preview from the ADF, original is ejected from the ADF after a preview is generated. Place the ejected original again.

Basic Scanning

- ❑ On the **Advanced Settings** tab, you can make image adjustments using detailed settings which are suitable for text documents, such as the following.
 - ❑ **Unsharp Mask:** Select to enhance and sharpen the outlines of the image.
 - ❑ **Descreening:** Select to remove moiré patterns (web-like shadows) that appear when scanning printed papers such as a magazine.
 - ❑ **Text Enhancement:** Select to make blurred letters in the original clear and sharp.
 - ❑ **Auto Area Segmentation:** Select to make letters clear and images smooth when performing black and white scanning for a document that contains images.

Note:

Some items may not be available depending on other settings you made.

5. Set the file saving settings.

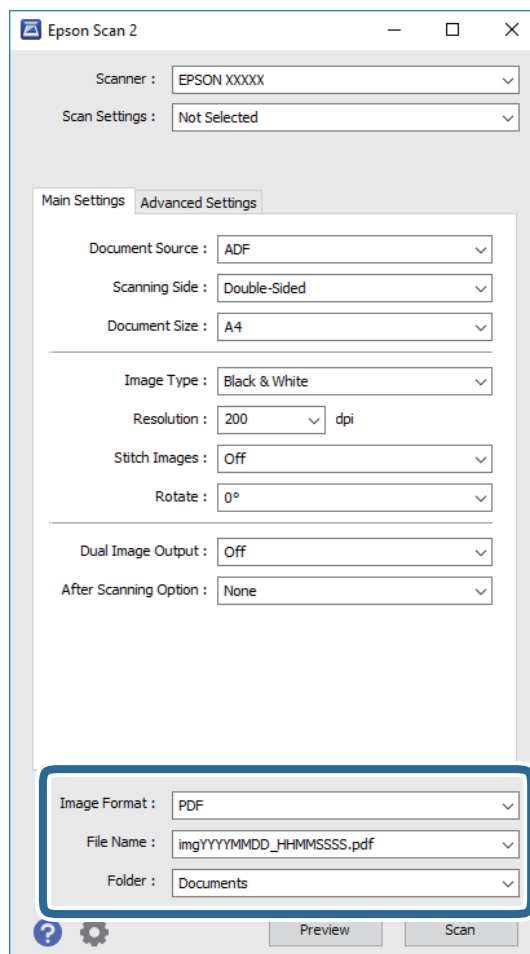

- ❑ **Image Format:** Select the save format from the list.
You can make detailed settings for each save format except BITMAP and PNG. After selecting the save format, select **Options** from the list.
- ❑ **File Name:** Check the save file name displayed.
You can change settings for file name by selecting **Settings** from the list.
- ❑ **Folder:** Select the save folder for the scanned image from the list.
You can select other folder or create a new folder by selecting **Select** from the list.

Basic Scanning

6. Click **Scan**.

The scanned image is saved to the folder you specified.

Related Information

- ➔ [“Placing Originals into the ADF” on page 18](#)
- ➔ [“Placing Originals on the Scanner Glass” on page 21](#)
- ➔ [“Epson Scan 2” on page 12](#)
- ➔ [“Setting a Resolution That Suits the Scanning Purpose” on page 28](#)
- ➔ [“Image Adjustment Features” on page 35](#)
- ➔ [“Editing Scanned Pages Using Epson Scan 2” on page 42](#)

Setting a Resolution That Suits the Scanning Purpose

Advantages and Disadvantages of Increasing the Resolution

Resolution indicates the number of pixels (smallest area of an image) for each inch (25.4 mm), and is measured in dpi (dots per inch). The advantage of increasing the resolution is that the details in the image become fine. The disadvantage is that the file size becomes large.

- File size becomes large
(When you double the resolution, the file size becomes about four times larger.)
- Scanning, saving, and reading the image takes a long time
- Sending and receiving emails or faxes takes a long time
- The image becomes too large to fit the display or print on the paper

List of Recommended Resolutions to Suit Your Purpose

See the table and set the appropriate resolution for the purpose of your scanned image.

Purpose	Resolution (Reference)
Displaying on the screen Sending by email	Up to 200 dpi
Using Optical Character Recognition (OCR) Creating a text searchable PDF	200 to 300 dpi
Printing using a printer Sending by fax	200 to 300 dpi

Scanning Using Document Capture Pro (Windows)

This application allows you to perform various tasks such as saving the image to your computer, sending it by email, printing, and uploading to a server or a cloud service. You can also use a variety of methods to sort the

Basic Scanning

documents into separate files, such as detecting barcodes or characters on the pages. You can also register scanning settings for a job to simplify scanning operations. See the help for details on Document Capture Pro.

1. Place the original.

2. Start Document Capture Pro.

Windows 10

Click the start button, and then select **All apps > Epson Software > Document Capture Pro**.

Windows 8.1/Windows 8

Enter the application name in the search charm, and then select the displayed icon.

Windows 7/Windows Vista/Windows XP

Click the start button, and then select **All Programs** or **Programs > Epson Software > Document Capture Pro**.

Note:

You may need to select the scanner you want to use from the scanners list.

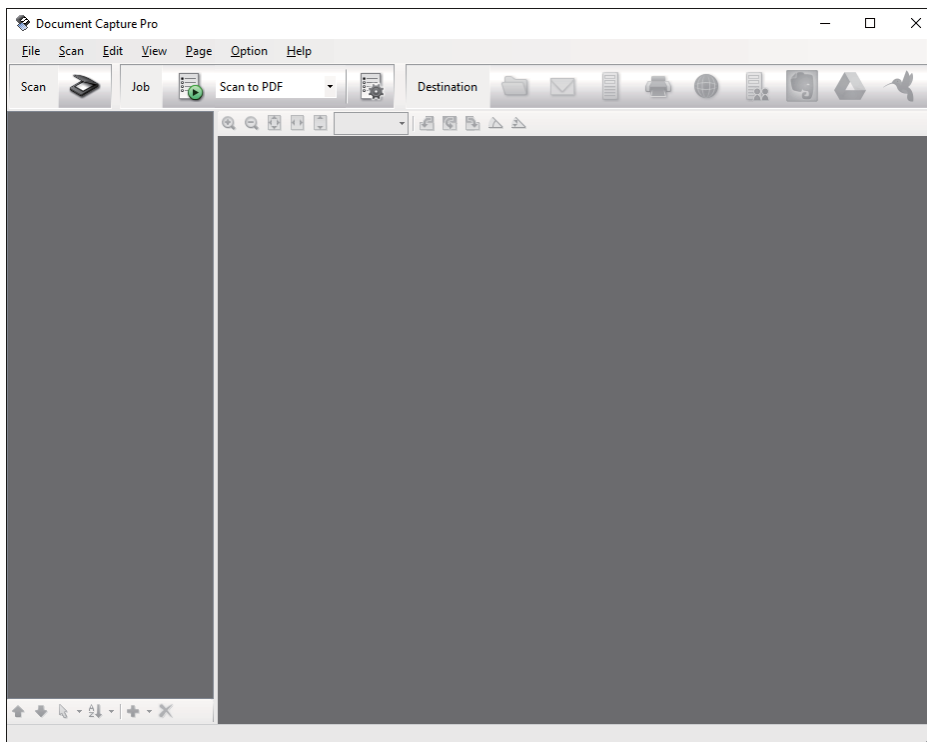

Basic Scanning

3. Click .

The **Scan** window is displayed.

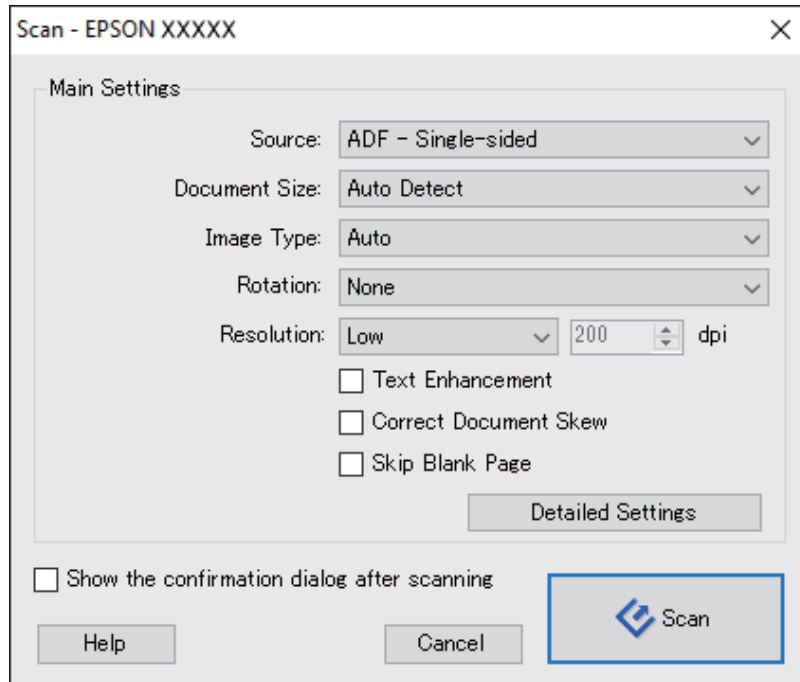

4. Make the following settings.

- Source:** Select the source where the original is placed.
- Document Size:** Select the size of the original you placed.
- Image Type:** Select the color you want to use to save the scanned image.
- Rotation:** Select the rotation angle depending on the original you want to scan.
- Resolution:** Select the resolution.

Note:

You can also adjust the image using following items.

- Text Enhancement:** Select to make blurred letters in the original clear and sharp.
- Correct Document Skew:** Select to correct the slant of the original.
- Skip Blank Page:** Select to skip blank pages if there are any in the originals.
- Detailed Settings** button: Select to use Epson Scan 2 features to adjust scanned images.

5. Click **Scan**.

The scanned document is displayed in Document Capture Pro.

6. Check the scanned images, and edit them if necessary.

Basic Scanning

7. When you have finished checking the image, click one of the destination icons.

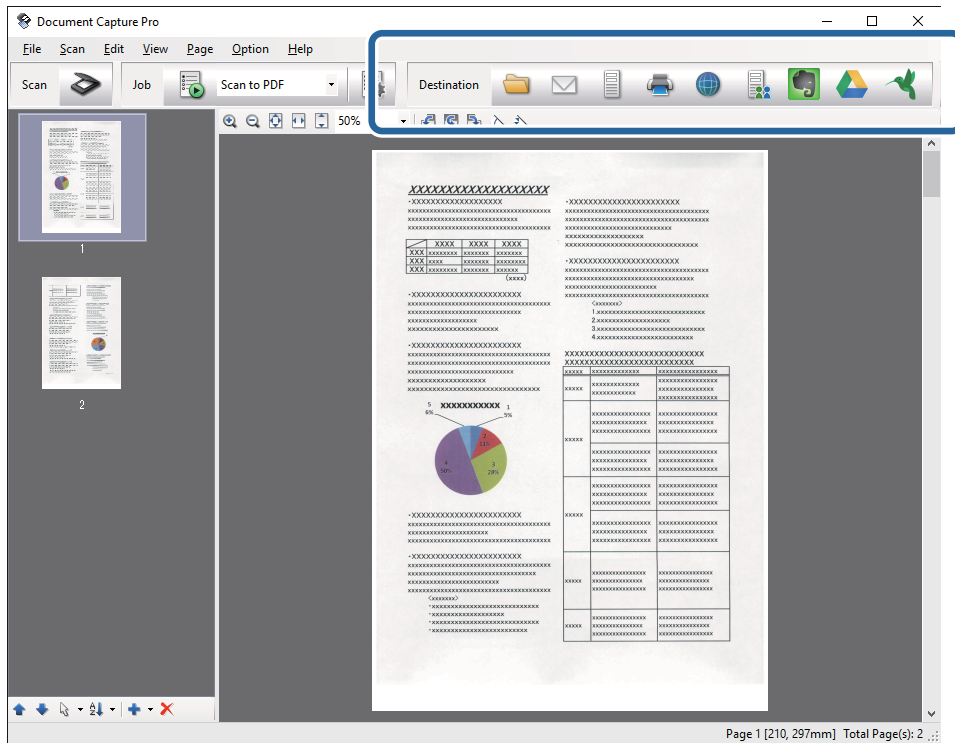

One of the following windows is displayed depending on the icon you selected; **Batch Save**, **Transfer Settings**, or another window.

Note:

- If you want to upload to a cloud service, you need to set up your account with the cloud service in advance.
- If you want to use Evernote as the destination, download the Evernote application from the Evernote Corporation Website and install it before using this feature.
- On the **Batch Save** window or the **Transfer Settings** window, click **File Name & Separation Settings**, and then select **Apply job separation** to sort the documents into separate files by using a variety of detection methods such as barcodes or text in the scanned images.

8. Make settings for each item in the window, and then click **Send** or **OK**.

9. Follow the on-screen instructions.

The scanned image is saved to a folder, attached to an email, uploaded to a cloud service, and so on depending on the function you selected.

Related Information

- ➔ [“Placing Originals into the ADF” on page 18](#)
- ➔ [“Placing Originals on the Scanner Glass” on page 21](#)
- ➔ [“Document Capture Pro / Document Capture” on page 13](#)
- ➔ [“Setting a Resolution That Suits the Scanning Purpose” on page 28](#)

Scanning Using Document Capture (Mac OS X)

This application allows you to perform various tasks such as saving the image to your computer, sending it by email, printing, and uploading to a server or a cloud service. You can register scanning settings for a job to simplify scanning operations. See the help for details on Document Capture.

Note:

Do not use the Fast User Switching function while using your scanner.

1. Place the original.
2. Start Document Capture.

Select **Finder > Go > Applications > Epson Software > Document Capture**.

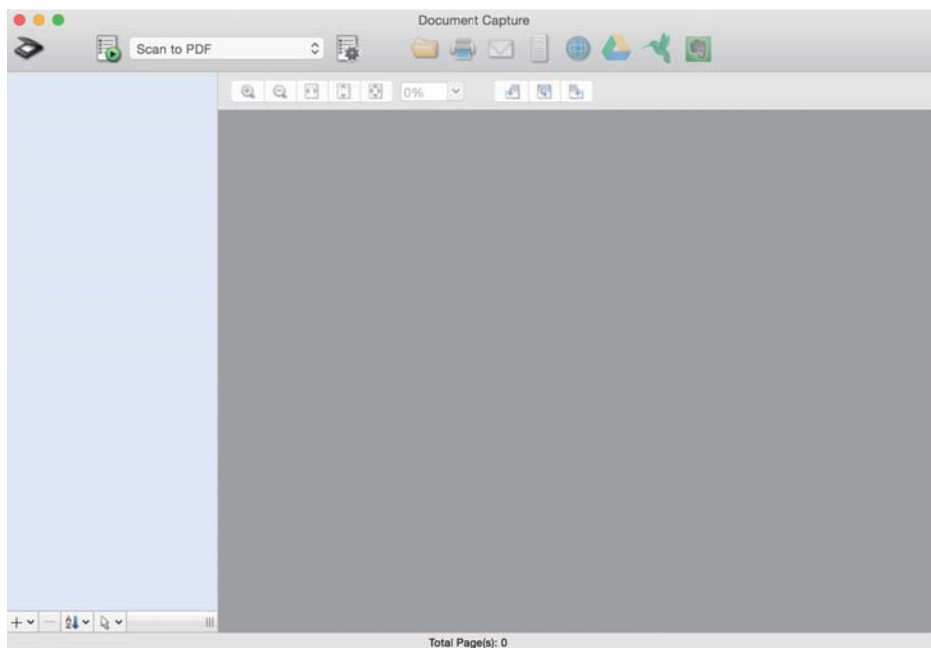

Note:

You may need to select the scanner you want to use from the scanners list.

Basic Scanning

3. Click .

The **Scan Settings** window is displayed.

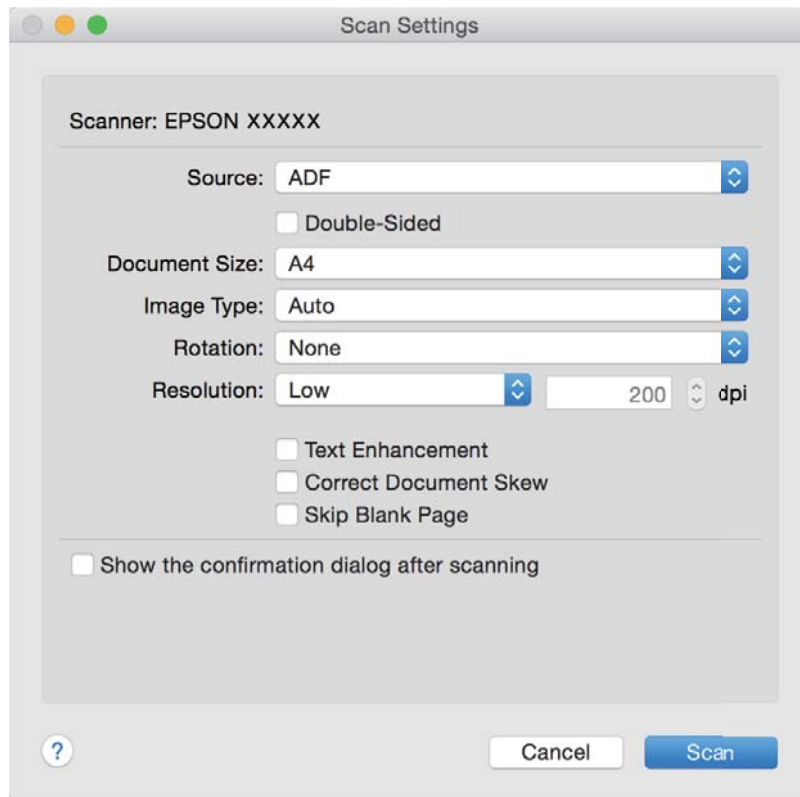

4. Make the following settings.

- Source:** Select the source where the original is placed.
- Document Size:** Select the size of the original you placed.
- Image Type:** Select the color you want to use to save the scanned image.
- Rotation:** Select the rotation angle depending on the original you want to scan.
- Resolution:** Select the resolution.

Note:

You can also adjust the image using following items.

- Text Enhancement:** *Select to make blurred letters in the original clear and sharp.*
- Correct Document Skew:** *Select to correct the slant of the original.*
- Skip Blank Page:** *Select to skip blank pages if there are any in the originals.*

5. Click **Scan**.

The scanned document is displayed in Document Capture.

6. Check the scanned images, and edit them if necessary.
7. When you have finished checking the image, click one of the destination icons.
One of the transfer settings windows is displayed depending on the icon you selected.

Basic Scanning

Note:

- ❑ *If you want to upload to a cloud service, you need to set up your account with the cloud service in advance.*
- ❑ *If you want to use Evernote as the destination, download the Evernote application from the Evernote Corporation Website and install it before using this feature.*

8. Make settings for each item in the window, and then click **Send** or **OK**.

9. Follow the on-screen instructions.

The scanned image is saved to a folder, attached to an email, uploaded to a cloud service, and so on depending on the function you selected.

Related Information

- ➔ [“Placing Originals into the ADF” on page 18](#)
- ➔ [“Placing Originals on the Scanner Glass” on page 21](#)
- ➔ [“Document Capture Pro / Document Capture” on page 13](#)
- ➔ [“Setting a Resolution That Suits the Scanning Purpose” on page 28](#)

Scanning Using a Scanner Button

You can scan using the button on your scanner.

Note:

- ❑ *Make sure that Epson Scan 2 is installed on your computer and the scanner is connected to your computer correctly.*
- ❑ *When Document Capture Pro (Windows) or Document Capture (Mac OS X) is installed on your computer, you can assign the job to a button on the scanner and run the job by pressing it.*

1. Place the original.

2. Press the  button.

Note:

*When using Document Capture Pro (Windows) or Document Capture (Mac OS X), the product starts the job that was assigned in the **Job Settings** window.*

Related Information

- ➔ [“Placing Originals into the ADF” on page 18](#)
- ➔ [“Placing Originals on the Scanner Glass” on page 21](#)
- ➔ [“Buttons” on page 11](#)
- ➔ [“Document Capture Pro / Document Capture” on page 13](#)
- ➔ [“Scanning Using Specified Scanning Settings \(Job\)” on page 48](#)

Advanced Scanning

Creating Scanned Images to Suit Your Needs

Image Adjustment Features

You can adjust scanned images using the features on the **Advanced Settings** tab in Epson Scan 2.

Except for a few features, you can check the adjustment results in the preview window.

Note:

Some items may not be available depending on other settings you made.

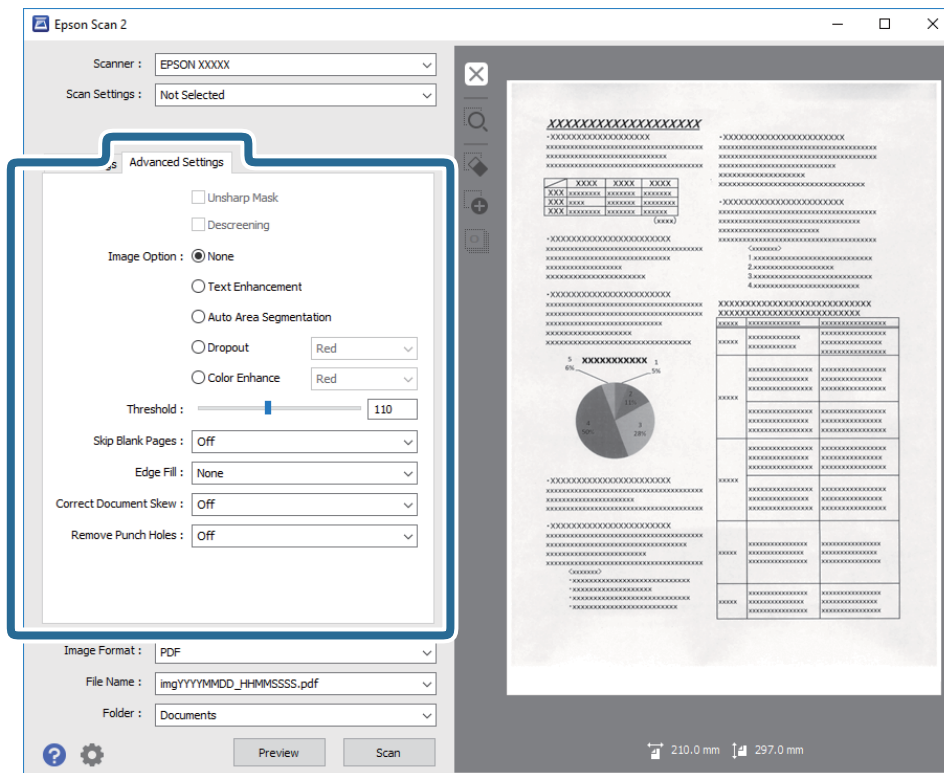

Related Information

- ➔ [“Unsharp Mask” on page 36](#)
You can enhance and sharpen the outlines of the image.
- ➔ [“Descreening” on page 37](#)
You can remove moiré patterns (web-like shadows) that appear when scanning printed paper such as a magazine.
- ➔ [“Text Enhancement” on page 37](#)
You can make blurred letters in the original clear and sharp. You can also reduce the offset or unevenness of the background.
- ➔ [“Auto Area Segmentation” on page 38](#)
You can make letters clear and images smooth when performing black and white scanning for a document that contains images.

Advanced Scanning

- ➔ **“Dropout” on page 38**
You can remove the color specified from the scanned image, and then save it in grayscale or black and white. For example, you can erase marks or notes you wrote in the margins with color pen when scanning.
- ➔ **“Color Enhance” on page 38**
You can enhance the color specified for the scanned image, and then save it in grayscale or black and white. For example, you can enhance letters or lines that are in light colors.
- ➔ **“Brightness” on page 39**
You can adjust the brightness for the whole image.
- ➔ **“Contrast” on page 39**
You can adjust the contrast for the whole image. If you increase the contrast, the bright areas become brighter, and the dark areas become darker. On the other hand, if you lower the contrast, the differences between the bright and dark areas of the image are less defined.
- ➔ **“Gamma” on page 39**
You can adjust the gamma (brightness of the intermediate range) for the whole image. If the image is too light or too dark, you can adjust the brightness.
- ➔ **“Threshold” on page 40**
You can adjust the border for monochrome binary (black and white). Increase the threshold, the black color area becomes larger. Decrease the threshold, the white color area becomes larger.
- ➔ **“Skip Blank Pages” on page 40**
You can skip blank pages if there are any in the originals.
- ➔ **“Edge Fill” on page 40**
You can remove the shadow created around the scanned image.
- ➔ **“Correct Document Skew” on page 41**
You can correct the slant of the original.
- ➔ **“Remove Punch Holes” on page 41**
You can remove the shadows of holes on the scanned image when scanning originals with punched holes.

Unsharp Mask

You can enhance and sharpen the outlines of the image.



Note:

*This feature is not available when selecting the **Main Settings** tab > **Image Type** > **Black & White**.*

Advanced Scanning

Descreening

You can remove moiré patterns (web-like shadows) that appear when scanning printed paper such as a magazine.



To check for moiré patterns, display the image at 100 % (1:1). If the displayed image is zoomed out, the image appears rough and may look like it has moiré patterns.

Note:

- To use this feature, set the **Resolution** on the **Main Settings** tab to 600 dpi or less.
- This feature is not available when selecting the **Main Settings** tab > **Image Type** > **Black & White**.
- The effect of this feature cannot be checked in the preview window.
- This feature softens the sharpness of the scanned image.

Image Option

You can select the effect for the scanned image.

Text Enhancement

You can make blurred letters in the original clear and sharp. You can also reduce the offset or unevenness of the background.



You can select the level of the effect when selecting the **Main Settings** tab > **Image Type** > **Color** or **Grayscale**.

Note:

To use this feature, set the **Resolution** on the **Main Settings** tab to 600 dpi or less.

Advanced Scanning

Auto Area Segmentation

You can make letters clear and images smooth when performing black and white scanning for a document that contains images.



You can adjust the quality of the image part of the original from **Brightness** and **Contrast**.

Note:

- You can only make settings for this feature when selecting the **Main Settings** tab > **Image Type** > **Black & White**.
- To use this feature, set the **Resolution** on the **Main Settings** tab to 600 dpi or less.

Dropout

You can remove the color specified from the scanned image, and then save it in grayscale or black and white. For example, you can erase marks or notes you wrote in the margins with color pen when scanning.



If you select **Customize** from the color list in **Dropout**, you can make settings for the color you want to remove while checking the preview window (for Windows only).

Note:

This feature is not available when selecting the **Main Settings** tab > **Image Type** > **Auto** or **Color**.

Color Enhance

You can enhance the color specified for the scanned image, and then save it in grayscale or black and white. For example, you can enhance letters or lines that are in light colors.



If you select **Customize** from the color list in **Color Enhance**, you can make settings for the color you want to enhance while checking the preview window (for Windows only).

Note:

This feature is not available when selecting the **Main Settings** tab > **Image Type** > **Auto** or **Color**.

Advanced Scanning

Brightness

You can adjust the brightness for the whole image.



Note:

*This feature is not available depending on the settings on the **Main Settings** tab > **Image Type** or the settings on the **Advanced Settings** tab.*

Contrast

You can adjust the contrast for the whole image. If you increase the contrast, the bright areas become brighter, and the dark areas become darker. On the other hand, if you lower the contrast, the differences between the bright and dark areas of the image are less defined.



Note:

*This feature is not available depending on the settings on the **Main Settings** tab > **Image Type** or the settings on the **Advanced Settings** tab.*

Gamma

You can adjust the gamma (brightness of the intermediate range) for the whole image. If the image is too light or too dark, you can adjust the brightness.



Note:

*This feature is not available depending on the settings on the **Main Settings** tab > **Image Type** or the settings on the **Advanced Settings** tab.*

Advanced Scanning

Threshold

You can adjust the border for monochrome binary (black and white). Increase the threshold, the black color area becomes larger. Decrease the threshold, the white color area becomes larger.

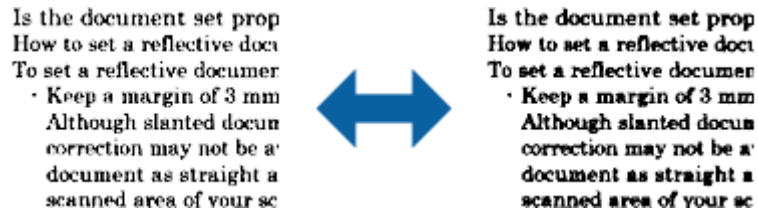

Note:

This feature may not be available depending on the settings on the **Main Settings** tab > **Image Type** or the settings on the **Advanced Settings** tab.

Skip Blank Pages

You can skip blank pages if there are any in the originals.

You can select the amount of blank page detection. If you set this to a high level, you can skip any originals with light colors or offset as blank pages.

If the result is not what you expected, select **Skip Blank Pages** > **Settings**, and then adjust **User Defined Level**. Select again **Skip Blank Pages** > **User Defined Level**.

Note:

- Some pages may be incorrectly skipped as blank pages.
- This feature is not available when scanning double-sided originals that are stitched.

Edge Fill

You can remove the shadow created around the scanned image.



For double-sided scanning, the settings for the edge fill range are mirror-reversed for the back of the original.

If you select **Settings**, the **Edge Fill Level** screen is displayed, and you can adjust the edge fill ranges for the top, bottom, left, and right.

Note:

The effect of this feature cannot be checked in the preview window.

Advanced Scanning

Correct Document Skew

You can correct the slant of the original.



Off

The slant of the original is not corrected.

Paper Skew

Corrects the slant of originals that are fed askew.

Contents Skew

Corrects the slant of the content of the original that was printed at an angle and so on.

Paper and Contents Skew

Corrects the slant of the original that is fed askew as well as the content of the original.

Note:

- When using this feature, areas that are fed askew are corrected using white.
- To use this feature, set the **Resolution** on the **Main Settings** tab to 600 dpi or less.
- This feature may not be able to correct documents that have been over skewed.
- The effect of this feature cannot be checked in the preview window.

Remove Punch Holes

You can remove the shadows of holes on the scanned image when scanning originals with punched holes.

You can remove the shadows of round or square punch holes that are within a range of 20 mm (0.79 in.) from the edges of the original.



Note:

- This feature is only available when you are scanning white or light colored originals.
- Depending on the scanned originals, the shadows of the punch holes may not be removed.
- The effect of this feature cannot be checked in the preview window.

Editing Scanned Pages Using Epson Scan 2

You can edit pages of scanned images using the features on the **Main Settings** tab in Epson Scan 2.

Stitch Images

You can stitch the images on the front and rear when scanning both sides of the original. Select the layout for stitching the images.

Note:

*This feature is available when you have selected **Double-Sided** in **Scanning Side**.*

Rotate

You can rotate the original clockwise and scan it. Select the rotation angle depending on the original you want to scan.

Note:

*If you select **Auto** and scan the original, the image is rotated by detecting the orientation of the text information. However, this may take some time depending on the image size, and so on.*

***Auto** is only available if the EPSON Scan OCR component (Windows) or EPSON Scan 2 OCR component (Mac OS X) is installed.*

Saving as a Searchable PDF

You can save the scanned image as a Searchable PDF. This is a PDF in which searchable text data is embedded.

Note:

- Text on the originals is recognized using Optical Character Recognition (OCR), and then embedded in the scanned image.*
- This feature is only available when the EPSON Scan OCR component (Windows) or Epson Scan 2 OCR component (Mac OS X) is installed.*

1. Place the original.
2. Start Epson Scan 2.
3. Make settings for each item on the **Main Settings** tab.
4. Click **Preview**.
5. Place the ejected original again when using the ADF.
6. Check the preview, and make other settings on the **Advanced Settings** tab if necessary.
7. Select **Searchable PDF** from the **Image Format** list.
8. Select **Options** from the **Image Format** list to open the **Image Format Options** window.
9. Select the **Text** tab on the **Image Format Options** window.
10. Check that the language of the original is selected in the **Text Language** list.

Advanced Scanning

11. Click **OK** to close the **Image Format Options** window.
12. Check the save file name displayed in **File Name**.
13. Select the save folder for the scanned image from the **Folder** list.
14. Click **Scan**.

The scanned image is saved as a Searchable PDF.

Related Information

- ➔ [“Scanning Using Epson Scan 2” on page 25](#)
- ➔ [“Placing Originals into the ADF” on page 18](#)
- ➔ [“Placing Originals on the Scanner Glass” on page 21](#)
- ➔ [“Text is Not Recognized Correctly when Saving as a Searchable PDF” on page 64](#)

Saving as an Office Format File (for Windows Only)

You can save the scanned image as a Microsoft® Office format file using Document Capture Pro.

You can select the following formats.

- Microsoft® Word (.docx)
- Microsoft® Excel® (.xlsx)
- Microsoft® PowerPoint® (.pptx)

Note:

This feature is only available when the EPSON Scan OCR component is installed.

1. Place the original.
2. Start Document Capture Pro.
3. Click  .
The **Scan** window is displayed.
4. Make the scanning settings, and then click **Scan**.
5. Check the scanned images, and edit them if necessary.

Advanced Scanning

- When you have finished checking the image, click one of the destination icons.

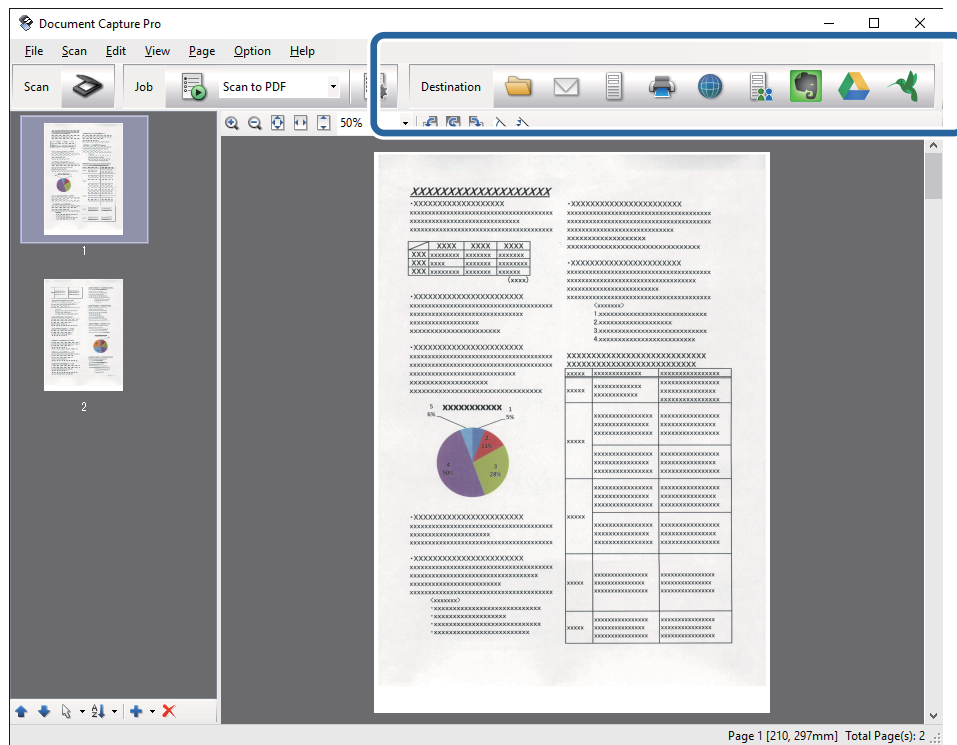

The **Batch Save**, **Transfer Settings**, or another window opens.

- Select the Office format file you want to save as from the **File Type** list.
- Click **Options** to display the **Detailed Settings** window.
- Make settings for each item, and then click **OK** to close the **Detailed Settings** window.
- Make other settings if necessary, and then click **Send** or **OK**.

The scanned image is saved as an Office format file.

Related Information

- ➔ [“Scanning Using Document Capture Pro \(Windows\)” on page 28](#)
- ➔ [“Placing Originals into the ADF” on page 18](#)
- ➔ [“Placing Originals on the Scanner Glass” on page 21](#)

Various Types of Saving and Transferring

Sorting and Saving Scanned Images into a Separate Folder (for Windows Only)

You can sort scanned images automatically and save them to a separate folder using Document Capture Pro.

Advanced Scanning

To sort scanned images, you can use a variety of detection methods such as blank pages inserted between the originals or barcodes on the originals.

1. Place the originals including indicators, such as blank pages, between the pages where you want to separate the scanned images.
2. Start Document Capture Pro.
3. Click  .
The **Scan** window is displayed.
4. Make the scanning settings, and then click **Scan**.
5. Check the scanned images, and edit them if necessary.
6. When you have finished checking the image, select the destination.
The **Batch Save** window or the **Transfer Settings** window is displayed.
7. Click **File Name & Separation Settings**.
8. Select **Apply job separation**, and then click **Separation Settings**.
9. Select the separation method and the method for specifying the folder name on the **Job Separation Settings** window, and then click **OK**.
10. Make other settings on the **File Name & Separation Settings** window, and then click **OK**.
11. Make other settings on the **Batch Save** window or the **Transfer Settings** window, and then click **OK** or **Send**.
Scanned images are saved separately based on the separation method selected.

Related Information

- ➔ [“Scanning Using Document Capture Pro \(Windows\)” on page 28](#)
- ➔ [“Placing Originals into the ADF” on page 18](#)
- ➔ [“Placing Originals on the Scanner Glass” on page 21](#)

Scanning to a Cloud Service

You can upload scanned images to cloud services using Document Capture Pro (Windows) or Document Capture (Mac OS X).

Note:

- Create a cloud service account before using this function.
- If you want to use Evernote as the destination, download the Evernote application from the Evernote Corporation Website, and then install it before using this feature.

1. Place the original.
2. Start Document Capture Pro (Windows) or Document Capture (Mac OS X).

Advanced Scanning

3. Click .

The **Scan** window is displayed.
4. Make the scanning settings, and then click **Scan**.
5. Check the scanned images, and edit them if necessary.
6. When you have finished checking the image, click the destination icon.

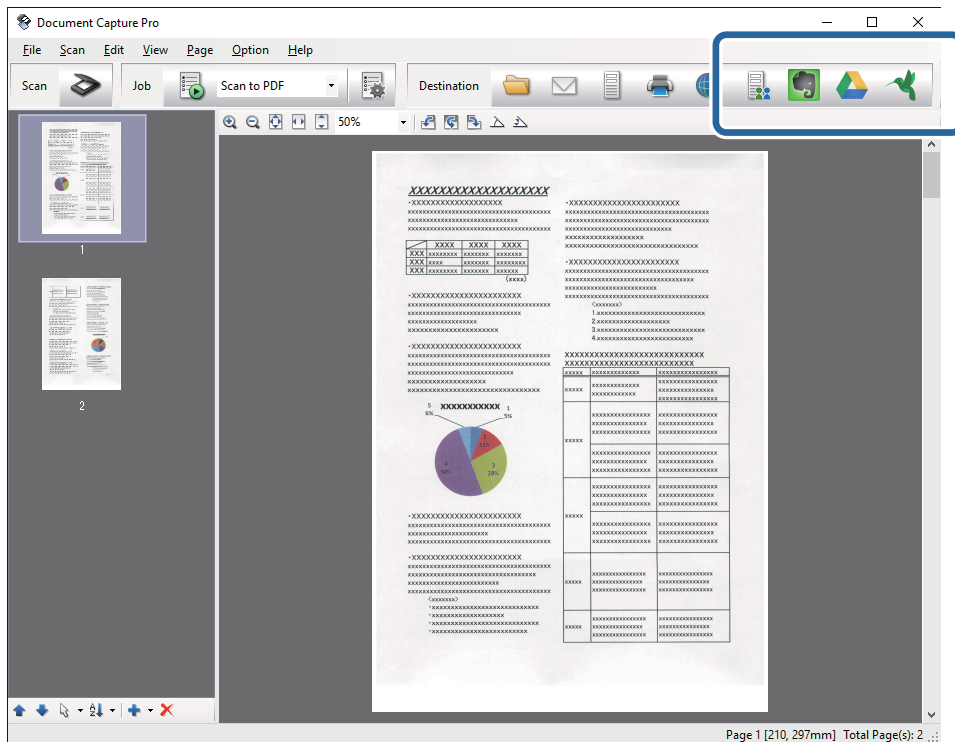

The **Transfer Settings** window is displayed.

7. Make settings for each item, and then click **Send**.

The scanned Image is sent to the selected cloud service.

Related Information



- ➔ [“Scanning Using Document Capture Pro \(Windows\)” on page 28](#)
- ➔ [“Scanning Using Document Capture \(Mac OS X\)” on page 32](#)
- ➔ [“Placing Originals into the ADF” on page 18](#)
- ➔ [“Placing Originals on the Scanner Glass” on page 21](#)

Uploading to an FTP Server

You can upload scanned images to an FTP server using Document Capture Pro (Windows) or Document Capture (Mac OS X).

1. Place the original.

Advanced Scanning

2. Start Document Capture Pro (Windows) or Document Capture (Mac OS X).
3. Click .
The **Scan** window is displayed.
4. Make the scanning settings, and then click **Scan**.
5. Check the scanned images, and edit them if necessary.
6. When you have finished checking the image, click the  icon.
The **Transfer Settings** window is displayed.
7. Make settings for each item, and then click **Send**.

Note:

Contact your network administrator for the settings of your FTP server.



The scanned image is sent to your FTP server.

Related Information

- ➔ [“Scanning Using Document Capture Pro \(Windows\)” on page 28](#)
- ➔ [“Scanning Using Document Capture \(Mac OS X\)” on page 32](#)
- ➔ [“Placing Originals into the ADF” on page 18](#)
- ➔ [“Placing Originals on the Scanner Glass” on page 21](#)

Attaching Scanned Images to an Email

You can attach scanned images directly to an email using Document Capture Pro (Windows) or Document Capture (Mac OS X).

1. Place the original.
2. Start Document Capture Pro (Windows) or Document Capture (Mac OS X).
3. Click .
The **Scan** window is displayed.
4. Make the scanning settings, and then click **Scan**.
5. Check the scanned images, and edit them if necessary.
6. When you have finished checking the image, click the  icon.
The **Batch Save** window is displayed.
7. Make settings for each item, and then click **OK**.

The email client on your computer starts automatically, and the scanned image is attached to an email.

Related Information

- ➔ [“Scanning Using Document Capture Pro \(Windows\)” on page 28](#)
- ➔ [“Scanning Using Document Capture \(Mac OS X\)” on page 32](#)
- ➔ [“Placing Originals into the ADF” on page 18](#)
- ➔ [“Placing Originals on the Scanner Glass” on page 21](#)



Printing Scanned Images

You can print scanned images directly from an Epson printer connected to the computer.

Note:

Before using this feature, check the following.

- The Epson printer is connected to the same computer to which the scanner is connected.*
- The printer driver is correctly installed on the computer.*

1. Place the original.
2. Start Document Capture Pro (Windows) or Document Capture (Mac OS X).
3. Click  .
The **Scan** window is displayed.
4. Make the scanning settings, and then click **Scan**.
5. Check the scanned images, and edit them if necessary.
6. When you have finished checking the image, click the  icon.
The **Print Settings** window opens.
7. Make settings for each item, and then click **OK**.
The scanned image is printed from the printer.

Related Information

- ➔ [“Scanning Using Document Capture Pro \(Windows\)” on page 28](#)
- ➔ [“Scanning Using Document Capture \(Mac OS X\)” on page 32](#)
- ➔ [“Placing Originals into the ADF” on page 18](#)
- ➔ [“Placing Originals on the Scanner Glass” on page 21](#)

Scanning Using Specified Scanning Settings (Job)

You can create a "Job" which is a set of specified scanning settings such as the sorting method, saving format, destination, and so on.

You can set the job in Document Capture Pro (Windows) or Document Capture (Mac OS X).

You can also assign the job to a button on the scanner, and run the job by pressing it.



Advanced Scanning

Setting a Job

1. Start Document Capture Pro (Windows) or Document Capture (Mac OS X).
2. Click the  (**Manage Job**) icon on the main window.
The **Job Management** window is displayed.
3. On the **Job Management** window, click **Add** (Windows) or the + icon (Mac OS X).
The **Job Settings** window opens.
4. Make the job settings on the **Job Settings** window.
 - Job Name:** Enter a name for the job.
 - Scan** tab: Set scanning settings on the tab.
 - Output** tab: Set the output format of the scanned image on the tab.
 - Destination:** Select the destination of the scanned image.
5. Click **OK** to close the **Job Settings** window.
6. Click **OK** on the **Job Management** window.
The job is set in the Document Capture Pro or Document Capture.

Assigning a Job to the Scanner Button

You can assign a job to the scanner's button, and run the job by pressing the button.

1. Start Document Capture Pro (Windows) or Document Capture (Mac OS X).
2. Click the  (**Manage Job**) icon on the main window.
The **Job Management** window is displayed.
3. Click **Event Settings** on the **Job Management** window (Windows), or click the  icon at the bottom of the screen (Mac OS X).
4. Click the job name to select the job you want to assign from the pull-down menu.
5. Click **OK** on the **Job Management** window.
The job is assigned to the scanner button.

Related Information

- ➔ [“Buttons” on page 11](#)
- ➔ [“Scanning Using a Scanner Button” on page 34](#)
- ➔ [“Placing Originals into the ADF” on page 18](#)
- ➔ [“Placing Originals on the Scanner Glass” on page 21](#)

Maintenance

Cleaning Outside the Scanner

Wipe off any stains on the outer case with a dry cloth or a cloth dampened with mild detergent and water.

! *Important:*

- Never use alcohol, thinner, or any corrosive solvent to clean the scanner. Deformation or discoloration may occur.*
- Do not let water get inside the product. This could cause a malfunction to occur.*
- Never open the scanner case.*

1. Press the  button to turn off the scanner.
2. Unplug the power cord from the scanner.
3. Clean the outer case with a cloth dampened with mild detergent and water.

Cleaning the ADF

After using the scanner for a while, paper and room dust in the paper path may cause paper feed or scanned image quality problems. In such cases, or when a message asking you to perform cleaning is displayed on your computer, clean the ADF.

! *Important:*

- Never use alcohol, thinner, or any corrosive solvent to clean the scanner. Deformation or discoloration may occur.*
- Never spray any liquid or lubricant on the scanner. Damage to equipment or circuits may cause abnormal operations.*
- Never open the scanner case.*

1. Open the ADF cover.

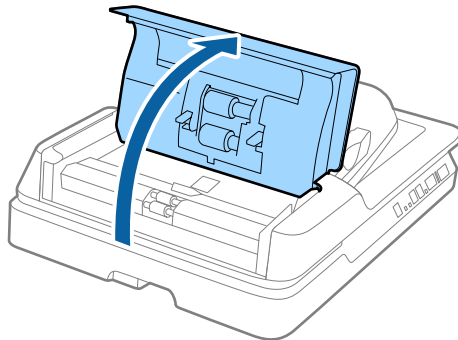

Maintenance

2. Wipe off any dust or dirt on the roller using a genuine Epson cleaning kit or a soft, damp cloth.

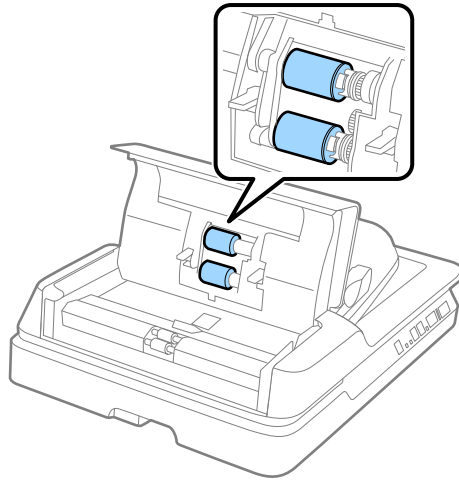

3. Close the ADF cover.

4. Open the ADF.

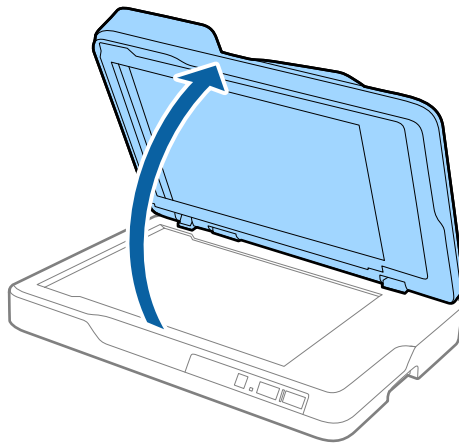

Maintenance

5. Remove the document mat.

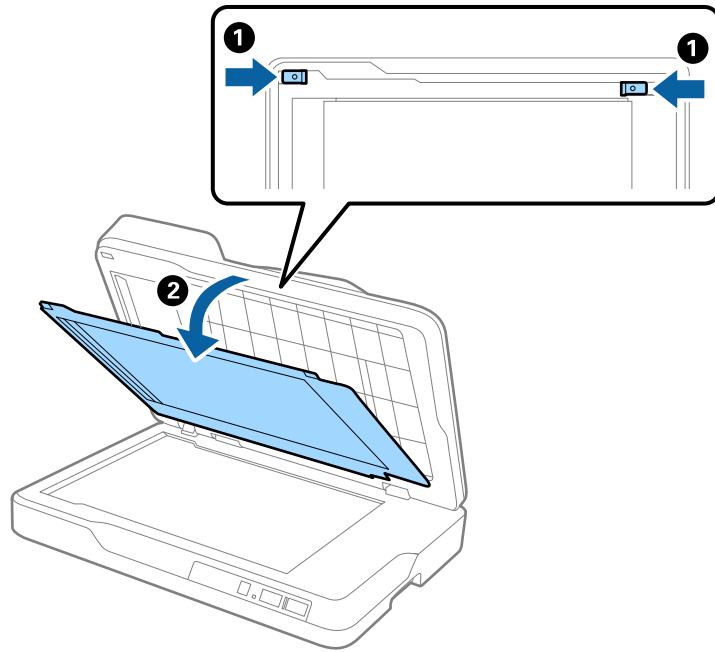

6. Use a soft, dry, clean cloth or a genuine Epson cleaning kit to clean the clear parts on the reverse side of the document mat.

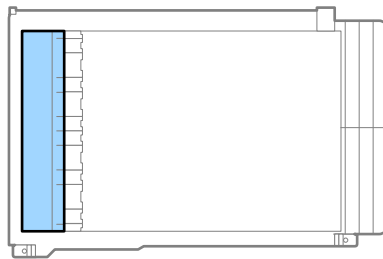

Maintenance

! **Important:**

Do not wipe the clear part with too much force. Otherwise, the clear part may be damaged. If the clear part bends in the wrong direction, it can cause paper feed problems.

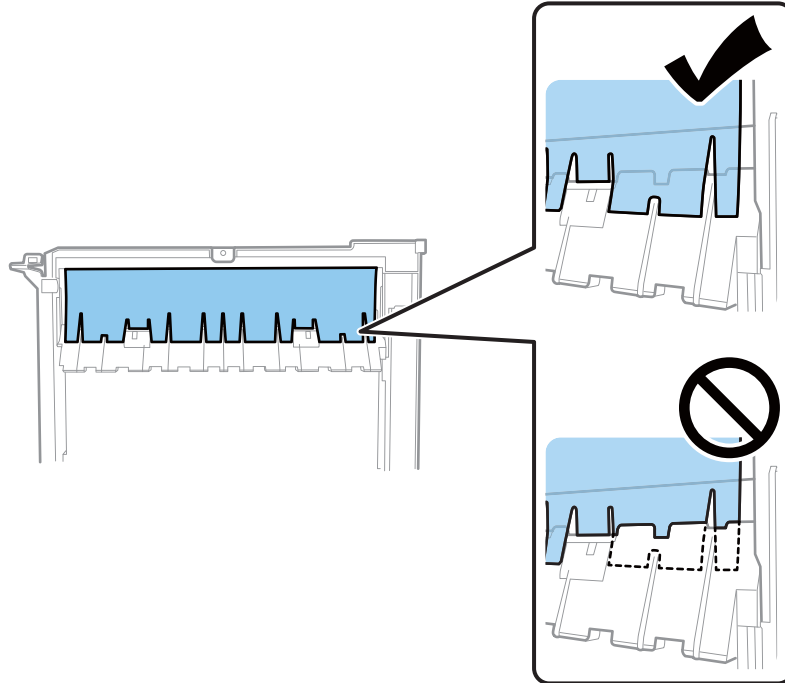

- Attach the document mat.

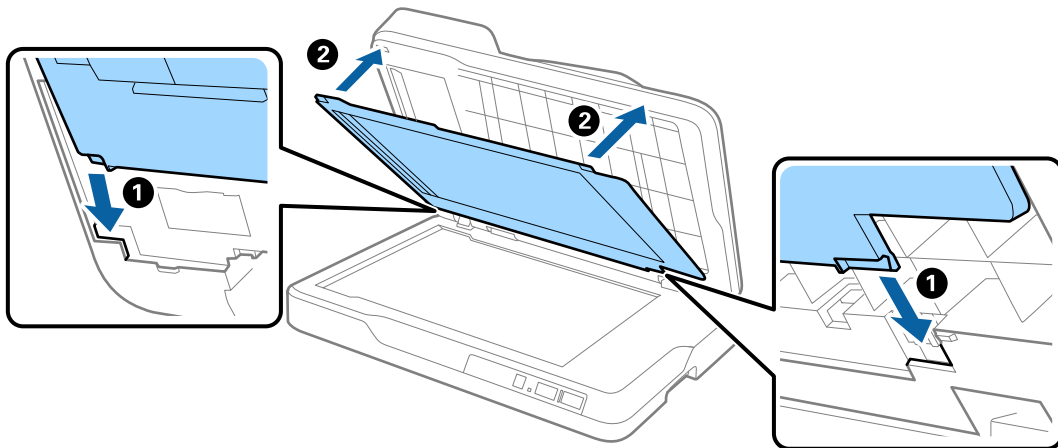

- Close the ADF.

Related Information

➔ [“Cleaning Kit Codes” on page 14](#)

Cleaning the Scanner Glass

When the scanned images are smeared or scuffed, clean the scanner glass.

Maintenance

! **Important:**

- ❑ *Never use alcohol, thinner, or any corrosive solvent to clean the scanner. Deformation or discoloration may occur.*
- ❑ *Never spray any liquid or lubricant on the scanner. Damage to equipment or circuits may cause abnormal operations.*
- ❑ *Never open the scanner case.*

1. Open the ADF.

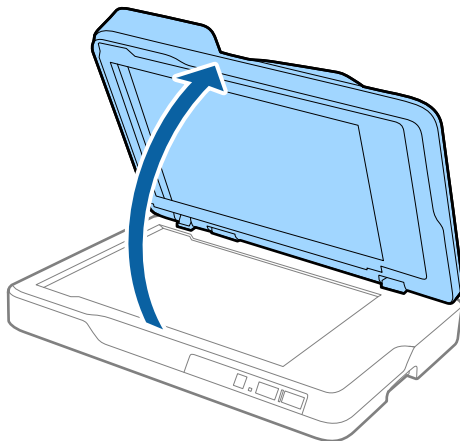

2. Use a soft, dry, clean cloth to clean the surface of the scanner glass.

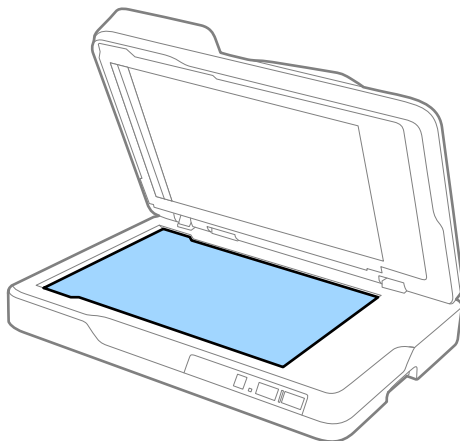

! **Important:**

- ❑ *Do not place too much force on the glass surface.*
- ❑ *Do not use a brush or a hard stuff. Any scratches on the glass may affect the scan quality.*
- ❑ *If the glass surface is stained with grease or some other hard-to-remove material, use a small amount of glass cleaner on a soft cloth to remove it. Wipe off all remaining liquid.*
- ❑ *Do not use the Epson cleaning kit for the glass surface.*

3. Close the ADF.

Energy Saving

You can save energy by using the sleep mode or auto power off mode when no operations are performed by the scanner. You can set the time period before the scanner enters sleep mode and turns off automatically. Any increase will affect the product's energy efficiency. Consider the environment before making any changes.

1. Start Epson Scan 2 Utility.

Windows 10

Click the start button, and then select **All apps > EPSON > Epson Scan 2 > Epson Scan 2 Utility**.

Windows 8.1/Windows 8/Windows Server 2012 R2/Windows Server 2012

Start screen > Apps > Epson > Epson Scan 2 Utility.

Windows 7/Windows Vista/Windows XP/Windows Server 2008 R2/Windows Server 2008/Windows Server 2003 R2/Windows Server 2003

Click the start button, and then select **All Programs (or Programs) > EPSON > Epson Scan 2 > Epson Scan 2 Utility**.

Mac OS X

Select **Go > Applications > EPSON Software > Epson Scan 2 Utility**.

2. Click the **Power Save** tab.

3. Set the **Sleep Timer (minutes)** or **Power Off Timer (minutes)**, and then click **Set**.

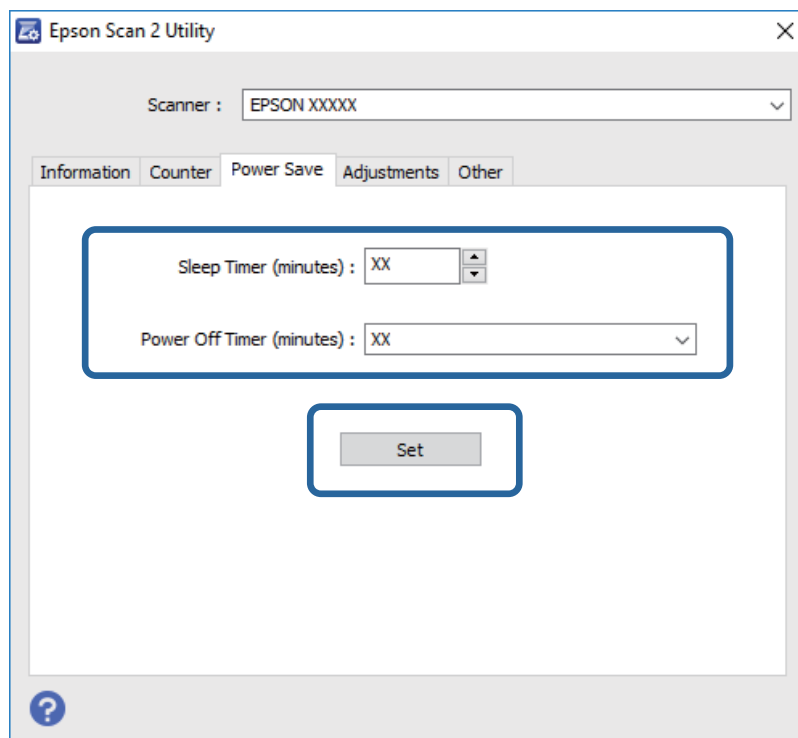

Transporting the Scanner

When you need to transport the scanner to move or for repairs, follow the steps below to pack the scanner.

Maintenance

**Caution:**

When carrying the scanner, place your hands at the bottom on both sides of the scanner, and then keep it in a horizontal position. If the scanner is tilted or placed vertically while carrying, the ADF may open. This could cause an injury.

1. Press the  button to turn off the scanner.
2. Unplug the power cord from the scanner.
3. Remove the USB cable.
4. Make sure that there is no original inside the scanner.
5. Attach the packing materials that came with the scanner, and then repack the scanner in its original box or a sturdy box.

Updating Applications and Firmware

You may be able to clear certain problems and improve or add functions by updating the applications and the firmware. Make sure you use the latest version of the applications and firmware.

1. Make sure that the scanner and the computer are connected, and the computer is connected to the internet.
2. Start EPSON Software Updater, and update the applications or the firmware.

Note:

Windows Server operating systems are not supported.

 Windows 10

Click the start button, and select **All apps > Epson Software > EPSON Software Updater**.

 Windows 8.1/Windows 8

Enter the application name in the search charm, and then select the displayed icon.

 Windows 7/Windows Vista/Windows XP

Click the start button, and then select **All Programs** or **Programs > Epson Software > EPSON Software Updater**.

 Mac OS X

Select **Finder > Go > Applications > Epson Software > EPSON Software Updater**.

**Important:**

Do not turn off the computer or the scanner while updating.

Note:

If you cannot find the application you want to update in the list, you cannot update using the EPSON Software Updater. Check for the latest versions of the applications on your local Epson website.

<http://www.epson.com>

Solving Problems

Scanner Problems

Scanner Lights Indicate an Error

Check the following if the scanner lights indicate an error.

- Make sure there are no originals jammed in the scanner.
- Make sure the scanner cover is closed.
- Make sure the scanner is connected to your computer properly.
- Make sure Epson Scan 2 is installed correctly.
- If the firmware update fails and the scanner enters recovery mode, update the firmware again using a USB connection.
- Turn off the scanner and turn it on again. If this does not solve the problem, the scanner may be malfunctioning, or the light source in the scanner unit may need to be replaced. Contact your dealer.

Related Information

- ➔ [“Error Indicators” on page 12](#)
- ➔ [“Multiple Originals Are Fed” on page 60](#)

The Scanner Does Not Turn On

- Make sure the power cord is securely connected to the scanner and an electrical outlet.
- Check that the electrical outlet is working. Plug another device into the electrical outlet and check that you can turn the power on.

Problems Starting Scanning

Cannot Start Epson Scan 2

- Make sure the scanner is connected to your computer properly.
- Make sure the USB cable is securely connected to the scanner and the computer.
- Use the USB cable that came with the scanner.
- If you are using the scanner with the Network Interface Unit, make sure the network cable is securely connected.
- Make sure the scanner is turned on.
- Wait until the status light stops flashing indicating that the scanner is ready to scan.

Solving Problems

- ❑ Connect the scanner directly to the computer's USB port. The scanner may not work properly when connected to the computer through one or more USB hubs.
- ❑ If you are using any TWAIN-compliant applications, make sure that the correct scanner is selected as the scanner or source setting.

Pressing a Scanner Button Does Not Start the Correct Application

- ❑ Make sure the scanner is connected to your computer properly.
- ❑ Make sure Epson Scan 2 and other applications are installed correctly.
- ❑ Make sure Document Capture Pro (Windows) or Document Capture (Mac OS X) is installed correctly.
- ❑ Check the correct setting is assigned to the scanner button in Document Capture Pro (Windows) or Document Capture (Mac OS X).

Related Information

➔ [“Scanning Using a Scanner Button” on page 34](#)

Paper Feeding Problems

Removing Jammed Originals from the Scanner

If an original has jammed in the ADF, follow these steps to remove it.

1. Remove all originals remaining in the input tray.
2. Open the ADF cover and remove the jammed originals.

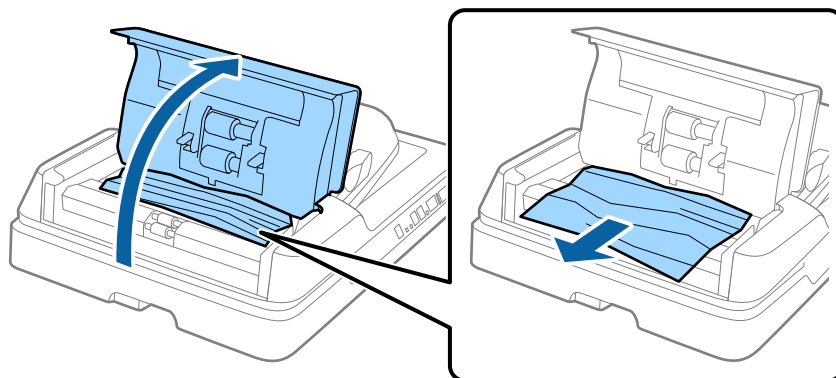

Solving Problems

3. If you cannot remove the originals, raise the ADF. Make sure the ADF cover is open while you raise the ADF.

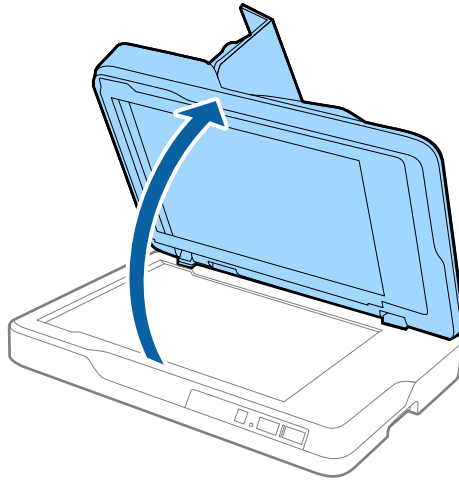

4. Remove the document mat.

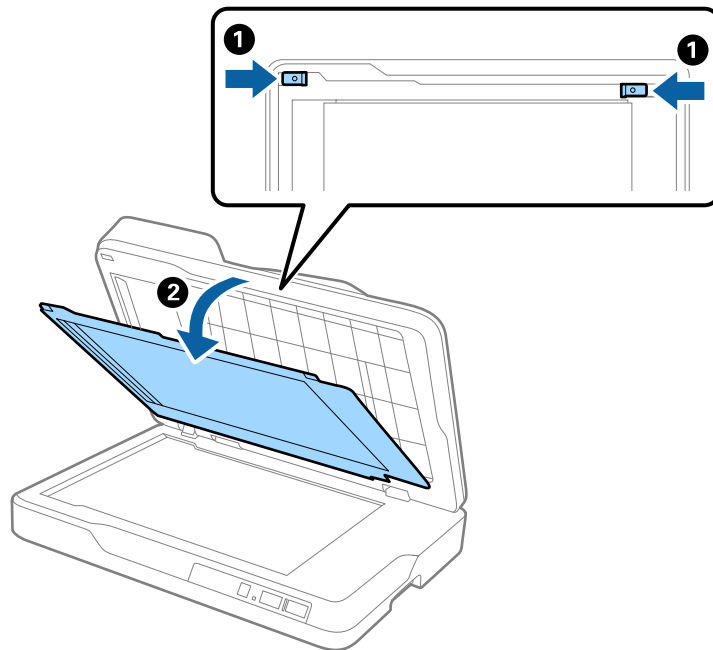

Solving Problems

- Carefully pull out any jammed originals from inside the scanner.

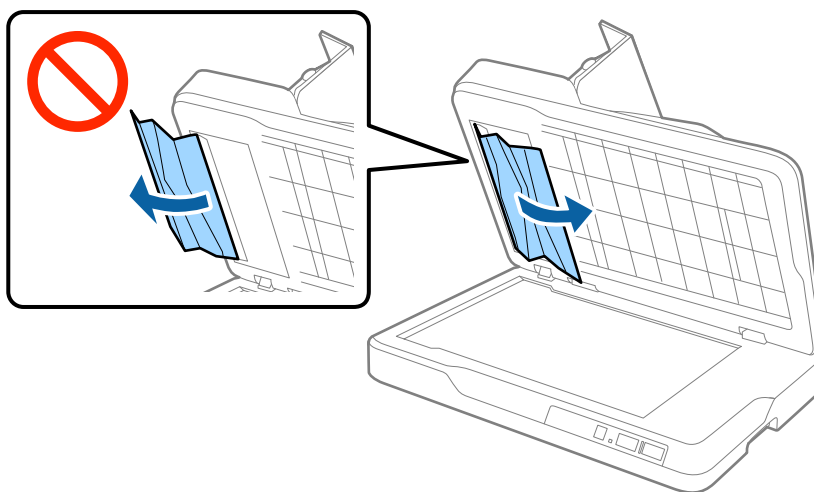

Note:

Make sure the clear part of the document mat is in the correct position.

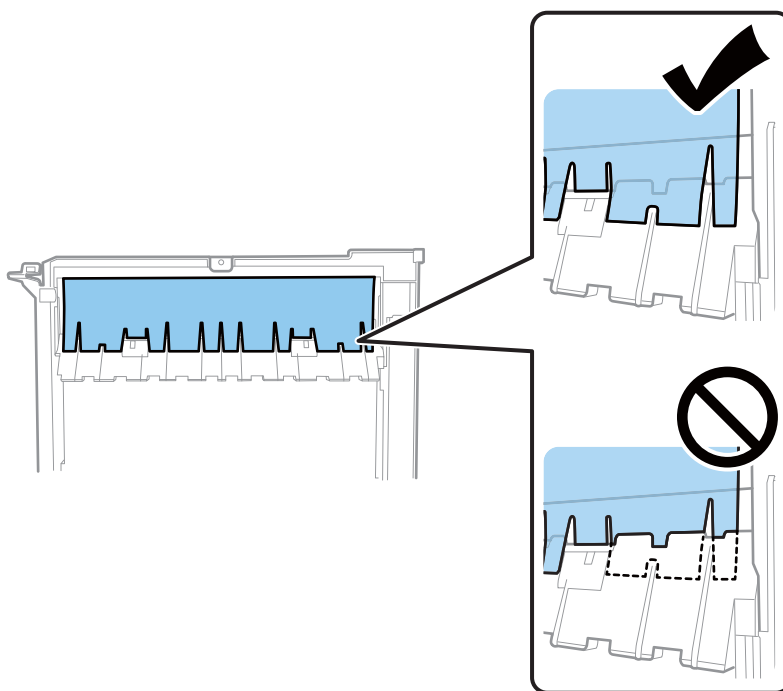

- Attach the document mat.
- Close the ADF, and then close the ADF cover.

Multiple Originals Are Fed

If multiple originals are fed frequently, try the following.

- If you load unsupported originals, the scanner may feed multiple originals at a time.
- Clean the ADF.

Solving Problems

- Reduce the number of originals being placed at a time.

Related Information

- ➔ [“Cleaning the ADF” on page 50](#)

The Originals Get Dirty

Clean the inside of the scanner.

Related Information

- ➔ [“Cleaning the ADF” on page 50](#)
- ➔ [“Cleaning the Scanner Glass” on page 53](#)

Scanning Speed Slows Down when Scanning Continuously

When scanning continuously using the ADF, scanning slows down to prevent the scanner mechanism from overheating and being damaged. However, you can continue scanning.

To regain normal scanning speed, leave the scanner idle for at least 30 minutes. Scanning speed does not recover even if the power is off.

Scanning Takes a Long Time

- When the resolution is high, scanning may take some time.
- Computers with USB 3.0 (SuperSpeed) or USB 2.0 (Hi-Speed) ports can scan faster than those with USB 1.1 ports. If you are using a USB 3.0 or USB 2.0 port with the scanner, make sure it meets the system requirements.
- When using security software, exclude the TWAIN.log file from monitoring, or set the TWAIN.log as a read-only file. For more information on your security software's functions, see the help and so on supplied with the software. The TWAIN.log file is saved in the following locations.
 - Windows 10/Windows 8.1/ Windows 8/ Windows 7/ Windows Vista:
C:\Users*(user name)*\AppData\Local\Temp
 - Windows XP:
C:\Documents and Settings*(user name)*\Local Settings\Temp

Scanned Image Problems

Uneven Colors, Dirt, Spots, and so on Appear when Scanning from the Scanner Glass

- Clean the scanner glass.
- Remove any trash or dirt that adheres to the original.

Solving Problems

- Do not press with too much force on the original or the document cover. If you press with too much force, blurring, smudges, and spots may occur.

Related Information

- ➔ [“Cleaning the Scanner Glass” on page 53](#)

Straight Lines Appear when Scanning from ADF

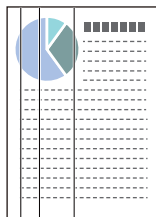

- Clean the ADF.
Straight lines may appear in the image when trash or dirt gets into the ADF.
Make sure you clean the clear parts of the document mat.
- Remove any trash or dirt that adheres to the original.

Related Information

- ➔ [“Cleaning the ADF” on page 50](#)

The Image Quality is Rough

- If the resolution is low, try increasing the resolution and then scanning.
- In Epson Scan 2, adjust the image using items on the **Advanced Settings** tab, and then scan.

Related Information

- ➔ [“Setting a Resolution That Suits the Scanning Purpose” on page 28](#)
- ➔ [“Image Adjustment Features” on page 35](#)

Offset Appears in the Background of Images

Images on the back of the original may appear in the scanned image.

- In Epson Scan 2, select the **Advanced Settings** tab, and then adjust the **Brightness**.
This feature may not be available depending on the settings on the **Main Settings** tab > **Image Type** or other settings on the **Advanced Settings** tab.
- In Epson Scan 2, select the **Advanced Settings** tab, and then **Image Option** > **Text Enhancement**.
- When scanning from the scanner glass, place black paper or a desk pad over the original.

Solving Problems

Related Information

- ➔ [“Brightness” on page 39](#)
You can adjust the brightness for the whole image.
- ➔ [“Text Enhancement” on page 37](#)
You can make blurred letters in the original clear and sharp. You can also reduce the offset or unevenness of the background.

Text is Blurred

- In Epson Scan 2, select the **Advanced Settings** tab, and then **Image Option > Text Enhancement**.
- In Epson Scan 2, when **Image Type** on the **Main Settings** tab is set to **Black & White**, adjust the **Threshold** on the **Advanced Settings** tab. When you increase the **Threshold**, black becomes stronger.
- If the resolution is low, try increasing the resolution and then scanning.

Related Information

- ➔ [“Text Enhancement” on page 37](#)
You can make blurred letters in the original clear and sharp. You can also reduce the offset or unevenness of the background.
- ➔ [“Threshold” on page 40](#)
You can adjust the border for monochrome binary (black and white). Increase the threshold, the black color area becomes larger. Decrease the threshold, the white color area becomes larger.
- ➔ [“Setting a Resolution That Suits the Scanning Purpose” on page 28](#)

Moiré Patterns (Web-Like Shadows) Appear

If the original is a printed document, moiré patterns (web-like shadows) may appear in the scanned image.

- On the **Advanced Settings** tab in Epson Scan 2, select **Descreening**.



- Change the resolution, and then scan again.

Related Information

- ➔ [“Descreening” on page 37](#)
You can remove moiré patterns (web-like shadows) that appear when scanning printed paper such as a magazine.
- ➔ [“Setting a Resolution That Suits the Scanning Purpose” on page 28](#)

Cannot Scan the Correct Area on the Scanner Glass

- Make sure the original is placed correctly against the alignment marks.
- If the edge of the scanned image is missing, move the original slightly away from the edge of the scanner glass.

The Edge of the Original is Not Scanned when Automatically Detecting the Size of the Original

- In Epson Scan 2, select the **Main Settings** tab, and then select **Document Size > Settings**. On the **Document Size Settings** window, adjust **Crop Margins for Size "Auto"**.
- Depending on the original, the area of the original may not be detected correctly when using the **Auto Detect** feature. Select the appropriate size of the original from the **Document Size** list.

Note:

If the size of the original you want to scan is not on the list, select **Customize**, and then create the size manually.

Text is Not Recognized Correctly when Saving as a Searchable PDF

- On the **Image Format Options** window in Epson Scan 2, check that **Text Language** is set correctly on the **Text** tab.
- Check that the original is placed straight.
- Use an original with clear text. Text recognition may decline for the following types of originals.
 - Originals that have been copied a number of times
 - Originals received by fax (at low resolutions)
 - Originals on which the letter spacing or line spacing is too small
 - Originals with ruled lines or underlining over the text
 - Originals with hand-written text
 - Originals with creases or wrinkles
- In Epson Scan 2, when **Image Type** on the **Main Settings** tab is set to **Black & White**, adjust the **Threshold** on the **Advanced Settings** tab. When you increase the **Threshold**, the black color area becomes larger.
- In Epson Scan 2, select the **Advanced Settings** tab, and then **Image Option > Text Enhancement**.

Related Information

➔ [“Saving as a Searchable PDF” on page 42](#)

➔ [“Text Enhancement” on page 37](#)

You can make blurred letters in the original clear and sharp. You can also reduce the offset or unevenness of the background.

➔ [“Threshold” on page 40](#)

You can adjust the border for monochrome binary (black and white). Increase the threshold, the black color area becomes larger. Decrease the threshold, the white color area becomes larger.

Binding Margins of a Booklet are Distorted or Blurred

When scanning a booklet on the scanner glass, characters may appear distorted or blurred on the binding margin. If this problem occurs, text is not recognized correctly when you save the scanned image as a **Searchable PDF**.

To decrease distortion or blurring on the binding margin, gently press down the document cover and hold it down while scanning to flatten the booklet. Make sure you do not move the booklet while scanning.

 **Important:**

Do not press the document cover with too much force. Otherwise, the booklet or the scanner may be damaged.

Cannot Solve Problems in the Scanned Image

If you have tried all of the solutions and have not solved the problem, initialize the Epson Scan 2 settings using Epson Scan 2 Utility.

Note:

Epson Scan 2 Utility is an application that comes with Epson Scan 2.

1. Start Epson Scan 2 Utility.
 - Windows 10
Click the start button, and then select **All apps > EPSON > Epson Scan 2 Utility**.
 - Windows 8.1/Windows 8/Windows Server 2012 R2/Windows Server 2012
Enter the application name in the search charm, and then select the displayed icon.
 - Windows 7/Windows Vista/Windows XP/Windows Server 2008 R2/Windows Server 2008/Windows Server 2003 R2/Windows Server 2003
Click the start button, and then select **All Programs or Programs > EPSON > Epson Scan 2 > Epson Scan 2 Utility**.
 - Mac OS X
Select **Go > Applications > Epson Software > Epson Scan 2 Utility**.
2. Select the **Other** tab.
3. Click **Reset**.

Note:

If initialization does not solve the problem, uninstall and re-install Epson Scan 2.

Uninstalling and Installing Applications

Uninstalling Your Applications

You may need to uninstall and then reinstall your applications to solve certain problems or if you upgrade your operating system. Log on to your computer as an administrator. Enter the administrator password if the computer prompts you.

Uninstalling Your Applications for Windows

1. Quit all running applications.
2. Disconnect the scanner from your computer.
3. Open the Control Panel:
 - Windows 10
Right-click the start button or press and hold it, and then select **Control Panel**.
 - Windows 8.1/Windows 8/Windows Server 2012 R2/Windows Server 2012
Select **Desktop > Settings > Control Panel**.
 - Windows 7/Windows Vista/Windows XP/Windows Server 2008 R2/Windows Server 2008/Windows Server 2003 R2/Windows Server 2003
Click the start button and select **Control Panel**.
4. Open **Uninstall a program** (or **Add or Remove Programs**):
 - Windows 10/Windows 8.1/Windows 8/Windows 7/Windows Vista/Windows Server 2012 R2/Windows Server 2012/Windows Server 2008 R2/Windows Server 2008
Select **Uninstall a program** in **Programs**.
 - Windows XP/Windows Server 2003 R2/Windows Server 2003
Click **Add or Remove Programs**.
5. Select the application you want to uninstall.
6. Uninstall the applications:
 - Windows 10/Windows 8.1/Windows 8/Windows 7/Windows Vista/Windows Server 2012 R2/Windows Server 2012/Windows Server 2008 R2/Windows Server 2008
Click **Uninstall/Change** or **Uninstall**.
 - Windows XP/Windows Server 2003 R2/Windows Server 2003
Click **Change/Remove** or **Remove**.

Note:

If the User Account Control window is displayed, click Continue.

7. Follow the on-screen instructions.

Note:

*A message may be displayed prompting you to restart your computer. If it is displayed, make sure **I want to restart my computer now** is selected, and then click **Finish**.*

Uninstalling Your Applications for Mac OS X

Note:

Make sure you installed EPSON Software Updater.

1. Download the Uninstaller using EPSON Software Updater.
Once you have downloaded the Uninstaller, you do not need to download it again each time you uninstall the application.

Solving Problems

2. Disconnect the scanner from your computer.
3. To uninstall the scanner driver, select **System Preferences** from the  menu > **Printers & Scanners** (or **Print & Scan, Print & Fax**), and then remove the scanner from the enabled scanner list.
4. Quit all running applications.
5. Select **Finder > Go > Applications > Epson Software > Uninstaller**.
6. Select the application you want to uninstall, and then click Uninstall.

**Important:**

The Uninstaller removes all drivers for Epson scanners on the computer. If you use multiple Epson scanners and you only want to delete some of the drivers, delete all of them first, and then install the necessary scanner drivers again.

Note:

*If you cannot find the application you want to uninstall in the application list, you cannot uninstall using the Uninstaller. In this situation, select **Finder > Go > Applications > Epson Software**, select the application you want to uninstall, and then drag it to the trash icon.*

Installing Your Applications

Follow the steps below to install the necessary applications.

Note:

- Log on to your computer as an administrator. Enter the administrator password if the computer prompts you.
- When reinstalling applications, you need to uninstall them first.

1. Quit all running applications.
2. When installing Epson Scan 2, disconnect the scanner and the computer temporarily.

Note:

Do not connect the scanner and the computer until you are instructed to do so.

3. Install the application by following the instructions on the Website below.

<http://epson.sn>

Note:

For Windows, you can also use the software disc that came with the scanner.

Technical Specifications

General Scanner Specifications

Note:

Specifications are subject to change without notice.

Scanner type	Flatbed color scanner with ADF
Photoelectric device	CIS
Light source	RGB LED
Scanning resolution	ADF : 600 dpi (main scan), 600 dpi (sub scan) Scanner glass : 1,200 dpi (main scan), 1,200 dpi (sub scan)
Output resolution	ADF: 50 to 600 dpi (127 to 393.7 mm (5.0 to 15.5 in.) in length), 50 to 300 dpi (393.7 to 3,048 mm (15.5 to 120.0 in.) in length) Scanner glass: 50 to 1,200 dpi (in 1 dpi increments)
Document Size	ADF double sided <input type="checkbox"/> Max 215.9×297 mm (8.5×11.7 inches) <input type="checkbox"/> Min 89×170 mm (3.5×6.7 inches) ADF single sided <input type="checkbox"/> Max 215.9×393.7 mm (8.5×15.5 inches) <input type="checkbox"/> Min 89×127 mm (3.5×5.0 inches) ADF single sided long paper mode (300 dpi) <input type="checkbox"/> Max 215.9×3,048 mm (8.5×120.0 inches) <input type="checkbox"/> Min 89×393.7 mm (3.5×15.5 inches) Scanner glass <input type="checkbox"/> Max 215.9×297 mm (8.5×11.7 inches)
Paper input	Face-up loading
Paper output	Face-down ejection
Paper capacity	50 sheets of paper at 80 g/m ²
Color Depth	Color <input type="checkbox"/> 30 bits per pixel internal (10 bits per pixel per color internal) <input type="checkbox"/> 24 bits per pixel external (8 bits per pixel per color external) Grayscale <input type="checkbox"/> 10 bits per pixel internal <input type="checkbox"/> 8 bits per pixel external Black and white <input type="checkbox"/> 10 bits per pixel internal <input type="checkbox"/> 1 bits per pixel external

Technical Specifications

Interface *	SuperSpeed USB Ethernet 1000BASE-T/100BASE-TX/10BASE-T (option)
-------------	--

* Simultaneous use (simultaneous access) of a USB and a network connection is not allowed.

Dimensional Specifications

Dimensions *	Width: 450 mm (17.7 inches) Depth: 318 mm (12.5 inches) Height: 121 mm (4.8 inches)
Weight	Approx. 4.1 kg (9.0 lb)

* Without protruding parts.

Electrical Specifications

Model	AC 100 to 240V Model	AC 220 to 240V Model
Rated Frequency Range	50 to 60 Hz	50 to 60 Hz
Rated Current	0.3 to 0.2A	0.2 A
Power Consumption	USB Connection <input type="checkbox"/> Operating: Approx. 11 W <input type="checkbox"/> Ready mode: Approx. 5.8 W <input type="checkbox"/> Sleep mode : Approx. 0.8 W <input type="checkbox"/> Power off: Approx. 0.15 W	USB Connection <input type="checkbox"/> Operating: Approx. 11 W <input type="checkbox"/> Ready mode: Approx. 6.2 W <input type="checkbox"/> Sleep mode : Approx. 0.9 W <input type="checkbox"/> Power off: Approx. 0.25 W

Note:

Check the label on the scanner for its voltage.

Environmental Specifications

Temperature	When operating	10 to 35 °C (50 to 95 °F)
	When stored	-20 to 60 °C (-4 to 140 °F)
Humidity	When operating	20 to 80% (without condensation)
	When stored	20 to 80% (without condensation)

Technical Specifications

Operation Sound	Sound power level	6.77 B (ADF) 4.65 B (Scanner glass)
	Sound pressure level	55 dB (ADF) 35 dB (Scanner glass)
Operating conditions		Ordinary office or home conditions. Avoid operating the scanner in direct sunlight, near a strong light source, or in extremely dusty conditions.

System Requirements

Windows	<p>Windows 10 (32-bit, 64-bit)</p> <p>Windows 8.1 (32-bit, 64-bit)</p> <p>Windows 8 (32-bit, 64-bit)</p> <p>Windows 7 (32-bit, 64-bit)</p> <p>Windows Vista (32-bit, 64-bit)</p> <p>Windows XP Professional x64 Edition Service Pack 2</p> <p>Windows XP (32-bit) Service Pack 3</p> <p>Windows Server 2012 R2</p> <p>Windows Server 2012</p> <p>Windows Server 2008 R2</p> <p>Windows Server 2008 (32-bit, 64-bit)</p> <p>Windows Server 2003 R2 (32-bit, 64-bit)</p> <p>Windows Server 2003 (32-bit, 64-bit) Service Pack 2</p>
Mac OS X *1 *2	<p>Mac OS X v10.11.x</p> <p>Mac OS X v10.10.x</p> <p>Mac OS X v10.9.x</p> <p>Mac OS X v10.8.x</p> <p>Mac OS X v10.7.x</p> <p>Mac OS X v10.6.8</p>

*1 Fast User Switching on Mac OS X or later is not supported.

*2 The UNIX File System (UFS) for Mac OS X is not supported.

Standards and Approvals

Standards and Approvals for U.S. Model

Safety	UL60950-1 CAN/CSA-C22.2 No. 60950-1
EMC	FCC Part 15 Subpart B Class B CAN/CSA-CEI/IEC CISPR22 Class B

Standards and Approvals for European Model

The following model is CE marked and in compliance with all the applicable EU Directives. For further details, visit the following website to access the full declaration of conformities containing reference to the Directives and harmonized standards used to declare conformity.

<http://www.epson.eu/conformity>

J411B

Standards and Approvals for Australian Model

Safety	AS/NZS 60950.1
EMC	AS/NZS CISPR22 Class B

Where to Get Help

Technical Support Web Site

If you need further help, visit the Epson support website shown below. Select your country or region and go to the support section of your local Epson website. The latest drivers, FAQs, manuals, or other downloadables are also available from the site.

<http://support.epson.net/>

<http://www.epson.eu/Support> (Europe)

If your Epson product is not operating properly and you cannot solve the problem, contact Epson support services for assistance.

Contacting Epson Support

Before Contacting Epson

If your Epson product is not operating properly and you cannot solve the problem using the troubleshooting information in your product manuals, contact Epson support services for assistance. If Epson support for your area is not listed below, contact the dealer where you purchased your product.

Epson support will be able to help you much more quickly if you give them the following information:

- Product serial number
(The serial number label is usually on the back of the product.)
- Product model
- Product software version
(Click **About**, **Version Info**, or a similar button in the product software.)
- Brand and model of your computer
- Your computer operating system name and version
- Names and versions of the software applications you normally use with your product

Note:

Depending on the product, the dial list data for fax and/or network settings may be stored in the product's memory. Due to breakdown or repair of a product, data and/or settings may be lost. Epson shall not be responsible for the loss of any data, for backing up or recovering data and/or settings even during a warranty period. We recommend that you make your own backup data or take notes.

Help for Users in Europe

Check your Pan-European Warranty Document for information on how to contact Epson support.

Where to Get Help

Help for Users in Taiwan

Contacts for information, support, and services are:

World Wide Web

<http://www.epson.com.tw>

Information on product specifications, drivers for download, and products enquiry are available.

Epson HelpDesk

Phone: +886-2-2165-3138

Our HelpDesk team can help you with the following over the phone:

- Sales enquiries and product information
- Product usage questions or problems
- Enquiries on repair service and warranty

Repair service center:

<http://www.tekcare.com.tw/branchMap.page>

TekCare corporation is an authorized service center for Epson Taiwan Technology & Trading Ltd.

Help for Users in Australia

Epson Australia wishes to provide you with a high level of customer service. In addition to your product manuals, we provide the following sources for obtaining information:

Internet URL

<http://www.epson.com.au>

Access the Epson Australia World Wide Web pages. Worth taking your modem here for the occasional surf! The site provides a download area for drivers, Epson contact points, new product information and technical support (e-mail).

Epson Helpdesk

Phone: 1300-361-054

Epson Helpdesk is provided as a final backup to make sure our clients have access to advice. Operators on the Helpdesk can aid you in installing, configuring and operating your Epson product. Our Pre-sales Helpdesk staff can provide literature on new Epson products and advise where the nearest dealer or service agent is located. Many types of queries are answered here.

We encourage you to have all the relevant information on hand when you ring. The more information you prepare, the faster we can help solve the problem. This information includes your Epson product manuals, type of computer, operating system, application programs, and any information you feel is required.

Transportation of Product

Epson recommends retaining product packaging for future transportation.

Where to Get Help

Help for Users in Singapore

Sources of information, support, and services available from Epson Singapore are:

World Wide Web

<http://www.epson.com.sg>

Information on product specifications, drivers for download, Frequently Asked Questions (FAQ), Sales Enquiries, and Technical Support via e-mail are available.

Epson HelpDesk

Toll Free: 800-120-5564

Our HelpDesk team can help you with the following over the phone:

- Sales enquiries and product information
- Product usage questions or problem troubleshooting
- Enquiries on repair service and warranty

Help for Users in Thailand

Contacts for information, support, and services are:

World Wide Web

<http://www.epson.co.th>

Information on product specifications, drivers for download, Frequently Asked Questions (FAQ), and e-mail are available.

Epson Call Centre

Phone: 66-2460-9699

Email: support@eth.epson.co.th

Our Call Centre team can help you with the following over the phone:

- Sales enquiries and product information
- Product usage questions or problems
- Enquiries on repair service and warranty

Help for Users in Vietnam

Contacts for information, support, and services are:

Epson Hotline

Phone(Ho Chi Minh City): 84-8-823-9239

Phone(Hanoi City): 84-4-3978-4785, 84-4-3978-4775

Where to Get Help

Epson Service Center

65 Truong Dinh Street, District 1, Ho Chi Minh City, Vietnam.

29 Tue Tinh, Quan Hai Ba Trung, Hanoi City, Vietnam

Help for Users in Indonesia

Contacts for information, support, and services are:

World Wide Web

<http://www.epson.co.id>

- Information on product specifications, drivers for download
- Frequently Asked Questions (FAQ), Sales Enquiries, questions through e-mail

Epson Hotline

Phone: 62-1500-766

Fax: 62-21-808-66-799

Our Hotline team can help you with the following over the phone or fax:

- Sales enquiries and product information
- Technical support

Epson Service Center

Province	Company Name	Address	Phone E-mail
DKI JAKARTA	ESS Jakarta MG. DUA	RUKO MANGGA DUA MALL NO. 48 JL. ARTERI MANGGA DUA - JAKARTA UTARA-DKI	(+6221)62301104 jkt-technical1@epson-indonesia.co.id
NORTH SUMATERA	ESC Medan	Kompleks Graha Niaga, Jl. Bambu II No. A-4, Medan- 20114	(+6261)42066090/42066091 mdn-technical@epson-indonesia.co.id
WEST JAWA	ESC Bandung	JL. CIHAMPELAS NO. 48A-BANDUNG JABAR 40116	(+6222)4207033 bdg-technical@epson-indonesia.co.id
DI YOGYAKARTA	ESC Yogyakarta	YAP Square, Blok A No.6 Jl. C Simanjutak YOGYAKARTA - DIY	(+62274)581065 ygy-technical@epson-indonesia.co.id
EAST JAWA	ESC Surabaya	HITECH MALL LT.2 BLOK A NO. 24 JL. KUSUMA BANGSA NO. 116 -118 - SURABAYA JATIM	(+6231)5355035 sby-technical@epson-indonesia.co.id
SOUTH SULAWESI	ESC Makassar	JL. GUNUNG BAWAKARAENG NO. 68E - MAKASSAR SULSEL	(+62411)328212 mksr-technical@epson-indonesia.co.id

Where to Get Help

Province	Company Name	Address	Phone E-mail
WEST KALIMANTAN	ESC Pontianak	JL. NUSA INDAH I NO. 40A PONTIANAK KALBAR 78117	(+62561)735507 pontianak-technical@epson-indonesia.co.id
PEKANBARU	ESC PEKANBARU	JL. TUANKU TAMBUSAI NO. 353 - PEKANBARU RIAU	(+62761)21420 pkb-technical@epson-indonesia.co.id
DKI JAKARTA	ESS JAKARTA KEIAI	WISMA KEIAI LT. 1 JL. JEND. SUDIRMAN KAV. 3 JAKPUS DKI JAKARTA	(+6221)5724335 ess.support@epson-indonesia.co.id
EAST JAWA	ESS SURABAYA	JL. JAWA NO. 2-4 KAV. 29, RUKO SURYA INTI, SURABAYA - JATIM	(+6231)5014949 esssby.support@epson-indonesia.co.id
BANTEN	ESS SERPONG	Ruko mall WTC MATAHARI no. 953 SERPONG - Banten	(+6221)53167051 esstag.support@epson-indonesia.co.id
CENTRAL JAWA	ESS SEMARANG	Komplek Ruko Metro Plaza Blok C20 , Jl. MT Haryono No 970 Semarang - Jawa tengah	(+6224)8313807 esssmg.support@epson-indonesia.co.id
EAST KALIMANTAN	ESC SAMARINDA	Jl. KH. Wahid Hasyim (M. Yamin) Kel. Sempaja Selatan Kec. Samarinda Utara Samarinda- Kalimantan Timur (samping kantor pos)	(+62541)7272904 escsmd.support@epson-indonesia.co.id
SOUTH SUMATERA	ESC PALEMBANG	Jl. H.M. Rasyid Nawawi no.249, kelurahan 9 ilir Palembang - Sumsel	(+62711)311330 escplg.support@epson-indonesia.co.id
EAST JAVA	ESC JEMBER	Jl. Panglima Besar Sudirman No.1 D JEMBER - JAWA TIMUR (Depan Balai Penelitian dan Pengolahan Kakao)	(+62331) 486468,488373 jmr-admin@epson-indonesia.co.id jmr-technical@epson-indonesia.co.id
NORTH SULAWESI	ESC MANADO	Tekno @Megamall, Megamall LG TK-21 Jl. Piere Tendean Kawasan Megamas Boulevard Manado 95111	(+62431)7210033 MND-ADMIN@EPSON-INDONESIA.CO.ID

For other cities not listed here, call the Hot Line: 08071137766.

Help for Users in Hong Kong

To obtain technical support as well as other after-sales services, users are welcome to contact Epson Hong Kong Limited.

Where to Get Help

Internet Home Page

<http://www.epson.com.hk>

Epson Hong Kong has established a local home page in both Chinese and English on the Internet to provide users with the following information:

- Product information
- Answers to Frequently Asked Questions (FAQs)
- Latest versions of Epson product drivers

Technical Support Hotline

You can also contact our technical staff at the following telephone and fax numbers:

Phone: 852-2827-8911

Fax: 852-2827-4383

Help for Users in Malaysia

Contacts for information, support, and services are:

World Wide Web

<http://www.epson.com.my>

- Information on product specifications, drivers for download
- Frequently Asked Questions (FAQ), Sales Enquiries, questions through e-mail

Epson Call Centre

Phone: +60 1800-8-17349

- Sales enquiries and product information
- Product usage questions or problems
- Enquiries on repair services and warranty

Head Office

Phone: 603-56288288

Fax: 603-5628 8388/603-5621 2088

Help for Users in India

Contacts for information, support, and services are:

World Wide Web

<http://www.epson.co.in>

Information on product specifications, drivers for download, and products enquiry are available.

Where to Get Help

Helpline

- Service, product information, and ordering consumables (BSNL Lines)
Toll-free number: 18004250011
Accessible 9am to 6pm, Monday through Saturday (Except public holidays)
- Service (CDMA & Mobile Users)
Toll-free number: 186030001600
Accessible 9am to 6pm, Monday through Saturday (Except public holidays)

Help for Users in the Philippines

To obtain technical support as well as other after sales services, users are welcome to contact the Epson Philippines Corporation at the telephone, fax numbers and e-mail address below:

World Wide Web

<http://www.epson.com.ph>

Information on product specifications, drivers for download, Frequently Asked Questions (FAQ), and E-mail Enquiries are available.

Epson Philippines Customer Care

Toll Free: (PLDT) 1800-1069-37766

Toll Free: (Digital) 1800-3-0037766

Metro Manila: (+632)441-9030

Web Site: <http://customercare.epson.com.ph>

E-mail: customercare@epc.epson.com.ph

Our Customer Care team can help you with the following over the phone:

- Sales enquiries and product information
- Product usage questions or problems
- Enquiries on repair service and warranty

Epson Philippines Corporation

Trunk Line: +632-706-2609

Fax: +632-706-2665