

ET-2750 / L4160 Series User's Guide

Contents

About This Manual

Introduction to the Manuals.	6
Using the Manual to Search for Information.	6
Marks and Symbols.	8
Descriptions Used in this Manual.	8
Operating System References.	8

Important Instructions

Safety Instructions.	10
Safety Instructions for Ink.	10
Printer Advisories and Warnings.	11
Advisories and Warnings for Setting Up the Printer.	11
Advisories and Warnings for Using the Printer.	11
Advisories and Warnings for Transporting or Storing the Printer.	12
Advisories and Warnings for Using the Printer with a Wireless Connection.	12
Advisories and Warnings for Using Memory Cards.	12
Advisories and Warnings for Using the LCD Screen.	12
Protecting Your Personal Information.	13

Printer Basics

Part Names and Functions.	14
Control Panel.	16
Guide to the LCD Screen.	16
Guide to the Home Screen.	17
Entering Characters.	18

Network Settings

Network Connection Types.	21
Wi-Fi Connection.	21
Wi-Fi Direct (Simple AP) Connection.	21
Connecting to a Computer.	22
Connecting to a Smart Device.	23
Making Wi-Fi Settings from the Printer.	23
Making Wi-Fi Settings Manually.	24
Making Wi-Fi Settings by Push Button Setup.	25
Making Wi-Fi Settings by PIN Code Setup (WPS).	26
Making Wi-Fi Direct (Simple AP) Connection Settings.	26

Checking the Network Connection Status.	27
Network Icon.	27
Printing a Network Connection Report.	27
Printing a Network Status Sheet.	34
Replacing or Adding New Access Points.	34
Changing the Connection Method to a Computer.	34
Disabling Wi-Fi from the Control Panel.	35
Disconnecting Wi-Fi Direct (Simple AP) connection from the Control Panel.	36
Restoring the Network Settings from the Control Panel.	36

Preparing the Printer

Loading Papers.	37
Available Paper and Capacities.	37
Loading Paper in the Rear Paper Feed.	39
Loading Envelopes and Precautions.	41
Loading Long Papers.	42
List of Paper Type.	42
Placing Originals.	43
Placing Originals on the Scanner Glass.	43
Inserting a Memory Card.	44
Supported Memory Cards.	44
Inserting and Removing a Memory Card.	45
Accessing a Memory Card From a Computer.	46
Menu Options for Settings.	46
Menu Options for Maintenance.	47
Menu Options for Printer Setup.	47
Menu Options for Network Settings.	49
Menu Options for Epson Connect Services.	50
Menu Options for Google Cloud Print Services.	51
Menu Options for File Sharing.	51
Menu Options for Print Status Sheet.	51
Menu Options for Print Counter.	52
Menu Options for Firmware Update.	52
Menu Options for Restore Default Settings.	52
Saving Power.	53
Saving Power - Control Panel.	53

Printing

Printing from the Printer Driver on Windows.	54
Accessing the Printer Driver.	54
Printing Basics.	54
Printing on 2-Sides.	56
Printing Several Pages on One Sheet.	57

Contents

Printing and Stacking in Page Order (Reverse Order Printing)	58	Scanning to a Computer (WSD).	92
Printing a Reduced or Enlarged Document.	58	Scanning from a Computer.	95
Printing One Image on Multiple Sheets for Enlargement (Creating a Poster).	59	Scanning Using Epson Scan 2.	95
Printing with a Header and Footer.	65	Scanning from Smart Devices.	98
Printing a Watermark.	66	Installing Epson iPrint.	98
Printing Multiple Files Together.	66	Scanning Using Epson iPrint.	98
Printing Using the Color Universal Print Feature.	67		
Adjusting the Print Color.	68	Refilling Ink	
Printing to Emphasize Thin Lines.	68	Checking the Ink Levels.	100
Printing Clear Bar Codes.	69	Checking the Ink Levels - Windows.	100
Canceling Printing.	69	Checking the Ink Levels - Mac OS.	100
Menu Options for the Printer Driver.	70	Ink Bottle Codes.	101
Printing from the Printer Driver on Mac OS.	72	Ink Bottle Handling Precautions.	101
Printing Basics.	72	Refilling the Ink Tanks.	102
Printing on 2-Sides.	74		
Printing Several Pages on One Sheet.	75	Maintaining the Printer	
Printing and Stacking in Page Order (Reverse Order Printing).	75	Checking and Cleaning the Print Head.	107
Printing a Reduced or Enlarged Document.	76	Checking and Cleaning the Print Head - Control Panel.	107
Adjusting the Print Color.	77	Checking and Cleaning the Print Head - Windows.	108
Canceling Printing.	77	Checking and Cleaning the Print Head - Mac OS.	108
Menu Options for the Printer Driver.	77	Running Power Cleaning.	108
Making Operation Settings for the Mac OS Printer Driver.	79	Running Power Cleaning - Control Panel.	109
Printing from the Control Panel.	80	Running Power Cleaning - Windows.	109
Printing Photos by Selecting from a Memory Card.	80	Running Power Cleaning - Mac OS.	110
Printing Lined Paper, Calendars, and Original Writing Paper.	81	Aligning the Print Head.	110
Menu Options for Print Photos.	81	Aligning the Print Head - Control Panel.	110
Printing from Smart Devices.	82	Cleaning the Paper Path.	111
Using Epson iPrint.	82	Cleaning the Paper Path for Ink Smears.	111
Using Epson Print Enabler.	84	Cleaning the Scanner Glass.	112
Using AirPrint.	84	Cleaning the Translucent Film.	113
Canceling the Ongoing Job.	85	Cleaning the Printer.	115
		Checking the Total Number of Pages Fed Through the Printer.	116
		Checking the Total Number of Pages Fed Through the Printer - Control Panel.	116
		Checking the Total Number of Pages Fed Through the Printer - Windows.	117
		Checking the Total Number of Pages Fed Through the Printer - Mac OS.	117
Copying			
Copying.	86		
Copying on 2-Sides.	87		
Copying Multiple Originals onto One Sheet.	87		
Menu Options for Copying.	87		
Scanning			
Scanning Using the Control Panel.	90	Network Service and Software Information	
Scanning to a Memory Card.	90	Application for Configuring Printer Operations (Web Config).	118
Scanning to a Computer (Event Manager).	91		

Contents

Running Web Config on a Web Browser.	118	Checking the Software and Data.	135
Running Web Config on Windows.	119	Checking the Printer Status from the Computer (Windows).	137
Running Web Config on Mac OS.	119	Checking the printer status from the computer (Mac OS).	137
Application for Scanning Documents and Images (Epson Scan 2).	119	When You Cannot Make Network Settings.	138
Adding the Network Scanner.	120	Cannot Connect from Devices Even Though Network Settings are No Problems.	138
Application for Configuring Scanning Operations from the Control Panel (Epson Event Manager).	120	Checking the SSID Connected to the Printer.	140
Application for Laying Out Photos (Epson Easy Photo Print).	121	Checking the SSID for the Computer.	140
Application for Printing Web Pages (E-Web Print)	122	Cannot Print from an iPhone or iPad.	141
Application for Updating Software and Firmware (EPSON Software Updater).	122	Printout Problems.	141
Installing the Latest Applications.	123	Printout is Scuffed or Color is Missing.	141
Updating the Printer's Firmware using the Control Panel.	124	Banding or Unexpected Colors Appear.	142
Uninstalling Applications.	124	Colored Banding Appears at Intervals of Approximately 2.5 cm.	142
Uninstalling Applications - Windows.	124	Blurry Prints, Vertical Banding, or Misalignment.	143
Uninstalling Applications - Mac OS.	125	Print Quality is Poor.	143
Printing Using a Network Service.	126	Paper Is Smearred or Scuffed.	144
		Paper is Smearred During Automatic 2-Sided Printing.	145
		Printed Photos are Sticky.	146
		Images or Photos are Printed in Unexpected Colors.	146
		Cannot Print Without Margins.	146
		Edges of the Image are Cropped During Borderless Printing.	146
		The Position, Size, or Margins of the Printout Are Incorrect.	147
		Printed Characters Are Incorrect or Garbled.	147
		The Printed Image Is Inverted.	147
		Mosaic-Like Patterns in the Prints.	148
		Uneven Colors, Smears, Dots, or Straight Lines Appear in the Copied Image.	148
		Moiré (Cross-Hatch) Patterns Appear in the Copied Image.	148
		An Image of the Reverse Side of the Original Appears in the Copied Image.	148
		The Printout Problem Could Not be Cleared.	148
		Other Printing Problems.	149
		Printing Is Too Slow.	149
		Printing Slows Down Dramatically During Continuous Printing.	149
		Cannot Cancel Printing from a Computer Running Mac OS X v10.6.8.	149
		Cannot Start Scanning.	150
		Scanned Image Problems.	150
		Uneven Colors, Dirt, Spots, and so on Appear when Scanning from the Scanner Glass.	150
		The Image Quality Is Rough.	151
Solving Problems			
Checking the Printer Status.	127		
Checking Error Codes on the LCD Screen.	127		
Checking the Printer Status - Windows.	128		
Checking the Printer Status - Mac OS.	128		
Checking the Software Status.	128		
Removing Jammed Paper.	129		
Removing Jammed Paper from the Rear Paper Feed.	129		
Removing Jammed Paper from Inside the Printer.	129		
Removing Jammed Paper from Rear Cover.	131		
Paper Does Not Feed Correctly.	132		
Paper Jams.	132		
Paper Feeds at a Slant.	133		
Several Sheets of Paper are Fed at a Time.	133		
Paper Out Error Occurs.	133		
Paper is Ejected During Printing.	133		
Power and Control Panel Problems.	133		
Power Does Not Turn On.	133		
Power Does Not Turn Off.	133		
Power Turns Off Automatically.	133		
LCD Screen Gets Dark.	134		
Cannot Print from a Computer.	134		
Checking the Connection (USB).	134		
Checking the Connection (Network).	134		

Contents

Offset Appears in the Background of Images. . .	151
Text is Blurred.	151
Moiré Patterns (Web-Like Shadows) Appear. . .	151
Cannot Scan the Correct Area on the Scanner Glass.	152
Text is Not Recognized Correctly when Saving as a Searchable PDF.	152
Cannot Solve Problems in the Scanned Image. .	153
Other Scanning Problems.	153
Scanning Speed Is Slow.	153
Scanning Stops when Scanning to PDF/ Multi-TIFF.	154
Other Problems.	154
Slight Electric Shock when Touching the Printer.	154
Operation Sounds Are Loud.	154
Cannot Save Data to a Memory Device.	154
Application Is Blocked by a Firewall (for Windows Only).	155
"?" Is Displayed on the Photo Selection Screen. .	155
A Message Prompting You to Reset the Ink Levels is Displayed.	155
Ink Spilled.	155

Appendix

Technical Specifications.	156
Printer Specifications.	156
Scanner Specifications.	157
Interface Specifications.	157
Network Function List.	158
Wi-Fi Specifications.	158
Security Protocol.	159
Supported Third Party Services.	159
External Storage Device Specifications.	159
Dimensions.	160
Electrical Specifications.	160
Environmental Specifications.	161
System Requirements.	161
Regulatory Information.	162
Standards and Approvals.	162
Restrictions on Copying.	163
Transporting and Storing the Printer.	163
Copyright.	167
Trademarks.	167
Where to Get Help.	168
Technical Support Web Site.	168
Contacting Epson Support.	168

About This Manual

Introduction to the Manuals

The following manuals are supplied with your Epson printer. As well as the manuals, check the various types of help information available from the printer itself or from the Epson software applications.

- Important Safety Instructions (paper manual)
Provides you with instructions to ensure the safe use of this printer.
- Start Here (paper manual)
Provides you with information on setting up the printer, installing the software, using the printer, and so on.
- User's Guide (digital manual)
This manual. Provides overall information and instructions on using the printer, on network settings when using the printer on a network, and on solving problems.

You can obtain the latest versions of the above manuals with the following methods.

- Paper manual
Visit the Epson Europe support website at <http://www.epson.eu/Support>, or the Epson worldwide support website at <http://support.epson.net/>.
- Digital manual
Start EPSON Software Updater on your computer. EPSON Software Updater checks for available updates of Epson software applications and the digital manuals, and allows you to download the latest ones.

Related Information

- ➔ [“Application for Updating Software and Firmware \(EPSON Software Updater\)” on page 122](#)

Using the Manual to Search for Information

The PDF manual allows you to search for information you are looking for by keyword, or jump directly to specific sections using the bookmarks. You can also print only the pages you need. This section explains how to use a PDF manual that has been opened in Adobe Reader X on your computer.

About This Manual

Searching by keyword

Click **Edit > Advanced Search**. Enter the keyword (text) for information you want to find in the search window, and then click **Search**. Hits are displayed as a list. Click one of the displayed hits to jump to that page.

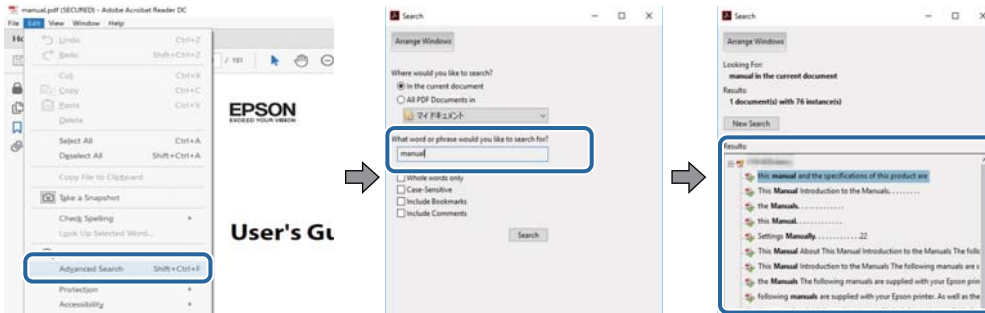

Jumping directly from bookmarks

Click a title to jump to that page. Click + or > to view the lower level titles in that section. To return to the previous page, perform the following operation on your keyboard.

- Windows: Hold down **Alt**, and then press **←**.
- Mac OS: Hold down the command key, and then press **←**.

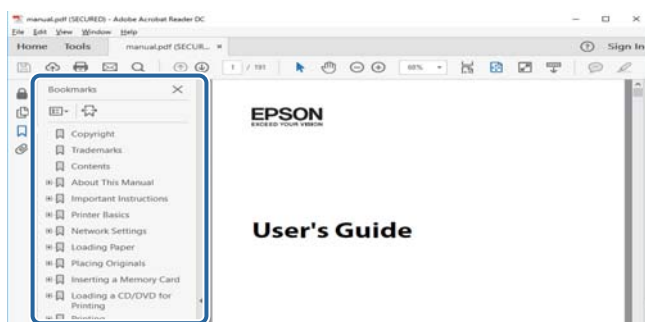

Printing only the pages you need

You can extract and print only the pages you need. Click **Print** in the **File** menu, and then specify the pages you want to print in **Pages in Pages to Print**.

- To specify a series of pages, enter a hyphen between the start page and the end page.
Example: 20-25
- To specify pages that are not in series, divide the pages with commas.
Example: 5, 10, 15

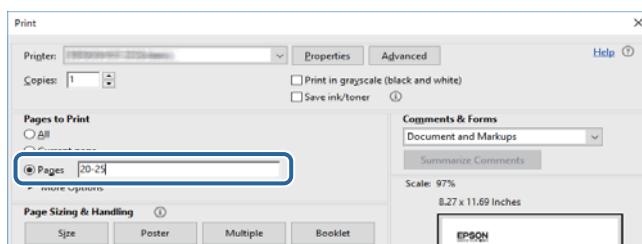

Marks and Symbols

**Caution:**

Instructions that must be followed carefully to avoid bodily injury.

**Important:**

Instructions that must be observed to avoid damage to your equipment.

Note:

Provides complementary and reference information.

➔ Related Information

Links to related sections.

Descriptions Used in this Manual

- Screenshots of the printer driver and the Epson Scan 2 (scanner driver) screens are from Windows 10 or macOS Sierra. The content displayed on the screens varies depending on the model and situation.
- Illustrations of the printer used in this manual are examples only. Although there may be slight differences depending on the model, the method of operation is the same.
- Some of the menu items on the LCD screen vary depending on the model and settings.

Operating System References

Windows

In this manual, terms such as "Windows 10", "Windows 8.1", "Windows 8", "Windows 7", "Windows Vista", "Windows XP", "Windows Server 2016", "Windows Server 2012 R2", "Windows Server 2012", "Windows Server 2008 R2", "Windows Server 2008", "Windows Server 2003 R2", and "Windows Server 2003" refer to the following operating systems. Additionally, "Windows" is used to refer to all versions.

- Microsoft® Windows® 10 operating system
- Microsoft® Windows® 8.1 operating system
- Microsoft® Windows® 8 operating system
- Microsoft® Windows® 7 operating system
- Microsoft® Windows Vista® operating system
- Microsoft® Windows® XP operating system
- Microsoft® Windows® XP Professional x64 Edition operating system
- Microsoft® Windows Server® 2016 operating system
- Microsoft® Windows Server® 2012 R2 operating system
- Microsoft® Windows Server® 2012 operating system

About This Manual

- Microsoft® Windows Server® 2008 R2 operating system
- Microsoft® Windows Server® 2008 operating system
- Microsoft® Windows Server® 2003 R2 operating system
- Microsoft® Windows Server® 2003 operating system

Mac OS

In this manual, "Mac OS" is used to refer to macOS Sierra, OS X El Capitan, OS X Yosemite, OS X Mavericks, OS X Mountain Lion, Mac OS X v10.7.x, and Mac OS X v10.6.8.

Important Instructions

Safety Instructions

Read and follow these instructions to ensure safe use of this printer. Make sure you keep this manual for future reference. Also, be sure to follow all warnings and instructions marked on the printer.

- ❑ Some of the symbols used on your printer are to ensure safety and proper use of the printer. Visit the following Web site to learn the meaning of the symbols.

<http://support.epson.net/symbols>

- ❑ Use only the power cord supplied with the printer and do not use the cord with any other equipment. Use of other cords with this printer or the use of the supplied power cord with other equipment may result in fire or electric shock.
- ❑ Be sure your AC power cord meets the relevant local safety standard.
- ❑ Never disassemble, modify, or attempt to repair the power cord, plug, printer unit, scanner unit, or options by yourself, except as specifically explained in the printer's manuals.
- ❑ Unplug the printer and refer servicing to qualified service personnel under the following conditions:
The power cord or plug is damaged; liquid has entered the printer; the printer has been dropped or the casing damaged; the printer does not operate normally or exhibits a distinct change in performance. Do not adjust controls that are not covered by the operating instructions.
- ❑ Place the printer near a wall outlet where the plug can be easily unplugged.
- ❑ Do not place or store the printer outdoors, near excessive dirt or dust, water, heat sources, or in locations subject to shocks, vibrations, high temperature or humidity.
- ❑ Take care not to spill liquid on the printer and not to handle the printer with wet hands.
- ❑ Keep the printer at least 22 cm away from cardiac pacemakers. Radio waves from this printer may adversely affect the operation of cardiac pacemakers.
- ❑ If the LCD screen is damaged, contact your dealer. If the liquid crystal solution gets on your hands, wash them thoroughly with soap and water. If the liquid crystal solution gets into your eyes, flush them immediately with water. If discomfort or vision problems remain after a thorough flushing, see a doctor immediately.

Safety Instructions for Ink

- ❑ Be careful not to touch any ink when you handle the ink tanks, ink tank caps, and opened ink bottles or ink bottle caps.
 - ❑ If ink gets on your skin, wash the area thoroughly with soap and water.
 - ❑ If ink gets into your eyes, flush them immediately with water. If discomfort or vision problems continue after a thorough flushing, see a doctor immediately.
 - ❑ If ink gets into your mouth, see a doctor right away.
- ❑ Do not shake an ink bottle too vigorously or subject it to strong impacts as this can cause ink to leak.
- ❑ Keep ink bottles and the ink tank unit out of the reach of children. Do not allow children to drink from or handle the ink bottles and ink bottle cap.

Printer Advisories and Warnings

Read and follow these instructions to avoid damaging the printer or your property. Make sure you keep this manual for future reference.



Advisories and Warnings for Setting Up the Printer

- Do not block or cover the vents and openings in the printer.
- Use only the type of power source indicated on the printer's label.
- Avoid using outlets on the same circuit as photocopiers or air control systems that regularly switch on and off.
- Avoid electrical outlets controlled by wall switches or automatic timers.
- Keep the entire computer system away from potential sources of electromagnetic interference, such as loudspeakers or the base units of cordless telephones.
- The power-supply cords should be placed to avoid abrasions, cuts, fraying, crimping, and kinking. Do not place objects on top of the power-supply cords and do not allow the power-supply cords to be stepped on or run over. Be particularly careful to keep all the power-supply cords straight at the ends and the points where they enter and leave the transformer.
- If you use an extension cord with the printer, make sure that the total ampere rating of the devices plugged into the extension cord does not exceed the cord's ampere rating. Also, make sure that the total ampere rating of all devices plugged into the wall outlet does not exceed the wall outlet's ampere rating.
- If you plan to use the printer in Germany, the building installation must be protected by a 10 or 16 amp circuit breaker to provide adequate short-circuit protection and over-current protection for the printer.
- When connecting the printer to a computer or other device with a cable, ensure the correct orientation of the connectors. Each connector has only one correct orientation. Inserting a connector in the wrong orientation may damage both devices connected by the cable.
- Place the printer on a flat, stable surface that extends beyond the base of the printer in all directions. The printer will not operate properly if it is tilted at an angle.
- Allow space above the printer so that you can fully raise the document cover.
- Leave enough space in front of the printer for the paper to be fully ejected.
- Avoid places subject to rapid changes in temperature and humidity. Also, keep the printer away from direct sunlight, strong light, or heat sources.

Advisories and Warnings for Using the Printer

- Do not insert objects through the slots in the printer.
- Do not put your hand inside the printer during printing.
- Do not touch the white flat cable and ink tubes inside the printer.
- Do not use aerosol products that contain flammable gases inside or around the printer. Doing so may cause fire.
- Do not move the print head by hand; otherwise, you may damage the printer.
- Be careful not to trap your fingers when closing the scanner unit.
- Do not press too hard on the scanner glass when placing the originals.

Important Instructions

- ❑ Prolonged use of the printer when the ink level is below the lower line could damage the printer. Fill the ink tank to the upper line while the printer is not operating. To display the correct ink level estimates, reset the ink level after filling the tank.
- ❑ Always turn the printer off using the  button. Do not unplug the printer or turn off the power at the outlet until the  light stops flashing.
- ❑ If you are not going to use the printer for a long period, be sure to unplug the power cord from the electrical outlet.

Advisories and Warnings for Transporting or Storing the Printer

- ❑ When storing or transporting the printer, avoid tilting it, placing it vertically, or turning it upside down; otherwise ink may leak.
- ❑ Before transporting the printer, make sure that the print head is in the home (far right) position.

Advisories and Warnings for Using the Printer with a Wireless Connection

- ❑ Radio waves from this printer may negatively affect the operation of medical electronic equipment, causing them to malfunction. When using this printer inside medical facilities or near medical equipment, follow directions from the authorized personnel representing the medical facilities, and follow all posted warnings and directions on the medical equipment.
- ❑ Radio waves from this printer may negatively affect the operation of automatically controlled devices such as automatic doors or fire alarms, and could lead to accidents due to malfunction. When using this printer near automatically controlled devices, follow all posted warnings and directions on these devices.

Advisories and Warnings for Using Memory Cards

- ❑ Do not remove a memory card or turn off the printer while the memory card light is flashing.
- ❑ The methods for using memory cards vary according to card type. Be sure to refer to the manual packaged with your memory card for details.
- ❑ Use only memory cards compatible with the printer.

Advisories and Warnings for Using the LCD Screen

- ❑ The LCD screen may contain a few small bright or dark spots, and because of its features it may have an uneven brightness. These are normal and do not indicate that it is damaged in any way.
- ❑ Only use a dry, soft cloth for cleaning. Do not use liquid or chemical cleaners.
- ❑ The exterior cover of the LCD screen could break if it receives a heavy impact. Contact your dealer if the screen's surface chips or cracks, and do not touch or attempt to remove the broken pieces.

Important Instructions

Protecting Your Personal Information

When you give the printer to someone else or dispose of it, erase all the personal information stored in the printer's memory by selecting **Settings > Restore Default Settings > All Settings** on the control panel.

Printer Basics

Part Names and Functions

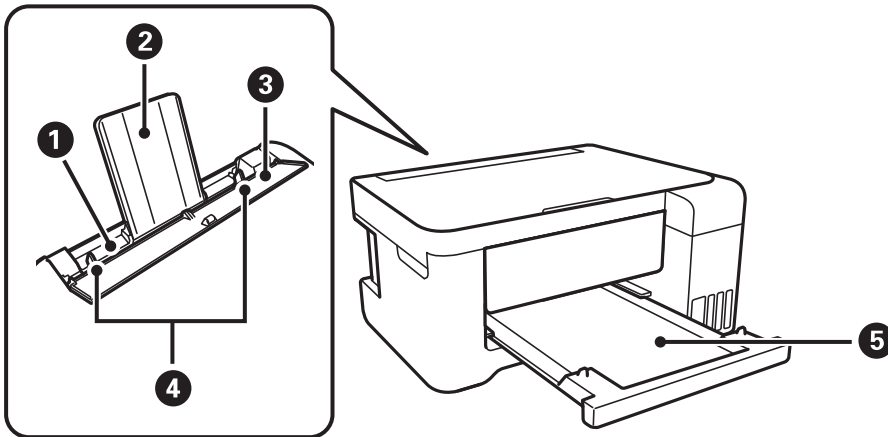

①	Rear paper feed	Loads paper.
②	Paper support	Supports loaded paper.
③	Feeder guard	Prevents foreign substance from entering the printer. Usually keep this guard closed.
④	Edge guides	Feeds the paper straight into the printer. Slide to the edges of the paper.
⑤	Output tray	Holds the ejected paper.

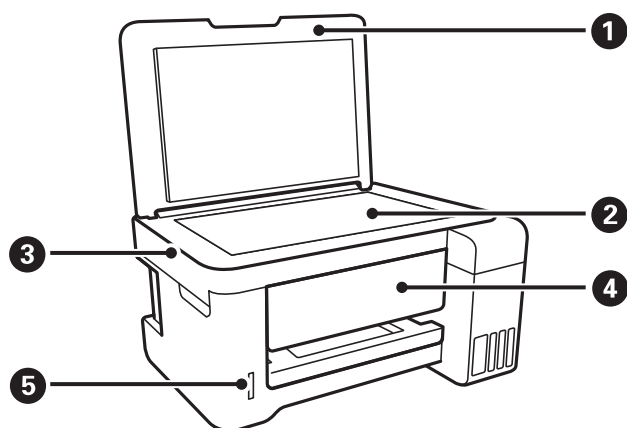

①	Document cover	Blocks external light while scanning.
②	Scanner glass	Place the originals.
③	Scanner unit	Scans placed originals.
④	Control panel	Indicates the printer's status and allows you to make print settings.

Printer Basics

5	Memory card slot	Insert a memory card.
----------	------------------	-----------------------

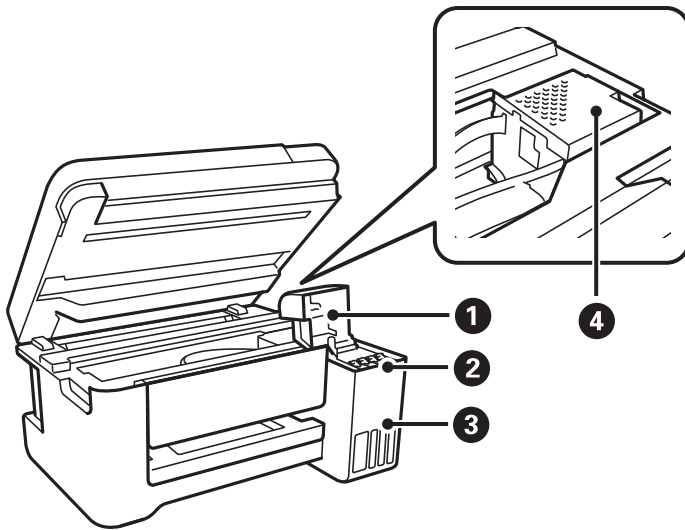

1	Ink tank cover	Open to refill the ink tank.
2	Ink reservoir tank (Ink tank)	Supplies ink to the print head.
3	Ink tank unit	Contains the ink tanks.
4	Print head	Ink is ejected from the print head nozzles underneath.

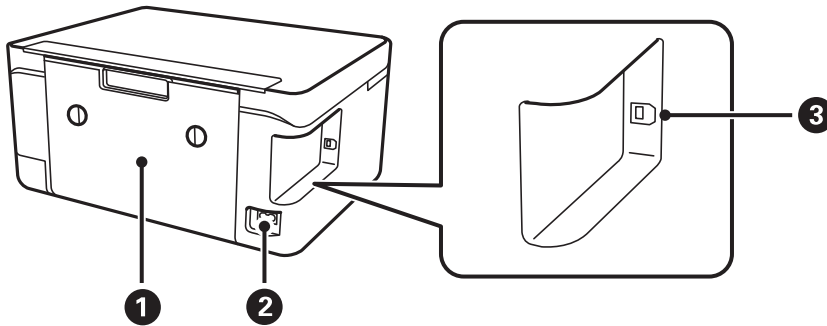

1	Rear cover	Remove when removing jammed paper.
2	AC inlet	Connects the power cord.
3	USB port	Connects a USB cable to connect with a computer.

Printer Basics

Control Panel

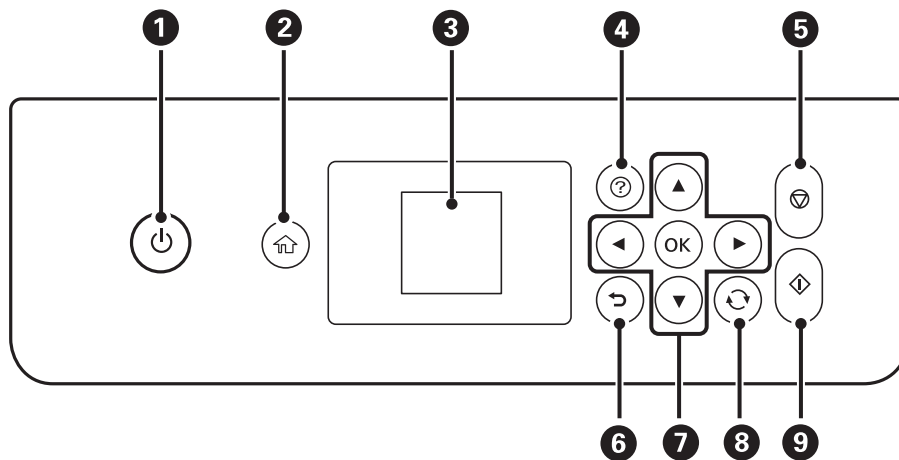

1	Turns the printer on or off. Unplug the power cord after checking that the power light is off.
2	Displays the home screen.
3	Displays menus and messages. Use buttons on the control panel to select a menu or to make settings.
4	Displays the solutions when you are in trouble.
5	Stops the current operation.
6	Returns to the previous screen.
7	Use the ▲▼◀▶ buttons to move the focus to the target, and then press the OK button to open the selected menu or to make settings.
8	Applies to a variety of functions depending on the situation.
9	Starts an operation such as printing or copying.

Guide to the LCD Screen

Menus and messages are displayed on the LCD screen. Select a menu or setting by pressing the ▲▼◀▶ buttons.

Guide to the Home Screen

The following icons and menus are displayed on the home screen.

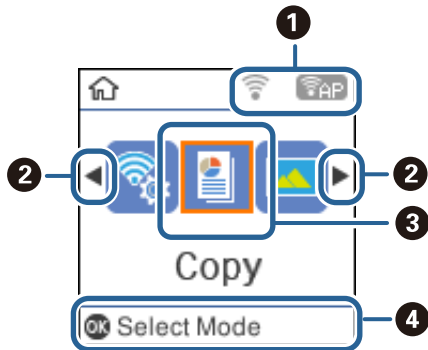

1	Icons that show the network status are displayed.	
		Indicates a problem with the printer's wireless (Wi-Fi) network connection, or that the printer is searching for a wireless (Wi-Fi) network connection.
		Indicates that the printer is connected to a wireless (Wi-Fi) network. The number of bars indicates the signal strength of the connection. The more bars there are, the stronger the connection.
		Indicates that a wireless (Wi-Fi) network is disabled, or that the printer is processing a wireless network connection.
		Indicates that Wi-Fi Direct (Simple AP) is enabled.
		Indicates that Wi-Fi Direct (Simple AP) is disabled.
2	When ◀ and ▶ are displayed, you can scroll right or left by pressing the ◀ or ▶ button.	

Printer Basics

③	Function icons and names are displayed as menu icons.	
	Copy	Enters Copy menu that allows you to copy a document.
	Print Photos	Enters Print Photos menu that allows you to print photos on your memory card.
	Scan	Enters Scan menu that allows you to scan a document or a photo.
	Personal Stationery	Enters Personal Stationery menu that allows you to print original items, such as ruled paper and calendars, using the photos on your memory card.
	Quiet Mode	Displays Quiet Mode setting that allows you to reduce the noise the printer makes. However, enabling this may reduce print speed. Depending on the paper type and print quality settings you selected, there may be no difference in the printer's noise level. This is a shortcut to the following menu. Settings > Printer Setup > Quiet Mode
	Settings	Enters Settings menu that allows you to make maintenance, printer setup, and network settings.
	Maintenance	Access the menus recommended to improve the quality of your printouts. This is a shortcut to the following menu. Settings > Maintenance
Wi-Fi Setup	Displays menus that allow you to set up the printer for use on a wireless network. This is a shortcut to the following menu. Settings > Network Settings > Wi-Fi Setup	
④	Available buttons are displayed. In this example, you can proceed to the selected menu by pressing the OK button.	

Related Information

➔ [“Menu Options for Settings” on page 46](#)

Entering Characters



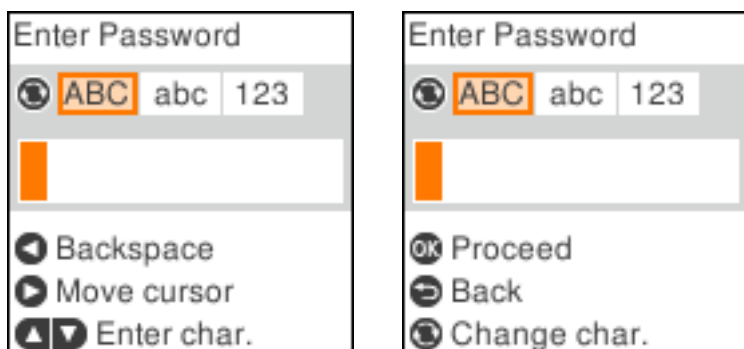

To enter characters and symbols for network settings from the control panel, use the ▲, ▼, ◀, and ▶ buttons.

Press the ▲ or ▼ button to select the character you want to enter, and then press the ▶ button to move the cursor to the next input position. When you have finished entering characters, press the OK button.

The displayed screen varies depending on the setting items. The following is the screen for entering the password for your Wi-Fi network.







Printer Basics

Icons	Descriptions
	Switches the character type. ABC: Uppercase characters abc: Lowercase characters 123: Numbers and symbols
	Selects the character to be entered.
	Moves the cursor to the right.
	Deletes a character to the left (backspace).
OK	Enters the selected characters.
	Returns to the previous screen.

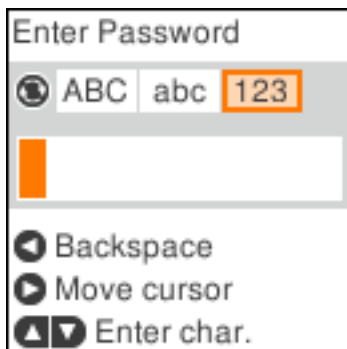
Entering the Practice String "13By"



1. Press the  button twice to switch the character type to **123**.



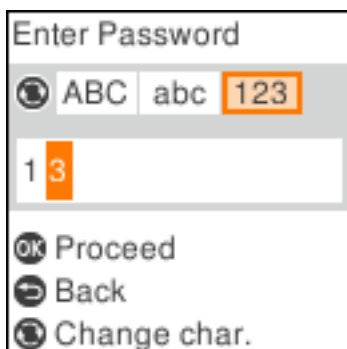



2. Press the  button twice to select "1".
3. Press the  button once to move the cursor, and then press the  button four times to select "3".

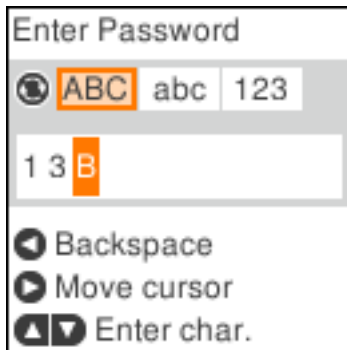

Printer Basics

4. Press the  button once to move the cursor, and then press the  button to switch the character type to **ABC**. Press the  button twice to select "B".



5. Press the  button once to move the cursor, and then press the  button to switch the character type to **abc**. Press the  button twice to select "y".

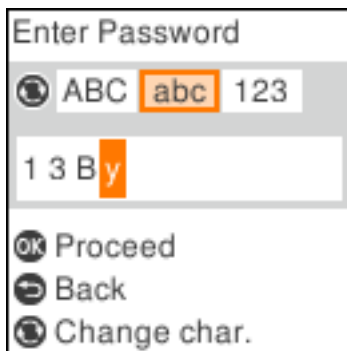

6. Press the OK button.

Network Settings

Network Connection Types

You can use the following connection methods.

Wi-Fi Connection

Connect the printer and the computer or smart device to the access point. This is the typical connection method for home or office networks where computers are connected by Wi-Fi through the access point.

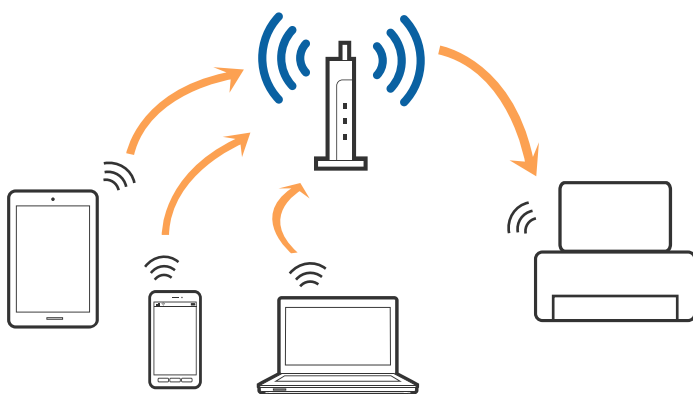

Related Information

- ➔ [“Connecting to a Computer” on page 22](#)
- ➔ [“Connecting to a Smart Device” on page 23](#)
- ➔ [“Making Wi-Fi Settings from the Printer” on page 23](#)

Wi-Fi Direct (Simple AP) Connection

Use this connection method when you are not using Wi-Fi at home or at the office, or when you want to connect the printer and the computer or smart device directly. In this mode, the printer acts as an access point and you can connect up to four devices to the printer without having to use a standard access point. However, devices directly connected to the printer cannot communicate with each other through the printer.

Network Settings

Note:

Wi-Fi Direct (Simple AP) connection is a connection method designed to replace Ad Hoc mode.

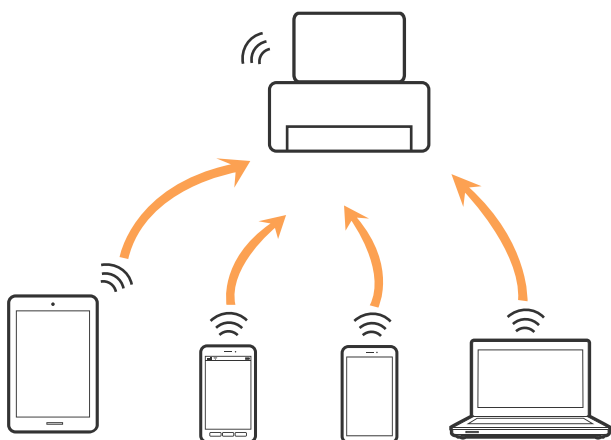

The printer can be connected by Wi-Fi and Wi-Fi Direct (Simple AP) connection simultaneously. However, if you start a network connection in Wi-Fi Direct (Simple AP) connection when the printer is connected by Wi-Fi, the Wi-Fi is temporarily disconnected.

Related Information

➔ [“Making Wi-Fi Direct \(Simple AP\) Connection Settings” on page 26](#)

Connecting to a Computer

We recommend using the installer to connect the printer to a computer. You can run the installer using one of the following methods.

- Setting up from the website

Access the following website, and then enter the product name. Go to **Setup**, and then start setting up.

<http://epson.sn>

- Setting up using the software disc (only for the models that come with a software disc and users with computers with disc drives.)

Insert the software disc into the computer, and then follow the on-screen instructions.

Selecting the Connection Methods

Follow the on-screen instructions until the following screen is displayed, and then select the connection method of the printer to the computer.

Network Settings

Select the connection type and then click **Next**.



Follow the on-screen instructions.

Connecting to a Smart Device

You can use the printer from a smart device when you connect the printer to the same Wi-Fi network (SSID) as the smart device. To use the printer from a smart device, set up from the following website. Access to the website from the smart device that you want to connect to the printer.

<http://epson.sn> > Setup

Note:

If you want to connect a computer and a smart device to the printer at the same time, we recommend connecting the computer first.

Making Wi-Fi Settings from the Printer

You can make network settings from the printer's control panel in several ways. Choose the connection method that matches the environment and conditions that you are using.

If you know the information for the access point such as SSID and password, you can make settings manually.

If the access point supports WPS, you can make settings by using push button setup.

After connecting the printer to the network, connect to the printer from the device that you want to use (computer, smart device, tablet, and so on.)

Related Information

- ➔ “Making Wi-Fi Settings Manually” on page 24
- ➔ “Making Wi-Fi Settings by Push Button Setup” on page 25

Network Settings

- ➔ “Making Wi-Fi Settings by PIN Code Setup (WPS)” on page 26
- ➔ “Making Wi-Fi Direct (Simple AP) Connection Settings” on page 26

Making Wi-Fi Settings Manually

You can manually set up the information necessary to connect to an access point from the printer's control panel. To set up manually, you need the SSID and password for an access point.

Note:

If you are using an access point with its default settings, the SSID and password are on the label. If you do not know the SSID and password, contact the person who set up the access point, or see the documentation provided with the access point.

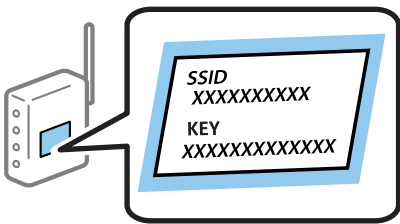

1. Select **Wi-Fi Setup** on the home screen.

To select an item, move the focus to the item using the ▲ ▼ ◀ ▶ buttons, and then press the OK button.

2. Select **Wi-Fi (Recommended)**.
3. Press the OK button.
4. Select **Wi-Fi Setup Wizard**.
5. Select the SSID for the access point from printer's control panel, and then press the OK button.

Note:

- If the SSID you want to connect to is not displayed on the printer's control panel, press the  button to update the list. If it is still not displayed, select **Other SSIDs**, and then enter the SSID directly.
- If you do not know the SSID, check if it is written on the label of the access point. If you are using the access point with its default settings, use the SSID written on the label.

6. Enter the password.

Select whether or not you print a network connection report after finishing the settings.

Note:

- The password is case-sensitive.
- If you do not know the password, check if it is written on the label of the access point. If you are using the access point with its default settings, use the password written on the label. The password may also be called a "Key", a "Passphrase", and so on.
- If you do not know the password for the access point, see the documentation provided with the access point, or contact the person who set it up.
- If you fail to connect, load paper, and then press the  button to print a network connection report.

7. When you have setup finished, and then press the  button.

Related Information

- ➔ [“Entering Characters” on page 18](#)
- ➔ [“Checking the Network Connection Status” on page 27](#)
- ➔ [“When You Cannot Make Network Settings” on page 138](#)

Making Wi-Fi Settings by Push Button Setup

You can automatically set up a Wi-Fi network by pressing a button on the access point. If the following conditions are met, you can set up by using this method.

- The access point is compatible with WPS (Wi-Fi Protected Setup).
- The current Wi-Fi connection was established by pressing a button on the access point.

Note:

If you cannot find the button or you are setting up using the software, see the documentation provided with the access point.

1. Select **Wi-Fi Setup** on the home screen.
To select an item, move the focus to the item using the ▲ ▼ ◀ ▶ buttons, and then press the OK button.
2. Select **Wi-Fi (Recommended)**.
3. Press the OK button.
4. Select **Push Button Setup (WPS)**.
5. Hold down the [WPS] button on the access point until the security light flashes.

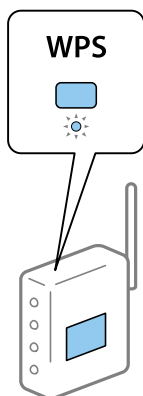

If you do not know where the [WPS] button is, or there are no buttons on the access point, see the documentation provided with your access point for details.

6. Press the OK button on the printer's control panel. Follow the on-screen instruction hereafter.

Note:

If connection fails, restart the access point, move it closer to the printer, and try again. If it still does not work, print a network connection report and check the solution.

Related Information

- ➔ [“Checking the Network Connection Status” on page 27](#)

Network Settings

➔ [“When You Cannot Make Network Settings” on page 138](#)

Making Wi-Fi Settings by PIN Code Setup (WPS)

You can connect to an access point by using a PIN code. You can use this method to set up if an access point is capable of WPS (Wi-Fi Protected Setup). Use a computer to enter a PIN code into the access point.

1. Select **Settings** on the home screen.

To select an item, move the focus to the item using the ▲ ▼ ◀ ▶ buttons, and then press the OK button.

2. Select **Network Settings**.
3. Select **Wi-Fi Setup**.
4. Select **PIN Code (WPS)**.
5. Use your computer to enter the PIN code (an eight digit number) displayed on the printer's control panel into the access point within two minutes.

Note:

See the documentation provided with your access point for details on entering a PIN code.

6. Press the OK button on the printer.

Setup is complete when the setup completion message is displayed.

Note:

If connection fails, restart the access point, move it closer to the printer, and try again. If it still does not work, print a connection report and check the solution.

Related Information

- ➔ [“Checking the Network Connection Status” on page 27](#)
- ➔ [“When You Cannot Make Network Settings” on page 138](#)

Making Wi-Fi Direct (Simple AP) Connection Settings

This method allows you to connect the printer directly to computer or smart devices without an access point. The printer acts as an access point.



Important:

When you connect from a computer or smart device to the printer using the Wi-Fi Direct (Simple AP) connection, the printer is connected to the same Wi-Fi network (SSID) as the computer or smart device and the communication is established between them. Since the computer or smart device is automatically connected to the other connectable Wi-Fi network if the printer is turned off, it is not connected to the previous Wi-Fi network again if the printer is turned on. Connect to the printer's SSID for Wi-Fi Direct (Simple AP) connection from the computer or smart device again. If you do not want to connect every time you turn the printer on or off, we recommend using Wi-Fi network by connecting the printer to an access point.

1. Select **Wi-Fi Setup** on the home screen.

To select an item, move the focus to the item using the ▲ ▼ ◀ ▶ buttons, and then press the OK button.

Network Settings

2. Select **Wi-Fi Direct**.
3. Press the OK button.
4. Press the OK button to start the setup.
5. Press the OK button.
6. Check the SSID and password displayed on the printer's control panel. On the network connection screen of the computer or smart device, select the SSID shown on the printer's control panel to connect.
7. Enter the password displayed on the printer's control panel on the computer or smart device.
8. After the connection is established, press the OK button on the printer's control panel.
9. Press the OK button.

Related Information

- ➔ [“Checking the Network Connection Status” on page 27](#)
- ➔ [“When You Cannot Make Network Settings” on page 138](#)

Checking the Network Connection Status

You can check the network connection status in the following way.

Network Icon

You can check the network connection status and strength of the radio wave using the network icon on the printer's home screen.



Related Information

- ➔ [“Guide to the Home Screen” on page 17](#)

Printing a Network Connection Report

You can print a network connection report to check the status between the printer and the access point.

1. Load papers.

Network Settings

2. Select **Settings** on the home screen, and then press the OK button.

To select an item, move the focus to the item using the ▲ ▼ ◀ ▶ buttons, and then press the OK button.

3. Select **Network Settings > Connection Check**.

The connection check starts.

4. Press the ◇ button to print the network connection report.

If an error has occurred, check the network connection report, and then follow the printed solutions.

Related Information

➔ [“Messages and Solutions on the Network Connection Report” on page 28](#)

Messages and Solutions on the Network Connection Report

Check the messages and error codes on the network connection report, and then follow the solutions.

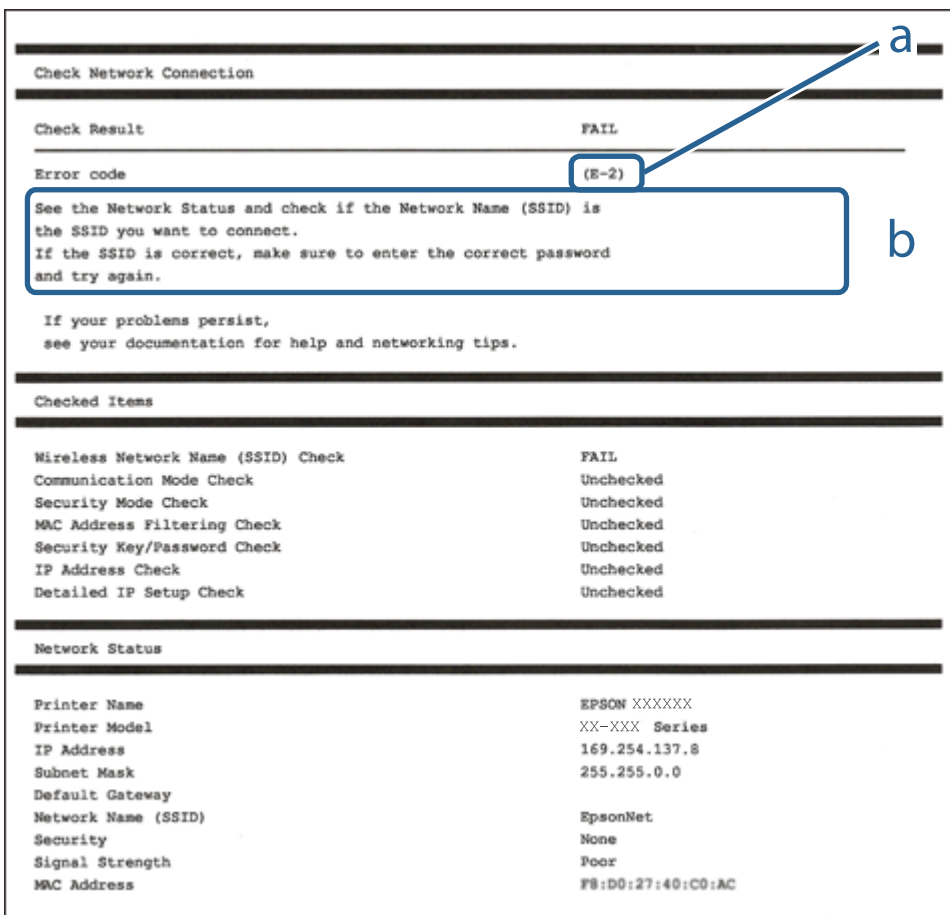

a. Error code

b. Messages on the Network Environment

Network Settings

Related Information

- ➔ [“E-2, E-3, E-7” on page 29](#)
- ➔ [“E-5” on page 30](#)
- ➔ [“E-6” on page 30](#)
- ➔ [“E-8” on page 31](#)
- ➔ [“E-9” on page 31](#)
- ➔ [“E-10” on page 31](#)
- ➔ [“E-11” on page 32](#)
- ➔ [“E-12” on page 32](#)
- ➔ [“E-13” on page 33](#)
- ➔ [“Message on the Network Environment” on page 34](#)

E-2, E-3, E-7

Message:

No wireless network names (SSID) found. Confirm that the router/access point is turned on and the wireless network (SSID) is set up correctly. Contact your network administrator for assistance.

No wireless network names (SSID) found. Confirm that the wireless network name (SSID) of the PC you wish to connect is set up correctly. Contact your network administrator for assistance.

Entered security key/password does not match the one set for your router/access point. Confirm security key/password. Contact your network administrator for assistance.

Solutions:

- Make sure your access point is turned on.
- Confirm that your computer or device is connected correctly to the access point.
- Turn off the access point. Wait for about 10 seconds, and then turn it on.
- Place the printer closer to your access point and remove any obstacles between them.
- If you have entered the SSID manually, check if it is correct. Check the SSID from the **Network Status** part on the network connection report.
- If you are using push button setup to establish a network connection, make sure your access point supports WPS. You cannot use push button setup if your access point does not support WPS.
- Make sure your SSID uses only ASCII characters (alphanumeric characters and symbols). The printer cannot display an SSID that contains non-ASCII characters.
- Make sure you know your SSID and password before connecting to the access point. If you are using an access point with its default settings, the SSID and password are located on a label on the access point. If you do not know your SSID and password, contact the person who set up the access point, or see the documentation provided with the access point.
- If you are connecting to an SSID generated from a tethering smart device, check for the SSID and password in the documentation provided with the smart device.

Network Settings

- If your Wi-Fi connection suddenly disconnects, check for the conditions below. If any of these conditions are applicable, reset your network settings by downloading and running the software from the following website.
<http://epson.sn> > **Setup**
- Another smart device was added to the network using push button setup.
- The Wi-Fi network was set up using any method other than push button setup.

Related Information

- ➔ “Connecting to a Computer” on page 22
- ➔ “Making Wi-Fi Settings from the Printer” on page 23

E-5

Message:

Security mode (e.g. WEP, WPA) does not match the current setting of the printer. Confirm security mode. Contact your network administrator for assistance.

Solutions:

Make sure the access point's security type is set to one of the following. If it is not, change the security type on the access point, and then reset the printer's network settings.

- WEP-64 bit (40 bit)
- WEP-128 bit (104 bit)
- WPA PSK (TKIP/AES)*
- WPA2 PSK (TKIP/AES)*
- WPA (TKIP/AES)
- WPA2 (TKIP/AES)

* WPA PSK is also known as WPA Personal. WPA2 PSK is also known as WPA2 Personal.

E-6

Message:

MAC address of your printer may be filtered. Check whether your router/access point has restrictions such as MAC address filtering. See the documentation of the router/access point or contact your network administrator for assistance.

Solutions:

- Check if MAC address filtering is disabled. If it is enabled, register the printer's MAC address so that it is not filtered. See the documentation provided with the access point for details. You can check the printer's MAC address from the **Network Status** part on the network connection report.
- If your access point is using shared authentication with WEP security, make sure the authentication key and index are correct.

Network Settings

Related Information

➔ [“Printing a Network Status Sheet” on page 34](#)

E-8

Message:

Incorrect IP address is assigned to the printer. Confirm IP address setup of the network device (hub, router, or access point). Contact your network administrator for assistance.

Solutions:

- Enable DHCP on the access point if the printer's Obtain IP Address setting is set to **Auto**.
- If the printer's Obtain IP Address setting is set to Manual, the IP address you manually set is invalid due to out of range (for example: 0.0.0.0). Set a valid IP address from the printer's control panel or by using Web Config.

Related Information

➔ [“Printing a Network Status Sheet” on page 34](#)

E-9

Message:

Confirm the connection and network setup of the PC or other device. Connection using the EpsonNet Setup is available. Contact your network administrator for assistance.

Solutions:

Check the following.

- Devices are turned on.
- You can access the Internet and other computers or network devices on the same network from the devices you want to connect to the printer.

If still does not connect your printer and network devices after confirming the above, turn off the access point. Wait for about 10 seconds, and then turn it on. Then reset your network settings by downloading and running the installer from the following website.

<http://epson.sn> > **Setup**

Related Information

➔ [“Connecting to a Computer” on page 22](#)

E-10

Message:

Confirm IP address, subnet mask, and default gateway setup. Connection using the EpsonNet Setup is available. Contact your network administrator for assistance.

Network Settings

Solutions:

Check the following.

- Other devices on the network are turned on.
- Network addresses (IP address, subnet mask, and default gateway) are correct if you have set the printer's Obtain IP Address to Manual.

Reset the network address if they are incorrect. You can check the IP address, subnet mask, and default gateway from the **Network Status** part on the network connection report.

If DHCP is enabled, change the printer's Obtain IP Address setting to **Auto**. If you want to set the IP address manually, check the printer's IP address from the **Network Status** part on the network connection report, and then select Manual on the network settings screen. Set the subnet mask to [255.255.255.0].

If still does not connect your printer and network devices, turn off the access point. Wait for about 10 seconds, and then turn it on.

Related Information

➔ [“Printing a Network Status Sheet” on page 34](#)

E-11

Message:

Setup is incomplete. Confirm default gateway setup. Connection using the EpsonNet Setup is available. Contact your network administrator for assistance.

Solutions:

Check the following.

- The default gateway address is correct if you set the printer's TCP/IP Setup setting to Manual.
- The device that is set as the default gateway is turned on.

Set the correct default gateway address. You can check the default gateway address from the **Network Status** part on the network connection report.

Related Information

➔ [“Printing a Network Status Sheet” on page 34](#)

E-12

Message:

Confirm the following -Entered security key/password is correct -Index of the security key/password is set to the first number -IP address, subnet mask, or default gateway setup is correct Contact your network administrator for assistance.

Solutions:

Check the following.

Network Settings

- Other devices on the network are turned on.
- The network addresses (IP address, subnet mask, and default gateway) are correct if you are entering them manually.
- The network addresses for other devices (subnet mask and default gateway) are the same.
- The IP address does not conflict with other devices.

If still does not connect your printer and network devices after confirming the above, try the following.

- Turn off the access point. Wait for about 10 seconds, and then turn it on.
- Make network settings again using the installer. You can run it from the following website.
<http://epson.sn> > **Setup**
- You can register several passwords on an access point that uses WEP security type. If several passwords are registered, check if the first registered password is set on the printer.

Related Information

- ➔ “Printing a Network Status Sheet” on page 34
- ➔ “Connecting to a Computer” on page 22

E-13

Message:

Confirm the following -Entered security key/password is correct -Index of the security key/password is set to the first number -Connection and network setup of the PC or other device is correct Contact your network administrator for assistance.

Solutions:

Check the following.

- Network devices such as an access point, hub, and router are turned on.
- The TCP/IP Setup for network devices has not been set up manually. (If the printer's TCP/IP Setup is set automatically while the TCP/IP Setup for other network devices is performed manually, the printer's network may differ from the network for other devices.)

If it still does not work after checking the above, try the following.

- Turn off the access point. Wait for about 10 seconds, and then turn it on.
- Make network settings on the computer that is on the same network as the printer using the installer. You can run it from the following website.
<http://epson.sn> > **Setup**
- You can register several passwords on an access point that uses the WEP security type. If several passwords are registered, check if the first registered password is set on the printer.

Related Information

- ➔ “Printing a Network Status Sheet” on page 34
- ➔ “Connecting to a Computer” on page 22

Network Settings

Message on the Network Environment

Message	Solution
*Multiple network names (SSID) that match your entered network name (SSID) have been detected. Confirm network name (SSID).	The same SSID may be set on several access points. Check the settings on the access points, and change the SSID.
The Wi-Fi environment needs to be improved. Turn the wireless router off and then turn it on. If the connection does not improve, see the documentation for the wireless router.	After moving the printer closer to the access point and removing any obstacles between them, turn off the access point. Wait for about 10 seconds, and then turn it on. If it still does not connect, see the documentation supplied with the access point.
*No more devices can be connected. Disconnect one of the connected devices if you want to add another one.	You can simultaneously connect up to four computers and smart devices in Wi-Fi Direct (Simple AP) connection. To add another computer or smart device, disconnect one of the connected devices first.

Printing a Network Status Sheet

You can check the detailed network information by printing it.

1. Load papers.
2. Select **Settings** on the home screen.

To select an item, move the focus to the item using the ▲ ▼ ◀ ▶ buttons, and then press the OK button.

3. Select **Network Settings** > **Print Status Sheet**.

4. Press the ◊ button.

The network status sheet is printed.

Replacing or Adding New Access Points

If the SSID changes due to the replacement of an access point, or an access point is added and a new network environment is established, re-set the Wi-Fi settings.

Related Information

➔ [“Changing the Connection Method to a Computer” on page 34](#)

Changing the Connection Method to a Computer

Using the installer and re-set up in a different connection method.

Network Settings

- Setting up from the website

Access the following website, and then enter the product name. Go to **Setup**, and then start setting up.

<http://epson.sn>

- Setting up using the software disc (only for the models that come with a software disc and users with computers with disc drives.)

Insert the software disc into the computer, and then follow the on-screen instructions.

Selecting Change the Connection Methods

Follow the on-screen instructions until the following screen is displayed.

Select **Change or re-set the connection method** on the Select Software Installation screen, and then click **Next**.

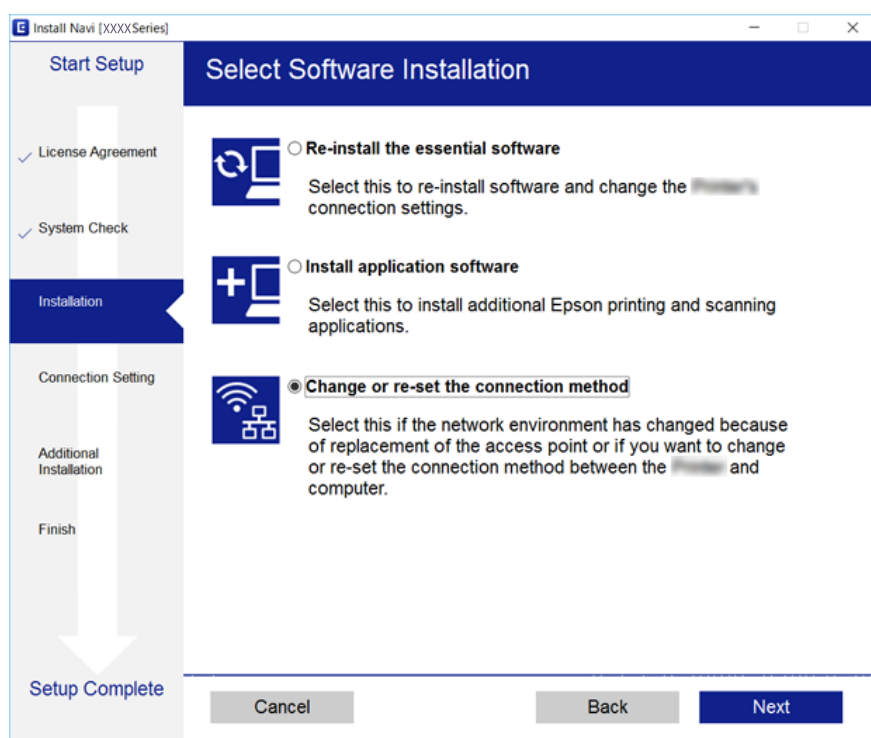

Disabling Wi-Fi from the Control Panel

When Wi-Fi is disabled, the Wi-Fi connection is disconnected.

1. Select **Settings** on the home screen.

To select an item, move the focus to the item using the ▲ ▼ ◀ ▶ buttons, and then press the OK button.

2. Select **Network Settings**.
3. Select **Wi-Fi Setup**.
4. Select **Disable Wi-Fi**.
5. Check the message, and then press the OK button.

Disconnecting Wi-Fi Direct (Simple AP) connection from the Control Panel

Note:

When Wi-Fi Direct (Simple AP) connection disabled, all computers and smart devices connected to the printer in Wi-Fi Direct (Simple AP) connection are disconnected. If you want to disconnect a specific device, disconnect from the device instead of the printer.

1. Select **Settings** on the home screen.

To select an item, move the focus to the item using the ▲ ▼ ◀ ▶ buttons, and then press the OK button.

2. Select **Network Settings**.
3. Select **Wi-Fi Setup**.
4. Select **Wi-Fi Direct Setup**.
5. Select **Disable Wi-Fi Direct**.
6. Check the message, and then press the OK button.

Restoring the Network Settings from the Control Panel

You can restore all network settings to their defaults.

1. Select **Settings** on the home screen.

To select an item, move the focus to the item using the ▲ ▼ ◀ ▶ buttons, and then press the OK button.

2. Select **Restore Default Settings > Network Settings**.
3. Check the message, and then press the OK button.

Preparing the Printer

Loading Papers

Available Paper and Capacities

Epson recommends using genuine Epson paper to ensure high-quality printouts.

Genuine Epson Paper

Media Name	Size	Loading Capacity (Sheets)	2-Sided Printing	Borderless Printing
Epson Bright White Ink Jet Paper	A4	Up to the line indicated by the triangle symbol on the edge guide.	Auto, Manual*1	✓
Epson Ultra Glossy Photo Paper	A4, 13×18 cm (5×7 in.), 10×15 cm (4×6 in.)	20*2	-	✓
Epson Premium Glossy Photo Paper	A4, 13×18 cm (5×7 in.), 16:9 wide size (102×181 mm), 10×15 cm (4×6 in.)	20*2	-	✓
Epson Premium Semigloss Photo Paper	A4, 10×15 cm (4×6 in.)	20*2	-	✓
Epson Photo Paper Glossy	A4, 13×18 cm (5×7 in.), 10×15 cm (4×6 in.)	20*2	-	✓
Epson Matte Paper-Heavyweight	A4	20	-	✓
Epson Double-Sided Matte Paper	A4	1	Manual	✓
Epson Photo Quality Ink Jet Paper	A4	80	-	-

*1 For manual 2-sided printing, you can load up to 30 sheets for paper with one side already printed.

*2 Load one sheet of paper at a time if the paper does not feed correctly or if the printout has uneven colors or smears.

Note:

The availability of paper varies by location. For the latest information on paper available in your area, contact Epson support.

Preparing the Printer

Commercially Available Paper

Media Name	Size	Loading Capacity (Sheets or Envelopes)	2-Sided Printing	Borderless Printing
Plain paper Copy paper Letterhead*4	Letter, A4	Up to the line indicated by the triangle symbol on the edge guide.	Auto, Manual*2	✓*3
	B5, 16K (195×270 mm)	Up to the line indicated by the triangle symbol on the edge guide.	Auto, Manual*2	-
	A5, A6, B6	Up to the line indicated by the triangle symbol on the edge guide.	Manual*2	-
	Legal, Indian-Legal, 8.5×13 in.	1	Manual	-
	User Defined*1 (mm) 54×86 to 182×257 215.9×297 to 1200	1	Manual	-
	User Defined*1 (mm) 182×257 to 215.9×297	1	Auto, Manual	-
Envelope	Envelope #10, Envelope DL, Envelope C6	10	-	-

*1 Only printing from computer or smart device is available.

*2 For manual 2-sided printing, you can load up to 30 sheets for paper with one side already printed.

*3 The borderless printing feature is not available for printing from a memory card.

*4 Paper on which information such as the sender's name or corporation name are pre-printed in the header. There must be a margin of 3 mm or more at the top of the paper. 2-sided printing and borderless printing are not available for letterhead paper.

Paper Handling Precautions

- Read the instruction sheets supplied with the paper.
- Fan and align the edges of the paper before loading. Do not fan or curl photo paper. Doing so may damage the printable side.

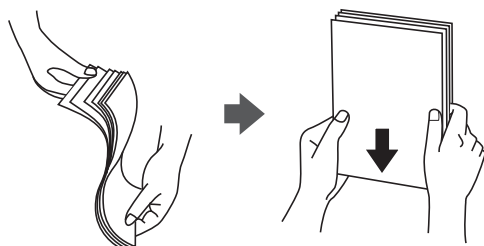

Preparing the Printer

- ❑ If the paper is curled, flatten it or curl it slightly in the opposite direction before loading. Printing on curled paper may cause paper jams and smears on the printout.



- ❑ Do not use paper that is wavy, torn, cut, folded, damp, too thick, too thin, or paper that has stickers stuck to it. Using these types of paper causes paper jams and smears on the printout.
- ❑ Make sure you are using long-grain paper. If you are not sure what type of paper you are using, check the paper packaging or contact the manufacturer to confirm the paper specifications.

Related Information

➔ [“Printer Specifications” on page 156](#)

Loading Paper in the Rear Paper Feed

1. Open the feeder guard and pull out the paper support.

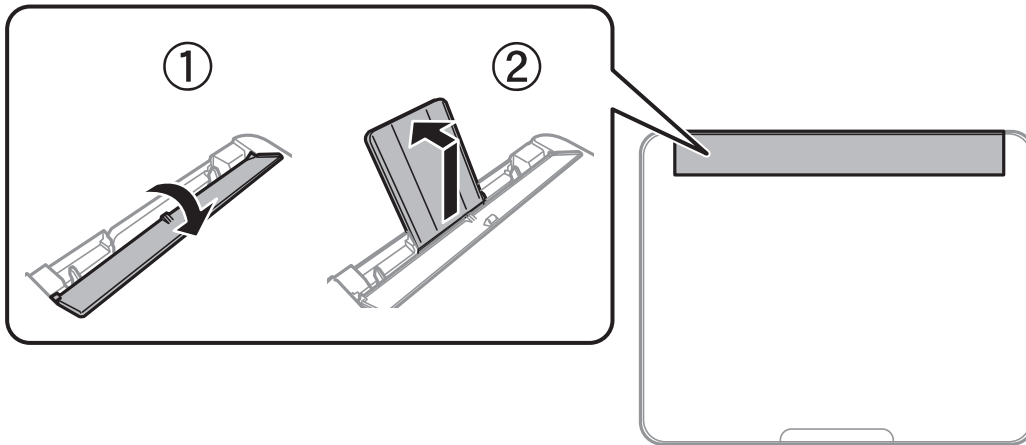

2. Slide the edge guides.

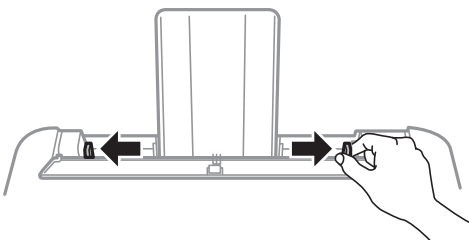

Preparing the Printer

- Load paper at the center of the paper support with the printable side facing up.

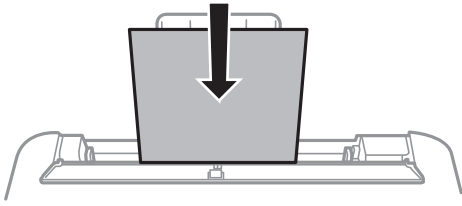

! Important:

- Do not load more than the maximum number of sheets specified for the paper. For plain paper, do not load above the line just under the ▼ symbol inside the edge guide.
- Load paper short edge first. However, when you have set the long edge as the width of the user defined size, load paper long edge first.

- Pre-punched paper

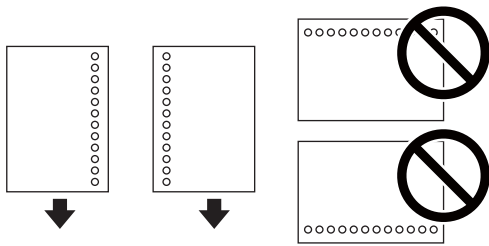

Note:

- Load a single sheet of defined size plain paper with binding holes at the left or right.
- Adjust the print position of your file to avoid printing over the holes.
- Automatic 2-sided printing is not available for pre-punched paper.

- Slide the edge guides to the edges of the paper, and then close the feeder guard.

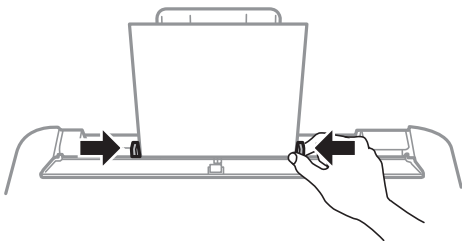

! Important:

Do not place objects on the feeder guard. Doing so may prevent paper from feeding.

- On the control panel, set the size and type of the paper you loaded in the rear paper feed.

To select an item, move the focus to the item using the ▲ ▼ ◀ ▶ buttons, and then press the OK button.

Preparing the Printer

Note:

- ❑ You can also display the paper size and paper type settings screen by selecting **Settings > Printer Setup > Paper Source Settings > Paper Setting**.
- ❑ For letterhead paper, select **Letterhead** as the paper type.
- ❑ For letterhead paper, if you print on paper that is smaller than the setting in the printer driver, the printer may print beyond the edges of the paper which can lead to ink smears on your printouts and excess ink building up inside the printer. Make sure you select the correct paper size setting.
- ❑ 2-sided printing and borderless printing are not available for letterhead paper. Also, the print speed may be slower.

6. Slide out the output tray.

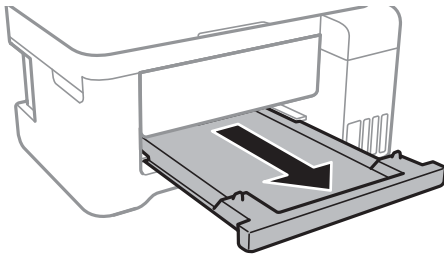
**Note:**

Return the remaining paper to its package. If you leave it in the printer, the paper may curl or the print quality may decline.

Related Information

- ➔ [“Paper Handling Precautions” on page 38](#)
- ➔ [“Available Paper and Capacities” on page 37](#)
- ➔ [“List of Paper Type” on page 42](#)
- ➔ [“Loading Envelopes and Precautions” on page 41](#)
- ➔ [“Loading Long Papers” on page 42](#)

Loading Envelopes and Precautions

Loading envelopes short edge first at the center with the flap facing down, and slide the edge guides to the edges of the envelopes.

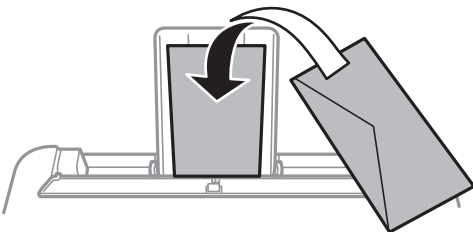

Preparing the Printer

- ❑ Fan and align the edges of the envelopes before loading. When the stacked envelopes are puffed up with air, press them down to flatten them before loading.



- ❑ Do not use envelopes that are curled or folded. Using these envelopes causes paper jams and smears on the printout.
- ❑ Do not use envelopes with adhesive surfaces on the flaps or window envelopes.
- ❑ Avoid using envelopes that are too thin, as they may curl during printing.

Related Information

- ➔ [“Available Paper and Capacities” on page 37](#)
- ➔ [“Loading Paper in the Rear Paper Feed” on page 39](#)

Loading Long Papers

When loading paper longer than legal size, store the paper support and the output tray, and then flatten the leading edge of the paper.

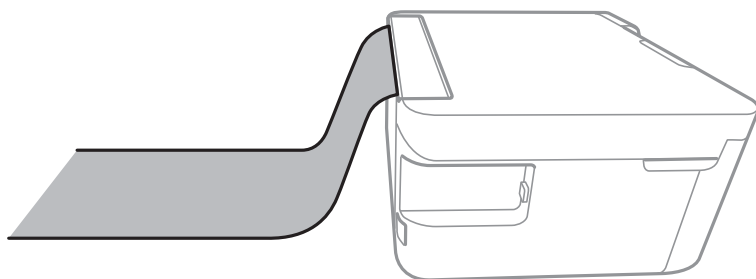

Related Information

- ➔ [“Available Paper and Capacities” on page 37](#)
- ➔ [“Loading Paper in the Rear Paper Feed” on page 39](#)

List of Paper Type

To obtain optimum printing results, select the paper type that suits the paper.

Media Name	Media Type	
	Control Panel	Printer Driver
Epson Bright White Ink Jet Paper	plain papers	Plain paper
Epson Ultra Glossy Photo Paper	Ultra Glossy	Epson Ultra Glossy
Epson Premium Glossy Photo Paper	Prem. Glossy	Epson Premium Glossy

Preparing the Printer

Media Name	Media Type	
	Control Panel	Printer Driver
Epson Premium Semigloss Photo Paper	Prem. Semigloss	Epson Premium Semigloss
Epson Photo Paper Glossy	Glossy	Photo Paper Glossy
Epson Matte Paper-Heavyweight Epson Double-Sided Matte Paper Epson Photo Quality Ink Jet Paper	Matte	Epson Matte

Placing Originals

Placing Originals on the Scanner Glass

! *Important:*

When placing bulky originals such as books, prevent exterior light from shining directly onto the scanner glass.

1. Open the document cover.

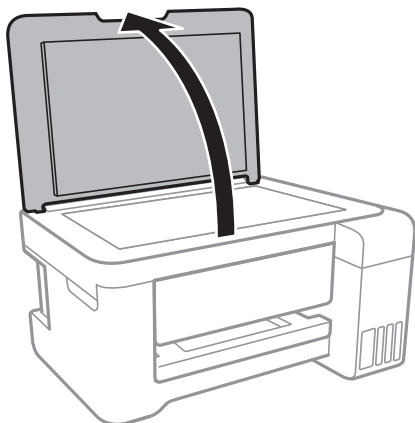

2. Remove any dust or stains on the scanner glass.
3. Place the original face-down and slide it to the corner mark.

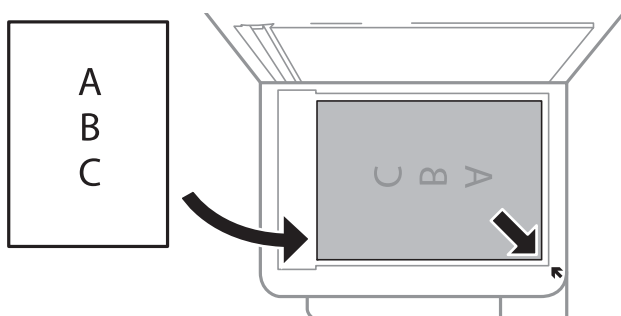

Preparing the Printer

Note:

A range of 1.5 mm from the bottom edge and right edge of the scanner glass is not scanned.

- Close the cover gently.



Important:

Do not apply too much force to the scanner glass or the document cover. Otherwise, they may be damaged.

- Remove the originals after scanning.

Note:

If you leave the originals on the scanner glass for a long time, they may stick to the surface of the glass.

Placing an ID Card for Copying

Place an ID card 5 mm away from the corner mark of the scanner glass.

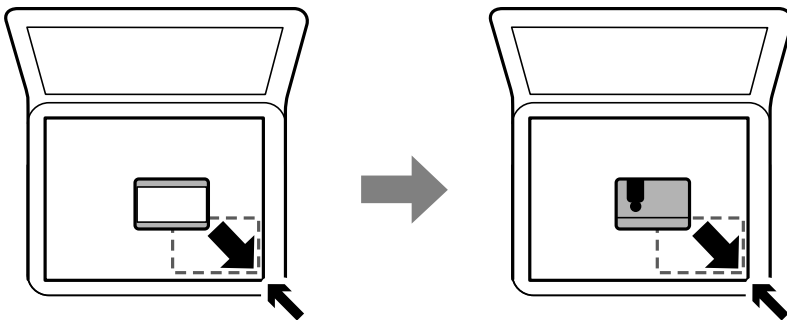

Inserting a Memory Card

Supported Memory Cards

	<p>miniSD*</p> <p>miniSDHC*</p> <p>microSD*</p> <p>microSDHC*</p> <p>microSDXC*</p>
	<p>SD</p> <p>SDHC</p> <p>SDXC</p>

* Attach an adapter to fit the memory card slot. Otherwise, the card may get stuck.

Preparing the Printer

Inserting and Removing a Memory Card

1. Insert a memory card into the printer.

The printer starts reading the data and the light flashes. When reading is complete, the light stops flashing and remains on.

**Important:**

Insert a memory card straight into the printer.

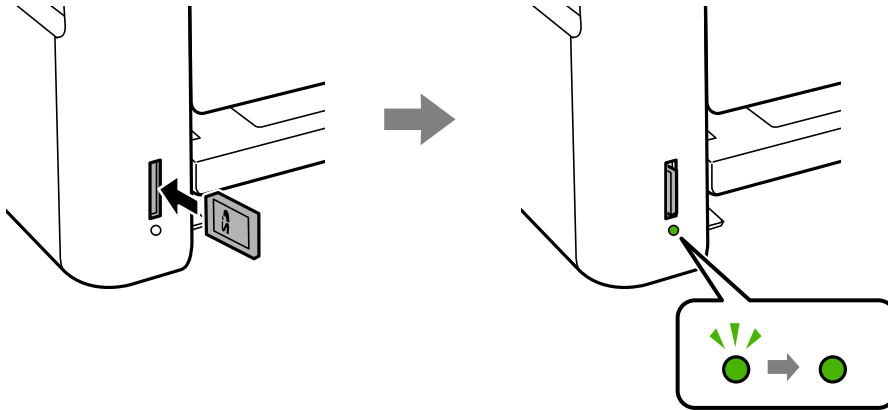

2. When you have finished using the memory card, make sure the light is not flashing, and then push the card to remove it.

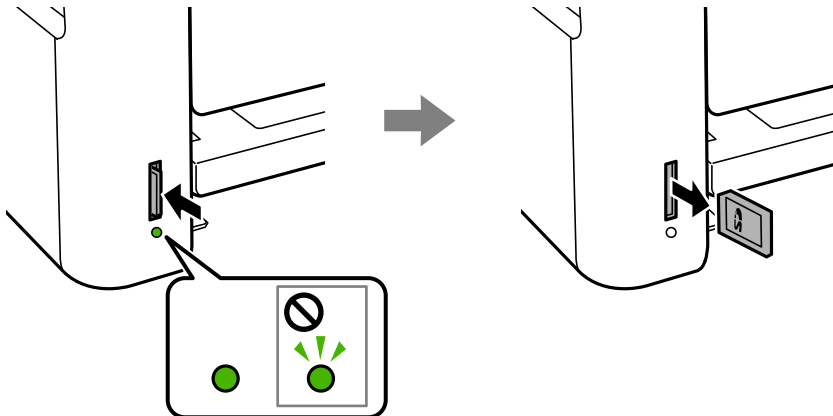
**Important:**

If you remove the memory card while the light is flashing, the data in the memory card may be lost.

Note:

If you access the memory card from a computer, you need to operate the computer to safely remove the removable device.

Related Information

- ➔ [“External Storage Device Specifications” on page 159](#)
- ➔ [“Accessing a Memory Card From a Computer” on page 46](#)

Preparing the Printer

Accessing a Memory Card From a Computer

You can write or read data on an external storage device such as a memory card that has been inserted in the printer from a computer.



Important:

- ❑ Insert a memory card after removing write protection.
- ❑ If an image is saved to the memory card from a computer, the image and the number of photos are not refreshed on the LCD screen. Remove and insert the memory card again.
- ❑ When sharing an external device inserted in the printer between computers connected over USB and over a network, write access is only allowed to the computers that are connected by the method you selected on the printer. To write to the external storage device, enter **Settings** on the control panel and select **File Sharing** and a connection method.

Note:

It takes a while to recognize data from a computer if a large external storage device, such as 2TB HDD, is connected.

Windows

Select an external storage device in **Computer** or **My Computer**. The data on the external storage device is displayed.

Note:

If you connected the printer to the network without the software disc or Web Installer, map a memory card slot or USB port as a network drive. Open **Run** and enter a printer name \\XXXXX or a printer's IP address \\XXX.XXX.XXX.XXX to **Open**. Right-click a device icon displayed to assign the network. The network drive appears in **Computer** or **My Computer**.

Mac OS

Select a corresponding device icon. The data on the external storage device is displayed.

Note:

- ❑ To remove an external storage device, drag and drop the device icon to the trash icon. Otherwise, data in the shared drive may not be displayed correctly when another external storage device is inserted.
- ❑ To access an external storage device through the network, select **Go > Connect to Server** from the menu on the desktop. Enter a printer name `cifs://XXXXX` or `smb://XXXXX` (Where "XXXXX" is the printer name) in the **Server Address**, and then click **Connect**.

Related Information

- ➔ [“Advisories and Warnings for Using Memory Cards” on page 12](#)
- ➔ [“Inserting a Memory Card” on page 44](#)
- ➔ [“External Storage Device Specifications” on page 159](#)

Menu Options for Settings

Select **Settings** on the home screen of the printer to make various settings.

Preparing the Printer

Menu Options for Maintenance

Select the menus on the control panel as described below.

Settings > Maintenance

Nozzle Check:

Select this feature to check if the print head nozzles are clogged. The printer prints a nozzle check pattern.

Head Cleaning:

Select this feature to clean clogged nozzles in the print head.

Power Cleaning:

Select this feature to replace all of the ink inside the ink tubes. More ink is consumed than in usual cleaning. See the "Related Information" below for details on using this feature.

Print Head Alignment:

Select this feature to adjust the print head to improve print quality.

Vertical Alignment

Select this feature if your printouts look blurry or text and lines are misaligned.

Horizontal Alignment

Select this feature if horizontal banding appears at regular intervals in your printouts.

Reset Ink Levels:

Select this feature to reset the ink levels to 100% when refilling the ink tank.

Paper Guide Cleaning:

Select this feature if there are ink stains on the internal rollers. The printer feeds paper to clean the internal rollers.

Related Information

- ➔ ["Checking and Cleaning the Print Head" on page 107](#)
- ➔ ["Running Power Cleaning" on page 108](#)
- ➔ ["Aligning the Print Head" on page 110](#)
- ➔ ["Refilling the Ink Tanks" on page 102](#)
- ➔ ["Cleaning the Paper Path for Ink Smears" on page 111](#)

Menu Options for Printer Setup

Select the menus on the control panel as described below.

Settings > Printer Setup

Preparing the Printer

Paper Source Settings:

Paper Setting:

Select the paper size and paper type you loaded in the paper sources.

A4/Letter Auto Switching:

Select **On** to feed paper from the paper source set as A4 size when there is no paper source set as Letter, or feed from the paper source set as Letter size when there is no paper source set as A4.

Error Notice:

Select **On** to display an error message when the selected paper size or type does not match the loaded paper.

Paper Setup Auto Display:

Select **On** to display the **Paper Setting** screen when loading paper in the paper source. If you disable this feature, you cannot print from an iPhone or iPad using AirPrint.

Quiet Mode:

Your product may not have this feature depending on the location of purchase.

Select **On** to reduce noise during printing, however, this may lower the print speed. Depending on the paper type and print quality settings you selected, there may be no difference in the printer's noise level.

Power Off Timer:

Your product may have this feature or the Power Off Settings feature depending on the location of purchase.

Select this setting to turn the printer off automatically when it is not used for a specified period of time. You can adjust the time before power management is applied. Any increase will affect the product's energy efficiency. Please consider the environment before making any change.

Power Off Settings:

Your product may have this feature or the **Power Off Timer** feature depending on the location of purchase.

Power Off If Inactive

Select this setting to turn the printer off automatically if it is not used for a specified period of time. Any increase will affect the product's energy efficiency. Please consider the environment before making any change.

Power Off If Disconnected

Select this setting to turn the printer off after a specified period of time when all ports including the USB port are disconnected. This feature may not be available depending on your region.

See the following website for the specified period of time.

<https://www.epson.eu/energy-consumption>

Language:

Select the language used on the LCD screen.

Preparing the Printer

Sleep Timer:

Adjust the time period to enter a sleep mode (energy saving mode) when the printer has not performed any operations. The LCD screen turns black when the setting time passes.

Auto Error Solver:

Select an action to perform when a 2-sided printing error or a memory full error occurs.

On

Displays a warning and prints in single-sided mode when a 2-sided printing error occurs, or prints only what the printer could process when a memory full error occurs.

Off

Displays an error message and cancels printing.

Ink Drying Time:

Select the ink drying time you want to use when performing 2-sided printing. The printer prints the other side after printing one side. If your printout is smeared, increase the time setting.

Bidirectional:

Select **On** to change the print direction; Prints while the print head moves to the left and to the right. If vertical or horizontal ruled lines on your printout look blurred or misaligned, disabling this feature may solve the problem; however, doing so may reduce print speed.

Related Information

➔ [“Saving Power - Control Panel” on page 53](#)

Menu Options for Network Settings

Select the menus on the control panel as described below.

Settings > Network Settings

Print Status Sheet

Prints a network status sheet.

Wi-Fi Setup

Wi-Fi Setup Wizard

Select a SSID, enter a password, and then connect the printer to a wireless (Wi-Fi) network.

Push Button (WPS)

Connects the printer to a wireless (Wi-Fi) network by pressing a WPS push button on a wireless router.

PIN Code (WPS)

In the wireless router utility, enter the PIN code displayed on the printer's screen to connect the printer to a wireless (Wi-Fi) network.

Preparing the Printer

Wi-Fi Auto Connect

Connects the printer to a wireless (Wi-Fi) network using a computer that is connected to the access point. If a software disc is supplied with the printer, insert it into the computer, and then follow the on-screen instructions. When you are prompted to operate the printer, access this menu. You can also set up from the website. Access the following website, and then enter the product name. Go to **Setup**, and then start setting up.

<http://epson.sn>

Disable Wi-Fi

Disables the connection by turning off the wireless signal without deleting the network information. To enable the connection, set up the wireless (Wi-Fi) network again.

Wi-Fi Direct Setup

Connects the printer to a wireless (Wi-Fi) network without a wireless router.

Connection Check

Checks the status of the network connection and prints the network connection report. If there are any problems with the connection, see the check report to solve the problem.

Related Information

- ➔ [“Checking the Network Connection Status” on page 27](#)
- ➔ [“Making Wi-Fi Settings Manually” on page 24](#)
- ➔ [“Making Wi-Fi Settings by Push Button Setup” on page 25](#)
- ➔ [“Making Wi-Fi Settings by PIN Code Setup \(WPS\)” on page 26](#)
- ➔ [“Disconnecting Wi-Fi Direct \(Simple AP\) connection from the Control Panel” on page 36](#)

Menu Options for Epson Connect Services

Select the menus on the control panel as described below.

Settings > Epson Connect Services

Register/Delete:

Register or delete the printer to or from the Epson Connect services.

For usage guides, see the following portal website.

<https://www.epsonconnect.com/>

<http://www.epsonconnect.eu> (Europe only)

Suspend/Resume:

Select whether to suspend or resume Epson Connect services.

Email Address:

Check the printer's email address that is registered to the Epson Connect services.

Status:

Check whether or not the printer is registered and connected to the Epson Connect services.

Preparing the Printer

Related Information

➔ [“Printing Using a Network Service” on page 126](#)

Menu Options for Google Cloud Print Services

Select the menus on the control panel as described below.

Settings > Google Cloud Print Services

Suspend/Resume

Select whether to suspend or resume the Google Cloud Print services.

Unregister

Unregister the Google Cloud Print services.

Status

Check whether or not the printer is registered and connected to the Google Cloud Print services.

For registration and usage guides, see the following portal website.

<https://www.epsonconnect.com/>

<http://www.epsonconnect.eu> (Europe only)

Related Information

➔ [“Printing Using a Network Service” on page 126](#)

Menu Options for File Sharing

Select the menus on the control panel as described below.

Settings > File Sharing

Select the connection method between the printer and a computer that will have write access to the memory card inserted in the printer. Read and write access is given to the computer with the priority connection. Only read access is given to other computers.

Menu Options for Print Status Sheet

Select the menus on the control panel as described below.

Settings > Print Status Sheet

Configuration Status Sheet:

Print information sheets showing the current printer status and settings.

Supply Status Sheet:

Print information sheets showing the status of consumables.

Preparing the Printer

Usage History Sheet:

Print information sheets showing the usage history of the printer.

Menu Options for Print Counter

Select the menus on the control panel as described below.

Settings > Print Counter

Displays the total number of prints, B&W prints, and color prints from the time you purchased the printer.

Menu Options for Firmware Update

Select the menus on the control panel as described below.

Settings > Firmware Update

Update:

Checks if the latest version of the firmware has been uploaded to the network server. If an update is available, you can select whether or not to start updating.

Current Version:

Displays the current firmware version of your printer.

Notification:

Checks for firmware updates periodically and notifies you if an update is available.

Menu Options for Restore Default Settings

Select the menus on the control panel as described below.

Settings > Restore Default Settings

Network Settings:

Resets the network settings to their defaults.

All except Network:

Resets all settings except for network settings to their defaults.

All Settings:

Resets all settings to their defaults.

Saving Power

The printer enters sleep mode or turns off automatically if no operations are performed for a set period. You can adjust the time before power management is applied. Any increase will affect the product's energy efficiency. Please consider the environment before making any change.

Saving Power - Control Panel

1. Select **Settings** on the home screen.

To select an item, move the focus to the item using the ▲ ▼ ◀ ▶ buttons, and then press the OK button.

2. Select **Printer Setup**.

3. Do one of the following.

- Select **Sleep Timer** or **Power Off Settings** > **Power Off If Inactive** or **Power Off If Disconnected**, and then make settings.
- Select **Sleep Timer** or **Power Off Timer**, and then make settings.

Note:

*Your product may have the **Power Off Settings** or **Power Off Timer** feature depending on the location of purchase.*

Printing

Printing from the Printer Driver on Windows

Accessing the Printer Driver

When accessing the printer driver from the computer's control panel, the settings are applied to all of the applications.

Accessing the printer driver from the control panel

Windows 10/Windows Server 2016

Right-click the start button or press and hold it, and then select **Control Panel > View devices and printers in Hardware and Sound**. Right-click on your printer, or press and hold it and then select **Printing preferences**.

Windows 8.1/Windows 8/Windows Server 2012 R2/Windows Server 2012

Select **Desktop > Settings > Control Panel > View devices and printers in Hardware and Sound**. Right-click on your printer, or press and hold it and then select **Printing preferences**.

Windows 7/Windows Server 2008 R2

Click the start button, and select **Control Panel > View devices and printers in Hardware and Sound**. Right-click on your printer and select **Printing preferences**.

Windows Vista/Windows Server 2008

Click the start button, and select **Control Panel > Printers in Hardware and Sound**. Right-click on your printer and select **Select printing preferences**.

Windows XP/Windows Server 2003 R2/Windows Server 2003

Click the start button, and select **Control Panel > Printers and Other Hardware > Printers and Faxes**. Right-click on your printer and select **Printing preferences**.

Accessing the printer driver from the printer icon on the task bar

The printer icon on the desktop task bar is a shortcut icon allowing you to quickly access the printer driver.

If you click the printer icon and select **Printer Settings**, you can access the same printer settings window as the one displayed from the control panel. If you double-click this icon, you can check the status of the printer.

Note:

*If the printer icon is not displayed on the task bar, access the printer driver window, click **Monitoring Preferences** on the **Maintenance** tab, and then select **Register the shortcut icon to the taskbar**.*

Printing Basics

Note:

Operations may differ depending on the application. See the application's help for details.

1. Open the file you want to print.

Load paper in the printer if it has not already been loaded.

Printing

2. Select **Print** or **Page Setup** from the **File** menu.
3. Select your printer.
4. Select **Preferences** or **Properties** to access the printer driver window.

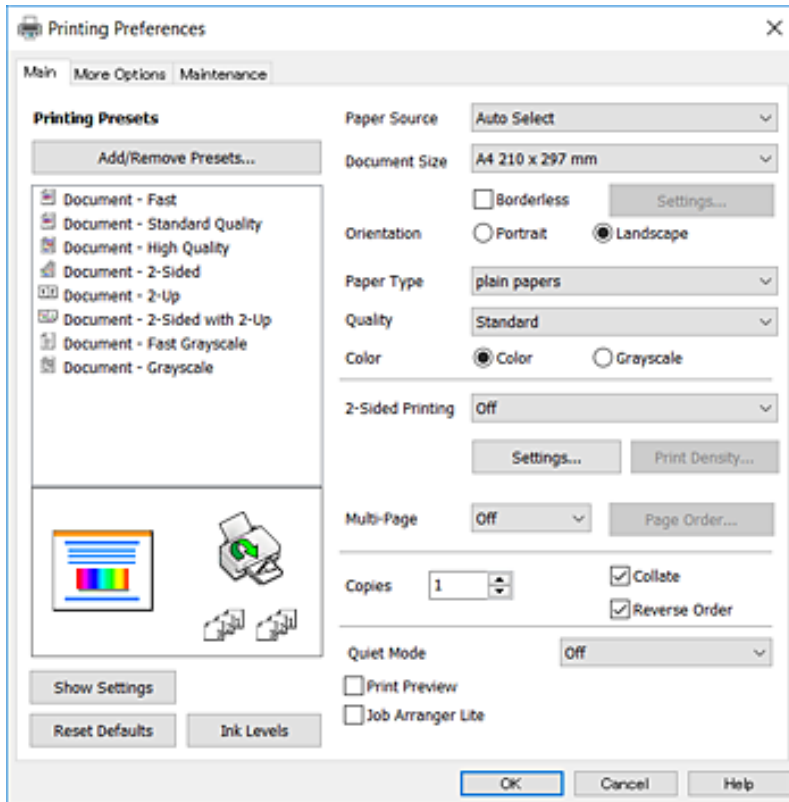

5. Change the settings as necessary.
See the menu options for the printer driver for details.

Note:

- You can also see the online help for explanations of the setting items. Right-clicking an item displays **Help**.
- When you select **Print Preview**, you can see a preview of your document before printing.

6. Click **OK** to close the printer driver window.
7. Click **Print**.

Note:

When you select **Print Preview**, a preview window is displayed. To change the settings, click **Cancel**, and then repeat the procedure from step 2.

Related Information

- ➔ [“Available Paper and Capacities” on page 37](#)
- ➔ [“Loading Paper in the Rear Paper Feed” on page 39](#)
- ➔ [“List of Paper Type” on page 42](#)
- ➔ [“Main Tab” on page 70](#)

Printing on 2-Sides

You can print on both sides of the paper. You can also print a booklet that can be created by re-ordering the pages and folding the printout.

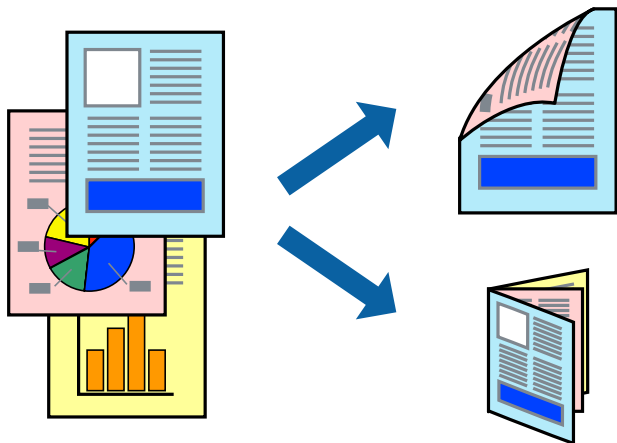

Note:

- This feature is not available for borderless printing.
- You can use automatic and manual 2-sided printing. During manual 2-sided printing, flip the paper over to print on the other side when the printer has finished printing the first side.
- If you do not use paper that is suitable for 2-sided printing, the print quality may decline and paper jams may occur.
- Depending on the paper and the data, ink may bleed through to the other side of the paper.

Related Information

➔ [“Available Paper and Capacities” on page 37](#)

Print Settings

Manual 2-sided printing is available when EPSON Status Monitor 3 is enabled. However, it may not be available when the printer is accessed over a network or is used as a shared printer.

Note:

To enable EPSON Status Monitor 3, click **Extended Settings** on the **Maintenance** tab, and then select **Enable EPSON Status Monitor 3**.

1. On the printer driver's **Main** tab, select an option from **2-Sided Printing**.
2. Click **Settings**, make the appropriate settings, and then click **OK**.

Make settings for **Print Density** if necessary. This setting is not available when you select manual 2-sided printing.

Note:

- To print a folded booklet, select **Booklet**.
- When setting **Print Density**, you can adjust print density according to the document type.
- Printing may be slow depending on the combination of options selected for **Select Document Type** in the **Print Density Adjustment** window and for **Quality** on the **Main** tab.

Printing

3. Click **Print**.

For manual 2-sided printing, when the first side has finished printing, a pop-up window is displayed on the computer. Follow the on-screen instructions.

Related Information

- ➔ “Printing Basics” on page 54
- ➔ “Main Tab” on page 70

Printing Several Pages on One Sheet

You can print two or four pages of data on a single sheet of paper.

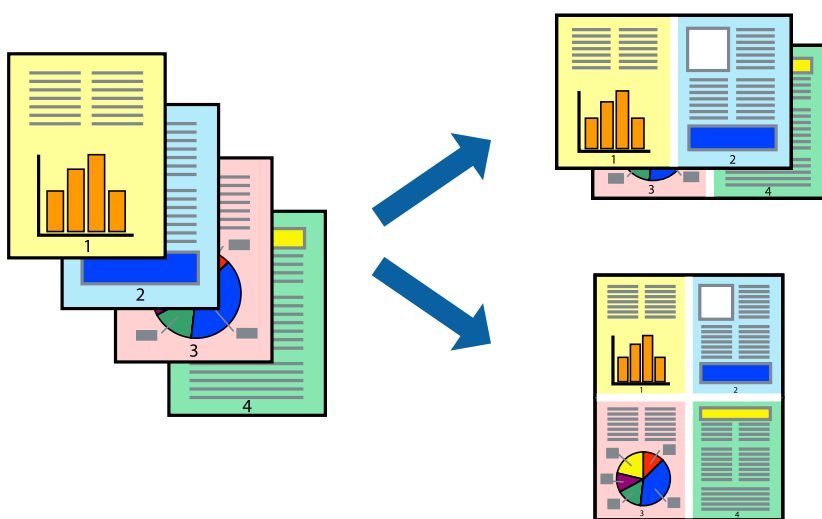

Print Settings

On the printer driver's **Main** tab, select **2-Up** or **4-Up** as the **Multi-Page** setting.

Note:

This feature is not available for borderless printing.

Related Information

- ➔ “Printing Basics” on page 54
- ➔ “Main Tab” on page 70

Printing and Stacking in Page Order (Reverse Order Printing)

You can print from the last page so that the documents are stacked in page order.

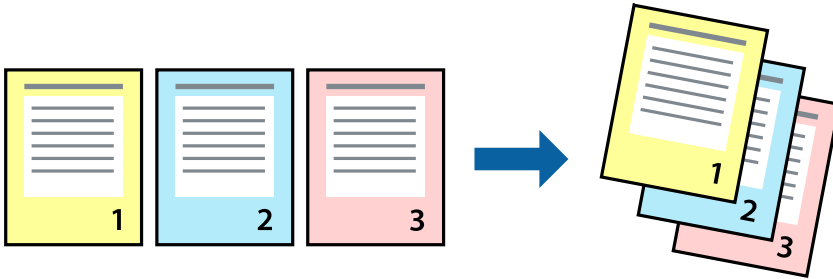

Print Settings

On the printer driver's **Main** tab, select **Reverse Order**.

Related Information

- ➔ [“Printing Basics” on page 54](#)
- ➔ [“Main Tab” on page 70](#)

Printing a Reduced or Enlarged Document

You can reduce or enlarge the size of a document by a specific percentage or to fit the paper size you loaded in the printer.



Print Settings

On the printer driver's **More Options** tab, select the document size from the **Document Size** setting. Select the paper size you want to print on from the **Output Paper** setting. Select **Reduce/Enlarge Document**, and then select **Fit to Page** or **Zoom to**. When you select **Zoom to**, enter a percentage.

Select **Center** to print the images in the center of the page.

Printing

Note:

This feature is not available for borderless printing.

Related Information

- ➔ “Printing Basics” on page 54
- ➔ “More Options Tab” on page 71

Printing One Image on Multiple Sheets for Enlargement (Creating a Poster)

This feature allows you to print one image on multiple sheets of paper. You can create a larger poster by taping them together.

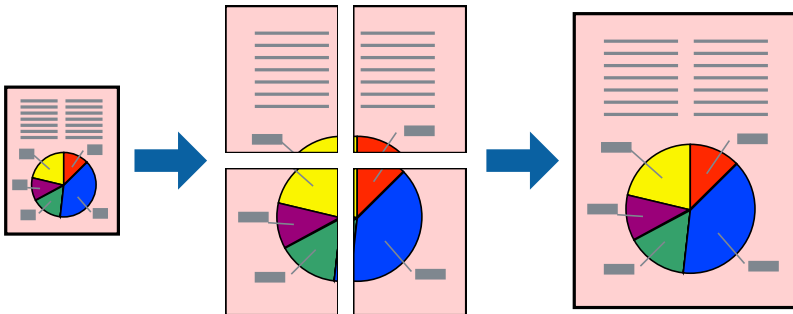
**Note:**

This feature is not available for borderless printing.

Print Settings

On the printer driver's **Main** tab, select **2x1 Poster**, **2x2 Poster**, **3x3 Poster**, or **4x4 Poster** as the **Multi-Page** setting. If you click **Settings**, you can select the panels that you do not want to print. You can also select the cutting guide options.

Related Information

- ➔ “Printing Basics” on page 54
- ➔ “Main Tab” on page 70

Making Posters Using Overlapping Alignment Marks

Here is an example of how to make a poster when **2x2 Poster** is selected, and **Overlapping Alignment Marks** is selected in **Print Cutting Guides**.

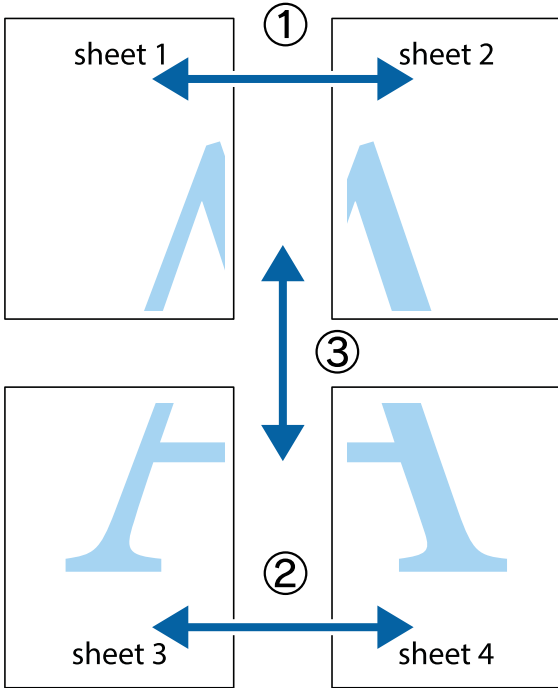

1. Prepare Sheet 1 and Sheet 2. Cut off the margins of Sheet 1 along the vertical blue line through the center of the top and bottom cross marks.

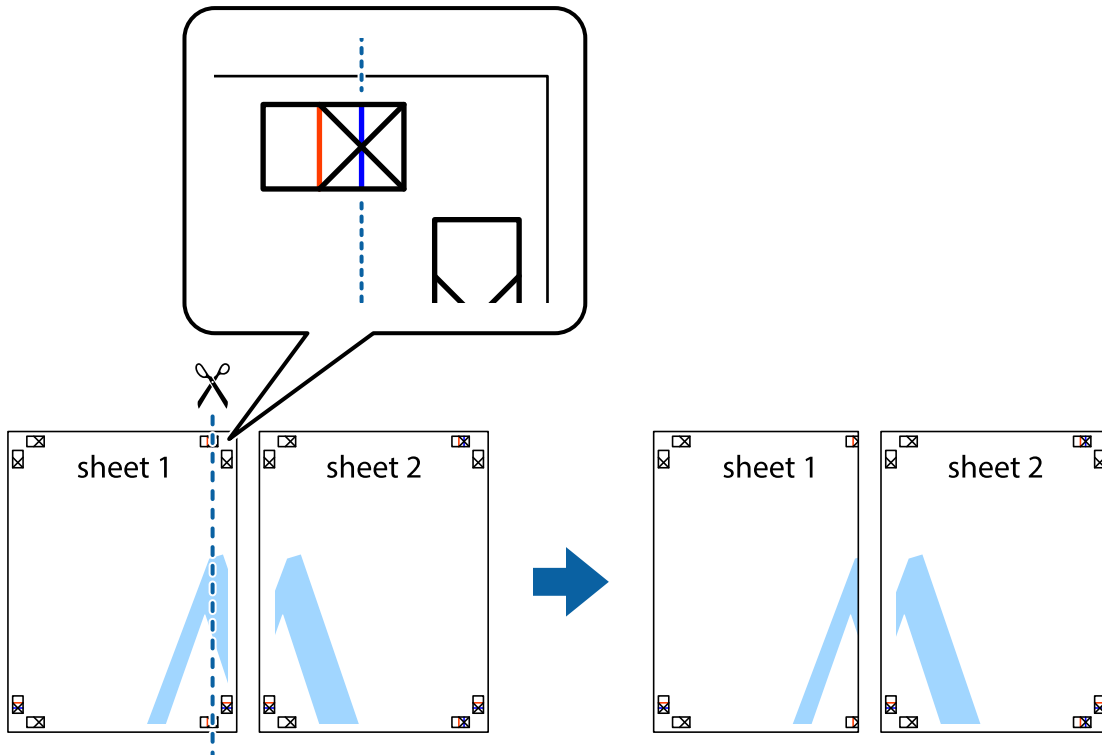

Printing

2. Place the edge of Sheet 1 on top of Sheet 2 and align the cross marks, then temporarily tape the two sheets together from the back.

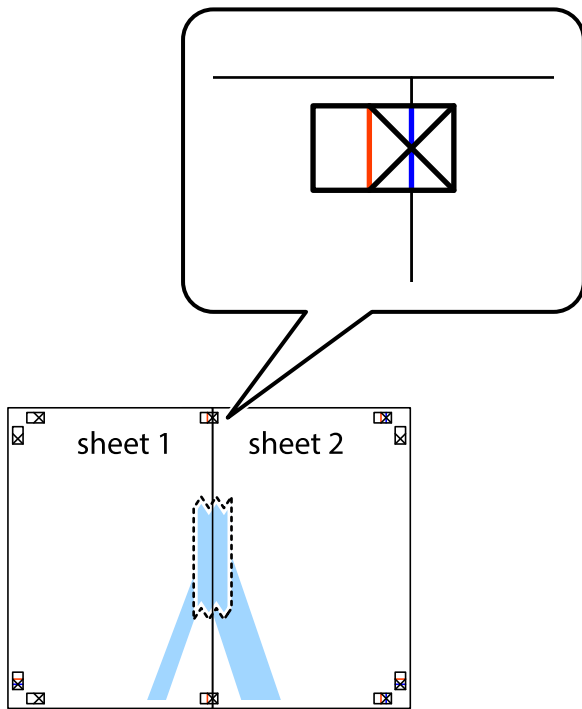

3. Cut the taped sheets in two along the vertical red line through the alignment markers (this time, the line to the left of the cross marks).

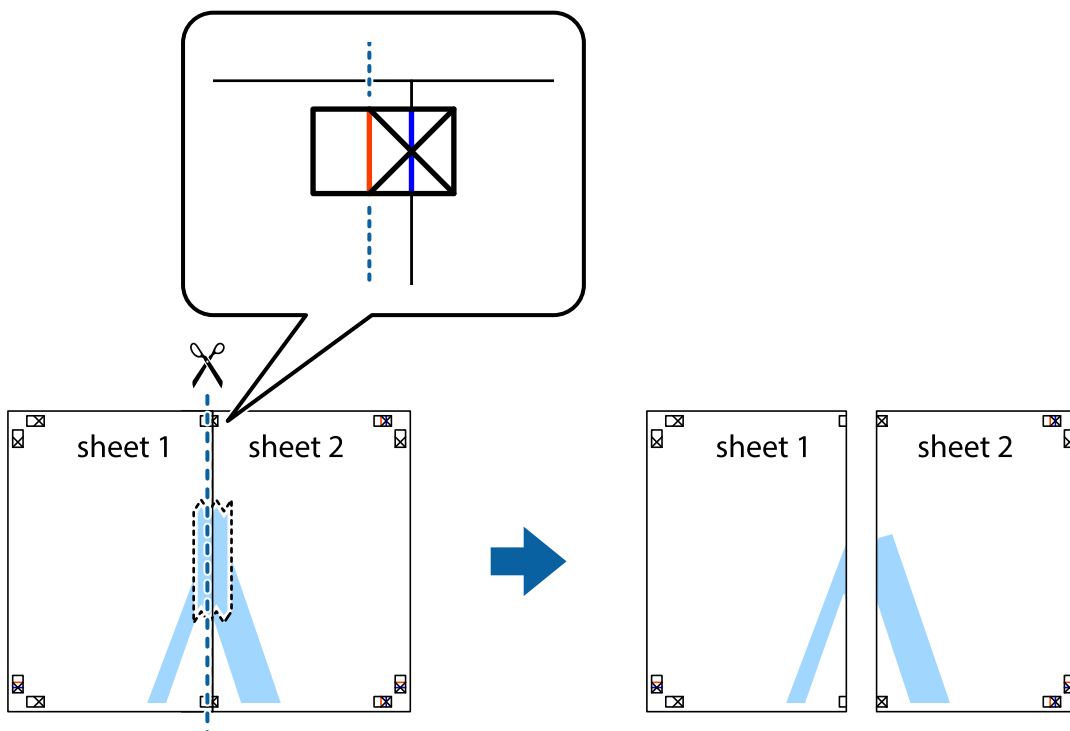

Printing

4. Tape the sheets together from the back.



5. Repeat steps 1 to 4 to tape Sheet 3 and Sheet 4 together.
6. Cut off the margins of Sheet 1 and Sheet 2 along the horizontal blue line through the center of the left and right side cross marks.

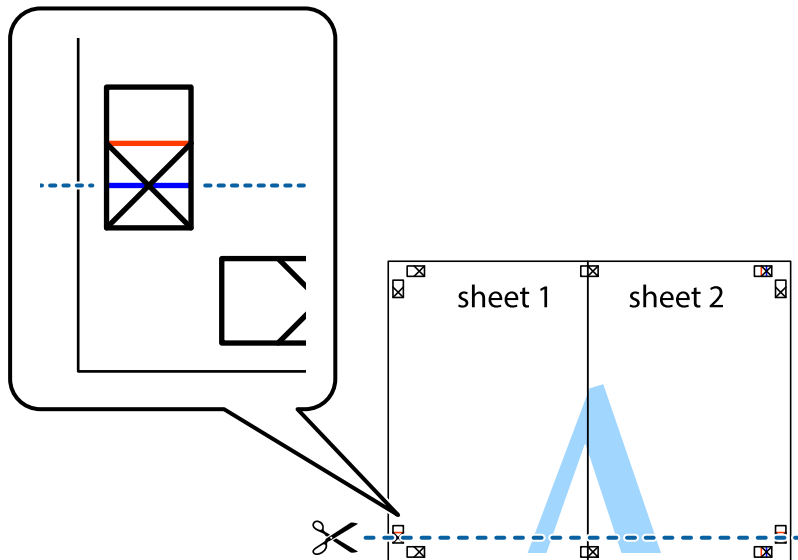

Printing

7. Place the edge of Sheet 1 and Sheet 2 on top of Sheet 3 and Sheet 4 and align the cross marks, and then temporarily tape them together from the back.

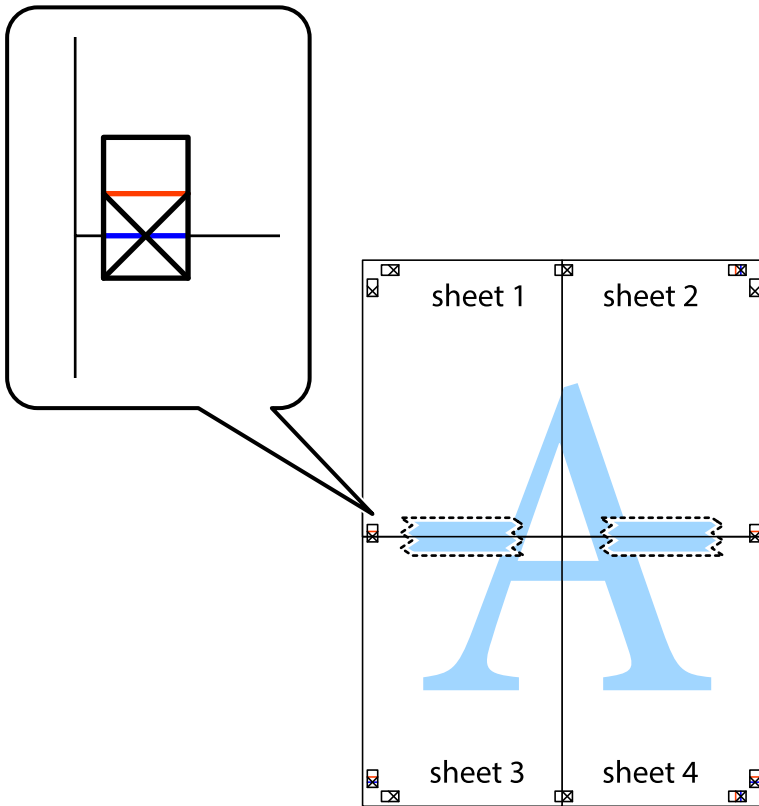

Printing

- Cut the taped sheets in two along the horizontal red line through the alignment markers (this time, the line above the cross marks).

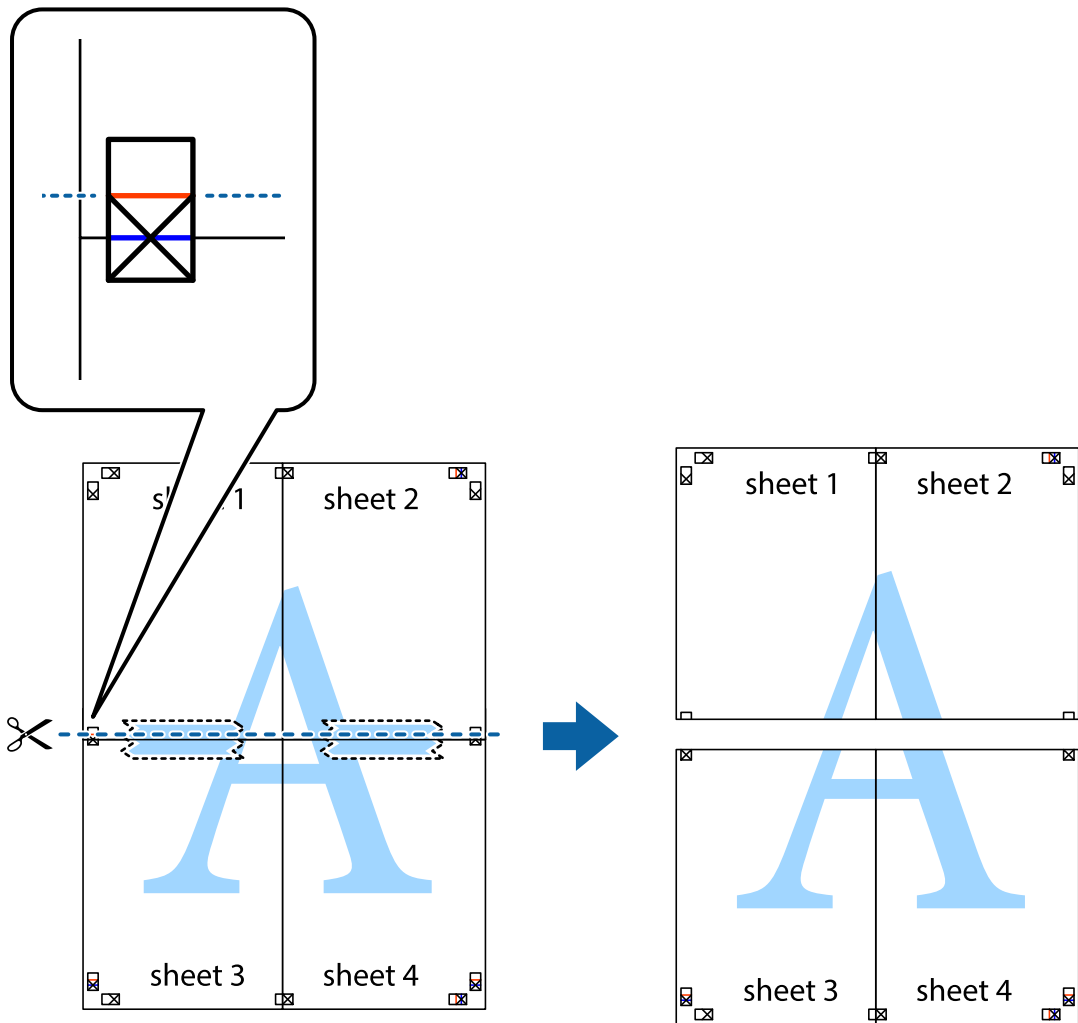

- Tape the sheets together from the back.

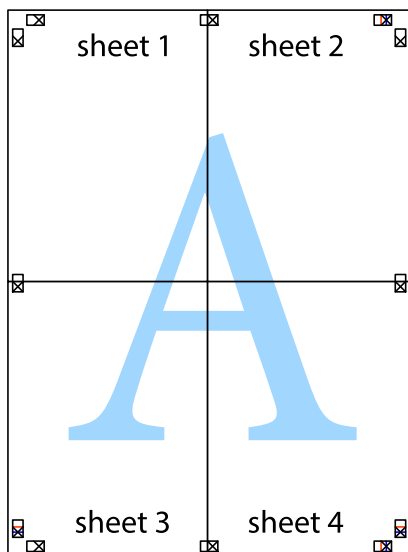

Printing

10. Cut off the remaining margins along the outer guide.

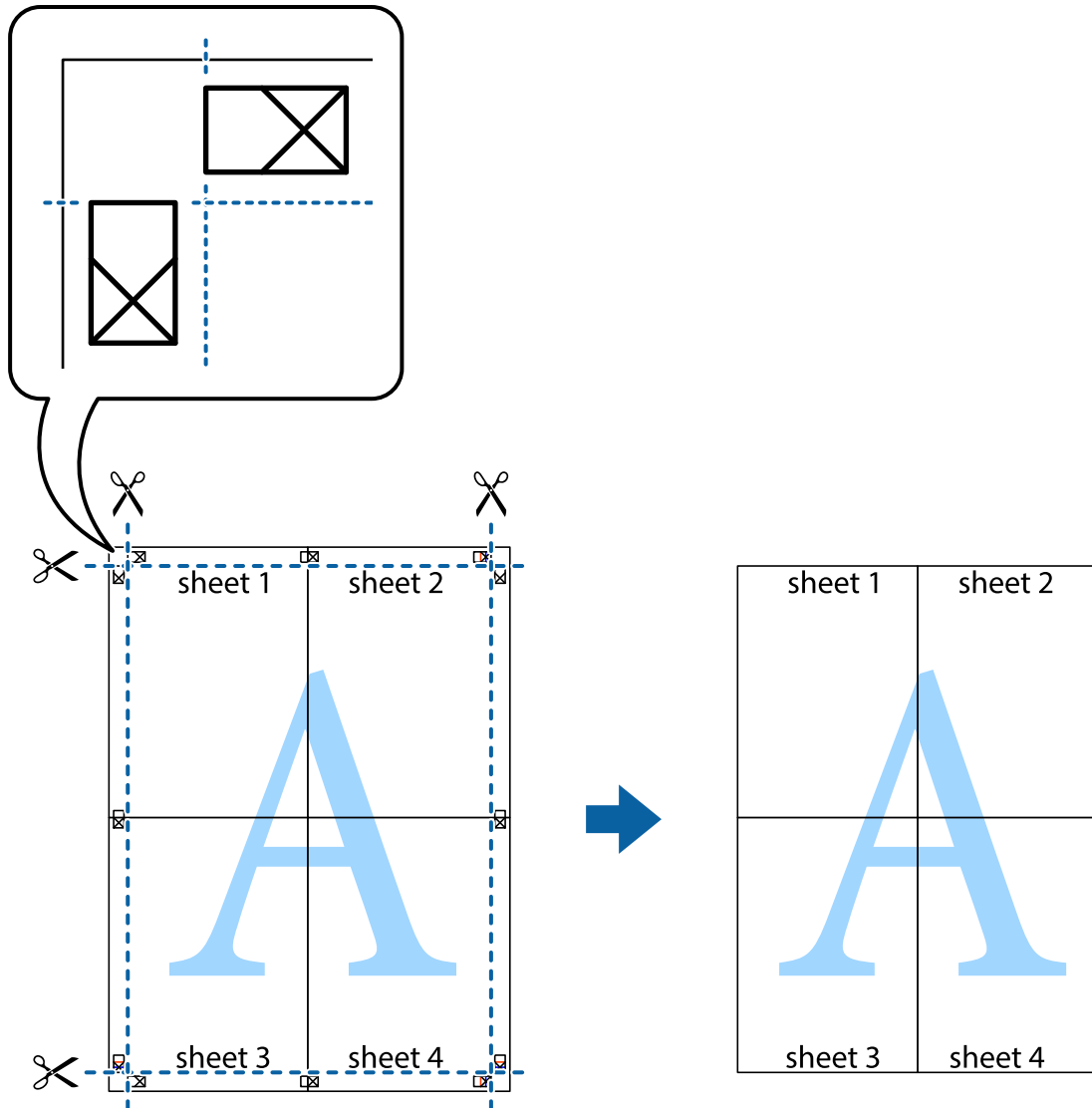

Printing with a Header and Footer

You can print information such as a user name and printing date in headers or footers.

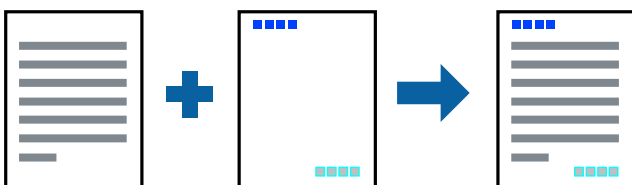

Print Settings

On the printer driver's **More Options** tab, click **Watermark Features**, and then select **Header/Footer**. Click **Settings**, and then select the items you want to print.

Printing

Related Information

- ➔ [“Printing Basics” on page 54](#)
- ➔ [“More Options Tab” on page 71](#)

Printing a Watermark

You can print a watermark such as "Confidential" on your printouts. You can also add your own watermark.

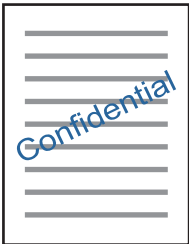

Note:

This feature is not available with borderless printing.

Print Settings

On the printer driver's **More Options** tab, click **Watermark Features**, and then select Watermark. Click **Settings** to change details such as the size, density, or position of the watermark.

Related Information

- ➔ [“Printing Basics” on page 54](#)
- ➔ [“More Options Tab” on page 71](#)

Printing Multiple Files Together

Job Arranger Lite allows you to combine several files created by different applications and print them as a single print job. You can specify the print settings for combined files, such as multi-page layout, and 2-sided printing.

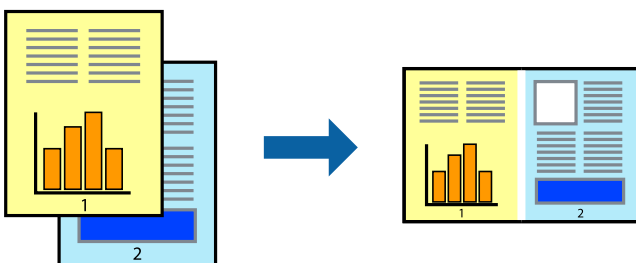

Print Settings

On the printer driver's **Main** tab, select **Job Arranger Lite**. When you start printing, the Job Arranger Lite window is displayed. With the Job Arranger Lite window opened, open the file that you want to combine with the current file, and then repeat the above steps.

Printing

When you select a print job added to Print Project in the Job Arranger Lite window, you can edit the page layout.

Click **Print** from the **File** menu to start printing.

Note:

*If you close the Job Arranger Lite window before adding all the print data to the Print Project, the print job you are currently working on is canceled. Click **Save** from the **File** menu to save the current job. The extension of the saved files is ".ecl".*

*To open a Print Project, click **Job Arranger Lite** on the printer driver's **Maintenance** tab to open the Job Arranger Lite window. Next, select **Open** from the **File** menu to select the file.*

Related Information

- ➔ ["Printing Basics" on page 54](#)
- ➔ ["Main Tab" on page 70](#)

Printing Using the Color Universal Print Feature

You can enhance the visibility of texts and images in printouts.

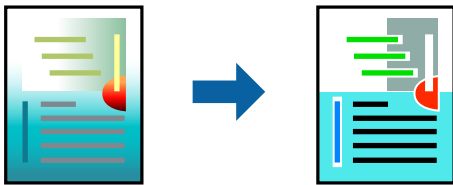

Color Universal Print is only available when the following settings are selected.

- Paper Type: Plain paper
- Quality: **Standard** or a higher quality
- Print Color: **Color**
- Applications: Microsoft® Office 2007 or later
- Text Size: 96 pts or smaller

Print Settings

On the printer driver's **More Options** tab, click **Image Options** in the **Color Correction** setting. Select an option from the **Color Universal Print** setting. Click **Enhancement Options** to make further settings.

Note:

- Certain characters may be altered by patterns, such as "+" appearing as "±".*
- Application-specific patterns and underlines may alter content printed using these settings.*
- Print quality may decrease in photos and other images when using Color Universal Print settings.*
- Printing is slower when using Color Universal Print settings.*

Related Information

- ➔ ["Printing Basics" on page 54](#)
- ➔ ["More Options Tab" on page 71](#)

Adjusting the Print Color

You can adjust the colors used in the print job.

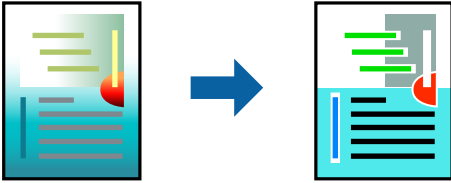

Note:

These adjustments are not applied to the original data.

Print Settings

On the printer driver's **More Options** tab, select **Custom** as the **Color Correction** setting. Click **Advanced** to open the **Color Correction** window, and then select the method of color correction.

Note:

- Automatic** is selected as default on the **More Options** tab. With this setting, the colors are automatically adjusted to match the paper type and print quality settings.
- PhotoEnhance** on the **Color Correction** window adjusts the color by analyzing the location of the subject. Therefore, if you have changed the location of the subject by reducing, enlarging, cropping, or rotating the image, the color may change unexpectedly. Selecting the borderless setting also changes the location of the subject resulting in changes in color. If the image is out of focus, the tone may be unnatural. If the color is changed or becomes unnatural, print in a mode other than **PhotoEnhance**.

Related Information

- ➔ [“Printing Basics” on page 54](#)
- ➔ [“More Options Tab” on page 71](#)

Printing to Emphasize Thin Lines

You can thicken thin lines that are too thin to print.

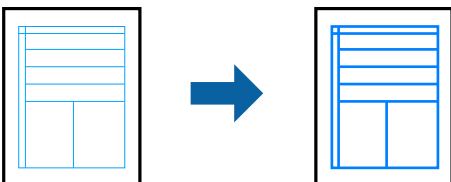

Print Settings

On the printer driver's **More Options** tab, click **Image Options** in the **Color Correction** setting. Select **Emphasize Thin Lines**.

Printing

Related Information

- ➔ [“Printing Basics” on page 54](#)
- ➔ [“More Options Tab” on page 71](#)

Printing Clear Bar Codes

You can print a bar code clearly and make it easy to scan. Only enable this feature if the bar code you printed cannot be scanned.

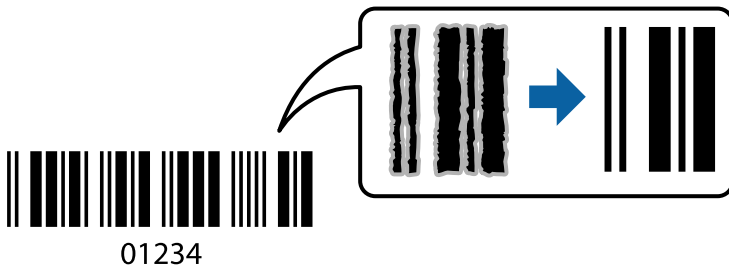

You can use this feature under the following conditions.

- Paper: Plain paper, Copy paper, or Envelope
- Quality: **Standard**, **Standard-Vivid**

The print quality may be changed when printing. The print speed may become slower and print density may become higher.

Note:

Deblurring may not always be possible depending on the circumstances.

Print Settings

On the printer driver's **Maintenance** tab, click **Extended Settings**, and then select **Barcode mode**.

Related Information

- ➔ [“Printing Basics” on page 54](#)
- ➔ [“Maintenance Tab” on page 71](#)

Canceling Printing

You can cancel a print job from the computer. However, you cannot cancel a print job from the computer once it has been completely sent to the printer. In this case, cancel the print job by using the printer's control panel.

Canceling

On your computer, right-click on your printer in **Devices and Printers**, **Printer**, or in **Printers and Faxes**. Click **See what's printing**, right-click on the job you want to cancel, and then select **Cancel**.

Printing

Menu Options for the Printer Driver

Open the print window in an application, select the printer, and then access the printer driver window.

Note:

Menus vary depending on the option you selected.

Main Tab

Printing Presets	Add/Remove Presets	You can add or remove your own presets for frequently used print settings. Select the preset you want to use from the list.
Show Settings	Displays a list of items currently set on the Main and More Options tabs.	
Reset Defaults	Return all settings to their factory default values. The settings on the More Options tab are also reset to their defaults.	
Ink Levels	Displays the approximate ink levels.	
Paper Source	Select the paper source from which the paper is fed. Select Auto Select to automatically select the paper source selected in the print settings on the printer's control panel. If the printer has only one paper source, this item is not displayed.	
Document Size	Select the paper size on which you want to print. If you select User-Defined , enter the paper width and height.	
Borderless	Enlarges the print data slightly more than the paper size so that no margins are printed around the edges of the paper. Click Settings to select the amount of enlargement.	
Orientation	Select the orientation you want to use to print.	
Paper Type	Select the type of paper on which you print.	
Quality	Select the print quality you want to use for printing. Available settings depend on the paper type you select. Click More Settings to make further settings.	
Color	Select the color for your print job.	
2-Sided Printing	Allows you to perform 2-sided printing.	
	Settings	You can specify the binding edge and the binding margins. When printing multi-page documents, you can select to print starting from either the front or the back side of the page.
	Print Density	Select the document type to adjust the print density. If the appropriate print density is selected, you can prevent images from bleeding through to the reverse side. Select User Defined to adjust the print density manually.
Multi-Page	Allows you to print several pages on one sheet or perform poster printing. Click Page Order to specify the order in which pages are printed.	
Copies	Set the number of copies you want to print.	
	Collate	Prints multi-page documents collated in order and sorted into sets.
	Reverse Order	Allows you to print from the last page so that the pages are stacked in the correct order after printing.
Quiet Mode	Reduces the noise the printer makes. However, enabling this may reduce print speed.	

Printing

Print Preview	Displays a preview of your document before printing.
Job Arranger Lite	Select to print using the Job Arranger Lite feature.

More Options Tab

Printing Presets	Add/Remove Presets	You can add or remove your own presets for frequently used print settings. Select the preset you want to use from the list.
Show Settings	Displays a list of items currently set on the Main and More Options tabs.	
Reset Defaults	Return all settings to their factory default values. The settings on the Main tab are also reset to their defaults.	
Document Size	Select the size of your document.	
Output Paper	Select the paper size on which you want to print. If the Output Paper differs from the Document Size , Reduce/Enlarge Document is selected automatically. You do not have to select it when printing without reducing or enlarging the size of a document.	
Reduce/Enlarge Document	Allows you to reduce or enlarge the size of a document.	
	Fit to Page	Automatically reduce or enlarge the document to fit to the paper size selected in Output Paper .
	Zoom to	Prints with a specific percentage.
Color Correction	Center	Prints images in the center of the paper.
	Automatic	Adjusts the colors of images automatically.
	Custom	Allows you to perform manual color correction. Click Advanced for further settings.
Image Options	Enables print quality options such as Color Universal Print or Fix Red-Eye. You can also thicken thin lines to make them visible on the printouts.	
Watermark Features	Allows you to make settings for watermarks.	
Additional Settings	Rotate 180°	Rotates pages 180 degrees before printing. This feature is helpful when printing on paper such as envelopes that are loaded in fixed direction in the printer.
	High Speed	Prints when the print head moves in both directions. The print speed is faster, but the quality may decline.
	Mirror Image	Inverts an image to print as it would appear in a mirror.

Maintenance Tab

Nozzle Check	Prints a nozzle check pattern to check if the print head nozzles are clogged.
Head Cleaning	Cleans the clogged nozzles in the print head. Because this feature uses some ink, clean the print head only if the nozzles are clogged.
Power Cleaning	Replaces all of the ink inside the ink tubes to improve the print quality.

Printing

Job Arranger Lite	Opens the Job Arranger Lite window. Here you can open and edit previously saved data.
EPSON Status Monitor 3	Opens the EPSON Status Monitor 3 window. Here you can confirm the status of the printer and the consumables.
Monitoring Preferences	Allows you to make settings for items on the EPSON Status Monitor 3 window.
Extended Settings	Allows you to make a variety of settings. Right-click each item to view the Help for more details.
Print Queue	Displays the jobs waiting to be printed. You can check, pause, or resume print jobs.
Printer and Option Information	Displays the number of sheets of paper fed into the printer.
Language	Changes the language used on the printer driver window. To apply the settings, close the printer driver, and then open it again.
Software Update	Starts EPSON Software Updater to check for the latest version of applications on the Internet.
Technical Support	Allows you to access the Epson technical support website.

Printing from the Printer Driver on Mac OS

Printing Basics

Note:

Operations differ depending on the application. See the application's help for details.

1. Open the file you want to print.
Load paper in the printer if it has not already been loaded.
2. Select **Print** from the **File** menu or another command to access the print dialog.
If necessary, click **Show Details** or ▼ to expand the print window.
3. Select your printer.

Printing

4. Select **Print Settings** from the pop-up menu.

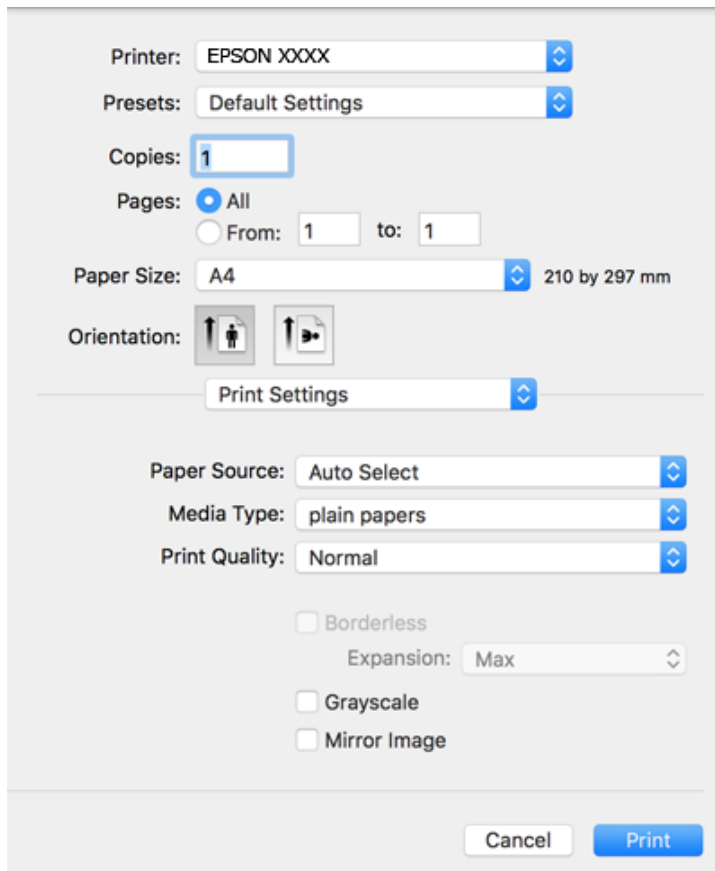

Note:

On OS X Mountain Lion or later, if the **Print Settings** menu is not displayed, the Epson printer driver has not been installed correctly.

Select **System Preferences** from the  menu > **Printers & Scanners** (or **Print & Scan**, **Print & Fax**), remove the printer, and then add the printer again. See the following to add a printer.

<http://epson.sn>

5. Change the settings as necessary.
See the menu options for the printer driver for details.
6. Click **Print**.

Related Information

- ➔ “Available Paper and Capacities” on page 37
- ➔ “Loading Paper in the Rear Paper Feed” on page 39
- ➔ “List of Paper Type” on page 42
- ➔ “Menu Options for Print Settings” on page 78

Printing on 2-Sides

You can print on both sides of the paper.

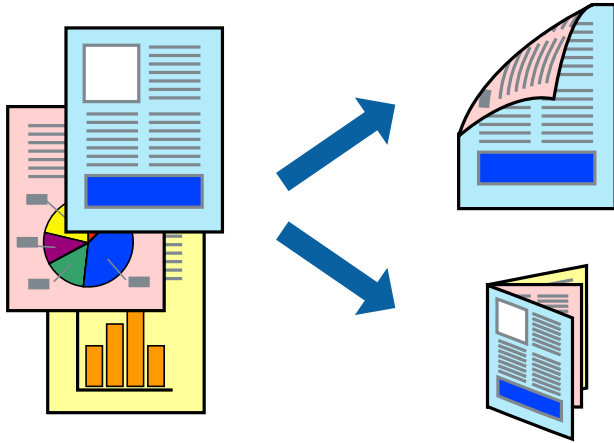

Note:

- This feature is not available for borderless printing.
- If you do not use paper that is suitable for 2-sided printing, the print quality may decline and paper jams may occur.
- Depending on the paper and the data, ink may bleed through to the other side of the paper.

Related Information

➔ [“Available Paper and Capacities” on page 37](#)

Print Settings

Select **Two-sided Printing Settings** from the pop-up menu. Select the method of 2-sided printing, and then make the **Document Type** settings.

Note:

- Printing speed may be reduced depending on the document type.
- When printing photos with dense data, select **Text & Graphics** or **Text & Photos** in the **Document Type** setting. If the printouts are smeared or ink bleeds through to the other side of the paper, adjust the **Print Density** and **Increased Ink Drying Time** in **Adjustments**.

Related Information

- ➔ [“Printing Basics” on page 72](#)
- ➔ [“Menu Options for Two-sided Printing Settings” on page 79](#)

Printing

Printing Several Pages on One Sheet

You can print two or four pages of data on a single sheet of paper.

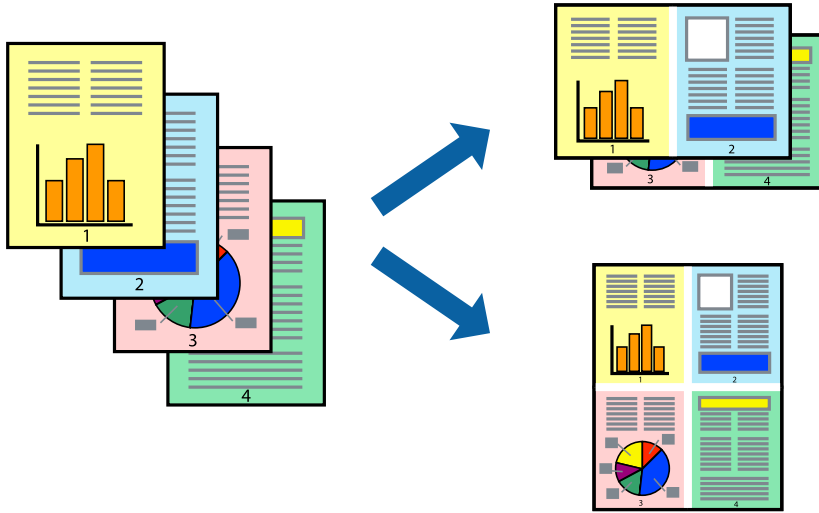

Print Settings

Select **Layout** from the pop-up menu. Set the number of pages in **Pages per Sheet**, the **Layout Direction** (page order), and **Border**.

Related Information

- ➔ [“Printing Basics” on page 72](#)
- ➔ [“Menu Options for Layout” on page 78](#)

Printing and Stacking in Page Order (Reverse Order Printing)

You can print from the last page so that the documents are stacked in page order.

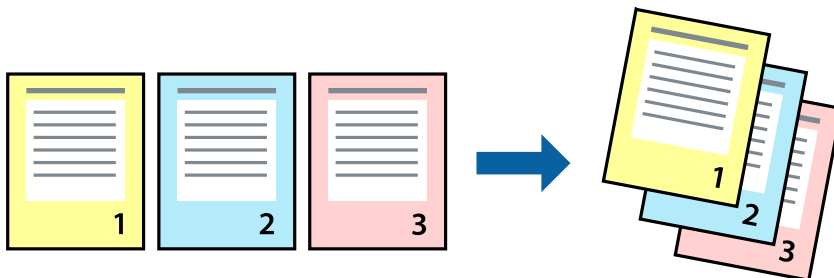

Print Settings

Select **Paper Handling** from the pop-up menu. Select **Reverse** as the **Page Order** setting.

Related Information

- ➔ [“Printing Basics” on page 72](#)

Printing

➔ [“Menu Options for Paper Handling” on page 78](#)

Printing a Reduced or Enlarged Document

You can reduce or enlarge the size of a document by a specific percentage or to fit the paper size you loaded in the printer.



Print Settings

When printing to fit to the paper size, select **Paper Handling** from the pop-up menu, and then select **Scale to fit paper size**. Select the paper size you loaded in the printer in **Destination Paper Size**. When reducing the size of the document, select **Scale down only**.

When printing at a specific percentage, do one of the following.

- Select **Print** from the **File** menu of the application. Select **Printer**, enter a percentage in **Scale**, and then click **Print**.
- Select **Page Setup** from the **File** menu of the application. Select your printer in **Format For**, enter a percentage in **Scale**, and then click **OK**.

Note:

Select the paper size you set in the application as the **Paper Size** setting.

Related Information

- ➔ [“Printing Basics” on page 72](#)
- ➔ [“Menu Options for Paper Handling” on page 78](#)

Adjusting the Print Color

You can adjust the colors used in the print job.

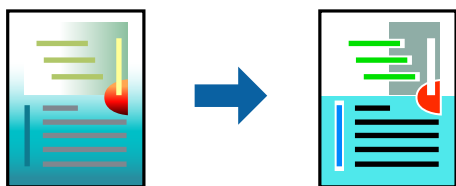

Note:

These adjustments are not applied to the original data.

Print Settings

Select **Color Matching** from the pop-up menu, and then select **EPSON Color Controls**. Select **Color Options** from the pop-up menu, and then select one of the available options. Click the arrow next to **Advanced Settings**, and then make more detailed settings.

Related Information

- ➔ [“Printing Basics” on page 72](#)
- ➔ [“Menu Options for Color Matching” on page 78](#)
- ➔ [“Menu Options for Color Options” on page 79](#)

Canceling Printing

You can cancel a print job from the computer. However, you cannot cancel a print job from the computer once it has been completely sent to the printer. In this case, cancel the print job by using the printer's control panel.

Canceling

Click the printer icon in the **Dock**. Select the job you want to cancel, and then do one of the following.

- OS X Mountain Lion or later

Click  next to the progress meter.

- Mac OS X v10.6.8 to v10.7.x

Click **Delete**.

Menu Options for the Printer Driver

Open the print window in an application, select the printer, and then access the printer driver window.

Note:

Menus vary depending on the option you selected.

Printing

Menu Options for Layout

Pages per Sheet	Select the number of pages to be printed on one sheet.
Layout Direction	Specify the order in which the pages will be printed.
Border	Prints a border around the pages.
Reverse page orientation	Rotates pages 180 degrees before printing. Select this item when printing on paper such as envelopes that are loaded in fixed direction in the printer.
Flip horizontally	Inverts an image to print as it would appear in a mirror.

Menu Options for Color Matching

ColorSync	Select the method for color adjustment. These options adjust colors between the printer and the computer display to minimize the difference in color.
EPSON Color Controls	

Menu Options for Paper Handling

Collate pages	Prints multi-page documents collated in order and sorted into sets.	
Pages to Print	Select to print only odd pages or even pages.	
Page Order	Select to print from the top or the last page.	
Scale to fit paper size	Prints to fit to the paper size you loaded.	
	Destination Paper Size	Select the paper size to print on.
	Scale down only	Select when reducing the size of the document.

Menu Options for Cover Page

Print Cover Page	Select whether or not to print a cover page. When you want to add a back cover, select After document .
Cover Page Type	Select the contents of the cover page.

Menu Options for Print Settings

Paper Source	Select the paper source from which the paper is fed. If the printer has only one paper source, this item is not displayed. Selecting Auto Select selects the paper source that matches the paper setting on the printer automatically.
Media Type	Select the type of paper on which you print.
Print Quality	Select the print quality you want to use for printing. The options vary depending on the paper type.

Printing

Borderless	This checkbox is selected when you select a borderless paper size.	
	Expansion	In borderless printing, the print data is enlarged slightly more than the paper size so that no margins are printed around the edges of the paper. Select the amount of enlargement.
Grayscale	Select when you want to print in black or shades of gray.	
Mirror Image	Inverts an image to print as it would appear in a mirror.	

Menu Options for Color Options

Manual Settings	Adjusts the color manually. In Advanced Settings , you can select detailed settings.
PhotoEnhance	Produces sharper images and more vivid colors by automatically adjusting the contrast, saturation, and brightness of the original image data.
Off (No Color Adjustment)	Print without enhancing or adjusting the color in any way.

Menu Options for Two-sided Printing Settings

Two-sided Printing	Prints on both sides of the paper.
--------------------	------------------------------------

Making Operation Settings for the Mac OS Printer Driver

Accessing the Operation Settings Window of the Mac OS Printer Driver

Select **System Preferences** from the  menu > **Printers & Scanners** (or **Print & Scan**, **Print & Fax**), and then select the printer. Click **Options & Supplies** > **Options** (or **Driver**).

Operation Settings of the Mac OS Printer Driver

- Skip Blank Page: Avoids printing blank pages.
- Quiet Mode: Prints quietly. However, the print speed may be slower.
- Output documents for filing: Feed the paper so that it is easy to file when printing landscape data or 2-sided printing. Envelope printing is not supported.
- High Speed Printing: Prints when the print head moves in both directions. The print speed is faster, but the quality may decline.
- Remove white borders: Removes unnecessary margins during borderless printing.
- Warning Notifications: Allows the printer driver to display warning notifications.
- Establish bidirectional communication: Usually, this should be set to **On**. Select **Off** when acquiring the printer information is impossible because the printer is shared with Windows computers on a network or for any other reason.

Printing from the Control Panel

Printing Photos by Selecting from a Memory Card

1. Load paper in the printer.
2. Insert a memory card into the printer.

! *Important:*
Do not remove the memory card until you have finished printing.

3. Select **Print Photos** on the home screen.

To select an item, move the focus to the item using the ▲▼◀▶ buttons, and then press the OK button.

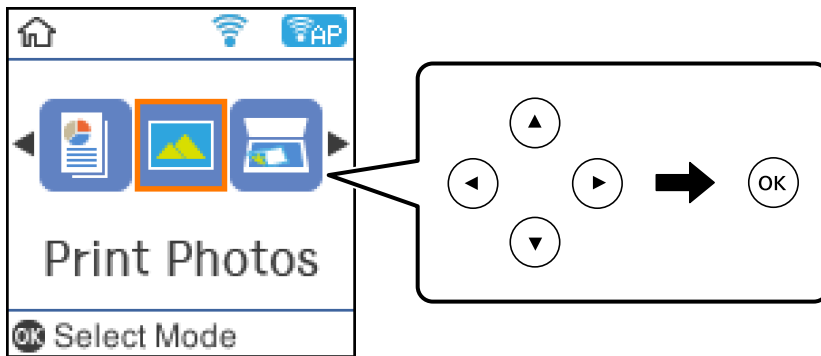

4. Select a photo, and then set the number of copies. When printing more than one photo, repeat this procedure.
5. Press the OK button to display the print settings confirmation screen.
6. If you want to change the print settings, press the ▼ button to display the setting screen.
7. Set the items as necessary.
8. When you have finished making settings, press the OK button.
9. Press the ◊ button.

Printing

Printing Lined Paper, Calendars, and Original Writing Paper

You can easily print lined paper, calendars, and original writing paper using the **Personal Stationery** menu.

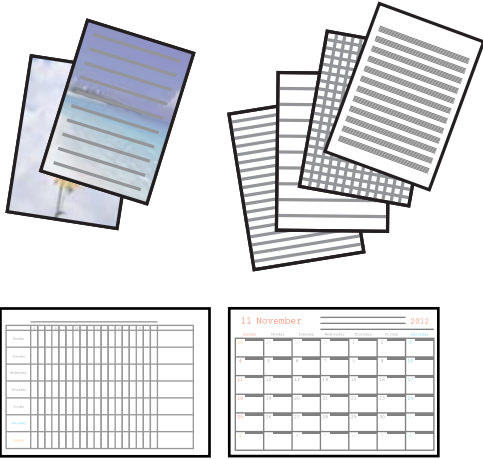

1. Load paper in the printer.
2. To print writing paper using a photo on your memory card, insert the memory card into the printer.
3. Select **Personal Stationery** on the home screen.

To select an item, move the focus to the item using the ▲ ▼ ◀ ▶ buttons, and then press the OK button.

4. Select a menu item.
5. Follow the on-screen instructions to print.

Menu Options for Printing Lined Paper, Calendars, and Original Writing Paper

Lined Papers:

Prints some types of lined paper, graph paper, or music paper on A4 size paper.

Writing Papers:

Prints some types of writing paper on A4 size paper with a photo from the memory card set as the background. The photo is printed lightly so that it can be easily written on.

Calendar:

Prints a weekly or monthly calendar. Select the year and the month for the monthly calendar.

Menu Options for Print Photos

Paper Size:

Select the paper size you loaded.

Printing

Paper Type:

Select the paper type you loaded.

Borderless:

To print without margins around the edges, select **Borderless**. The image is enlarged a little to remove margins from the edges of the paper. Select how much to enlarge the image in the **Expansion** setting. To print with margins around the edges, select **With Border**.

Quality:

Select the print quality. Selecting **Best** provides higher quality printing, but the printing speed may be slower.

-Fix Photo:

Select one of the image adjustment options. Select **Auto** to produce sharper images and more vivid colors by automatically adjusting the contrast, saturation, and brightness of the original image data.

Fix Red-Eye:

Fixes red-eye in photos. Corrections are not applied to the original file, only to the printouts. Depending on the type of photo, parts of the image other than the eyes may be corrected.

Printing from Smart Devices

Using Epson iPrint

Epson iPrint is an application that allows you to print photos, documents, and web pages from a smart device such as a smartphone or tablet. You can use local print, printing from a smart device that is connected to the same wireless network as your printer, or remote print, printing from a remote location over the Internet. To use remote print, register your printer in the Epson Connect service.



Related Information

➔ [“Printing Using a Network Service” on page 126](#)

Installing Epson iPrint

You can install Epson iPrint on your smart device from the following URL or QR code.

Printing

<http://ipr.to/c>



Printing Using Epson iPrint

Start Epson iPrint from your smart device and select the item you want to use from the home screen.

The following screens are subject to change without notice. The contents may vary depending on the product.

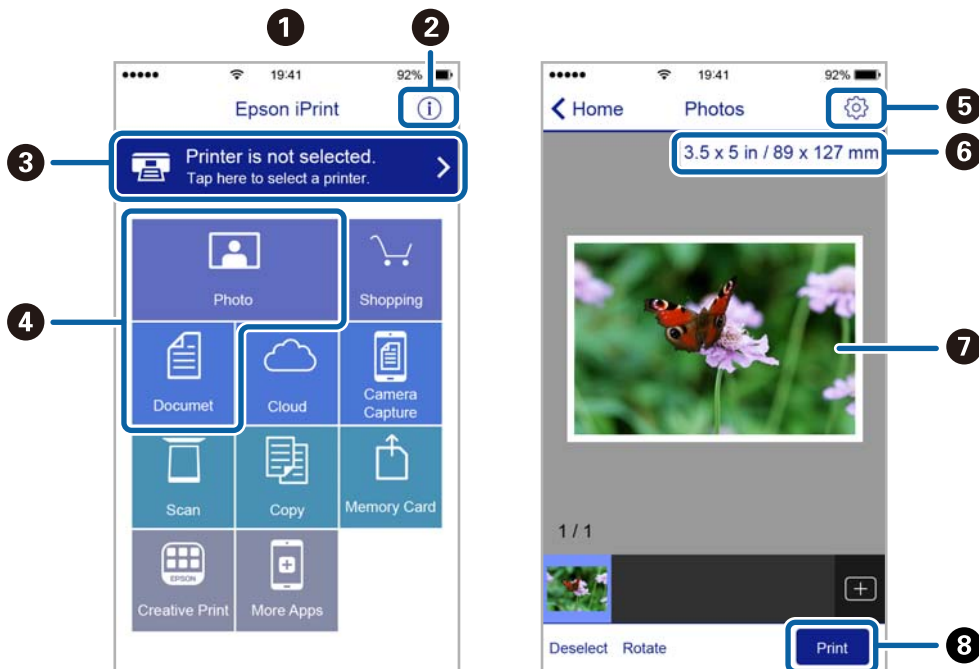

1	Home screen displayed when the application is started.
2	Displays information on how to setup the printer and a FAQ.
3	Displays the screen where you can select the printer and make printer settings. Once you have selected the printer, you do not need to select it again from the next time.
4	Select what you want to print such as photos and documents.
5	Displays the screen to make print settings such as paper size and paper type.
6	Displays the paper size. When this is displayed as a button, press it to display the paper settings currently set on the printer.
7	Displays photos and documents you selected.
8	Starts printing.

Printing

Note:

To print from the document menu using iPhone, iPad, and iPod touch running iOS, start Epson iPrint after transferring the document you want to print using the file sharing function in iTunes.

Using Epson Print Enabler

You can wirelessly print your documents, emails, photos, and web pages right from your Android phone or tablet (Android v4.4 or later). With a few taps, your Android device will discover an Epson printer that is connected to the same wireless network.

1. Load paper in the printer.
2. Set up your printer for wireless printing.
3. On your Android device, install the Epson Print Enabler plug-in from Google Play.
4. Connect your Android device to the same wireless network as your printer.
5. Go to **Settings** on your Android device, select **Printing**, and then enable Epson Print Enabler.
6. From an Android application such as Chrome, tap the menu icon and print whatever is on the screen.

Note:

If you do not see your printer, tap **All Printers** and select your printer.

Related Information

- ➔ “Loading Paper in the Rear Paper Feed” on page 39
- ➔ “Connecting to a Smart Device” on page 23

Using AirPrint

AirPrint enables instant wireless printing from iPhone, iPad, iPod touch, and Mac without the need to install drivers or download software.

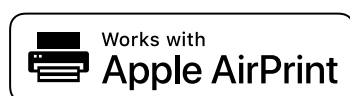
**Note:**

If you disabled paper configuration messages on your product control panel, you cannot use AirPrint. See the link below to enable the messages, if necessary.

1. Load paper in your product.
2. Set up your product for wireless printing. See the link below.
<http://epson.sn>
3. Connect your Apple device to the same wireless network that your product is using.

Printing

4. Print from your device to your product.

Note:

For details, see the AirPrint page on the Apple website.

Related Information

- ➔ [“Menu Options for Printer Setup” on page 47](#)
- ➔ [“Loading Paper in the Rear Paper Feed” on page 39](#)

Canceling the Ongoing Job

Press the  button on the printer's control panel to cancel the print job in progress.

Copying

Copying

1. Load paper in the printer.
2. Place the originals.
3. Select **Copy** on the home screen.

To select an item, move the focus to the item using the ▲ ▼ ◀ ▶ buttons, and then press the OK button.

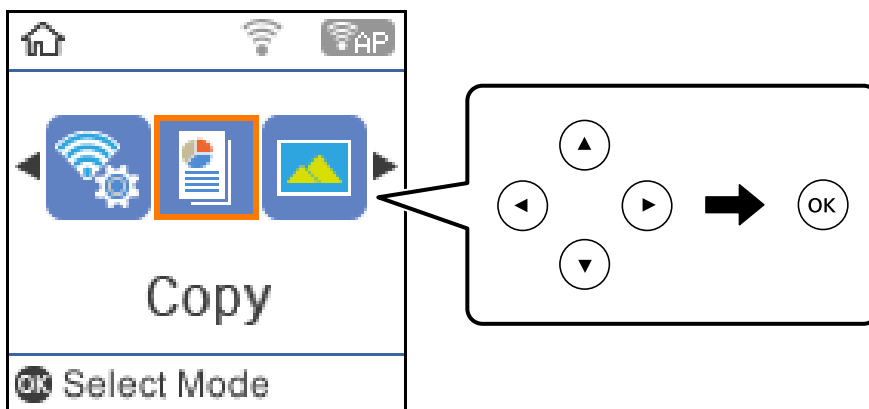

4. Set the number of copies.
5. Select color copy or monochrome copy.
6. Press the OK button to display and check the print settings. To change the settings, press the ▼ button, select the setting items and change settings. When you have finished, press the OK button.

Note:

If you want to copy by reducing or enlarging the size of a document by a specific percentage, select any item other than **Auto Fit** as the **Reduce/Enlarge** setting. Specify a percentage in **Custom Size**. You can change the percentage in increments of 10% by holding down the ◀ or ▶ button.

7. Press the ◊ button.

Note:

The color, size, and border of the copied image are slightly different from the original.

Related Information

- ➔ [“Placing Originals” on page 43](#)
- ➔ [“Menu Options for Copying” on page 87](#)

Copying on 2-Sides

1. Select **Copy** on the home screen.

To select an item, move the focus to the item using the ▲ ▼ ◀ ▶ buttons, and then press the OK button.

2. Press the OK button to display the print settings, and then press the ▼ button.
3. Select **1→2-Sided** as the **2-Sided** setting, and then press the OK button.
4. Press the ⬠ button.

Related Information

➔ [“Copying” on page 86](#)

Copying Multiple Originals onto One Sheet

1. Select **Copy** on the home screen.

To select an item, move the focus to the item using the ▲ ▼ ◀ ▶ buttons, and then press the OK button.

2. Press the OK button to display the print settings, and then press the ▼ button.
3. Select **2-up** as the **Multi-Page** setting, and then press the OK button.
4. Press the ⬠ button.

Related Information

➔ [“Copying” on page 86](#)

Menu Options for Copying

Note:

Available menus vary depending on the layout you selected.

The number of copies:

Enter the number of copies.

B&W:

Copies the original in black and white (monochrome).

Color:

Copies the original in color.

Copying

2-Sided:

Select 2-sided layout.

- 1→1-Sided

Copies one side of an original onto a single side of paper.

- 1→2-Sided

Copies two single-sided originals onto both sides of a single sheet of paper. Select the orientation of your original and the binding position of the paper.

Density:

Increase the level of density when the copying results are faint. Decrease the level of density when ink smears.

Paper Size:

Select the paper size you loaded.

Paper Type:

Select the paper type you loaded.

Reduce/Enlarge:

Enlarges or reduces the originals.

- Actual Size

Copies at 100 % magnification.

- Auto Fit

Detects the scan area and automatically enlarges or reduces the original to fit to the paper size you selected. When there are white margins around the original, the white margins from the corner mark of the scanner glass are detected as the scan area, but the margins at the opposite side may be cropped.

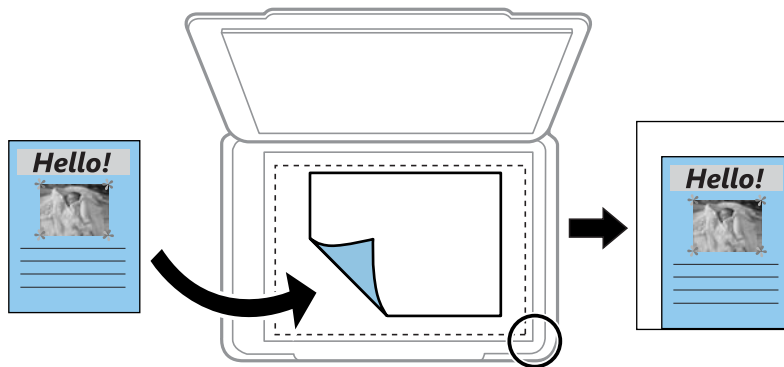

- Custom

Select to specify the magnification to enlarge or reduce the original.

Custom Size:

Specifies the magnification used to enlarge or reduce the original within a range of 25 to 400%.

Copying

Original Size:

Select the size of your original. When copying non-standard size originals, select the size closest to your original.

Multi-Page:

Single Page

Copies a single-sided original onto a single sheet.

2-up

Copies two single-sided originals onto a single sheet in 2-up layout. Select the layout order and the orientation of your original.

Quality:

Select the print quality. **Draft** provides faster printing, but the printouts may be faint. **Best** provides higher quality printing, but the printing speed may be slower.

ID Card Copy:

Scans both sides of an ID card and copies onto one side of A4 size paper.

Borderless Copy:

Copies without margins around the edges. The image is enlarged a little to remove margins from the edges of the paper. Select how much to enlarge in the **Expansion** setting.

Scanning

Scanning Using the Control Panel

You can send scanned images from the printer's control panel to the following destinations.

To Memory

You can save the scanned image to a memory card. You need not set any settings before scanning.

To Computer (JPEG)/To Computer (PDF)/To Computer (Email)

You can save the scanned image to a computer connected to the printer. Before scanning, install Epson Scan 2 and Epson Event Manager on your computer.

To Computer (WSD)

You can save the scanned image to a computer connected to the printer, using WSD feature. If you are using the Windows 7/Windows Vista, you need to make WSD settings on your computer before scanning.

Related Information

- ➔ [“Scanning to a Memory Card” on page 90](#)
- ➔ [“Scanning to a Computer \(Event Manager\)” on page 91](#)
- ➔ [“Scanning to a Computer \(WSD\)” on page 92](#)

Scanning to a Memory Card

You can save the scanned image to a memory card.

1. Insert a memory card into the printer.
2. Place the originals.
3. Select **Scan** on the home screen.

To select an item, move the focus to the item using the ▲▼◀▶ buttons, and then press the OK button.

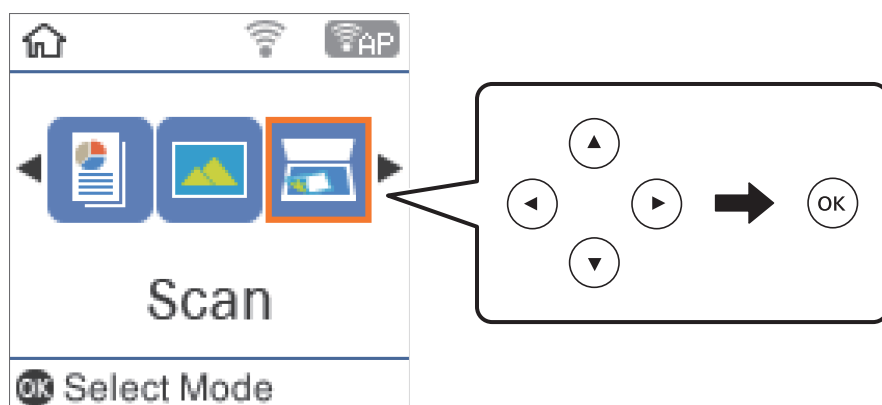

Scanning

4. Select **To Memory**.
5. Check settings such as the save format, and change them if necessary.
6. Press the  button.

Related Information

➔ [“Placing Originals” on page 43](#)

Menu Options for Scanning to a Memory Card

Note:

The items may not be available depending on other settings you made.

Format:

Select the format in which to save the scanned image.

Color:

Select whether to scan in color or in monochrome.

Scan Size:

Select the scan area. To crop the white space around the text or image when scanning, select **Auto Cropping**. To scan at the maximum area of the scanner glass, select **Max Area**.

Original Type:

Select the type of your original.

Resolution:

Select the scanning resolution.

Contrast:

Select the contrast of the scanned image.

Original Orientation:

Select the orientation of the original.

Scanning to a Computer (Event Manager)

Note:

Before scanning, install Epson Scan 2 and Epson Event Manager on your computer.

1. Place the originals.

Scanning

2. Select **Scan** on the home screen.

To select an item, move the focus to the item using the ▲▼◀▶ buttons, and then press the OK button.

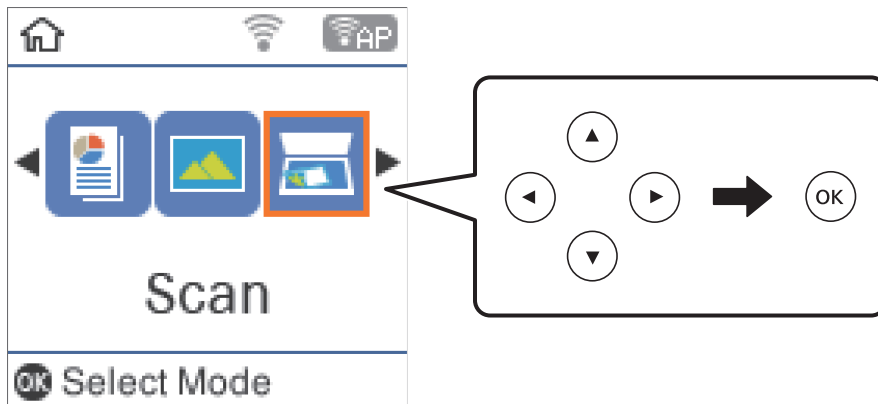

3. Select how to save the scanned image to a computer from the following menus, and then press the OK button.

- To Computer (JPEG):** Saves the scanned image in JPEG format.
- To Computer (PDF):** Saves the scanned image in PDF format.
- To Computer (Email):** Starts the email client on your computer, and then automatically attaches it to an email.

4. Select the computer to which you want to save the scanned images.

Note:

- You can change the scan settings such as the scanning size, folder to save, or save format, by using *Epson Event Manager*.
- When the printer is connected to a network, you can select the computer to which you want to save the scanned image. You can display up to 20 computers on the printer's control panel. If you set **Network Scan Name (Alphanumeric)** on *Epson Event Manager*, it is displayed on the control panel.

5. Press the ◊ button.

Related Information

➔ [“Placing Originals” on page 43](#)

Scanning to a Computer (WSD)

Note:

- This feature is only available for computers running Windows 10/Windows 8.1/Windows 8/Windows 7/Windows Vista.
- If you are using Windows 7/Windows Vista, you need to setup your computer in advance using this feature.

1. Place the originals.

Scanning

2. Select **Scan** on the home screen.

To select an item, move the focus to the item using the ▲▼◀▶ buttons, and then press the OK button.

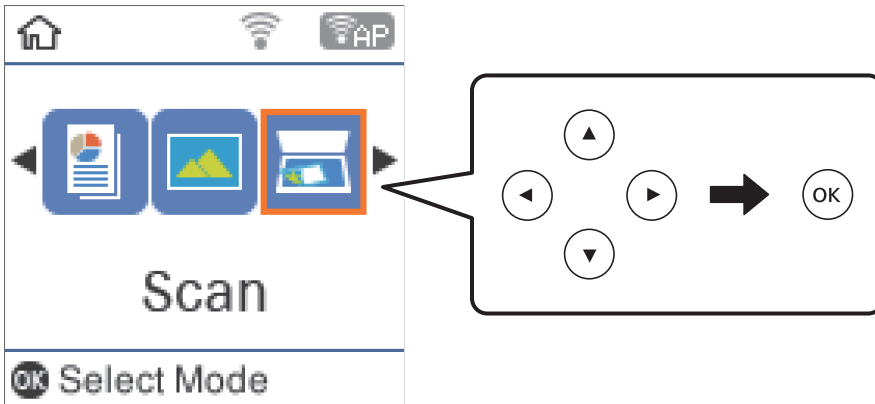

3. Select **To Computer (WSD)**.
4. Select a computer.
5. Press the ◊ button.

Setting Up a WSD Port

This section explains how to set up a WSD port for Windows 7/Windows Vista.

Note:

For Windows 10/Windows 8.1/Windows 8, the WSD port is set up automatically.

The following is necessary to set up a WSD port.

- The printer and the computer are connected to the network.
- The printer driver is installed on the computer.

1. Turn the printer on.
2. Click start, and then click **Network** on the computer.
3. Right-click the printer, and then click **Install**.
Click **Continue** when the **User Account Control** screen is displayed.

Scanning

Click **Uninstall** and start again if the **Uninstall** screen is displayed.

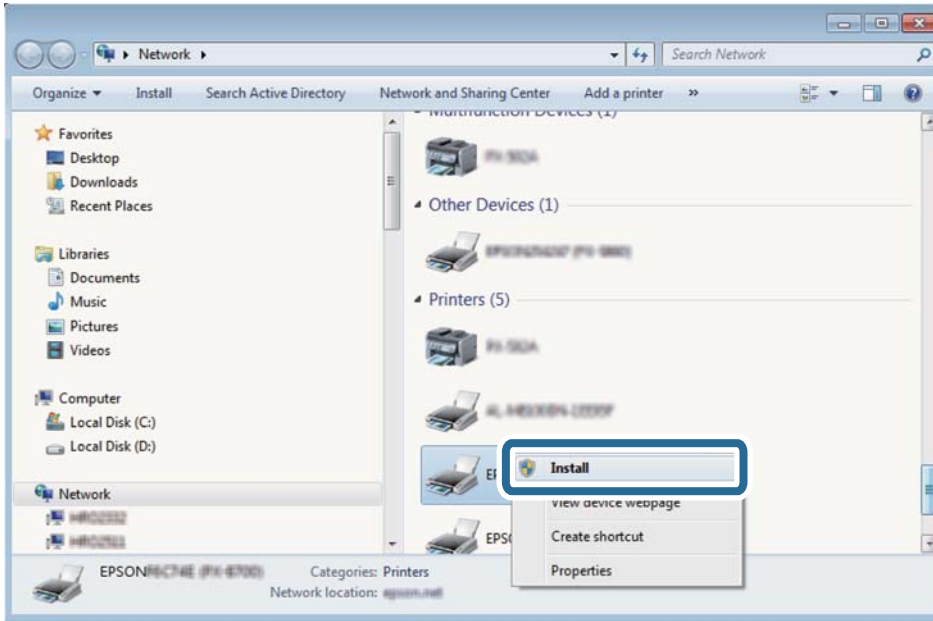

Note:

The printer name you set on the network and model name (EPSON XXXXXX (XX-XXXX)) are displayed on the network screen. You can check the printer's name set on the network from the printer's control panel or by printing a network status sheet.

4. Click **Your device is ready to use**.

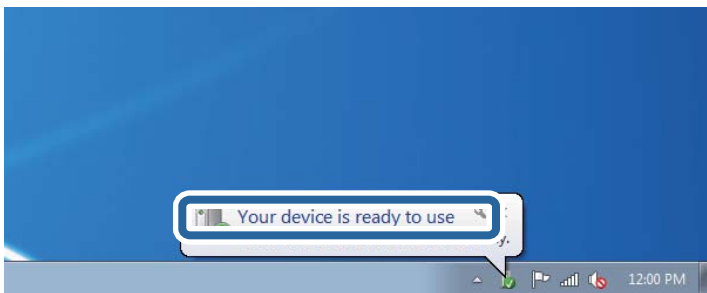

5. Check the message, and then click **Close**.

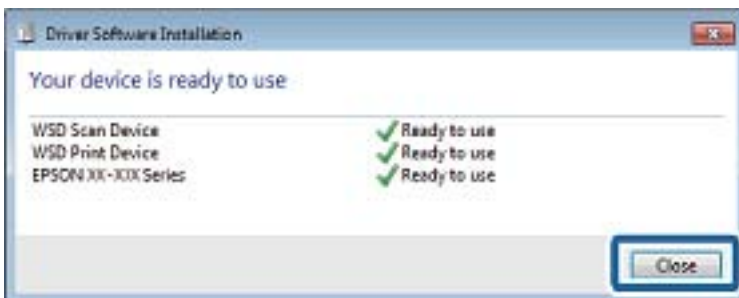

6. Open the **Devices and Printers** screen.

- Windows 7

Click start > **Control Panel** > **Hardware and Sound** (or **Hardware**) > **Devices and Printers**.

Scanning

- ❑ Windows Vista

Click start > **Control Panel** > **Hardware and Sound** > **Printers**.

7. Check that an icon with the printer's name on the network is displayed.
Select the printer name when using with WSD.

Scanning from a Computer

Scanning Using Epson Scan 2

You can scan using the scanner driver "Epson Scan 2". You can scan originals using detailed settings that are suitable for text documents.

See the Epson Scan 2 help for an explanation of each setting item.

1. Place the original.
2. Start Epson Scan 2.
3. Make the following settings on the **Main Settings** tab.

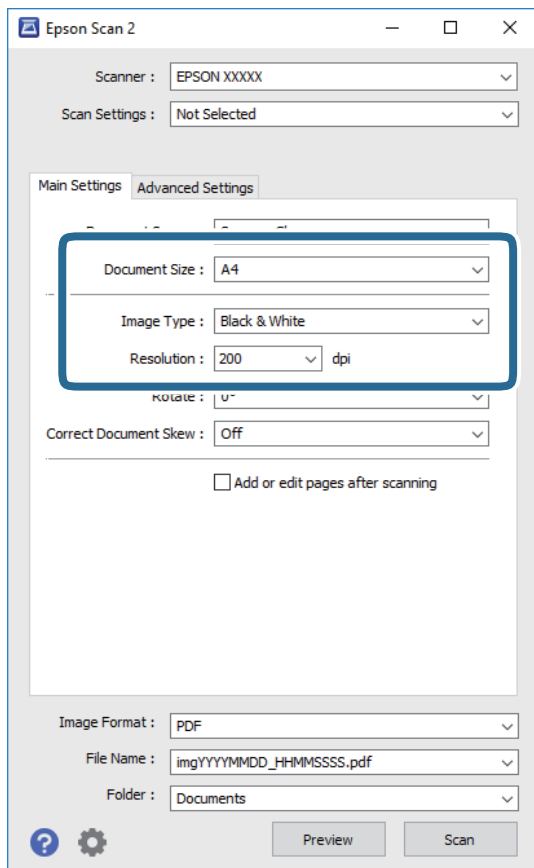

- ❑ Document Size: Select the size of the original you placed.
- ❑ Image Type: Select the color for saving the scanned image.

Scanning

- Resolution: Select the resolution.

Note:

The **Document Source** setting is fixed as **Scanner Glass**. You cannot change this setting.

4. Make other scan settings if necessary.

- You can preview the scanned image by clicking the **Preview** button. The preview window opens, and the previewed image is displayed.
- On the **Advanced Settings** tab, you can make detailed image adjustment settings that are suitable for text documents, such as the following.
 - Remove Background: Remove the background of the originals.
 - Text Enhancement: You can make blurred letters in the original clear and sharp.
 - Auto Area Segmentation: You can make letters clear and images smooth when performing black and white scanning for a document that contains images.
 - Color Enhance: You can enhance the color specified for the scanned image, and then save it in grayscale or black and white.
 - Threshold: You can adjust the border for monochrome binary (black and white).
 - Unsharp Mask: You can enhance and sharpen the outlines of the image.
 - Descreening: You can remove moiré patterns (web-like shadows) that appear when scanning printed papers such as a magazine.
 - Edge Fill: You can remove the shadow created around the scanned image.
 - Dual Image Output (Windows Only): You can scan once and save two images with different output settings at the same time.

Note:

The items may not be available depending on other settings you made.

Scanning

5. Set the file saving settings.

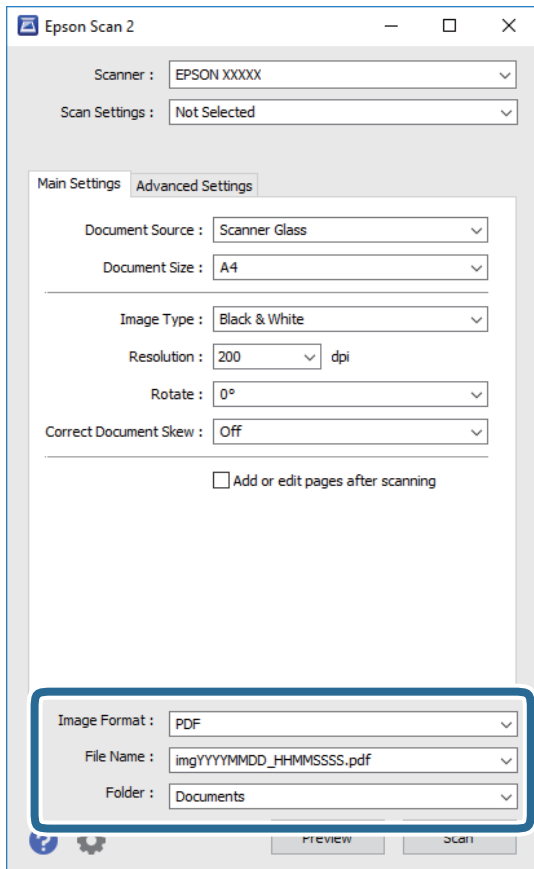

- Image Format: Select the save format from the list.
You can make detailed settings for each save format except BITMAP and PNG. Select **Options** from the list after selecting the save format.
- File Name: Confirm the save file name displayed.
You can change settings for the file name by selecting **Settings** from the list.
- Folder: Select the save folder for the scanned image from the list.
You can select another folder or create a new folder by selecting **Select** from the list.

6. Click **Scan**.

Related Information

- ➔ [“Placing Originals” on page 43](#)
- ➔ [“Application for Scanning Documents and Images \(Epson Scan 2\)” on page 119](#)

Scanning from Smart Devices

Epson iPrint is an application that allows you to scan photos and documents from a smart device, such as a smartphone or tablet, that is connected to the same wireless network as your printer. You can save the scanned data on a smart device or to Cloud services, send it by email, or print it.



Installing Epson iPrint

You can install Epson iPrint on your smart device from the following URL or QR code.

<http://ipr.to/c>



Scanning Using Epson iPrint

Start Epson iPrint from your smart device and select the item you want to use from the home screen.

Scanning

The following screens are subject to change without notice.



1	Home screen displayed when the application is started.
2	Displays information on how to setup the printer and a FAQ.
3	Displays the screen where you can select the printer and make printer settings. Once you have selected the printer, you do not need to select it again from the next time.
4	Displays the scanning screen.
5	Displays the screen where you can make scan settings such as resolution.
6	Displays scanned images.
7	Starts scanning.
8	Displays the screen where you can save scanned data to a smart device or Cloud services.
9	Displays the screen where you can send scanned data by email.
10	Displays the screen where you can print scanned data.

Refilling Ink

Checking the Ink Levels

To confirm the actual ink remaining, visually check the ink levels in all of the printer's tanks.

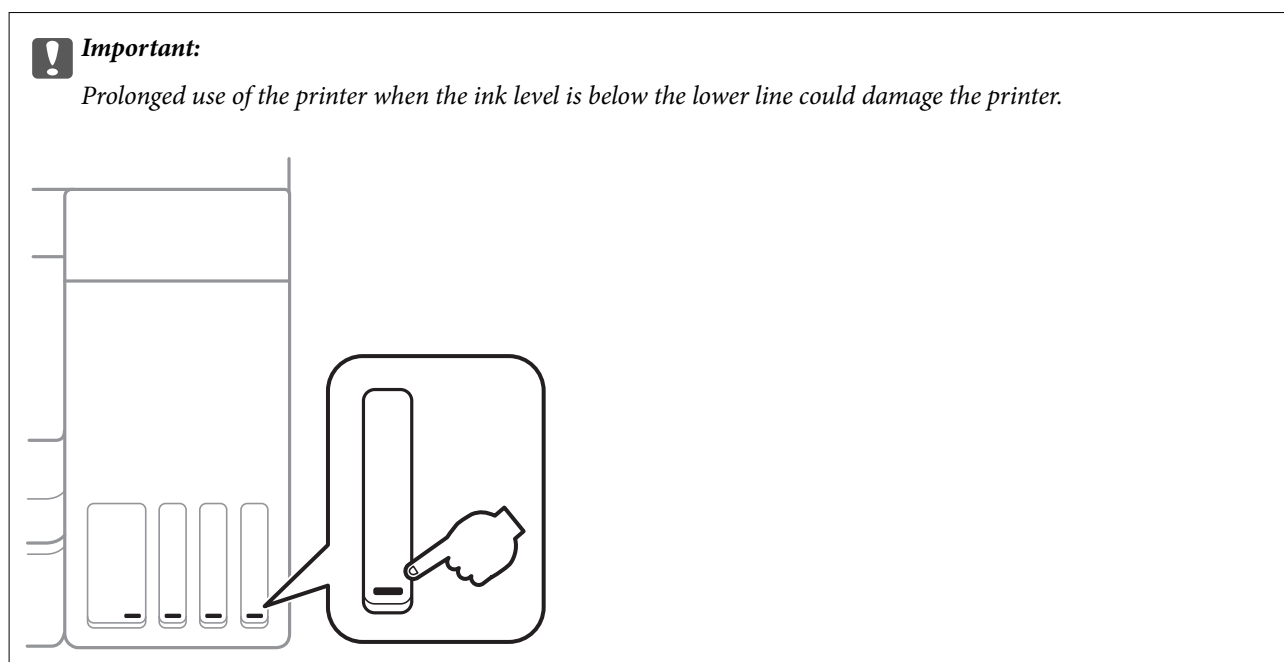

You can check the approximate ink levels from the computer.

Checking the Ink Levels - Windows

1. Access the printer driver window.
2. Click **EPSON Status Monitor 3** on the **Maintenance** tab.

Note:

If **EPSON Status Monitor 3** is disabled, click **Extended Settings** on the **Maintenance** tab, and then select **Enable EPSON Status Monitor 3**.

Related Information

➔ [“Accessing the Printer Driver” on page 54](#)

Checking the Ink Levels - Mac OS

1. Select **System Preferences** from the  menu > **Printers & Scanners** (or **Print & Scan**, **Print & Fax**), and then select the printer.
2. Click **Options & Supplies** > **Utility** > **Open Printer Utility**.

Refilling Ink

3. Click **EPSON Status Monitor**.

Ink Bottle Codes

Epson recommends the use of genuine Epson ink bottles.

The following are the codes for genuine Epson ink bottles.

For Europe

Product	BK: Black	C: Cyan	M: Magenta	Y: Yellow
ET-2750, ET-2751, ET-2756	102	102	102	102
L4160 Series	101	101	101	101
ET-2750U	120	120	120	120

For Australia and New Zealand

BK: Black	C: Cyan	M: Magenta	Y: Yellow
502	502	502	502

For Asia

BK: Black	C: Cyan	M: Magenta	Y: Yellow
001	001	001	001

Important:

Epson warranty does not cover damage caused by inks other than those specified, including any genuine Epson ink not designed for this printer or any third party ink.

Other products not manufactured by Epson may cause damage that is not covered by Epson's warranties, and under certain circumstances, may cause erratic printer behavior.

Note:

- Ink bottle codes may vary by location. For the correct codes in your area, contact Epson support.
- For users in Europe, visit the following website for information on Epson's ink bottle yields.
<http://www.epson.eu/pageyield>

Related Information

- ➔ [“Technical Support Web Site” on page 168](#)

Ink Bottle Handling Precautions

Read the following instructions before refilling ink.

Refilling Ink

Handling precautions

- ❑ Use ink bottles with the correct part code for this printer.
- ❑ This printer requires careful handling of ink. Ink may splatter when the ink tanks are filled or refilled with ink. If ink gets on your clothes or belongings, it may not come off.
- ❑ Do not shake too vigorously or squeeze the ink bottles.
- ❑ Once you open an ink bottle, we recommend using it as soon as possible.
- ❑ Store ink bottles at normal room temperature and keep them away from direct sunlight.
- ❑ Epson recommends using the ink bottle before the date printed on the package.
- ❑ Store the ink bottles in the same environment as the printer.
- ❑ When storing or transporting an ink bottle, do not tilt the bottle and do not subject it to impacts or temperature changes. Otherwise, ink may leak even if the cap on the ink bottle is tightened securely. Be sure to keep the ink bottle upright when tightening the cap, and take precautions to prevent ink from leaking when transporting the bottle, for example, putting the bottle in a bag.
- ❑ After bringing an ink bottle inside from a cold storage site, allow it to warm up at room temperature for at least three hours before using it.
- ❑ Do not open the ink bottle package until you are ready to fill the ink tank. The ink bottle is vacuum packed to maintain its reliability. If you leave an ink bottle unpacked for a long time before using it, normal printing may not be possible.
- ❑ Prolonged use of the printer when the ink level is below the lower line could damage the printer. Fill the ink tank to the upper line while the printer is not operating. To display the correct ink level estimates, reset the ink level after filling the tank.
- ❑ To ensure you receive premium print quality and to help protect your print head, a variable ink safety reserve remains in the ink tank when your printer indicates to refill ink. The yields quoted for you do not include this reserve.
- ❑ For optimum print results do not maintain low ink levels for extended periods of time.
- ❑ Although the ink bottles may contain recycled materials, this does not affect printer function or performance.
- ❑ Specifications and appearance of the ink bottle are subject to change without prior notice for improvement.
- ❑ Quoted yields may vary depending on the images that you are printing, the paper type that you are using, the frequency of your prints and environmental conditions such as temperature.

Ink consumption

- ❑ To maintain optimum print head performance, some ink is consumed from all ink tanks not only during printing but also during maintenance operation such as print head cleaning.
- ❑ When printing in monochrome or grayscale, color inks instead of black ink may be used depending on the paper type or print quality settings. This is because a mixture of color inks is used to create black.
- ❑ The ink in the ink bottles supplied with your printer is partly used during initial setup. In order to produce high quality printouts, the print head in your printer will be fully charged with ink. This one-off process consumes a quantity of ink and therefore these bottles may print fewer pages compared to subsequent ink bottles.

Refilling the Ink Tanks

1. Select **Maintenance** on the home screen.

To select an item, move the focus to the item using the ▲ ▼ ◀ ▶ buttons, and then press the OK button.

Refilling Ink

2. Select **Reset Ink Levels**.
3. Press the  button.
4. Open the scanner unit with the document cover closed.

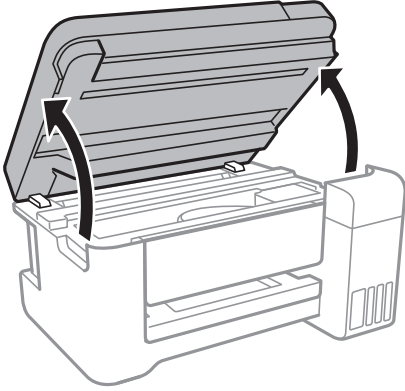

5. Open the ink tank cover.

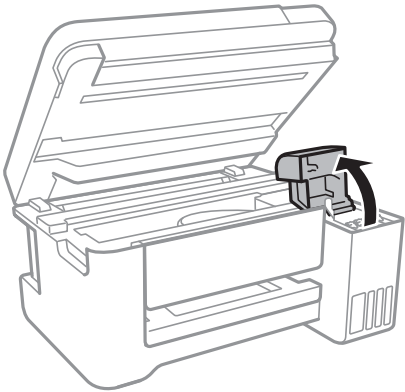

6. Open the cap of the ink tank.

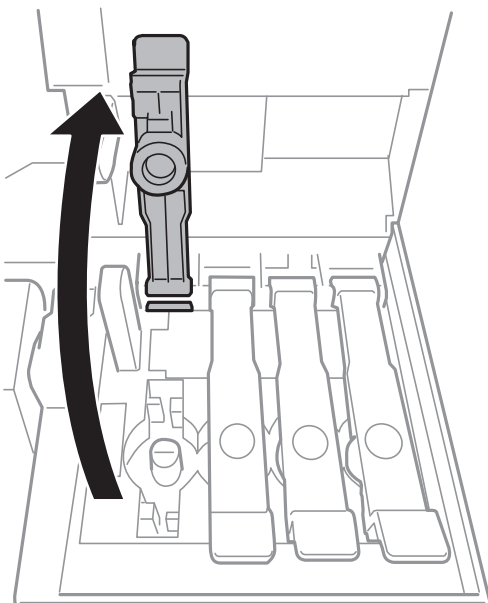

Refilling Ink

! **Important:**

Make sure that the color of the ink tank matches the ink color that you want to refill.

7. While holding the ink bottle upright, turn the cap slowly to remove it.

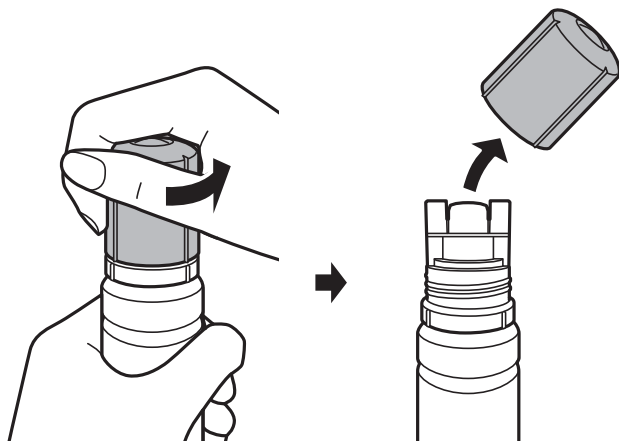

! **Important:**

- Be careful not to spill any ink.
- Do not touch the top of the ink bottle after removing the cap; otherwise you may be smeared with ink.

8. Position the top of the ink bottle along the slot in front of the filling port, and then stand the bottle slowly to insert it into the filling port.

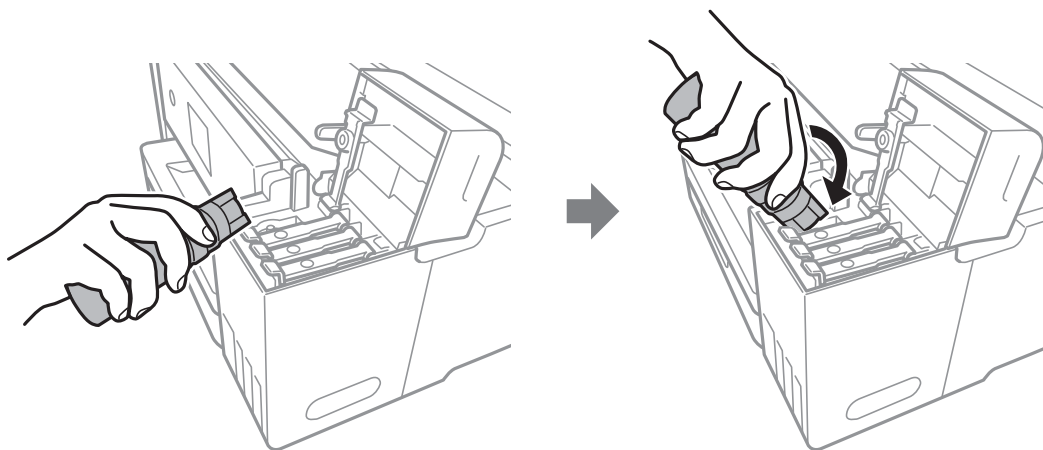

! **Important:**

Do not allow the top of the ink bottle to hit against any objects after removing its cap; otherwise ink may spill.

Refilling Ink

9. Insert the top of the ink bottle securely into the filling port of the tank to refill the tank with ink.
Ink pours into the tank just by holding the bottle normally without squeezing. The ink flow stops automatically when the ink is filled to the upper line.

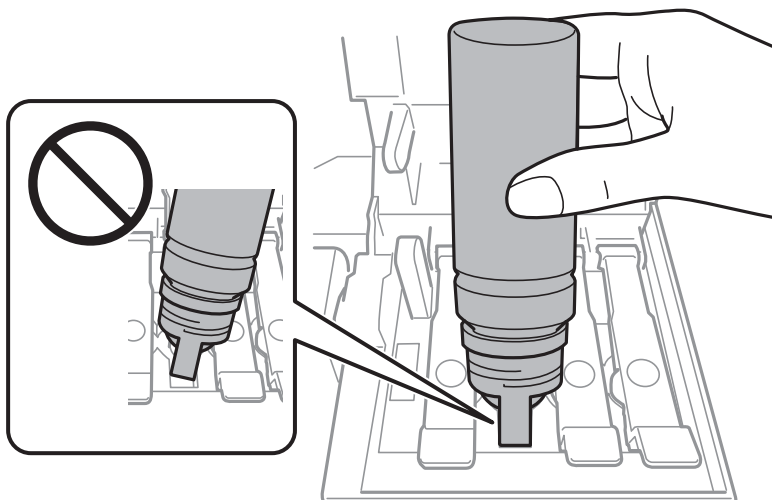

Note:

If the ink does not start flowing into the tank, remove the ink bottle and try reinserting it.

10. When you have finished refilling the ink, remove the ink bottle, and then close the cap of the ink tank securely.

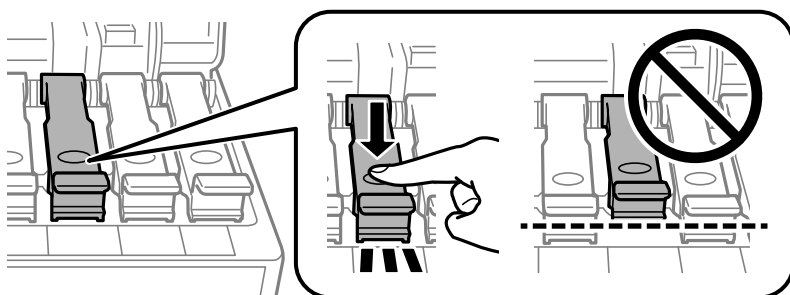

! Important:

Do not leave the ink bottle inserted; otherwise the bottle may be damaged or ink may leak.

Refilling Ink

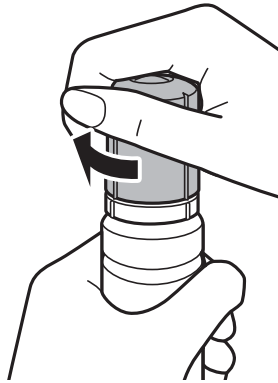

Note:

If any ink remains in the ink bottle, tighten the cap and store the bottle upright for later use.

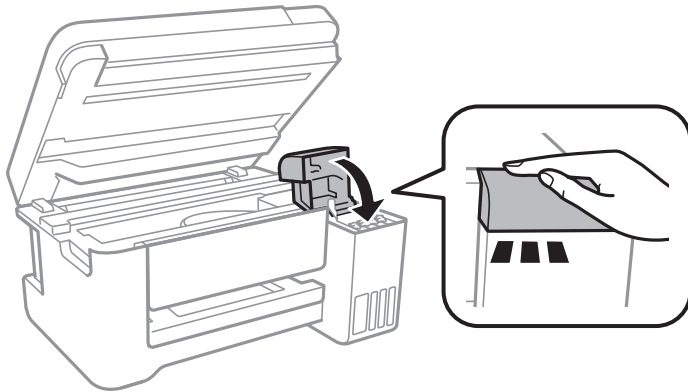

11. Close the ink tank cover firmly.



12. Close the scanner unit, and then press the  button.
13. Select the color of the ink you refilled up to the upper line.
14. Press the  button to reset the ink level.
15. Confirm the message, and then press the OK button.

**Important:**

If you continue to use the printer after resetting the ink level without refilling the ink tank to the upper line, printing may be performed without ink and this may damage the printer. Before you start printing, make sure you visually check the ink levels in all of the ink tanks.

Related Information

- ➔ [“Ink Bottle Codes” on page 101](#)
- ➔ [“Ink Bottle Handling Precautions” on page 101](#)
- ➔ [“Ink Spilled” on page 155](#)

Maintaining the Printer

Checking and Cleaning the Print Head

If the nozzles are clogged, the printouts become faint, there is visible banding, or unexpected colors appear. When print quality has declined, use the nozzle check feature and check if the nozzles are clogged. If the nozzles are clogged, clean the print head.

Important:

- Do not open the scanner unit or turn off the printer during head cleaning. If the head cleaning is incomplete, you may not be able to print.
- Because print head cleaning uses some ink, clean the print head only if quality declines.
- When ink is low, you may not be able to clean the print head.
- If print quality has not improved after repeating nozzle check and head cleaning three times, wait for at least 12 hours without printing, and then run the nozzle check again and repeat the head cleaning if necessary. We recommend to turn off the printer. If print quality has still not improved, run Power Cleaning. If it has still not improved, contact Epson support.
- To prevent the print head from drying out, do not unplug the printer while the power is on.

Checking and Cleaning the Print Head - Control Panel

1. Load A4-size plain paper in the printer.
2. Select **Maintenance** on the home screen.

To select an item, move the focus to the item using the ▲ ▼ ◀ ▶ buttons, and then press the OK button.

3. Select **Nozzle Check**.
4. Follow the on-screen instructions to print the nozzle check pattern.
5. Examine the printed pattern. If there are broken lines or missing segments as shown in the "NG" pattern, the print head nozzles may be clogged. Go to the next step. If you cannot see any broken lines or missing segments as in the following "OK" pattern, the nozzles are not clogged. Select **No** to close the nozzle check feature.

OK

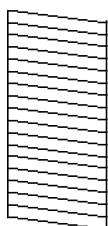

NG

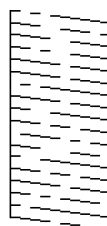

6. Select **Yes**, and then follow the on-screen instructions to clean the print head.

Maintaining the Printer

7. When cleaning is finished, print the nozzle check pattern again. Repeat cleaning and printing the pattern until all lines are printed completely.

Related Information

- ➔ [“Loading Paper in the Rear Paper Feed” on page 39](#)

Checking and Cleaning the Print Head - Windows

1. Load A4-size plain paper in the printer.
2. Access the printer driver window.
3. Click **Nozzle Check** on the **Maintenance** tab.
4. Follow the on-screen instructions.

Related Information

- ➔ [“Loading Paper in the Rear Paper Feed” on page 39](#)
- ➔ [“Accessing the Printer Driver” on page 54](#)

Checking and Cleaning the Print Head - Mac OS

1. Load A4-size plain paper in the printer.
2. Select **System Preferences** from the  menu > **Printers & Scanners** (or **Print & Scan**, **Print & Fax**), and then select the printer.
3. Click **Options & Supplies** > **Utility** > **Open Printer Utility**.
4. Click **Nozzle Check**.
5. Follow the on-screen instructions.

Related Information

- ➔ [“Loading Paper in the Rear Paper Feed” on page 39](#)

Running Power Cleaning

The **Power Cleaning** utility allows you to replace all of the ink inside the ink tubes. In the following situations, you may need to use this feature to improve the print quality.

- You printed or performed head cleaning when the ink levels were too low to be seen in the ink tank windows.
- You performed the nozzle check and head cleaning several times and then waited for at least 12 hours without printing, but print quality still did not improve.

Before running this feature, read the following instructions.

Maintaining the Printer

! **Important:**

Make sure that there is enough ink in the ink tanks.

Visually check all ink tanks are at least a third full. Low ink levels during Power Cleaning could damage the product.

! **Important:**

An interval of 12 hours is required between each Power Cleaning.

Normally, a single Power Cleaning should resolve the print quality issue within 12 hours. Therefore, to avoid unnecessary ink usage, you must wait 12 hours before you try it again.

! **Important:**



This feature effects the service life of the ink pads. The ink pads reach their capacity earlier by running this feature. If the ink pads have reached the end of their service life, contact Epson Support to request replacement.

Note:

When the ink levels are insufficient for Power Cleaning, you cannot run this feature. Even in this case, the levels for printing may remain.

Running Power Cleaning - Control Panel

Read the instructions for Power Cleaning before running this feature.

1. Turn off the printer, and then press the  button and  button at the same time to display the confirmation screen.
2. Follow the on-screen instructions to run the Power Cleaning feature.

Note:

If you cannot run this feature, solve the problems that are displayed on the screen. Next, follow this procedure from step 1 to run this feature again.

3. After running this feature, run the nozzle check to make sure the nozzles are not clogged.

Related Information

➔ [“Running Power Cleaning” on page 108](#)

Running Power Cleaning - Windows

1. Access the printer driver window.
2. Click **Power Cleaning** on the **Maintenance** tab.
3. Follow the on-screen instructions.

Note:

If you cannot run this feature, solve the problems that are displayed on the printer's control panel. Next, follow this procedure from step 1 to run this feature again.

Maintaining the Printer

Related Information

➔ [“Accessing the Printer Driver” on page 54](#)

Running Power Cleaning - Mac OS

1. Select **System Preferences** from the  menu > **Printers & Scanners** (or **Print & Scan**, **Print & Fax**), and then select the printer.
2. Click **Options & Supplies** > **Utility** > **Open Printer Utility**.
3. Click **Power Cleaning**.
4. Follow the on-screen instructions.

Note:

If you cannot run this feature, solve the problems that are displayed on the printer's control panel. Next, follow this procedure from step 1 to run this feature again.

Aligning the Print Head

If you notice a misalignment of vertical lines or blurred images, align the print head.

Aligning the Print Head - Control Panel

1. Load A4-size plain paper in the printer.
2. Select **Maintenance** on the home screen.
To select an item, move the focus to the item using the ▲ ▼ ◀ ▶ buttons, and then press the OK button.
3. Select **Print Head Alignment**.
4. Select **Vertical Alignment** or **Horizontal Alignment**, and then follow the on-screen instructions to print an alignment pattern.
 - Vertical Alignment:** Select this if your printouts look blurry or vertical ruled lines appear misaligned.
 - Horizontal Alignment:** Select this if you see horizontal banding at regular intervals.

Maintaining the Printer

5. Follow the on-screen instructions to align the print head.

- Vertical Alignment: Find and select the number for the most solid pattern in each group.

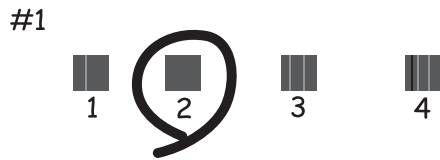

- Horizontal Alignment: Find and select the number for the least separated and overlapping pattern.

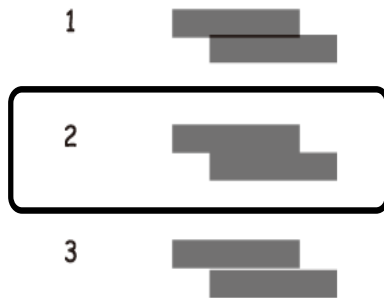

Related Information

➔ [“Loading Paper in the Rear Paper Feed” on page 39](#)

Cleaning the Paper Path

When the printouts are smeared or paper does not feed correctly, clean the roller inside.

! *Important:*

Do not use tissue paper to clean the inside of the printer. The print head nozzles may be clogged with lint.

Cleaning the Paper Path for Ink Smears

When the printouts are smeared or scuffed, clean the roller inside.

! *Important:*

Do not use tissue paper to clean the inside of the printer. The print head nozzles may be clogged with lint.

1. Load A4-size plain paper in the printer.

Maintaining the Printer

2. Select **Maintenance** on the home screen.

To select an item, move the focus to the item using the ▲ ▼ ◀ ▶ buttons, and then press the OK button.

3. Select **Paper Guide Cleaning**.
4. Follow the on-screen instructions to clean the paper path.

Note:

Repeat this procedure until the paper is not smeared with ink.

Related Information

➔ [“Loading Paper in the Rear Paper Feed” on page 39](#)

Cleaning the Scanner Glass

When the copies or scanned images are smeared, clean the scanner glass.



Important:

Never use alcohol or thinner to clean the printer. These chemicals can damage the printer.

1. Open the document cover.

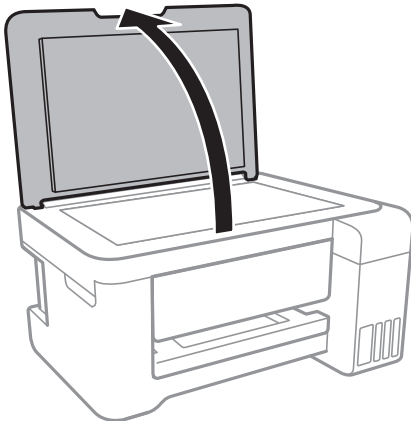

2. Use a soft, dry, clean cloth to clean the surface of the scanner glass.



Important:

- ❑ *If the glass surface is stained with grease or some other hard-to-remove material, use a small amount of glass cleaner and a soft cloth to remove it. Wipe off all remaining liquid.*
- ❑ *Do not press the glass surface too hard.*
- ❑ *Be careful not to scratch or damage the surface of the glass. A damaged glass surface can decrease the scan quality.*

Cleaning the Translucent Film

When the printout is not improved after aligning the print head or cleaning the paper path, the translucent film inside the printer may be smeared.

Items required:

- Cotton swabs (several)
- Water with a few drops of detergent (2 to 3 drops of detergent in 1/4 cup of tap water)
- Light for checking smears



Important:

Do not use cleaning liquid other than water with a few drops of detergent.

1. Turn off the printer by pressing the  button.
2. Open the scanner unit.

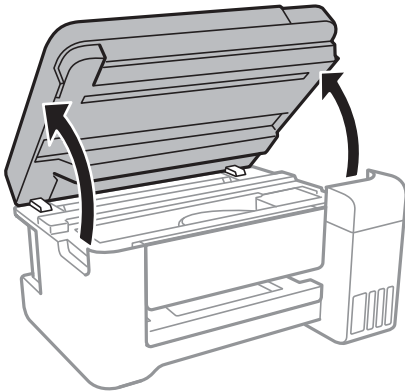

Maintaining the Printer

3. Check if the translucent film is smeared. Smears are easier to see if you use a light.
If there are smears (such as finger marks or grease) on the translucent film (A), go to the next step.

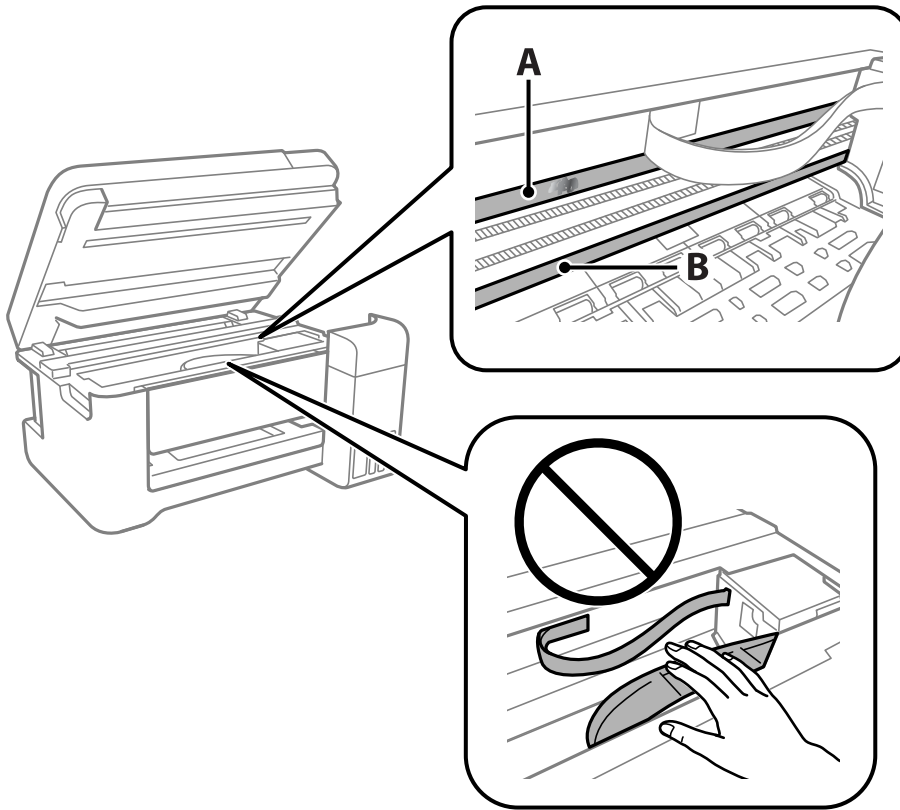

A: Translucent film

B: Rail

! *Important:*

Be careful not to touch the rail (B). Otherwise, you may not be able to print. Do not wipe off the grease on the rail, because this is necessary for operations.

4. Moisten a cotton swab with the water with a few drops of detergent so that it is not dripping water, and then wipe the smeared part.

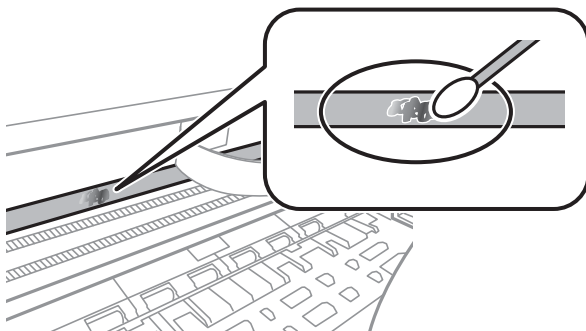

Maintaining the Printer

! **Important:**

Wipe off the smear gently. If you press the cotton swab too hard to the film, the springs of the film may be dislocated and the printer may be damaged.

5. Use a new dry cotton swab to wipe the film.

! **Important:**

Do not leave any fibers on the film.

Note:

To prevent the smear from spreading, frequently replace the cotton swab with a new one.

6. Repeat steps 4 and 5 until the film is not smeared.
7. Visually check that the film is not smeared.

Cleaning the Printer

If the printer's outer case is dirty or dusty, turn off the printer and clean it with a soft, clean, and moist cloth. If you cannot remove the dirt, try cleaning with a soft, clean, and moist cloth moistened with a mild detergent.

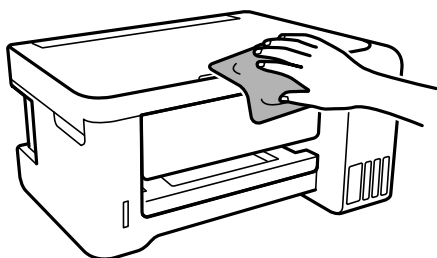

Maintaining the Printer

! Important:

- ❑ Be careful not to get water onto the printer mechanism or any electrical components. Otherwise, the printer could be damaged.
- ❑ Never use alcohol or paint thinner to clean the components and the case. These chemicals can damage them.
- ❑ Do not touch the white flat cable, translucent film, and ink tubes inside the printer. Doing so may cause a malfunction.

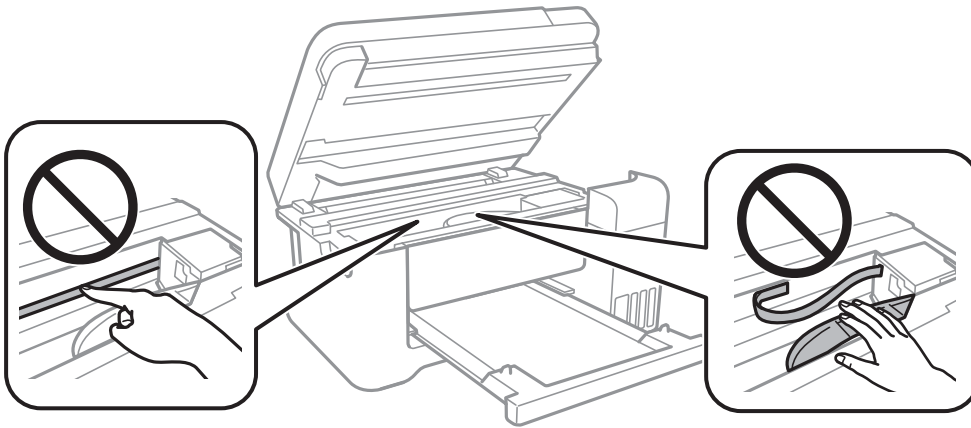

Checking the Total Number of Pages Fed Through the Printer

You can check the total number of pages fed through the printer.

Checking the Total Number of Pages Fed Through the Printer - Control Panel

The information is printed together with the nozzle check pattern.

1. Load A4-size plain paper in the printer.
2. Select **Maintenance** on the home screen.

To select an item, move the focus to the item using the ▲▼◀▶ buttons, and then press the OK button.

3. Select **Nozzle Check**.
4. Follow the on-screen instructions to print the nozzle check pattern.

Related Information

➔ [“Loading Paper in the Rear Paper Feed” on page 39](#)

Maintaining the Printer

Checking the Total Number of Pages Fed Through the Printer - Windows

1. Access the printer driver window.
2. Click **Printer and Option Information** on the **Maintenance** tab.

Related Information

➔ [“Accessing the Printer Driver” on page 54](#)

Checking the Total Number of Pages Fed Through the Printer - Mac OS

1. Select **System Preferences** from the  menu > **Printers & Scanners** (or **Print & Scan**, **Print & Fax**), and then select the printer.
2. Click **Options & Supplies** > **Utility** > **Open Printer Utility**.
3. Click **Printer and Option Information**.

Network Service and Software Information

This section introduces the network services and software products available for your printer from the Epson website.

Application for Configuring Printer Operations (Web Config)

Web Config is an application that runs in a web browser, such as Internet Explorer and Safari, on a computer or smart device. You can confirm the printer status or change the network service and printer settings. To use the Web Config, connect the printer and the computer or device to the same network.

The following browsers are supported.

OS	Browser
Windows XP SP3 or later	Internet Explorer 8 or later, Firefox*, Chrome*
Mac OS X v10.6.8 or later	Safari*, Firefox*, Chrome*
iOS*	Safari*
Android 2.3 or later	Default browser
Chrome OS*	Default browser

* Use the latest version.

Running Web Config on a Web Browser

1. Check the printer's IP address.

Select **Settings** > **Network Settings** > **Print Status Sheet** from the control panel, and then press the  button or the OK button. Check the printer's IP address on the printed status sheet.

2. Launch a Web browser from a computer or smart device, and then enter the printer's IP address.

Format:

IPv4: http://the printer's IP address/

IPv6: http://[the printer's IP address]/

Examples:

IPv4: http://192.168.100.201/

IPv6: http://[2001:db8::1000:1]/

Note:

Using the smart device, you can also run Web Config from the maintenance screen of Epson iPrint.

Related Information

➔ [“Using Epson iPrint” on page 82](#)

Running Web Config on Windows

When connecting a computer to the printer using WSD, follow the steps below to run Web Config.

1. Access the devices and printers screen in Windows.
 - ❑ Windows 10/Windows Server 2016
Right-click the start button or press and hold it, and then select **Control Panel > View devices and printers in Hardware and Sound**.
 - ❑ Windows 8.1/Windows 8/Windows Server 2012 R2/Windows Server 2012
Select **Desktop > Settings > Control Panel > View devices and printers in Hardware and Sound (or Hardware)**.
 - ❑ Windows 7/Windows Server 2008 R2
Click the start button, and select **Control Panel > View devices and printers in Hardware and Sound**.
 - ❑ Windows Vista/Windows Server 2008
Click the start button, and select **Control Panel > Printers in Hardware and Sound**.
2. Right-click on your printer and select **Properties**.
3. Select the **Web Service** tab and click the URL.

Running Web Config on Mac OS

1. Select **System Preferences** from the  menu > **Printers & Scanners** (or **Print & Scan, Print & Fax**), and then select the printer.
2. Click **Options & Supplies > Show Printer Webpage**.

Application for Scanning Documents and Images (Epson Scan 2)

Epson Scan 2 is an application for controlling scanning. You can adjust the size, resolution, brightness, contrast, and quality of the scanned image. You can also start Epson Scan 2 from a TWAIN-compliant scanning application. See the application's help for details.

Starting on Windows

Note:

For Windows Server operating systems, make sure the **Desktop Experience** feature is installed.

- ❑ Windows 10/Windows Server 2016
Click the start button, and then select **EPSON > Epson Scan 2**.

Network Service and Software Information

- ❑ Windows 8.1/Windows 8/Windows Server 2012 R2/Windows Server 2012
Enter the application name in the search charm, and then select the displayed icon.
- ❑ Windows 7/Windows Vista/Windows XP/Windows Server 2008 R2/Windows Server 2008/Windows Server 2003 R2/Windows Server 2003
Click the start button, and then select **All Programs** or **Programs > EPSON > Epson Scan 2 > Epson Scan 2**.

Starting on Mac OS

Note:

Epson Scan 2 does not support the Mac OS fast user switching feature. Turn off fast user switching.

Select **Go > Applications > Epson Software > Epson Scan 2**.

Related Information

- ➔ [“Scanning Using Epson Scan 2” on page 95](#)
- ➔ [“Installing the Latest Applications” on page 123](#)

Adding the Network Scanner

Before using Epson Scan 2, you need to add the network scanner.

1. Start the software, and then click **Add** on the **Scanner Settings** screen.

Note:

- ❑ If **Add** is grayed out, click **Enable Editing**.
- ❑ If the main screen of Epson Scan 2 is displayed, it has already been connected to the scanner. If you want to connect to another network, select **Scanner > Settings** to open the **Scanner Settings** screen.

2. Add the network scanner. Enter the following items, and then click **Add**.

- ❑ **Model:** Select the scanner you want to connect to.
- ❑ **Name:** Enter the scanner name within 32 characters.
- ❑ **Search for Network:** When the computer and the scanner are on the same network, the IP address is displayed. If it is not displayed, click the  button. If the IP address is still not displayed, click **Enter address**, and then enter the IP address directly.

3. Select the scanner on the **Scanner Settings** screen, and then click **OK**.

Application for Configuring Scanning Operations from the Control Panel (Epson Event Manager)

Epson Event Manager is an application that allows you to manage scanning from the control panel and save images to a computer. You can add your own settings as presets, such as the document type, the save folder location, and the image format. See the application's help for details.

Note:

Windows Server operating systems are not supported.

Network Service and Software Information

Starting on Windows

Windows 10

Click the start button, and then select **Epson Software > Event Manager**.

Windows 8.1/Windows 8

Enter the application name in the search charm, and then select the displayed icon.

Windows 7/Windows Vista/Windows XP

Click the start button, and then select **All Programs** or **Programs > Epson Software > Event Manager**.

Starting on Mac OS

Go > Applications > Epson Software > Event Manager.

Related Information

➔ [“Installing the Latest Applications” on page 123](#)

Application for Laying Out Photos (Epson Easy Photo Print)

Epson Easy Photo Print is an application that allows you to easily print photos with various layouts. You can preview the photo image and adjust the images or position. You can also print photos with a frame. See the application's help for details.

By printing on genuine Epson photo paper, the ink quality is maximized and the printouts are vivid and clear.

To perform borderless printing using a commercially available application, make the following settings.

- Create image data to fit the paper size. If a margin setting is available in the application you are using, set the margin to 0 mm.
- Enable the borderless printing setting in the printer driver.

Note:

- Windows Server operating systems are not supported.*
- To use this application, the printer driver needs to be installed.*

Starting on Windows

Windows 10

Click the start button, and then select **Epson Software > Epson Easy Photo Print**.

Windows 8.1/Windows 8

Enter the application name in the search charm, and then select the displayed icon.

Windows 7/Windows Vista/Windows XP

Click the start button, and then select **All Programs** or **Programs > Epson Software > Epson Easy Photo Print**.

Starting on Mac OS

Go > Applications > Epson Software > Epson Easy Photo Print.

Related Information

➔ [“Installing the Latest Applications” on page 123](#)

Application for Printing Web Pages (E-Web Print)

E-Web Print is an application that allows you to easily print web pages with various layouts. See the application's help for details. You can access the help from the **E-Web Print** menu on the **E-Web Print** tool bar.

Note:

- Windows Server operating systems are not supported.*
- Check for supported browsers and the latest version from the download site.*

Starting

When you install E-Web Print, it is displayed in your browser. Click **Print** or **Clip**.

Related Information

➔ [“Installing the Latest Applications” on page 123](#)

Application for Updating Software and Firmware (EPSON Software Updater)

EPSON Software Updater is an application that installs new software, and updates firmware and manuals over the Internet. If you want to check for update information regularly, you can set the interval for checking for updates in EPSON Software Updater's Auto Update Settings.

Note:

Windows Server operating systems are not supported.

Starting on Windows

- Windows 10
 - Click the start button, and then select **Epson Software > EPSON Software Updater**.
- Windows 8.1/Windows 8
 - Enter the application name in the search charm, and then select the displayed icon.
- Windows 7/Windows Vista/Windows XP
 - Click the start button, and then select **All Programs (or Programs) > Epson Software > EPSON Software Updater**.

Note:

*You can also start EPSON Software Updater by clicking the printer icon on the task bar on the desktop, and then selecting **Software Update**.*

Starting on Mac OS

Select **Go > Applications > Epson Software > EPSON Software Updater**.

Related Information

➔ [“Installing the Latest Applications” on page 123](#)

Installing the Latest Applications

Note:

When reinstalling an application, you need to uninstall it first.

1. Make sure the printer and the computer are available for communication, and the printer is connected to the Internet.
2. Start EPSON Software Updater.

The screenshot is an example on Windows.

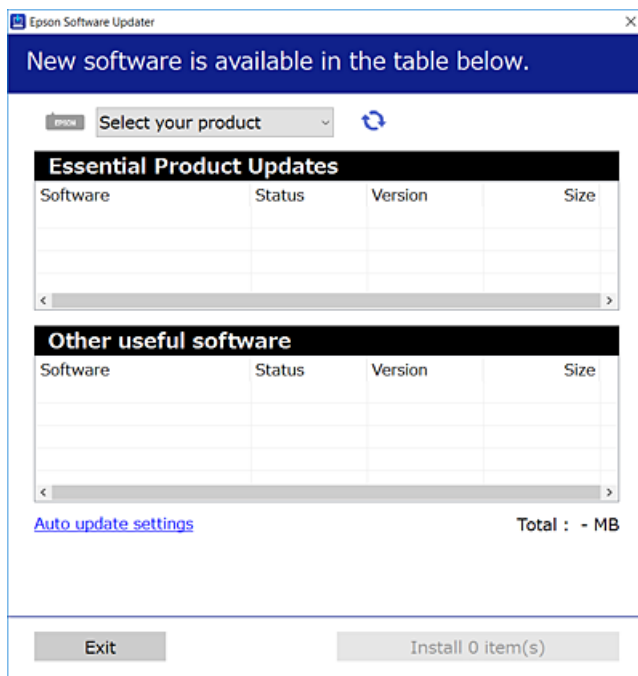

3. For Windows, select your printer, and then click  to check for the latest available applications.
4. Select the items you want to install or update, and then click the install button.

**Important:**

Do not turn off or unplug the printer until the update is complete; otherwise, the printer may malfunction.

Note:

- ❑ You can download the latest applications from the Epson website.

<http://www.epson.com>

- ❑ If you use Windows Server operating systems, you cannot use EPSON Software Updater. Download the latest applications from the Epson website.

Related Information

- ➔ “Application for Updating Software and Firmware (EPSON Software Updater)” on page 122
- ➔ “Uninstalling Applications” on page 124

Updating the Printer's Firmware using the Control Panel

If the printer is connected to the Internet, you can update the printer's firmware using the control panel. You can also set the printer to regularly check for firmware updates and notify you if any are available.

1. Select **Settings** on the home screen.

To select an item, move the focus to the item using the ▲ ▼ ◀ ▶ buttons, and then press the OK button.

2. Select **Firmware Update > Update**.

Note:

Enable **Notification** to set the printer to regularly check for available firmware updates.

3. Check the message displayed on the screen and press the OK button to start searching for available updates.
4. If a message is displayed on the LCD screen informing you that a firmware update is available, follow the on-screen instructions to start the update.

**Important:**

- Do not turn off or unplug the printer until the update is complete; otherwise, the printer may malfunction.
- If the firmware update is not completed or is unsuccessful, the printer does not start up normally and "Recovery Mode" is displayed on the LCD screen the next time the printer is turned on. In this situation, you need to update the firmware again using a computer. Connect the printer to the computer with a USB cable. While "Recovery Mode" is displayed on the printer, you cannot update the firmware over a network connection. On the computer, access your local Epson website, and then download the latest printer firmware. See the instructions on the website for the next steps.

Uninstalling Applications

Log in to your computer as an administrator. Enter the administrator password if the computer prompts you.

Uninstalling Applications - Windows

1. Press the  button to turn off the printer.
2. Quit all running applications.
3. Open **Control Panel**:

- Windows 10/Windows Server 2016

Right-click the start button or press and hold it, and then select **Control Panel**.

Network Service and Software Information

- Windows 8.1/Windows 8/Windows Server 2012 R2/Windows Server 2012

Select **Desktop > Settings > Control Panel**.

- Windows 7/Windows Vista/Windows XP/Windows Server 2008 R2/Windows Server 2008/Windows Server 2003 R2/Windows Server 2003

Click the start button and select **Control Panel**.

4. Open **Uninstall a program** (or **Add or Remove Programs**):

- Windows 10/Windows 8.1/Windows 8/Windows 7/Windows Vista/Windows Server 2016/Windows Server 2012 R2/Windows Server 2012/Windows Server 2008 R2/Windows Server 2008

Select **Uninstall a program** in **Programs**.

- Windows XP/Windows Server 2003 R2/Windows Server 2003

Click **Add or Remove Programs**.

5. Select the application you want to uninstall.

You cannot uninstall the printer driver if there is any print jobs. Delete or wait to be printed the jobs before uninstalling.

6. Uninstall the applications:

- Windows 10/Windows 8.1/Windows 8/Windows 7/Windows Vista/Windows Server 2016/Windows Server 2012 R2/Windows Server 2012/Windows Server 2008 R2/Windows Server 2008

Click **Uninstall/Change** or **Uninstall**.

- Windows XP/Windows Server 2003 R2/Windows Server 2003

Click **Change/Remove** or **Remove**.

Note:

*If the **User Account Control** window is displayed, click **Continue**.*

7. Follow the on-screen instructions.

Uninstalling Applications - Mac OS

1. Download the Uninstaller using EPSON Software Updater.

Once you have downloaded the Uninstaller, you do not need to download it again each time you uninstall the application.

2. Press the button to turn off the printer.

3. To uninstall the printer driver, select **System Preferences** from the menu > **Printers & Scanners** (or **Print & Scan, Print & Fax**), and then remove the printer from the enabled printers list.

4. Quit all running applications.

5. Select **Go > Applications > Epson Software > Uninstaller**.

Network Service and Software Information

6. Select the application you want to uninstall, and then click **Uninstall**.

**Important:**

The Uninstaller removes all drivers for Epson inkjet printers on the computer. If you use multiple Epson inkjet printers and you only want to delete some drivers, delete all of them first, and then install the necessary printer driver again.

Note:

*If you cannot find the application you want to uninstall in the application list, you cannot uninstall using the Uninstaller. In this situation, select **Go > Applications > Epson Software**, select the application you want to uninstall, and then drag it to the trash icon.*

Related Information

- ➔ [“Application for Updating Software and Firmware \(EPSON Software Updater\)” on page 122](#)

Printing Using a Network Service

By using Epson Connect service available on the Internet, you can print from your smartphone, tablet PC, or laptop, anytime and practically anywhere. To use this service, you need to register the user and the printer in Epson Connect.

The features available on the Internet are as follows.

 Email Print

When you send an email with attachments such as documents or images to an email address assigned to the printer, you can print that email and the attachments from remote locations such as your home or office printer.

 Epson iPrint

This Application is for iOS and Android, and allows you to print from a smart phone or tablet. You can print documents, images, and websites by sending them directly to a printer on the same wireless LAN.

 Remote Print Driver

This is a shared driver supported by Remote Print Driver. When printing using a printer in a remote location, you can print by changing the printer on the usual applications window.

See the Epson Connect portal website for details.

<https://www.epsonconnect.com/>

<http://www.epsonconnect.eu> (Europe only)

Solving Problems

Checking the Printer Status

Checking Error Codes on the LCD Screen

A code is displayed on the LCD screen if there is an error or information that requires your attention.

Code	Situation	Solutions
E-01	A printer error has occurred.	Open the scanner unit and remove any paper or protective material inside the printer. Turn the power off and on again.
E-02	A scanner error has occurred.	Turn the power off and on again.
E-11	An ink pad needs to be replaced.	Contact Epson or an authorised Epson service provider to replace the ink pad*. It is not a user-serviceable part. However, non-printing features such as scanning are available.
W-01	A paper jam has occurred.	Remove the paper from the printer and press the button displayed on the bottom of the LCD screen to clear the error. In some cases, you need to turn the power off and on again.
W-11	An ink pad is nearing the end of its service life.	Contact Epson or an authorised Epson service provider to replace the ink pad*. It is not a user-serviceable part. The message will be displayed until the ink pad is replaced. Press the OK button to resume printing.
I-22	Set Wi-Fi from the Push Button (WPS) .	Push the access point button. If there is no button on the access point, open the access point setting window, and then click the button displayed in the software.
I-23	Set Wi-Fi from the PIN Code (WPS) .	Enter the PIN code displayed on the LCD screen into the access point or computer within two minutes.
I-31	Set Wi-Fi from the Wi-Fi Auto Connect .	Install the software on your computer, and then press the OK button when Wi-Fi setup starts.
I-41	Paper Setup Auto Display is disabled. Some functions cannot be used.	If Paper Setup Auto Display is disabled, you cannot use AirPrint. To use AirPrint, enable Paper Setup Auto Display .
I-60	Your computer may not support WSD (Web Services for Devices).	The scan to computer (WSD) feature is only available for computers running English versions of Windows 10, Windows 8.1, Windows 8, Windows 7 or Windows Vista. Make sure that the printer is correctly connected to the computer.
Recovery Mode	The printer has started in recovery mode because the firmware update failed.	Follow the steps below to try to update the firmware again. 1. Connect the computer and the printer with a USB cable. (During recovery mode, you cannot update the firmware over a network connection.) 2. Visit your local Epson website for further instructions.

Solving Problems

* In some print cycles a very small amount of surplus ink may be collected in the ink pad. To prevent ink leakage from the pad, the printer is designed to stop printing when the pad has reached its limit. Whether and how often this is required will vary according to the number of pages you print, the type of material that you print and the number of cleaning cycles that the printer performs. The need for replacement of the pad does not mean that your printer has ceased to operate in accordance with its specifications. The printer will advise you when the pad requires replacing and this can only be performed by an authorised Epson Service provider. The Epson warranty does not cover the cost of this replacement.

Related Information

- ➔ [“Contacting Epson Support” on page 168](#)
- ➔ [“Installing the Latest Applications” on page 123](#)
- ➔ [“Uninstalling Applications” on page 124](#)
- ➔ [“Updating the Printer's Firmware using the Control Panel” on page 124](#)

Checking the Printer Status - Windows

1. Access the printer driver window.
2. Click **EPSON Status Monitor 3** on the **Maintenance** tab.

Note:

- You can also check the printer status by double-clicking the printer icon on the taskbar. If the printer icon is not added to the taskbar, click **Monitoring Preferences** on the **Maintenance** tab, and then select **Register the shortcut icon to the taskbar**.
- If **EPSON Status Monitor 3** is disabled, click **Extended Settings** on the **Maintenance** tab, and then select **Enable EPSON Status Monitor 3**.

Related Information

- ➔ [“Accessing the Printer Driver” on page 54](#)

Checking the Printer Status - Mac OS

1. Select **System Preferences** from the  menu > **Printers & Scanners** (or **Print & Scan**, **Print & Fax**), and then select the printer.
2. Click **Options & Supplies** > **Utility** > **Open Printer Utility**.
3. Click **EPSON Status Monitor**.

You can check the printer status, ink levels, and error status.

Checking the Software Status

You may be able to clear the problem by updating the software to the latest version. To check the software status, use the software update tool.

Related Information

- ➔ [“Application for Updating Software and Firmware \(EPSON Software Updater\)” on page 122](#)
- ➔ [“Installing the Latest Applications” on page 123](#)

Removing Jammed Paper

Check the error displayed on the control panel and follow the instructions to remove the jammed paper including any torn pieces. Next, clear the error.

**Important:**

- Remove the jammed paper carefully. Removing the paper vigorously may cause damage to the printer.
- When removing jammed paper, avoid tilting the printer, placing it vertically, or turning it upside down; otherwise ink may leak.

Removing Jammed Paper from the Rear Paper Feed

Remove the jammed paper.

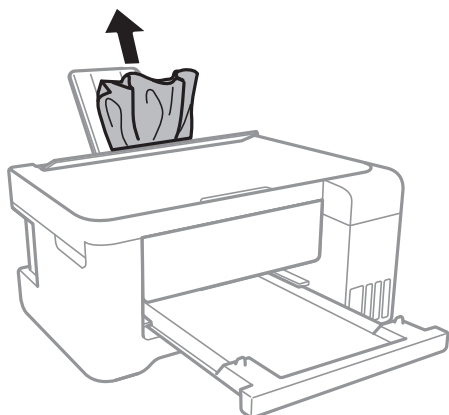

Removing Jammed Paper from Inside the Printer

**Caution:**

- Be careful not to trap your hand or fingers when opening or closing the scanner unit. Otherwise you may be injured.
- Never touch the buttons on the control panel while your hand is inside the printer. If the printer starts operating, it could cause an injury. Be careful not to touch the protruding parts to avoid injury.

Solving Problems

1. Open the scanner unit with the document cover closed.

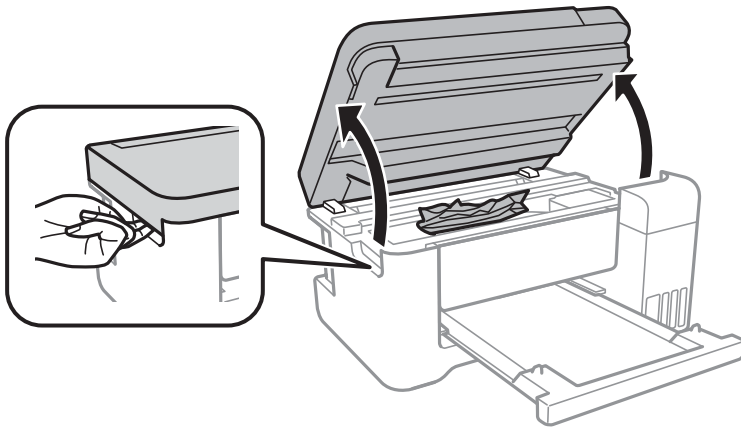

2. Remove the jammed paper.

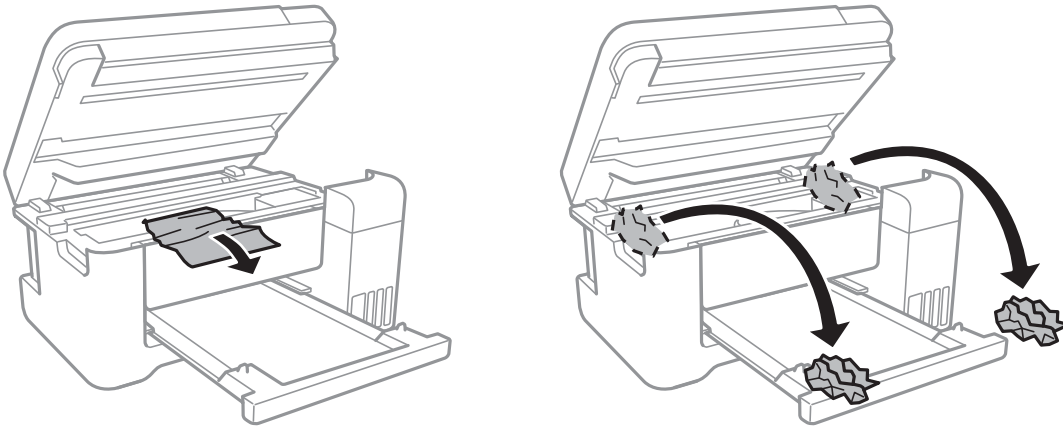

! **Important:**

Do not touch the white flat cable, translucent film, and ink tubes inside the printer. Doing so may cause a malfunction.

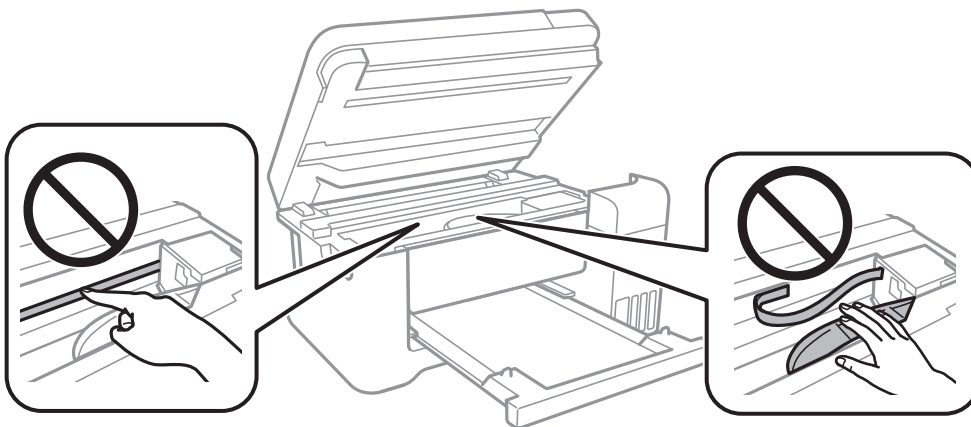

Solving Problems

3. Close the scanner unit.

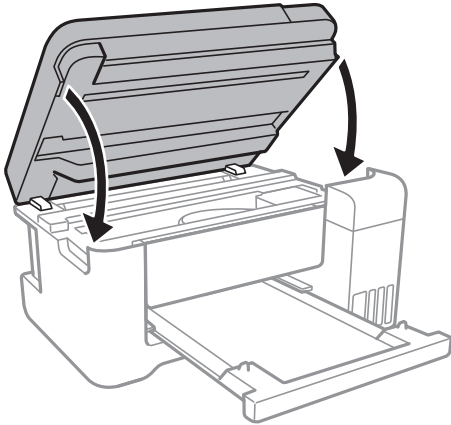

Removing Jammed Paper from Rear Cover

1. Remove the rear cover.

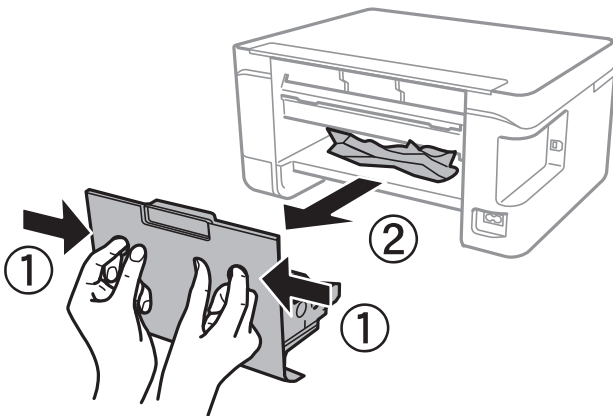

2. Remove the jammed paper.

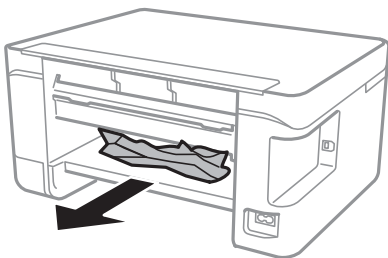

Solving Problems

3. Remove jammed paper from the rear cover.

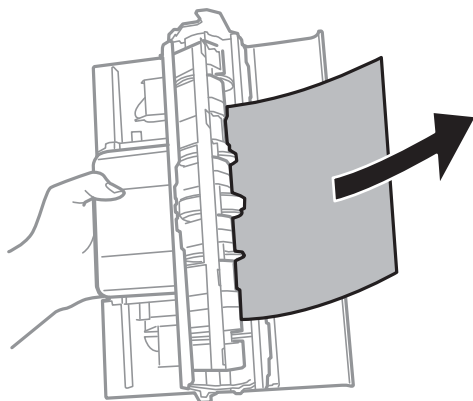

4. Insert the rear cover in the printer.

Paper Does Not Feed Correctly

Check the following points, and then take the appropriate actions to solve the problem.

- Place the printer on a flat surface and operate in the recommended environmental conditions.
- Use paper supported by this printer.
- Follow the paper handling precautions.
- Do not load more than the maximum number of sheets specified for the paper. For plain paper, do not load above the line indicated by the triangle symbol on the edge guide.
- Make sure the paper size and paper type settings match the actual paper size and paper type loaded in the printer.
- Do not place objects on the feeder guard.

Related Information

- ➔ [“Environmental Specifications” on page 161](#)
- ➔ [“Paper Handling Precautions” on page 38](#)
- ➔ [“Available Paper and Capacities” on page 37](#)
- ➔ [“List of Paper Type” on page 42](#)

Paper Jams

- Load paper in the correct direction, and slide the edge guides against the edges of the paper.
- Load one sheet of paper at a time if you have loaded several sheets of paper.

Related Information

- ➔ [“Removing Jammed Paper” on page 129](#)
- ➔ [“Loading Paper in the Rear Paper Feed” on page 39](#)

Paper Feeds at a Slant

Load paper in the correct direction, and slide the edge guides against the edges of the paper.

Related Information

➔ [“Loading Paper in the Rear Paper Feed” on page 39](#)

Several Sheets of Paper are Fed at a Time

- Load one sheet of paper at a time.
- When several sheets of paper are fed at a time during manual 2-sided printing, remove any paper which is loaded in the printer before you reload the paper.

Paper Out Error Occurs

When a paper out error occurs although paper is loaded in the rear paper feed, reload paper in the center of the rear paper feed.

Paper is Ejected During Printing



When you load letterhead paper (paper on which information such as the sender's name or corporation name are pre-printed in the header), select **Letterhead** as the paper type setting.

Power and Control Panel Problems

Power Does Not Turn On

- Make sure the power cord is securely plugged in.
- Hold down the  button for a little longer.

Power Does Not Turn Off

Hold down the  button for a little longer. If you still cannot turn off the printer, unplug the power cord. To prevent the print head from drying out, turn the printer back on and turn it off by pressing the  button.

Power Turns Off Automatically

- Select **Power Off Settings** in **Settings**, and then disable the **Power Off If Inactive** and **Power Off If Disconnected** settings.
- Disable the **Power Off Timer** setting in **Settings**.

Solving Problems

Note:

Your product may have the **Power Off Settings** or **Power Off Timer** feature depending on the location of purchase.

LCD Screen Gets Dark

The printer is in sleep mode. Press any button on the control panel to return the LCD screen to its former state.

Cannot Print from a Computer

Checking the Connection (USB)

- ❑ Connect the USB cable securely to the printer and the computer.
- ❑ If you are using a USB hub, try to connect the printer directly to the computer.
- ❑ If the USB cable cannot be recognized, change the port, or change the USB cable.
- ❑ If the printer cannot print using a USB connection, try the following.

Disconnect the USB cable from the computer. Right-click on the printer icon displayed on the computer, and then select **Remove Device**. Next, connect the USB cable to the computer and try a test print.

Re-set the USB connection by following the steps in this manual for changing the connection method to a computer. See the related information link below for details.

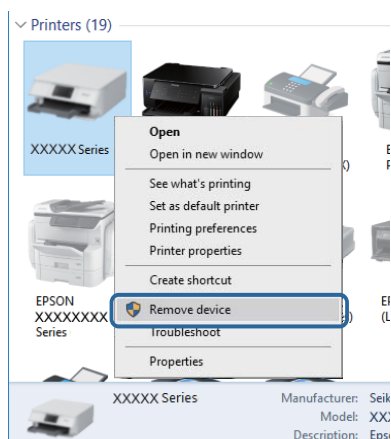

Related Information

- ➔ [“Changing the Connection Method to a Computer” on page 34](#)

Checking the Connection (Network)

- ❑ When you have changed your access point or provider, try making network settings for the printer again. Connect the computer or smart device to the same SSID as the printer.
- ❑ Turn off the devices you want to connect to the network. Wait for about 10 seconds, and then turn on the devices in the following order; access point, computer or smart device, and then printer. Move the printer and computer or smart device closer to the access point to help with radio wave communication, and then try to make network settings again.

Solving Problems

- ❑ Print the network connection report. See the related information link below for details. If the report shows that the network connection failed, check the network connection report and then follow the printed solutions.
- ❑ If the IP address assigned to the printer is 169.254.XXX.XXX, and the subnet mask is 255.255.0.0, the IP address may not be assigned correctly. Restart the access point or reset the network settings for the printer. If this does not solve the problem, see the documentation for the access point.
- ❑ Try accessing any website from your computer to make sure that your computer's network settings are correct. If you cannot access any website, there is a problem on the computer. Check the network connection of the computer.

Related Information

- ➔ [“Connecting to a Computer” on page 22](#)
- ➔ [“Printing a Network Connection Report” on page 27](#)

Checking the Software and Data

- ❑ Make sure that a genuine Epson printer driver is installed. If a genuine Epson printer driver is not installed, the available functions are limited. We recommend using a genuine Epson printer driver. See the related information link below for details.
- ❑ If you are printing a large data size image, the computer may run out of memory. Print the image at a lower resolution or a smaller size.

Related Information

- ➔ [“Checking for Genuine Epson Printer Drivers” on page 135](#)
- ➔ [“Installing the Latest Applications” on page 123](#)

Checking for Genuine Epson Printer Drivers

You can check if a genuine Epson printer driver is installed on your computer by using one of the following methods.

Windows

Select **Control Panel > View devices and printers (Printers, Printers and Faxes)**, and then do the following to open the print server properties window.

- ❑ Windows 10/Windows 8.1/Windows 8/Windows 7/Windows Server 2016/Windows Server 2012 R2/Windows Server 2012/Windows Server 2008 R2
Click the printer icon, and then click **Print server properties** at the top of the window.
- ❑ Windows Vista/Windows Server 2008
Right-click on the **Printers** folder, and then click **Run as administrator > Server Properties**.
- ❑ Windows XP/Windows Server 2003 R2/Windows Server 2003
From the **File** menu, select **Server Properties**.

Solving Problems

Click the **Driver** tab. If your printer name is displayed in the list, a genuine Epson printer driver is installed on your computer.

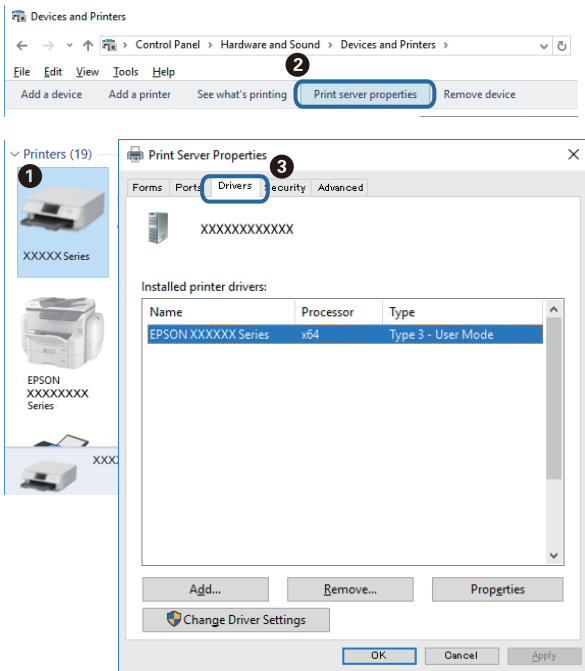

Mac OS

Select **System Preferences** from the  menu > **Printers & Scanners** (or **Print & Scan**, **Print & Fax**), and then select the printer. Click **Options & Supplies**, and if the **Options** tab and **Utility** tab are displayed on the window, a genuine Epson printer driver is installed on your computer.



Related Information

➔ [“Installing the Latest Applications” on page 123](#)

Solving Problems

Checking the Printer Status from the Computer (Windows)

Click **Print Queue** on the printer driver's **Maintenance** tab, and then check the following.

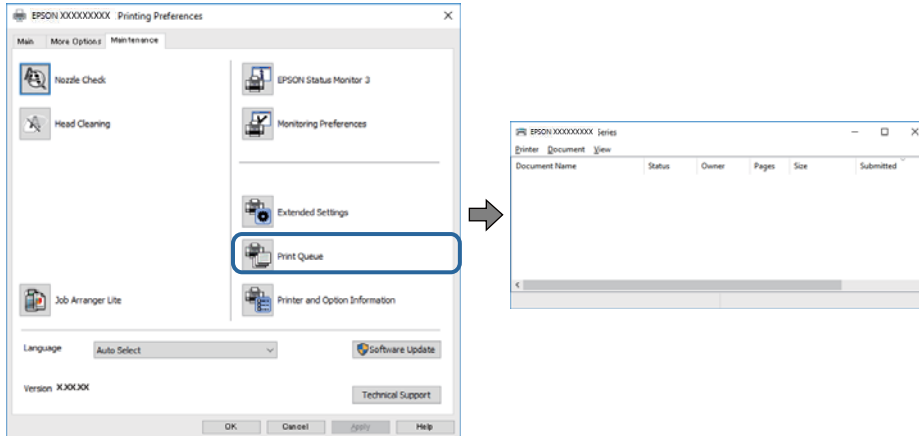

- Check if there are any paused print jobs.

If unnecessary data remains, select **Cancel all documents** from the **Printer** menu.

- Make sure the printer is not offline or pending.

If the printer is offline or pending, clear the offline or pending setting from the **Printer** menu.

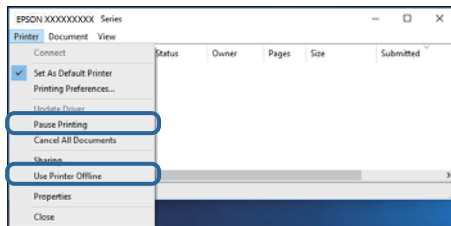

- Make sure the printer is selected as the default printer from the **Printer** menu (there should be a check mark on the menu item).

If the printer is not selected as the default printer, set it as the default printer. If there are multiple icons in **Control Panel > View devices and printers (Printers, Printers and Faxes)**, see the following to select the icon.

Example)

USB connection: EPSON XXXX Series

Network connection: EPSON XXXX Series (network)

If you install the printer driver multiple times, copies of printer driver may be created. If copies such as "EPSON XXXX Series (copy 1)" are created, right-click the copied driver icon, and then click **Remove Device**.

- Make sure the printer port is selected correctly in **Property > Port** from the **Printer** menu as follows.

Select "**USBXXX**" for a USB connection, or "**EpsonNet Print Port**" for a network connection.

Checking the printer status from the computer (Mac OS)

Make sure the printer status is not **Pause**.

Select **System Preferences** from the  menu > **Printers & Scanners** (or **Print & Scan, Print & Fax**), and then double-click the printer. If the printer is paused, click **Resume** (or **Resume Printer**).

When You Cannot Make Network Settings

- ❑ Turn off the devices you want to connect to the network. Wait for about 10 seconds, and then turn on the devices in the following order; access point, computer or smart device, and then printer. Move the printer and computer or smart device closer to the access point to help with radio wave communication, and then try to make network settings again.
- ❑ Select **Settings > Network Settings > Connection Check**, and then print the network connection report. If an error has occurred, check the network connection report and then follow the printed solutions.

Related Information

- ➔ [“Printing a Network Connection Report” on page 27](#)
- ➔ [“Messages and Solutions on the Network Connection Report” on page 28](#)

Cannot Connect from Devices Even Though Network Settings are No Problems

If you cannot connect from the computer or smart device to the printer even though the network connection report does not show any problems, see the following.

- ❑ When you are using multiple access points at the same time, you may not be able to use the printer from the computer or smart device depending on the settings of the access points. Connect the computer or smart device to the same access point as the printer.

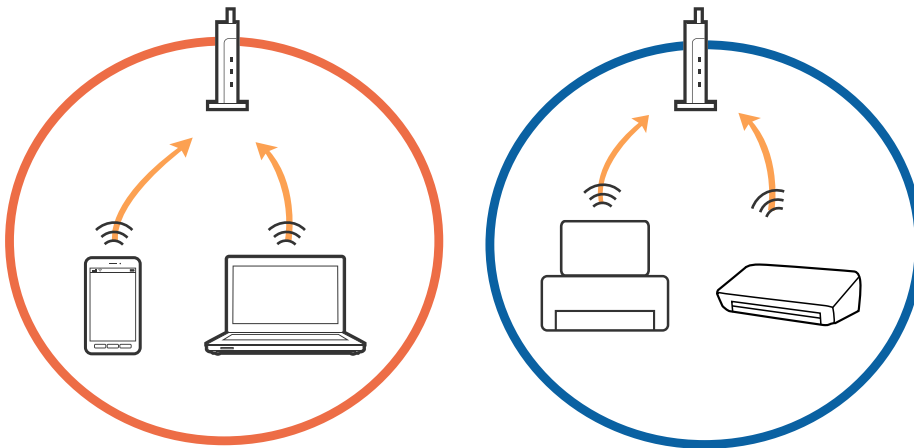

Solving Problems

- ❑ You may not be able to connect to the access point when the access point has multiple SSIDs and devices are connected to different SSIDs on the same access point. Connect the computer or smart device to the same SSID as the printer.

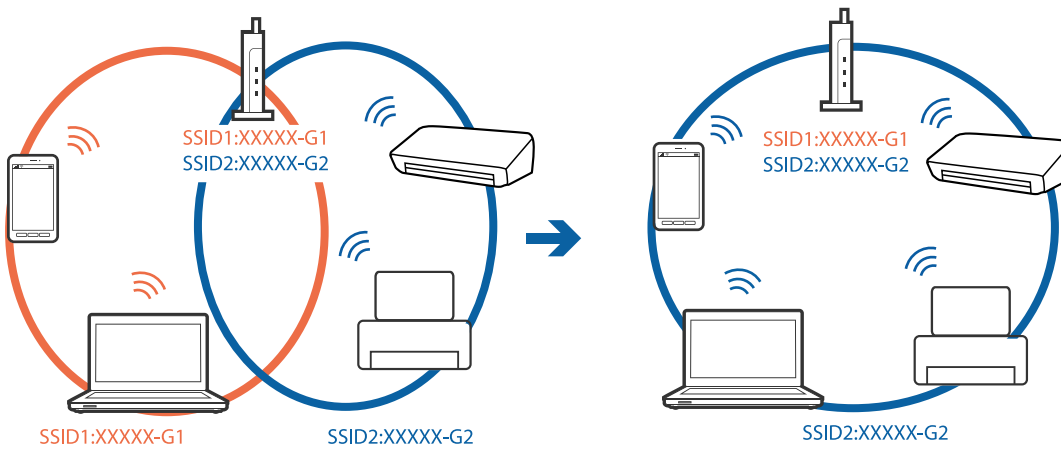

- ❑ An access point that is compliant with both IEEE802.11a and IEEE802.11g has SSIDs of 2.4 GHz and 5 GHz. If you connect the computer or smart device to a 5 GHz SSID, you cannot connect to the printer because the printer only supports communication over 2.4 GHz. Connect the computer or smart device to the same SSID as the printer.

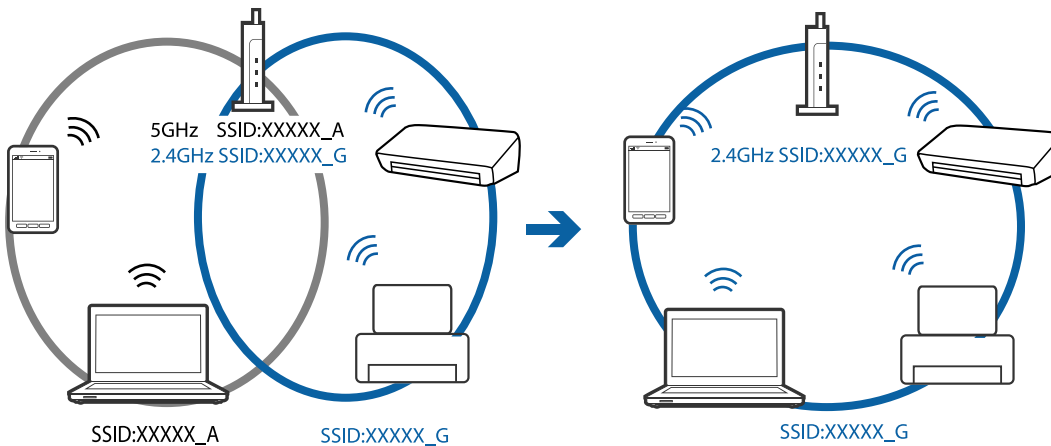

- ❑ Most access points have a privacy separator feature that blocks communication between connected devices. If you cannot communicate between the printer and the computer or smart device even if they are connected to the same network, disable the privacy separator on the access point. See the manual provided with the access point for details.

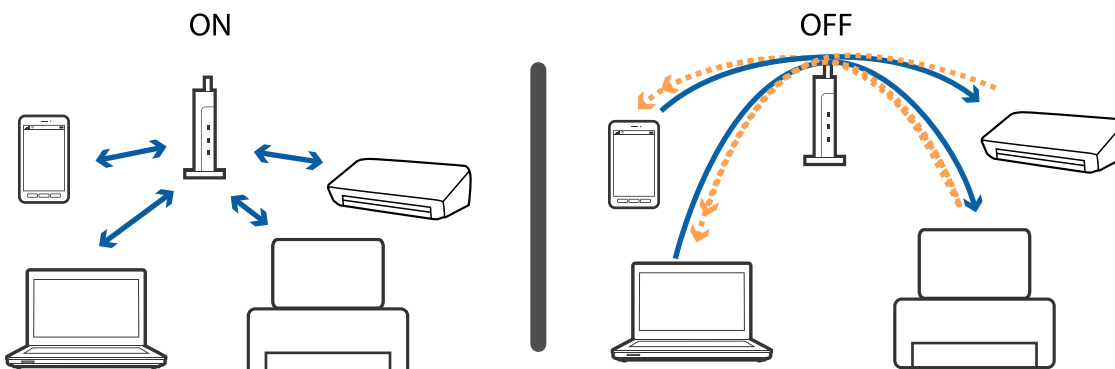

Solving Problems

Related Information

- ➔ [“Checking the SSID Connected to the Printer” on page 140](#)
- ➔ [“Checking the SSID for the Computer” on page 140](#)

Checking the SSID Connected to the Printer

You can check the SSID by printing a network connection report, network status sheet, or on Web Config.

Related Information

- ➔ [“Printing a Network Connection Report” on page 27](#)
- ➔ [“Printing a Network Status Sheet” on page 34](#)
- ➔ [“Running Web Config on a Web Browser” on page 118](#)

Checking the SSID for the Computer

Windows

Click  in the task tray on the desktop. Check the name of the connected SSID from the list displayed.

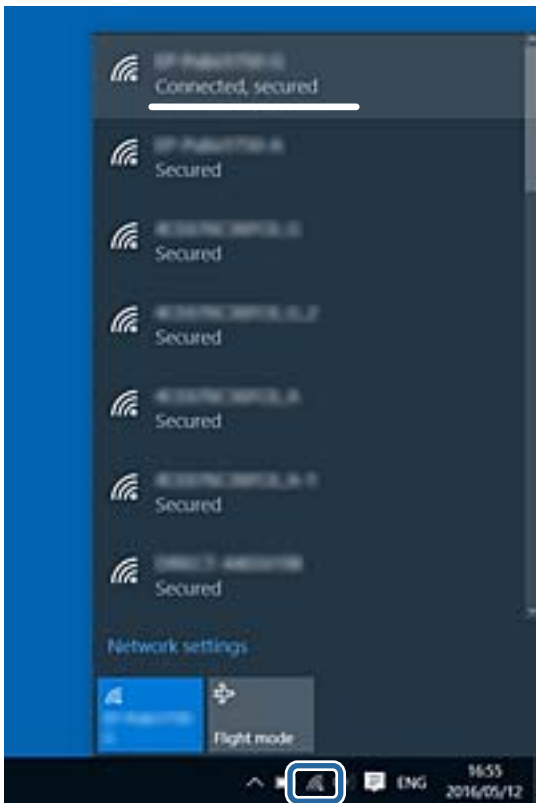

Mac OS

Click the Wi-Fi icon at the top of the computer screen. A list of SSIDs is displayed and the connected SSID is indicated with a check mark.



Cannot Print from an iPhone or iPad

- Connect the iPhone or iPad to the same network (SSID) as the printer.
- Enable **Paper Setup Auto Display** in the following menus.
Settings > Printer Setup > Paper Source Settings > Paper Setup Auto Display
- Enable the AirPrint setting on Web Config.

Related Information

- ➔ [“Connecting to a Smart Device” on page 23](#)
- ➔ [“Application for Configuring Printer Operations \(Web Config\)” on page 118](#)

Printout Problems

Printout is Scuffed or Color is Missing

- If you have not used the printer for a long time, the print head nozzles may be clogged and ink drops may not be discharged. Perform a nozzle check, and then clean the print head if any of the print head nozzles are clogged.
- If you printed when the ink levels were too low to be seen in the ink tank windows, refill the ink tanks to the upper lines and then use the **Power Cleaning** utility to replace the ink inside the ink tubes. After you use the utility, perform a nozzle check to see if print quality has improved.

Related Information

- ➔ [“Checking and Cleaning the Print Head” on page 107](#)
- ➔ [“Refilling the Ink Tanks” on page 102](#)

Solving Problems

➔ [“Running Power Cleaning” on page 108](#)

Banding or Unexpected Colors Appear

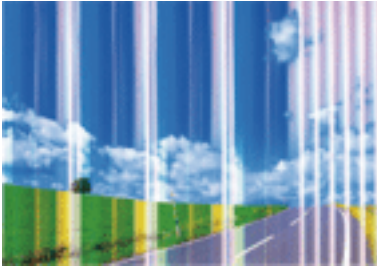

The print head nozzles may be clogged. Perform a nozzle check to check if the print head nozzles are clogged. Clean the print head if any of the print head nozzles are clogged.

Related Information

➔ [“Checking and Cleaning the Print Head” on page 107](#)

Colored Banding Appears at Intervals of Approximately 2.5 cm



- Select the appropriate paper type setting for the type of paper loaded in the printer.
- Align the print head using the **Horizontal Alignment** feature.
- When printing on plain paper, print using a higher quality setting.

Related Information

➔ [“List of Paper Type” on page 42](#)

➔ [“Aligning the Print Head” on page 110](#)

Blurry Prints, Vertical Banding, or Misalignment



enthalten alle
Aufdruck. W
5008 "Regel

Align the print head using the **Vertical Alignment** feature.

Related Information

➔ [“Aligning the Print Head” on page 110](#)

Print Quality Does Not Improve Even After Aligning the Print Head

During bidirectional (or high speed) printing, the print head prints while moving in both directions, and vertical lines may be misaligned. If print quality does not improve, disable the bidirectional (or high speed) setting. Disabling this setting may slow down printing speed.

Control panel

Disable **Bidirectional** in **Settings > Printer Setup**.

Windows

Clear **High Speed** on the printer driver's **More Options** tab.

Mac OS

Select **System Preferences** from the  menu > **Printers & Scanners** (or **Print & Scan, Print & Fax**), and then select the printer. Click **Options & Supplies > Options** (or **Driver**). Select **Off** as the **High Speed Printing** setting.

Print Quality is Poor

Check the following if the print quality is poor due to blurry prints, banding, missing colors, faded colors, and misalignment in the prints.

Checking the printer

- Make sure the initial ink charging is complete.
- Refill the ink tank if the ink level is below the lower line.
- Perform a nozzle check, and then clean the print head if any of the print head nozzles are clogged.
- Align the print head.

Checking the paper

- Use paper supported by this printer.
- Do not print on paper that is damp, damaged, or too old.

Solving Problems

- If the paper is curled or the envelope is puffed up, flatten it.
- Do not stack the paper immediately after printing.
- Dry the printouts completely before filing or displaying them. When drying the printouts, avoid direct sun light, do not use a dryer, and do not touch the printed side of paper.
- When printing images or photos, Epson recommends using genuine Epson paper rather than plain paper. Print on the printable side of the genuine Epson paper.

Checking the print settings

- Select the appropriate paper type setting for the type of paper loaded in the printer.
- Print using a higher quality setting.

Checking the ink bottle

- Use ink bottles with the correct part code for this printer.
- Epson recommends using the ink bottle before the date printed on the package.
- Try to use genuine Epson ink bottles. This product is designed to adjust colors based on the use of genuine Epson ink bottles. The use of non-genuine ink bottles may cause print quality to decline.

Related Information

- ➔ [“Checking and Cleaning the Print Head” on page 107](#)
- ➔ [“Aligning the Print Head” on page 110](#)
- ➔ [“Available Paper and Capacities” on page 37](#)
- ➔ [“List of Paper Type” on page 42](#)
- ➔ [“Paper Handling Precautions” on page 38](#)

Paper Is Smearred or Scuffed

- When horizontal banding appears or the top or bottom of the paper is smearred, load paper in the correct direction and slide the edge guides to the edges of the paper.

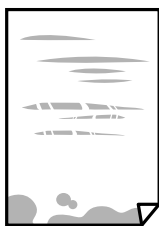

- When vertical banding appears or the paper is smearred, clean the paper path.



Solving Problems

- ❑ When the problem cannot be cleared after cleaning the paper path, the part inside the printer that is shown in the illustration is smeared. Turn off the printer, and then wipe off the ink using a cotton swab.

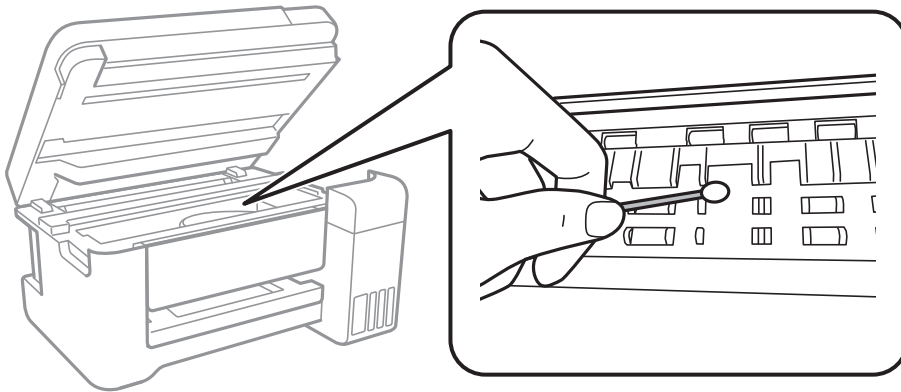

Do not touch the white flat cable, translucent film, and ink tubes inside the printer. Doing so may cause a malfunction.

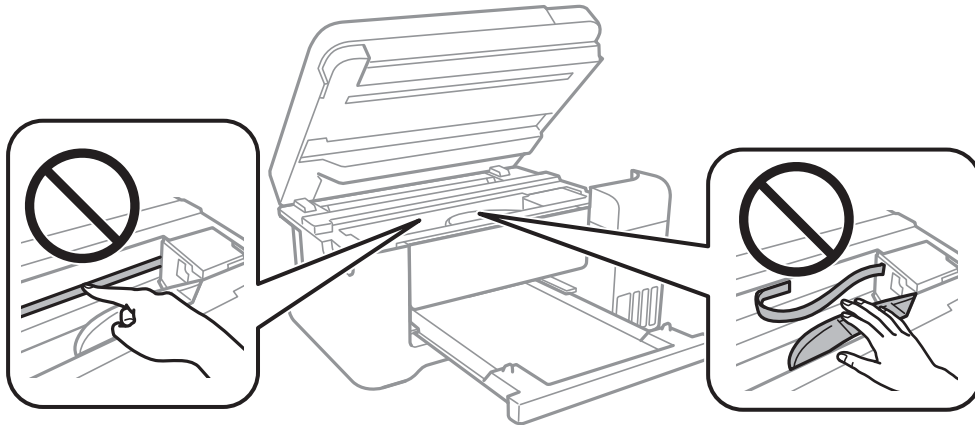

- ❑ Place the paper on a flat surface to check if it is curled. If it is, flatten it.
- ❑ When performing manual 2-sided printing, make sure that the ink is completely dry before reloading the paper.

Related Information

- ➔ [“Loading Paper in the Rear Paper Feed” on page 39](#)
- ➔ [“Cleaning the Paper Path for Ink Smears” on page 111](#)

Paper is Smeared During Automatic 2-Sided Printing

When using the automatic 2-sided printing feature and printing high density data such as images and graphs, set the print density to lower and the drying time to longer.

Related Information

- ➔ [“Menu Options for Printer Setup” on page 47](#)

Printed Photos are Sticky

You may be printing on the wrong side of the photo paper. Make sure you are printing on the printable side.

When printing on the wrong side of the photo paper, you need to clean the paper path.

Related Information

➔ [“Cleaning the Paper Path for Ink Smears” on page 111](#)

Images or Photos are Printed in Unexpected Colors

When printing from the control panel or from the Windows printer driver, the Epson auto photo adjustment setting is applied by default depending on the paper type. Try change the setting.

Control panel

Change the **Fix Photo** setting from **Auto** to any other option. If changing the setting does not work, select **Enhance Off** as the **Fix Photo** setting.

Windows printer driver

On the **More Options** tab, select **Custom** in **Color Correction**, and then click **Advanced**. Change the **Scene Correction** setting from **Auto Correct** to any other option. If changing the setting does not work, use any color correction method other than **PhotoEnhance** in **Color Management**.

Related Information

➔ [“Menu Options for Print Photos” on page 81](#)

➔ [“Adjusting the Print Color” on page 68](#)

Cannot Print Without Margins

Make borderless setting in the print settings. If you select a paper type that does not support borderless printing, you cannot select **Borderless**. Select a paper type that supports borderless printing.

Related Information

➔ [“Menu Options for Copying” on page 87](#)

➔ [“Printing Basics” on page 54](#)

➔ [“Printing Basics” on page 72](#)

Edges of the Image are Cropped During Borderless Printing

During borderless printing, the image is slightly enlarged and the protruding area is cropped. Select a smaller enlargement setting.

Control panel

Change the **Expansion** setting.

Windows

Click **Settings** next to the **Borderless** checkbox on the printer driver's **Main** tab, and then change the settings.

Solving Problems

Mac OS

Change the **Expansion** setting from the print dialog's **Print Settings** menu.

Related Information

➔ [“Menu Options for Copying” on page 87](#)

The Position, Size, or Margins of the Printout Are Incorrect

- Load paper in the correct direction, and slide the edge guides against the edges of the paper.
- When placing the originals on the scanner glass, align the corner of the original with the corner indicated by a symbol on the frame of the scanner glass. If the edges of the copy are cropped off, move the original slightly away from the corner.
- When placing the originals on the scanner glass, clean the scanner glass and the document cover. If there is dust or stains on the glass, the copy area may extend to include the dust or stains, resulting in the wrong copying position or small images.
- Select the appropriate **Original Size** in the copy settings.
- Select the appropriate paper size setting.
- Adjust the margin setting in the application so that it falls within the printable area.

Related Information

- ➔ [“Loading Paper in the Rear Paper Feed” on page 39](#)
- ➔ [“Placing Originals on the Scanner Glass” on page 43](#)
- ➔ [“Cleaning the Scanner Glass” on page 112](#)
- ➔ [“Printable Area” on page 156](#)

Printed Characters Are Incorrect or Garbled

- Connect the USB cable securely to the printer and the computer.
- Cancel any paused print jobs.
- Do not put the computer manually into the **Hibernate** mode or the **Sleep** mode while printing. Pages of garbled text may be printed next time you start the computer.
- If you use the printer driver you had previously used, printed characters may be garbled. Make sure that the printer driver you are using is for this printer. Check the printer name on the top of the printer driver window.

The Printed Image Is Inverted

Clear any mirror image settings in the printer driver or the application.

Windows

Clear **Mirror Image** on the printer driver's **More Options** tab.

Mac OS

Clear **Mirror Image** from the print dialog's **Print Settings** menu.

Mosaic-Like Patterns in the Prints

When printing images or photos, print using high-resolution data. Images on websites are often low resolution although they look good enough on the display, and so print quality may decline.

Uneven Colors, Smears, Dots, or Straight Lines Appear in the Copied Image

- Clean the paper path.
- Clean the scanner glass.
- Do not press too hard on the original or the document cover when you are placing the originals on the scanner glass.
- When the paper is smeared, lower the copy density setting.

Related Information

- ➔ [“Cleaning the Paper Path for Ink Smears” on page 111](#)
- ➔ [“Cleaning the Scanner Glass” on page 112](#)
- ➔ [“Menu Options for Copying” on page 87](#)

Moiré (Cross-Hatch) Patterns Appear in the Copied Image

Change the reduce and enlarge setting or place the original at a slightly different angle.

Related Information

- ➔ [“Menu Options for Copying” on page 87](#)

An Image of the Reverse Side of the Original Appears in the Copied Image

- For a thin original, place the original on the scanner glass and then place a piece of black paper over it.
- Lower the copy density setting on the control panel.

Related Information

- ➔ [“Menu Options for Copying” on page 87](#)

The Printout Problem Could Not be Cleared



If you have tried all of the solutions and have not solved the problem, try uninstalling and then reinstalling the printer driver.

Related Information

- ➔ [“Uninstalling Applications” on page 124](#)
- ➔ [“Installing the Latest Applications” on page 123](#)

Other Printing Problems

Printing Is Too Slow

- Close any unnecessary applications.
- Lower the quality setting. High quality printing slows down the printing speed.
- Enable the bidirectional (or high speed) setting. When this setting is enabled, the print head prints while moving in both directions, and the printing speed increases.
 - Control Panel
From the home screen, select **Settings > Printer Setup > Bidirectional**, and then enable it.
 - Windows
Select **High Speed** on the printer driver's **More Options** tab.
 - Mac OS
Select **System Preferences** from the  menu > **Printers & Scanners** (or **Print & Scan, Print & Fax**), and then select the printer. Click **Options & Supplies > Options** (or **Driver**). Select **On** as the **High Speed Printing** setting.
- Disable quiet mode. This feature slows down the printing speed.
 - Control Panel
Select  on the home screen, and then disable **Quiet Mode**.
 - Windows
Select **Off** as the **Quiet Mode** setting on the printer driver's **Main** tab.
 - Mac OS
Select **System Preferences** from the  menu > **Printers & Scanners** (or **Print & Scan, Print & Fax**), and then select the printer. Click **Options & Supplies > Options** (or **Driver**). Select **Off** as the **Quiet Mode** setting.

Printing Slows Down Dramatically During Continuous Printing

Printing slows down to prevent the printer mechanism from overheating and being damaged. However, you can continue printing. To return to normal printing speed, leave the printer idle for at least 30 minutes. Printing speed does not return to normal if the power is off.

Cannot Cancel Printing from a Computer Running Mac OS X v10.6.8

If you want to stop printing from your computer, make the following settings.

Solving Problems

Run Web Config, and then select **Port9100** as the **Top Priority Protocol** setting in **AirPrint Setup**. Select **System Preferences** from the  menu > **Printers & Scanners** (or **Print & Scan**, **Print & Fax**), remove the printer, and then add the printer again.

Cannot Start Scanning

- Connect the USB cable securely to the printer and the computer. If you are using a USB hub, try to connect the printer directly to the computer.
- If you scan at a high resolution over a network, a communication error may occur. Lower the resolution.
- Make sure that the correct printer (scanner) is selected on Epson Scan 2.

Check whether or not the printer is recognized when using Windows

In Windows, make sure the printer (scanner) is displayed in **Scanner and Camera**. The printer (scanner) should be displayed as "EPSON XXXXX (printer name)". If the printer (scanner) is not displayed, uninstall and then re-install Epson Scan 2. See the following to access **Scanner and Camera**.

Windows 10

Right-click the start button or press and hold it, select **Control Panel**, enter "Scanner and Camera" in the search charm, click **View scanners and cameras**, and then check if the printer is displayed.

Windows 8.1/Windows 8/Windows Server 2012 R2/Windows Server 2012

Select **Desktop > Settings > Control Panel**, enter "Scanner and Camera" in the search charm, click **Show Scanner and Camera**, and then check if the printer is displayed.

Windows 7/Windows Server 2008 R2

Click the start button and select **Control Panel**, enter "Scanner and Camera" in the search charm, click **View scanners and cameras**, and then check if the printer is displayed.

Windows Vista/Windows Server 2008

Click the start button, select **Control Panel > Hardware and Sound > Scanners and Cameras**, and then check if the printer is displayed.

Windows XP/Windows Server 2003 R2/Windows Server 2003

Click the start button, select **Control Panel > Printers and Other Hardware > Scanner and Cameras**, and then check if the printer is displayed.

Related Information

- ➔ ["Uninstalling Applications" on page 124](#)
- ➔ ["Installing the Latest Applications" on page 123](#)

Scanned Image Problems

Uneven Colors, Dirt, Spots, and so on Appear when Scanning from the Scanner Glass

- Clean the scanner glass.

Solving Problems

- ❑ Remove any trash or dirt that adheres to the original.
- ❑ Do not press with too much force on the original or the document cover. If you press with too much force, blurring, smudges, and spots may occur.

Related Information

- ➔ [“Cleaning the Scanner Glass” on page 112](#)

The Image Quality Is Rough

- ❑ In Epson Scan 2, adjust the image using items on the **Advanced Settings** tab, and then scan.
- ❑ If the resolution is low, try increasing the resolution and then scanning.

Related Information

- ➔ [“Scanning Using Epson Scan 2” on page 95](#)

Offset Appears in the Background of Images

Images on the back of the original may appear in the scanned image.

- ❑ In Epson Scan 2, select the **Advanced Settings** tab, and then adjust the **Brightness**.
This feature may not be available depending on the settings on the **Main Settings** tab > **Image Type** or other settings on the **Advanced Settings** tab.
- ❑ In Epson Scan 2, select the **Advanced Settings** tab, and then **Image Option** > **Text Enhancement**.
- ❑ When scanning from the scanner glass, place black paper or a desk pad over the original.

Related Information

- ➔ [“Scanning Using Epson Scan 2” on page 95](#)
- ➔ [“Placing Originals” on page 43](#)

Text is Blurred

- ❑ In Epson Scan 2, select the **Advanced Settings** tab, and then **Image Option** > **Text Enhancement**.
- ❑ In Epson Scan 2, when **Image Type** on the **Main Settings** tab is set to **Black & White**, adjust the **Threshold** on the **Advanced Settings** tab. When you increase the **Threshold**, black becomes stronger.
- ❑ If the resolution is low, try increasing the resolution and then scanning.

Related Information

- ➔ [“Scanning Using Epson Scan 2” on page 95](#)

Moiré Patterns (Web-Like Shadows) Appear

If the original is a printed document, moiré patterns (web-like shadows) may appear in the scanned image.

Solving Problems

- ❑ On the **Advanced Settings** tab in Epson Scan 2, set **Descreening**.



- ❑ Change the resolution, and then scan again.

Related Information

- ➔ [“Scanning Using Epson Scan 2” on page 95](#)

Cannot Scan the Correct Area on the Scanner Glass

- ❑ Make sure the original is placed correctly against the alignment marks.
- ❑ If the edge of the scanned image is missing, move the original slightly away from the edge of the scanner glass.
- ❑ When scanning from the control panel and selecting the auto scan area cropping function, remove any trash or dirt from the scanner glass and document cover. If there is any trash or dirt around the original, the scanning range expands to include it.

Related Information

- ➔ [“Placing Originals” on page 43](#)
- ➔ [“Cleaning the Scanner Glass” on page 112](#)

Text is Not Recognized Correctly when Saving as a Searchable PDF

- ❑ On the **Image Format Options** window in Epson Scan 2, check that **Text Language** is set correctly on the **Text** tab.
- ❑ Check that the original is placed straight.
- ❑ Use an original with clear text. Text recognition may decline for the following types of originals.
 - ❑ Originals that have been copied a number of times
 - ❑ Originals received by fax (at low resolutions)
 - ❑ Originals on which the letter spacing or line spacing is too small
 - ❑ Originals with ruled lines or underlining over the text
 - ❑ Originals with hand-written text
 - ❑ Originals with creases or wrinkles
- ❑ In Epson Scan 2, when **Image Type** on the **Main Settings** tab is set to **Black & White**, adjust the **Threshold** on the **Advanced Settings** tab. When you increase the **Threshold**, the black color area becomes larger.
- ❑ In Epson Scan 2, select the **Advanced Settings** tab, and then **Image Option > Text Enhancement**.

Related Information

➔ [“Scanning Using Epson Scan 2” on page 95](#)

Cannot Solve Problems in the Scanned Image

If you have tried all of the solutions and have not solved the problem, initialize the Epson Scan 2 settings using Epson Scan 2 Utility.

Note:

Epson Scan 2 Utility is an application that comes with Epson Scan 2.

1. Start Epson Scan 2 Utility.
 - Windows 10/Windows Server 2016
Click the start button, and then select **EPSON > Epson Scan 2 Utility**.
 - Windows 8.1/Windows 8/Windows Server 2012 R2/Windows Server 2012
Enter the application name in the search charm, and then select the displayed icon.
 - Windows 7/Windows Vista/Windows XP/Windows Server 2008 R2/Windows Server 2008/Windows Server 2003 R2/Windows Server 2003
Click the start button, and then select **All Programs or Programs > EPSON > Epson Scan 2 > Epson Scan 2 Utility**.
 - Mac OS
Select **Go > Applications > Epson Software > Epson Scan 2 Utility**.
2. Select the **Other** tab.
3. Click **Reset**.

Note:

If initialization does not solve the problem, uninstall and re-install Epson Scan 2.

Related Information

- ➔ [“Uninstalling Applications” on page 124](#)
➔ [“Installing the Latest Applications” on page 123](#)

Other Scanning Problems

Scanning Speed Is Slow

- Lower the resolution, and then scan again. When the resolution is high, scanning may take some time.
- The scanning speed may be reduced depending on the image adjustment features in Epson Scan 2.
- On the **Configuration** screen which is displayed by clicking the  button in Epson Scan 2, if you set **Quiet Mode** on the **Scan** tab, the scanning speed may be reduced.

Related Information

➔ [“Scanning Using Epson Scan 2” on page 95](#)

Scanning Stops when Scanning to PDF/Multi-TIFF

- When scanning using Epson Scan 2, you can continuously scan up to 999 pages in PDF format and up to 200 pages in Multi-TIFF format.
- When scanning large volumes, we recommend scanning in grayscale.
- Increase the free space on the computer's hard disk. Scanning may stop if there is not enough free space.
- Try scanning at a lower resolution. Scanning stops if the total data size reaches the limit.

Related Information

➔ [“Scanning Using Epson Scan 2” on page 95](#)

Other Problems

Slight Electric Shock when Touching the Printer

If many peripherals are connected to the computer, you may feel a slight electric shock when touching the printer. Install a ground wire to the computer that is connected to the printer.

Operation Sounds Are Loud

If operations sounds are too loud, enable **Quiet Mode**. Enabling this feature may reduce printing speed.

- Control panel

Select  on the home screen, and then enable **Quiet Mode**.

- Windows printer driver

Enable **Quiet Mode** on the **Main** tab.

- Mac OS printer driver

Select **System Preferences** from the  menu > **Printers & Scanners** (or **Print & Scan, Print & Fax**), and then select the printer. Click **Options & Supplies** > **Options** (or **Driver**). Select **On** as the **Quiet Mode** setting.

- Epson Scan 2

Click the  button to open the **Configuration** window. Next, set the **Quiet Mode** on the **Scan** tab.

Cannot Save Data to a Memory Device

- Check that the memory device is not write protected.
- Check that the memory device has enough available memory. If the available memory is low, data cannot be saved.

Solving Problems

Related Information

➔ [“External Storage Device Specifications” on page 159](#)

Application Is Blocked by a Firewall (for Windows Only)

Add the application to the Windows Firewall allowed program in security settings on the **Control Panel**.

"?" Is Displayed on the Photo Selection Screen

"?" is displayed on the LCD screen when the image file is not supported by the product.

A Message Prompting You to Reset the Ink Levels is Displayed

Refill all or the specified ink tanks, select the color that you refilled on the LCD screen, and then reset the ink levels.

Depending on the usage conditions, the message may be displayed when there is still ink in the tank.

Related Information

➔ [“Refilling the Ink Tanks” on page 102](#)

Ink Spilled

- If ink adheres to the area around the tank, wipe it off using a napless, clean cloth or cotton swab.
- If ink spills on the desk or floor, wipe it off immediately. When ink is dried, it will be difficult to remove the smear. To prevent the smear from spreading, blot the ink with a dry cloth, and then wipe it with a moist cloth.
- If ink gets on your hands, wash them with water and soap.

Appendix

Technical Specifications

Printer Specifications

Print Head Nozzle Placement		Black ink nozzles: 180 Color ink nozzles: 59 for each color
Weight of Paper*	Plain Paper	64 to 90 g/m ² (17 to 24lb)
	Envelopes	Envelope #10, DL, C6: 75 to 90 g/m ² (20 to 24 lb)

* Even when the paper thickness is within this range, the paper may not feed in the printer or the print quality may decline depending on the paper properties or quality.

Printable Area

Printable Area for Single Sheets

Print quality may decline in the shaded areas due to the printer's mechanism.

Printing with borders

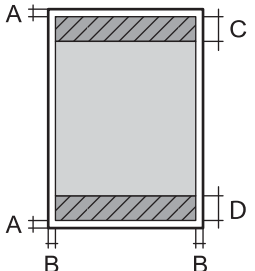
	A	3.0 mm (0.12 in.)
	B	3.0 mm (0.12 in.)
	C	41.0 mm (1.61 in.)
	D	37.0 mm (1.46 in.)

Borderless printing

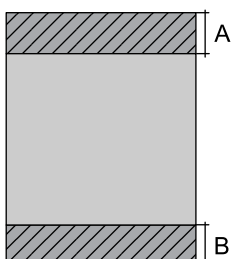
	A	44.0 mm (1.73 in.)
	B	40.0 mm (1.57 in.)

Appendix

Printable Area for Envelopes

Print quality may decline in the shaded areas due to the printer's mechanism.

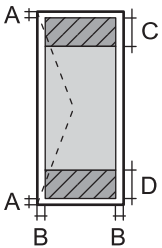
	A	3.0 mm (0.12 in.)
	B	5.0 mm (0.20 in.)
	C	18.0 mm (0.70 in.)
	D	41.0 mm (1.61 in.)

Scanner Specifications

Scanner Type	Flatbed
Photoelectric Device	CIS
Effective Pixels	10200×14040 pixels (1200 dpi)
Maximum Document Size	216×297 mm (8.5×11.7 in.) A4, Letter
Scanning Resolution	1200 dpi (main scan) 2400 dpi (sub scan)
Output Resolution	50 to 9600 dpi in 1 dpi increments
Color Depth	<p>Color</p> <ul style="list-style-type: none"> <input type="checkbox"/> 48 bits per pixel internal (16 bits per pixel per color internal) <input type="checkbox"/> 24 bits per pixel external (8 bits per pixel per color external) <p>Grayscale</p> <ul style="list-style-type: none"> <input type="checkbox"/> 16 bits per pixel internal <input type="checkbox"/> 8 bits per pixel external <p>Black and white</p> <ul style="list-style-type: none"> <input type="checkbox"/> 16 bits per pixel internal <input type="checkbox"/> 1 bits per pixel external
Light Source	LED

Interface Specifications

For Computer	Hi-Speed USB
--------------	--------------

Appendix

Network Function List

Network Functions and IPv4/IPv6

Functions			Supported	Remarks
Network Printing	EpsonNet Print (Windows)	IPv4	✓	-
	Standard TCP/IP (Windows)	IPv4, IPv6	✓	-
	WSD Printing (Windows)	IPv4, IPv6	✓	Windows Vista or later
	Bonjour Printing (Mac OS)	IPv4, IPv6	✓	-
	IPP Printing (Windows, Mac OS)	IPv4, IPv6	✓	-
	UPnP Printing	IPv4	-	Information appliance
	PictBridge Printing (Wi-Fi)	IPv4	-	Digital camera
	Epson Connect (Email Print)	IPv4	✓	-
	AirPrint (iOS, Mac OS)	IPv4, IPv6	✓	iOS 5 or later, Mac OS X v10.7 or later
	Google Cloud Print	IPv4, IPv6	✓	-
Network Scanning	Epson Scan 2	IPv4, IPv6	✓	-
	Event Manager	IPv4	✓	-
	Epson Connect (Scan to Cloud)	IPv4	-	-
	AirPrint (Scan)	IPv4, IPv6	✓	OS X Mavericks or later
	ADF (2-sided scanning)		-	-
Fax	Send a fax	IPv4	-	-
	Receive a fax	IPv4	-	-
	AirPrint (Faxout)	IPv4, IPv6	-	-

Wi-Fi Specifications

Standards	IEEE802.11b/g/n ^{*1*2}
Frequency Range	2.4 GHz
Maximum Radio-Frequency Power Transmitted	19.8 dBm (EIRP)
Coordination Modes	Infrastructure, Wi-Fi Direct (Simple AP) ^{*3}

Appendix

Wireless Securities	WEP (64/128bit),WPA2-PSK (AES)* ⁴
---------------------	--

*1 Complies with either IEEE 802.11b/g/n or IEEE 802.11b/g depending on location of purchase.

*2 IEEE802.11n is only available for the HT20.

*3 Not supported for IEEE 802.11b.

*4 Complies with WPA2 standards with support for WPA/WPA2 Personal.

Security Protocol

SSL/TLS	HTTPS Server/Client, IPPS
---------	---------------------------

Supported Third Party Services

AirPrint	Print	iOS 5 or later/Mac OS X v10.7.x or later
	Scan	OS X Mavericks or later
Google Cloud Print		

External Storage Device Specifications

Supported Memory Card Specifications

Compatible Memory Cards	Maximum Capacities
miniSD*	2 GB
miniSDHC*	32 GB
microSD*	2 GB
microSDHC*	32 GB
microSDXC*	64 GB
SD	2 GB
SDHC	32 GB
SDXC	64 GB

* Attach an adapter to fit the memory card slot. Otherwise, the card may get stuck.

Appendix

Supported Data Specifications

File Format	JPEGs (*.JPG) with the Exif Version 2.31 standard taken by digital cameras DCF* ¹ version 1.0 or 2.0* ² compliant
Image Size	Horizontal: 80 to 10200 pixels Vertical: 80 to 10200 pixels
File Size	Less than 2 GB
Maximum Number of Files	2000

*1 Design rule for Camera File system.

*2 Photo data stored in the built-in memory of a digital camera is not supported.

Note:

"?" is displayed on the LCD screen when the printer cannot recognize the image file. In this situation, if you select a multiple image layout, blank sections will be printed.

Dimensions

Dimensions	<p>Storage</p> <ul style="list-style-type: none"> <input type="checkbox"/> Width: 375 mm (14.8 in.) <input type="checkbox"/> Depth: 347 mm (13.7 in.) <input type="checkbox"/> Height: 187 mm (7.4 in.) <p>Printing</p> <ul style="list-style-type: none"> <input type="checkbox"/> Width: 375 mm (14.8 in.) <input type="checkbox"/> Depth: 567 mm (22.3 in.) <input type="checkbox"/> Height: 259 mm (10.2 in.)
Weight*	Approx. 5.5 kg (12.1 lb)

* Without the ink and the power cord.

Electrical Specifications

Model	100 to 240 V Model	220 to 240 V Model
Rated Frequency Range	50 to 60 Hz	50 to 60 Hz
Rated Current	0.4 to 0.2 A	0.2 A
Power Consumption (with USB Connection)	<p>Standalone copying: Approx. 12.0 W (ISO/IEC24712)</p> <p>Ready mode: Approx. 4.3 W</p> <p>Sleep mode: Approx. 0.7 W</p> <p>Power off: Approx. 0.2 W</p>	<p>Standalone copying: Approx. 12.0 W (ISO/IEC24712)</p> <p>Ready mode: Approx. 4.3 W</p> <p>Sleep mode: Approx. 0.7 W</p> <p>Power off: Approx. 0.3 W</p>

Appendix

Note:

- Check the label on the printer for its voltage.
- For European users, see the following Website for details on power consumption.
<http://www.epson.eu/energy-consumption>

Environmental Specifications

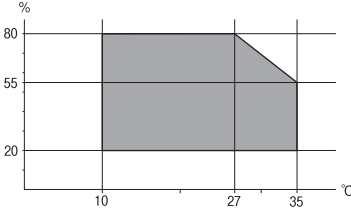
Operation	<p>Use the printer within the range shown in the following graph.</p>  <p>Temperature: 10 to 35°C (50 to 95°F) Humidity: 20 to 80% RH (without condensation)</p>
Storage	<p>Temperature: -20 to 40°C (-4 to 104°F)* Humidity: 5 to 85% RH (without condensation)</p>

* You can store for one month at 40°C (104°F).

Environmental Specifications for Ink Bottles

Storage Temperature	-20 to 40 °C (-4 to 104 °F)*
Freezing Temperature	<p>-15 °C (5 °F) Ink thaws and is usable after approximately 2 hours at 25 °C (77 °F).</p>

* You can store for one month at 40 °C (104 °F).

System Requirements

- Windows 10 (32-bit, 64-bit)/Windows 8.1 (32-bit, 64-bit)/Windows 8 (32-bit, 64-bit)/Windows 7 (32-bit, 64-bit)/Windows Vista (32-bit, 64-bit)/Windows XP SP3 or later (32-bit)/Windows XP Professional x64 Edition/Windows Server 2016/Windows Server 2012 R2/Windows Server 2012/Windows Server 2008 R2/Windows Server 2008/Windows Server 2003 R2/Windows Server 2003 SP2 or later
- macOS Sierra/OS X El Capitan/OS X Yosemite/OS X Mavericks/OS X Mountain Lion/Mac OS X v10.7.x/Mac OS X v10.6.8

Note:

- Mac OS may not support some applications and features.
- The UNIX File System (UFS) for Mac OS is not supported.

Regulatory Information

Standards and Approvals

Standards and Approvals for U.S. Model

Safety	UL60950-1 CAN/CSA-C22.2 No.60950-1
EMC	FCC Part 15 Subpart B Class B CAN/CSA-CEI/IEC CISPR 22 Class B

This equipment contains the following wireless module.

Manufacturer: Askey Computer Corporation

Type: WLU6320-D69 (RoHS)

This product conforms to Part 15 of the FCC Rules and RSS-210 of the IC Rules. Epson cannot accept responsibility for any failure to satisfy the protection requirements resulting from a non-recommended modification of the product. Operation is subject to the following two conditions: (1) this device may not cause harmful interference, and (2) this device must accept any interference received, including interference that may cause undesired operation of the device.

To prevent radio interference to the licensed service, this device is intended to be operated indoors and away from windows to provide maximum shielding. Equipment (or its transmit antenna) that is installed outdoors is subject to licensing.

This equipment complies with FCC/IC radiation exposure limits set forth for an uncontrolled environment and meets the FCC radio frequency (RF) Exposure Guidelines in Supplement C to OET65 and RSS-102 of the IC radio frequency (RF) Exposure rules. This equipment should be installed and operated so that the radiator is kept at least 7.9 inches (20 cm) or more away from a person's body (excluding extremities: hands, wrists, feet and ankles).

Standards and Approvals for European Model

For European users

Hereby, Seiko Epson Corporation declares that the following radio equipment model is in compliance with Directive 2014/53/EU. The full text of the EU declaration of conformity is available at the following website.

<http://www.epson.eu/conformity>

C634A

For use only in Ireland, UK, Austria, Germany, Liechtenstein, Switzerland, France, Belgium, Luxemburg, Netherlands, Italy, Portugal, Spain, Denmark, Finland, Norway, Sweden, Iceland, Croatia, Cyprus, Greece, Slovenia, Malta, Bulgaria, Czech, Estonia, Hungary, Latvia, Lithuania, Poland, Romania, and Slovakia.

Epson cannot accept responsibility for any failure to satisfy the protection requirements resulting from a non-recommended modification of the products.



Standards and Approvals for Australian Model

EMC	AS/NZS CISPR32 Class B
-----	------------------------

Epson hereby declares that the following equipment Models are in compliance with the essential requirements and other relevant provisions of AS/NZS4268:

C634A

Epson cannot accept responsibility for any failure to satisfy the protection requirements resulting from a non-recommended modification of the products.

ZICTA Type Approval for Users in Zambia

See the following website to check the information for ZICTA Type Approval.

<https://support.epson.net/zicta/>

Restrictions on Copying

Observe the following restrictions to ensure the responsible and legal use of the printer.

Copying of the following items is prohibited by law:

- Bank bills, coins, government-issued marketable securities, government bond securities, and municipal securities
- Unused postage stamps, pre-stamped postcards, and other official postal items bearing valid postage
- Government-issued revenue stamps, and securities issued according to legal procedure

Exercise caution when copying the following items:

- Private marketable securities (stock certificates, negotiable notes, checks, etc.), monthly passes, concession tickets, etc.
- Passports, driver's licenses, warrants of fitness, road passes, food stamps, tickets, etc.

Note:

Copying these items may also be prohibited by law.

Responsible use of copyrighted materials:

Printers can be misused by improperly copying copyrighted materials. Unless acting on the advice of a knowledgeable attorney, be responsible and respectful by obtaining the permission of the copyright holder before copying published material.

Transporting and Storing the Printer

When you need to store the printer or transport it when moving or for repairs, follow the steps below to pack the printer.



Caution:

Be careful not to trap your hand or fingers when opening or closing the scanner unit. Otherwise you may be injured.

Appendix

! **Important:**

- ❑ When storing or transporting the printer, place the printer in the plastic bag and fold it closed. Avoid tilting the printer, placing it vertically, or turning it upside down; otherwise ink may leak.

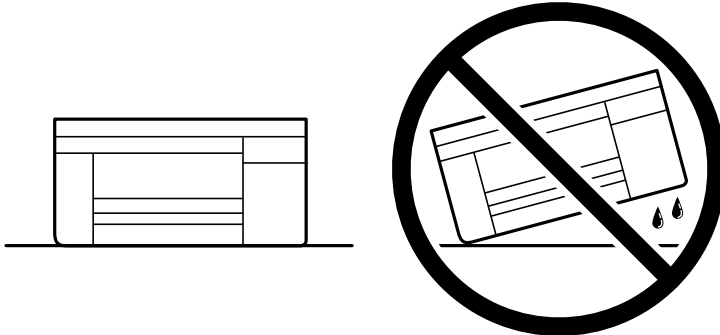

- ❑ When storing or transporting an ink bottle, do not tilt the bottle and do not subject it to impacts or temperature changes. Otherwise, ink may leak even if the cap on the ink bottle is tightened securely. Be sure to keep the ink bottle upright when tightening the cap, and take precautions to prevent ink from leaking when transporting the bottle, for example, putting the bottle in a bag.
- ❑ Do not put opened ink bottles in the box with printer.



1. Turn off the printer by pressing the  button.
2. Make sure the power light turns off, and then unplug the power cord.

! **Important:**

Unplug the power cord when the power light is off. Otherwise, the print head does not return to the home position causing the ink to dry, and printing may become impossible.

3. Disconnect all cables such as the power cord and USB cable.
4. Make sure there is no memory card inserted.
5. Remove all of the paper from the printer.
6. Make sure there are no originals on the printer.

Appendix

7. Open the scanner unit with the document cover closed. Secure the print head to the case with tape.

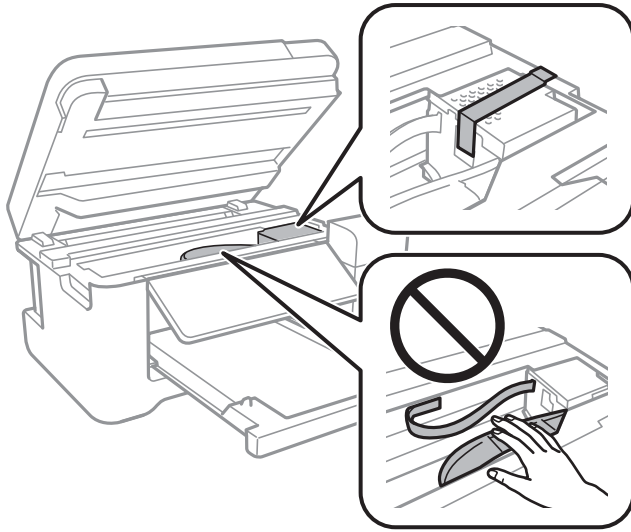

8. Make sure to install the cap onto the ink tank securely.

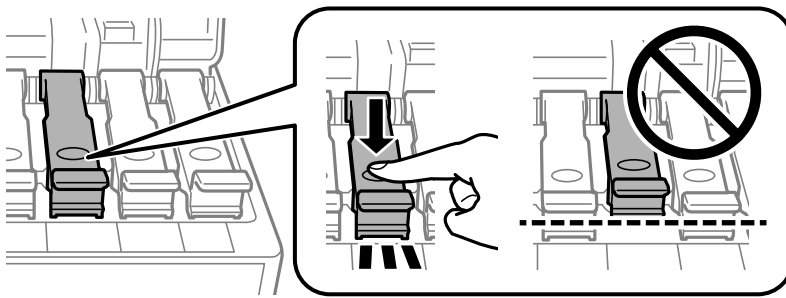

9. Close the Ink Tank Cover securely.

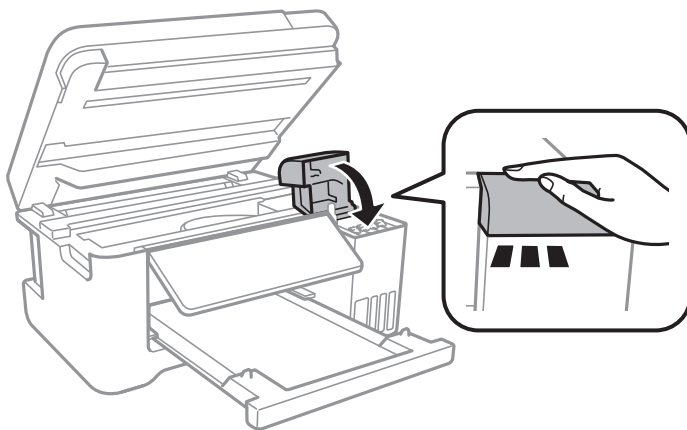

Appendix

10. Close the scanner unit.

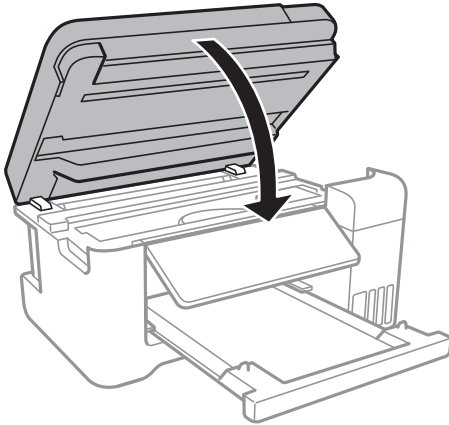

11. Prepare to pack the printer as shown below.

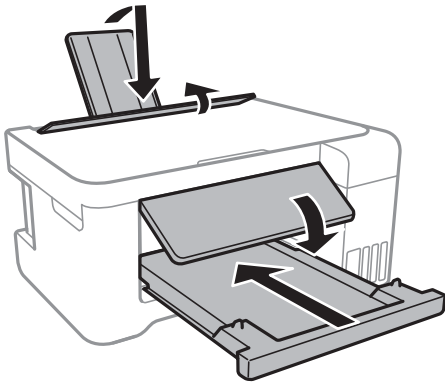

12. Place the printer in the plastic bag and fold it closed.
13. Pack the printer in its box using the protective materials.

! **Important:**

Make sure you keep the printer horizontal when transporting or storing the printer by packing it in its box; otherwise ink may leak.

When you use the printer again, make sure you remove the tape securing the print head. If print quality has declined the next time you print, clean and align the print head.

Related Information

- ➔ [“Part Names and Functions” on page 14](#)
- ➔ [“Checking and Cleaning the Print Head” on page 107](#)
- ➔ [“Aligning the Print Head” on page 110](#)

Copyright

No part of this publication may be reproduced, stored in a retrieval system, or transmitted in any form or by any means, electronic, mechanical, photocopying, recording, or otherwise, without the prior written permission of Seiko Epson Corporation. No patent liability is assumed with respect to the use of the information contained herein. Neither is any liability assumed for damages resulting from the use of the information herein. The information contained herein is designed only for use with this Epson product. Epson is not responsible for any use of this information as applied to other products.

Neither Seiko Epson Corporation nor its affiliates shall be liable to the purchaser of this product or third parties for damages, losses, costs, or expenses incurred by the purchaser or third parties as a result of accident, misuse, or abuse of this product or unauthorized modifications, repairs, or alterations to this product, or (excluding the U.S.) failure to strictly comply with Seiko Epson Corporation's operating and maintenance instructions.

Seiko Epson Corporation and its affiliates shall not be liable for any damages or problems arising from the use of any options or any consumable products other than those designated as Original Epson Products or Epson Approved Products by Seiko Epson Corporation.

Seiko Epson Corporation shall not be held liable for any damage resulting from electromagnetic interference that occurs from the use of any interface cables other than those designated as Epson Approved Products by Seiko Epson Corporation.

© 2022 Seiko Epson Corporation

The contents of this manual and the specifications of this product are subject to change without notice.

Trademarks

- ❑ EPSON® is a registered trademark, and EPSON EXCEED YOUR VISION or EXCEED YOUR VISION is a trademark of Seiko Epson Corporation.
- ❑ PRINT Image Matching™ and the PRINT Image Matching logo are trademarks of Seiko Epson Corporation. Copyright © 2001 Seiko Epson Corporation. All rights reserved.
- ❑ Epson Scan 2 software is based in part on the work of the Independent JPEG Group.
- ❑ libtiff

Copyright © 1988-1997 Sam Leffler

Copyright © 1991-1997 Silicon Graphics, Inc.

Permission to use, copy, modify, distribute, and sell this software and its documentation for any purpose is hereby granted without fee, provided that (i) the above copyright notices and this permission notice appear in all copies of the software and related documentation, and (ii) the names of Sam Leffler and Silicon Graphics may not be used in any advertising or publicity relating to the software without the specific, prior written permission of Sam Leffler and Silicon Graphics.

THE SOFTWARE IS PROVIDED "AS-IS" AND WITHOUT WARRANTY OF ANY KIND, EXPRESS, IMPLIED OR OTHERWISE, INCLUDING WITHOUT LIMITATION, ANY WARRANTY OF MERCHANTABILITY OR FITNESS FOR A PARTICULAR PURPOSE.

IN NO EVENT SHALL SAM LEFFLER OR SILICON GRAPHICS BE LIABLE FOR ANY SPECIAL, INCIDENTAL, INDIRECT OR CONSEQUENTIAL DAMAGES OF ANY KIND, OR ANY DAMAGES WHATSOEVER RESULTING FROM LOSS OF USE, DATA OR PROFITS, WHETHER OR NOT ADVISED OF THE POSSIBILITY OF DAMAGE, AND ON ANY THEORY OF LIABILITY, ARISING OUT OF OR IN CONNECTION WITH THE USE OR PERFORMANCE OF THIS SOFTWARE.

Appendix

- ❑ SDXC Logo is a trademark of SD-3C, LLC.



- ❑ QR Code is a registered trademark of DENSO WAVE INCORPORATED in Japan and other countries.
- ❑ Intel® is a registered trademark of Intel Corporation.
- ❑ Microsoft®, Windows®, Windows Server®, and Windows Vista® are registered trademarks of Microsoft Corporation.
- ❑ Apple, Mac, macOS, OS X, Bonjour, ColorSync, Safari, AirPrint, iPad, iPhone, iPod touch, and iTunes are trademarks of Apple Inc., registered in the U.S. and other countries.
- ❑ Use of the Works with Apple badge means that an accessory has been designed to work specifically with the technology identified in the badge and has been certified by the developer to meet Apple performance standards.
- ❑ Google Cloud Print, Chrome, Chrome OS, Google Play and Android are trademarks of Google Inc.
- ❑ Adobe and Adobe Reader are either registered trademarks or trademarks of Adobe Systems Incorporated in the United States and/or other countries.
- ❑ General Notice: Other product names used herein are for identification purposes only and may be trademarks of their respective owners. Epson disclaims any and all rights in those marks.

Where to Get Help

Technical Support Web Site

If you need further help, visit the Epson support website shown below. Select your country or region and go to the support section of your local Epson website. The latest drivers, FAQs, manuals, or other downloadables are also available from the site.

<http://support.epson.net/>

<http://www.epson.eu/Support> (Europe)

If your Epson product is not operating properly and you cannot solve the problem, contact Epson support services for assistance.

Contacting Epson Support

Before Contacting Epson

If your Epson product is not operating properly and you cannot solve the problem using the troubleshooting information in your product manuals, contact Epson support services for assistance. If Epson support for your area is not listed below, contact the dealer where you purchased your product.

Epson support will be able to help you much more quickly if you give them the following information:

Appendix

- Product serial number
(The serial number label is usually on the back of the product.)
- Product model
- Product software version
(Click **About**, **Version Info**, or a similar button in the product software.)
- Brand and model of your computer
- Your computer operating system name and version
- Names and versions of the software applications you normally use with your product

Note:

Depending on the product, network settings may be stored in the product's memory. Due to breakdown or repair of a product, settings may be lost. Epson shall not be responsible for the loss of any data, for backing up or recovering settings even during a warranty period. We recommend that you make your own backup data or take notes.

Help for Users in Europe

Check your Pan-European Warranty Document for information on how to contact Epson support.

Help for Users in Taiwan

Contacts for information, support, and services are:

World Wide Web

<http://www.epson.com.tw>

Information on product specifications, drivers for download, and products enquiry are available.

Epson HelpDesk

Phone: +886-2-2165-3138

Our HelpDesk team can help you with the following over the phone:

- Sales enquiries and product information
- Product usage questions or problems
- Enquiries on repair service and warranty

Repair service center:

<http://www.tekcare.com.tw/branchMap.page>

TekCare corporation is an authorized service center for Epson Taiwan Technology & Trading Ltd.

Help for Users in Australia

Epson Australia wishes to provide you with a high level of customer service. In addition to your product manuals, we provide the following sources for obtaining information:

Appendix

Internet URL

<http://www.epson.com.au>

Access the Epson Australia World Wide Web pages. Worth taking your modem here for the occasional surf! The site provides a download area for drivers, Epson contact points, new product information and technical support (e-mail).

Epson Helpdesk

Phone: 1300-361-054

Epson Helpdesk is provided as a final backup to make sure our clients have access to advice. Operators on the Helpdesk can aid you in installing, configuring and operating your Epson product. Our Pre-sales Helpdesk staff can provide literature on new Epson products and advise where the nearest dealer or service agent is located. Many types of queries are answered here.

We encourage you to have all the relevant information on hand when you ring. The more information you prepare, the faster we can help solve the problem. This information includes your Epson product manuals, type of computer, operating system, application programs, and any information you feel is required.

Transportation of Product

Epson recommends retaining product packaging for future transportation. Securing the ink tank with tape and keeping the product upright is also recommended.

Help for Users in New Zealand

Epson New Zealand wishes to provide you with a high level of customer service. In addition to your product documentation, we provide the following sources for obtaining information:

Internet URL

<http://www.epson.co.nz>

Access the Epson New Zealand World Wide Web pages. Worth taking your modem here for the occasional surf! The site provides a download area for drivers, Epson contact points, new product information and technical support (e-mail).

Epson Helpdesk

Phone: 0800 237 766

Epson Helpdesk is provided as a final backup to make sure our clients have access to advice. Operators on the Helpdesk can aid you in installing, configuring and operating your Epson product. Our Pre-sales Helpdesk staff can provide literature on new Epson products and advise where the nearest dealer or service agent is located. Many types of queries are answered here.

We encourage you to have all the relevant information on hand when you ring. The more information you prepare, the faster we can help solve the problem. This information includes your Epson product documentation, type of computer, operating system, application programs, and any information you feel is required.

Transportation of Product

Epson recommends retaining product packaging for future transportation. Securing the ink tank with tape and keeping the product upright is also recommended.

Appendix

Help for Users in Singapore

Sources of information, support, and services available from Epson Singapore are:

World Wide Web

<http://www.epson.com.sg>

Information on product specifications, drivers for download, Frequently Asked Questions (FAQ), Sales Enquiries, and Technical Support via e-mail are available.

Epson HelpDesk

Toll Free: 800-120-5564

Our HelpDesk team can help you with the following over the phone:

- Sales enquiries and product information
- Product usage questions or problem troubleshooting
- Enquiries on repair service and warranty

Help for Users in Thailand

Contacts for information, support, and services are:

World Wide Web

<http://www.epson.co.th>

Information on product specifications, drivers for download, Frequently Asked Questions (FAQ), and e-mail are available.

Epson Call Centre

Phone: 66-2460-9699

Email: support@eth.epson.co.th

Our Call Centre team can help you with the following over the phone:

- Sales enquiries and product information
- Product usage questions or problems
- Enquiries on repair service and warranty

Help for Users in Vietnam

Contacts for information, support, and services are:

Epson Service Center

65 Truong Dinh Street, District 1, Ho Chi Minh City, Vietnam.

Phone(Ho Chi Minh City): 84-8-3823-9239, 84-8-3825-6234

29 Tue Tinh, Quan Hai Ba Trung, Hanoi City, Vietnam

Phone(Hanoi City): 84-4-3978-4785, 84-4-3978-4775

Appendix

Help for Users in Indonesia

Contacts for information, support, and services are:

World Wide Web

<http://www.epson.co.id>

- Information on product specifications, drivers for download
- Frequently Asked Questions (FAQ), Sales Enquiries, questions through e-mail

Epson Hotline

Phone: +62-1500-766

Fax: +62-21-808-66-799

Our Hotline team can help you with the following over the phone or fax:

- Sales enquiries and product information
- Technical support

Epson Service Center

Province	Company Name	Address	Phone E-mail
DKI JAKARTA	ESS JAKARTA MANGGADUA	Ruko Mall Mangga Dua No. 48 Jl. Arteri Mangga Dua, Jakarta Utara - DKI JAKARTA	(+6221) 62301104 jkt-admin@epson-indonesia.co.id
NORTH SUMATERA	ESC MEDAN	Jl. Bambu 2 Komplek Graha Niaga Nomor A-4, Medan - North Sumatera	(+6261) 42066090 / 42066091 mdn-adm@epson-indonesia.co.id
WEST JAWA	ESC BANDUNG	Jl. Cihampelas No. 48 A Bandung Jawa Barat 40116	(+6222) 4207033 bdg-admin@epson- indonesia.co.id
DI YOGYAKARTA	ESC YOGYAKARTA	YAP Square, Block A No. 6 Jl. C Simanjutak Yogyakarta - DIY	(+62274) 581065 ygy-admin@epson-indonesia.co.id
EAST JAWA	ESC SURABAYA	Hitech Mall Lt. 2 Block A No. 24 Jl. Kusuma Bangsa No. 116 - 118 Surabaya - JATIM	(+6231) 5355035 sby-admin@epson-indonesia.co.id
SOUTH SULAWESI	ESC MAKASSAR	Jl. Cendrawasih NO. 3A, kunjung mae, mariso, MAKASSAR - SULSEL 90125	(+62411) 8911071 mksr-admin@epson- indonesia.co.id
WEST KALIMANTAN	ESC PONTIANAK	Komp. A yani Sentra Bisnis G33, Jl. Ahmad Yani - Pontianak Kalimantan Barat	(+62561) 735507 / 767049 pontianak-admin@epson- indonesia.co.id
RIAU	ESC PEKANBARU	Jl. Tuanku Tambusai No.459A Pekanbaru Riau	(+62761) 8524695 pkb-admin@epson- indonesia.co.id

Appendix

Province	Company Name	Address	Phone E-mail
DKI JAKARTA	ESS JAKARTA SUDIRMAN	Wisma Keiai Lt. 1 Jl. Jenderal Sudirman Kav. 3 Jakarta Pusat - DKI JAKARTA 10220	(+6221) 5724335 ess@epson-indonesia.co.id
EAST JAWA	ESS SURABAYA	Ruko Surya Inti Jl. Jawa No 2-4 Kav. 29 Surabaya - Jawa Timur	(+6231) 5014949 esssby@epson-indonesia.co.id
BANTEN	ESS SERPONG	Ruko Mall WTC Matahari No. 953, Serpong- Banten	(+6221) 53167051 / 53167052 esstag@epson-indonesia.co.id
CENTRAL JAWA	ESS SEMARANG	Komplek Ruko Metro Plaza Block C20 Jl. MT Haryono No 970 Semarang - JAWA TENGAH	(+6224) 8313807 / 8417935 esssmg@epson-indonesia.co.id
EAST KALIMANTAN	ESC SAMARINDA	Jl. KH. Wahid Hasyim (M. Yamin) Kelurahan Sempaja Selatan Kecamatan Samarinda UTARA - SAMARINDA - KALTIM	(+62541) 7272904 escsmd@epson-indonesia.co.id
SOUTH SUMATERA	ESC PALEMBANG	Jl. H.M Rasyid Nawawi No. 249 Kelurahan 9 Ilir Palembang Sumatera Selatan	(+62711) 311330 escplg@epson-indonesia.co.id
EAST JAVA	ESC JEMBER	Jl. Panglima Besar Sudirman Ruko no.1D Jember-Jawa Timur (Depan Balai Penelitian & Pengolahan Kakao)	(+62331) 488373 / 486468 jmr-admin@epson-indonesia.co.id
NORTH SULAWESI	ESC MANADO	Tekno Megamall Lt LG 11 TK 21, Kawasan Megamas Boulevard, Jl Piere Tendean, Manado - SULUT 95111	(+62431) 8890996 MND-ADMIN@EPSON- INDONESIA.CO.ID

For other cities not listed here, call the Hot Line: 08071137766.

Help for Users in Hong Kong

To obtain technical support as well as other after-sales services, users are welcome to contact Epson Hong Kong Limited.

Internet Home Page

<http://www.epson.com.hk>

Epson Hong Kong has established a local home page in both Chinese and English on the Internet to provide users with the following information:

- Product information
- Answers to Frequently Asked Questions (FAQs)
- Latest versions of Epson product drivers

Technical Support Hotline

You can also contact our technical staff at the following telephone and fax numbers:

Phone: 852-2827-8911

Fax: 852-2827-4383

Help for Users in Malaysia

Contacts for information, support, and services are:

World Wide Web

<http://www.epson.com.my>

- Information on product specifications, drivers for download
- Frequently Asked Questions (FAQ), Sales Enquiries, questions through e-mail

Epson Call Centre

Phone: +60 1800-8-17349

- Sales enquiries and product information
- Product usage questions or problems
- Enquiries on repair services and warranty

Head Office

Phone: 603-56288288

Fax: 603-5628 8388/603-5621 2088

Help for Users in India

Contacts for information, support, and services are:

World Wide Web

<http://www.epson.co.in>

Information on product specifications, drivers for download, and products enquiry are available.

Helpline

- Service, product information, and ordering consumables (BSNL Lines)
 - Toll-free number: 18004250011
 - Accessible 9am to 6pm, Monday through Saturday (Except public holidays)
- Service (CDMA & Mobile Users)
 - Toll-free number: 186030001600
 - Accessible 9am to 6pm, Monday through Saturday (Except public holidays)

Help for Users in the Philippines

To obtain technical support as well as other after sales services, users are welcome to contact the Epson Philippines Corporation at the telephone, fax numbers and e-mail address below:

World Wide Web

<http://www.epson.com.ph>

Appendix

Information on product specifications, drivers for download, Frequently Asked Questions (FAQ), and E-mail Enquiries are available.

Epson Philippines Customer Care

Toll Free: (PLDT) 1-800-1069-37766

Toll Free: (Digital) 1-800-3-0037766

Metro Manila: (+632)441-9030

Web Site: <https://www.epson.com.ph/contact>

E-mail: customercare@epc.epson.com.ph

Accessible 9am to 6pm, Monday through Saturday (Except public holidays)

Our Customer Care team can help you with the following over the phone:

- Sales enquiries and product information
- Product usage questions or problems
- Enquiries on repair service and warranty

Epson Philippines Corporation

Trunk Line: +632-706-2609

Fax: +632-706-2663