

EPSON

Water Recycling Unit (C12C939921) User's Manual

M00163301 EN
Rev.B

Original instructions

Cautions and Trademarks

Cautions and Trademarks

Cautions

- ❑ No part of this document may be reproduced, stored in a retrieval system, or transmitted in any form or by any means, electronic, mechanical, photocopying, recording, or otherwise, without the prior written permission of Seiko Epson Corporation.
- ❑ The contents of this document are subject to change without notice. Please contact us for the latest information.
- ❑ While every precaution has been taken in the preparation of this document, Seiko Epson Corporation assumes no responsibility for errors or omissions.
- ❑ Neither is any liability assumed for damages resulting from the use of the information contained herein.
- ❑ Neither Seiko Epson Corporation nor its affiliates shall be liable to the purchaser of this product or third parties for damages, losses, costs, or expenses incurred by the purchaser or third parties as a result of: accident, misuse, or abuse of this product or unauthorized modifications, repairs, or alterations to this product, or (excluding the U.S.) failure to strictly comply with Seiko Epson Corporation's operating and maintenance instructions.
- ❑ Seiko Epson Corporation shall not be liable against any damages or problems arising from the use of any options or any consumable products other than those designated as Original EPSON Products or EPSON Approved Products by Seiko Epson Corporation.

Trademarks

All trademarks are the property of their respective owners and used for identification purpose only.

Product Overview

This product adds a water recycling system to Epson's inkjet textile printer. It circulates cleaning water used by the belt cleaning unit to remove lint. The ink density sensor is used to replace this water at the appropriate time. The ink density sensor allows you to circulate and use the cleaning water as long as possible, making more efficient use of the cleaning water than before.

Before using this product, be sure to receive safety and operational training from your dealer or Epson Support.



©Seiko Epson Corporation 2024-2025

About This Manual

About This Manual

Symbols Regarding General Information

This manual uses the following symbols.

 Important:	This symbol indicates information the user must obey when using this machine. Mishandling the machine by ignoring this symbol can result in product failures or malfunctions.
Note:	This symbol indicates a supplementary explanation or additional information that the user should know.
	This symbol indicates pages to reference with related information.
Printer Settings	Text that is displayed on the printer's control panel or on your computer is displayed in bold.

Illustrations

Note that illustrations in each manual may differ from the model you are using.

Manual Organization

The manuals for the product are organized as shown below.

You can view the PDF manuals using Adobe Acrobat Reader or Preview (Mac).

Safety Precautions (Manual)	This manual explains the safety precautions. Make sure you read this manual to perform operations safely.
User's Manual (this manual)	This manual explains the basics of using this product and how to troubleshoot problems.

The latest versions of the manuals are available from the epson.sn website. Enter epson.sn into your Internet browser, select your printer model, and then download the "User's Manual" for the "Water Recycling Unit (C12C939921)".

For information on how to operate the printer, see the manual supplied with the printer.

Contents

Cautions and Trademarks

Cautions.	2
Trademarks.	2
Product Overview.	2

About This Manual

Symbols Regarding General Information.	3
Illustrations.	3
Manual Organization.	3

Before Use

Meaning of Symbols.	5
Symbols Regarding Safety.	5
Printer Parts.	6
Front.	6
Inside Front.	7
Control Panel.	8
Rear.	11

Basic Operations

Workflow Before Starting Work.	12
Pre-work Inspection of the Printer.	12
Check the Status of the Product.	12
Cleaning the Lint Trap.	13
Workflow at the End of Work.	16
Check the Status of the Product.	16
End-of-day Inspection of the Printer.	16

Maintenance

When to Perform Various Maintenance Operations.	18
Cleaning the Lint Trap.	18
Cleaning Inside the Tank.	18
Disposal of Used Consumables.	22

Problem Solver

Appendix

Specifications.	27
-------------------------	----

Before Use

Before Use







This chapter shows the meaning of symbols used in this manual and on this product, as well as the name and function of each part.

IMPORTANT: Before using this product, make sure you read these instructions and the safety instructions in the *Safety Precautions* guide.

Meaning of Symbols

This manual and product use the following symbols to ensure the product is used safely and to prevent risks and damage. The symbols have the meanings described below.

Symbols Regarding Safety

 Warning:	This symbol indicates content where mishandling the machine by ignoring this symbol can result in death or serious injuries.
 Caution:	This symbol indicates content where mishandling the machine by ignoring this symbol can result in injury or property damage.
	Indicates actions you must not do (prohibited actions).
	Indicates things you must do (instructions, actions).
	Indicates that disassembly is prohibited.
	Indicates that touching is prohibited.
	Indicates that flames are strictly prohibited.

Before Use

Printer Parts

Front

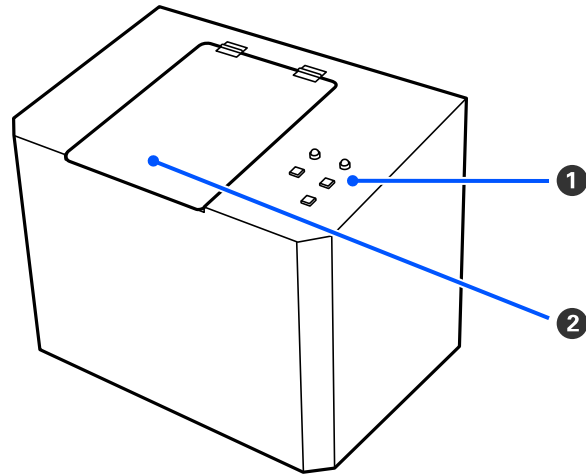

1 Control panel

 ["Control Panel" on page 8](#)

2 Maintenance cover

You can look through this cover and see the cleaning water flowing into the product during operation.

Open this to perform maintenance, such as cleaning the inside of the tank.

Before Use

Inside Front

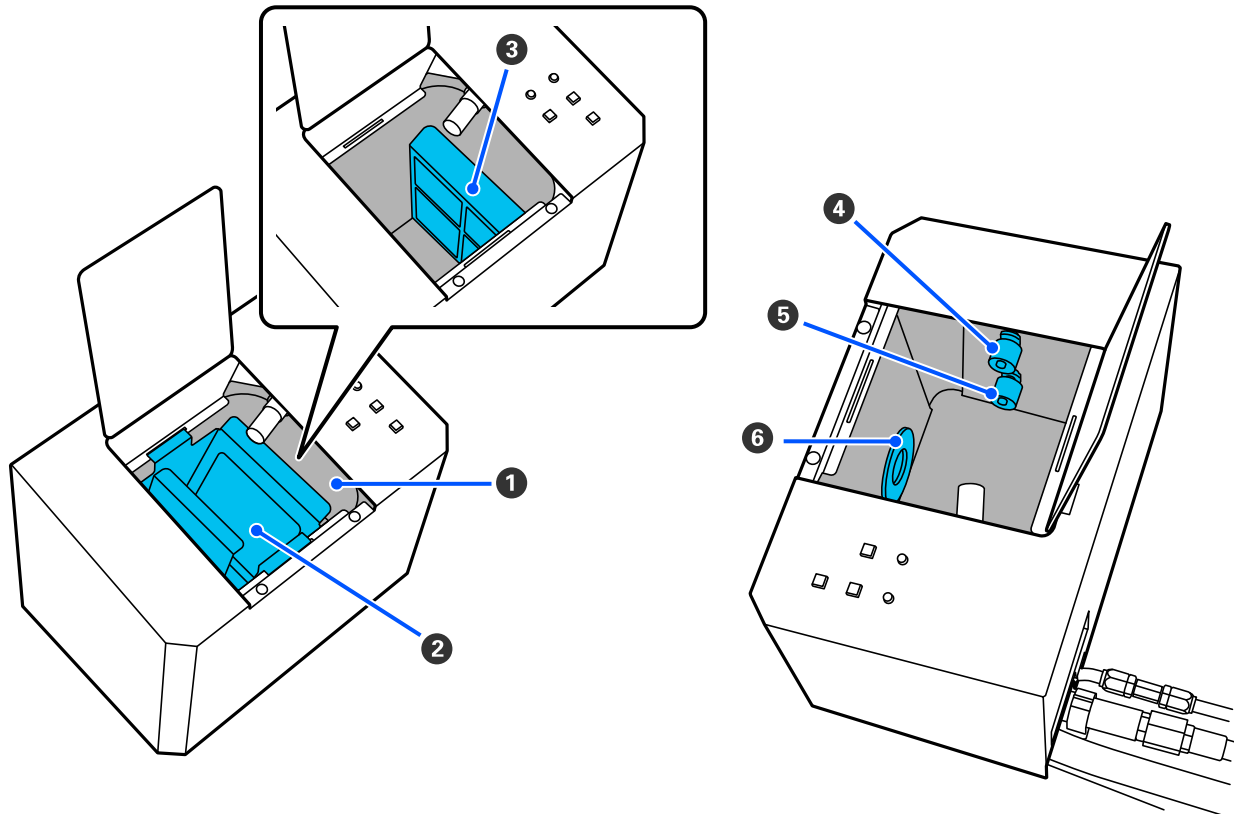

1 Tank
Collects the cleaning water that comes from the printer's belt cleaning tank.

2 Lint trap
Collects the lint that comes from the printer's belt cleaning tank.

Clean this when too much lint has accumulated.

 [“Cleaning the Lint Trap” on page 13](#)

3 Lint filter
Prevents lint from entering the printer's belt cleaning tank.

Clean this when too much lint has accumulated.

 [“Cleaning Inside the Tank” on page 18](#)

4 Max. water level sensor
Detects when the cleaning water in the tank has reached the maximum limit.

5 Min. water level sensor
Detects when the cleaning water in the tank has reached the minimum limit.

Before Use

6 Ink density sensor

Detects the ink density in the cleaning water.

Control Panel

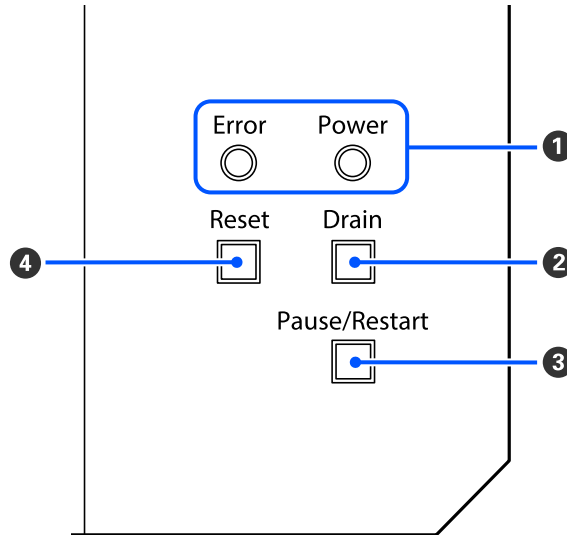

1 Status lights

You can check the product's operating status and error status.

[👉 “Understanding the status lights” on page 8](#)

2 Drain button

Press when cleaning inside the tank. The cleaning water in the tank is drained into the printer's belt cleaning tank, causing the water level in the tank to decrease.

[👉 “Cleaning Inside the Tank” on page 18](#)



3 Pause/Restart button

Press to pause the product. Press the button when the product is paused to restart.













4 Reset button

Press and hold for at least three seconds to reset the product.









Understanding the status lights

Error	Power	Description	Solution
 Off	 Off	The product is off.	Turn on the printer. If the printer does not start when you turn it on, contact your dealer or Epson Support.

Before Use

Error	Power	Description	Solution
 Off	 On	The system is starting up or operating.	-
 Off	 Flashing	The product is paused.	After performing any necessary procedures, press the Pause/Restart button.
 Off	 Flashing quickly twice, then off for one second	Clean water is being supplied to the tank because the cleaning water level in the tank is too low or the ink density in the cleaning water is too high.	-
 Off	 Flashing quickly	The cleaning water is being drained from the tank.	Wait until draining is complete. When draining is complete, the product will pause.
 Flashing quickly three times, then off for one second	 On	The cleaning water in the tank has reached its maximum limit.	<p>Check the water level in the tank. Depending on the water level, perform the following operations.</p> <ul style="list-style-type: none"> <input type="checkbox"/> When the water level has reached the max. water level sensor <ul style="list-style-type: none"> 1. Check if the drainage path is blocked by a kink in the drainage connection hose or any other obstruction. Once you have cleared the blockage and the tank's water level has dropped, press and hold the Reset button for at least three seconds. If the water level does not drop, use a commercially available pump or similar device to drain the water manually. 2. Clean inside the tank.  "Cleaning Inside the Tank" on page 18 <input type="checkbox"/> When the water level has not reached the max. water level sensor <ul style="list-style-type: none"> There may be lint or other debris stuck to the sensor. 1. Check if the drainage path is blocked by a kink in the drainage hose or any other obstruction, then press and hold the Reset button for at least three seconds. 2. Clean inside the tank.  "Cleaning Inside the Tank" on page 18 <p>If the problem continues to occur, contact your dealer or Epson Support.</p>

Before Use

Error	Power	Description	Solution
 Flashing quickly four times, then off for one second	 On	Supplying water to the tank has not been completed.	Perform the following operations. <ul style="list-style-type: none"> <input type="checkbox"/> Open the manual valve  "Problem Solver" on page 23 Steps 1, 2 <input type="checkbox"/> Close the drain valve on the printer <input type="checkbox"/> If water leaks from the printer's water pipes, tighten the joints. After performing the operations above, press and hold the Reset button for at least three seconds. If the problem continues to occur, contact your dealer or Epson Support.
 Flashing quickly five times, then off for one second	 On	Draining the tank has not been completed.	Perform the following operations. <ul style="list-style-type: none"> <input type="checkbox"/> Press and hold the Reset button for at least three seconds <input type="checkbox"/> Clean inside the tank  "Cleaning Inside the Tank" on page 18 If the problem continues to occur, contact your dealer or Epson Support.
 Flashing	 Flashing	A system error has occurred.	Press and hold the Reset button for at least three seconds to restart the product. If restarting does not solve the issue, contact your dealer or Epson Support.

Note:

See the following if you want to continue using the printer without this product.

 ["Problem Solver" on page 23](#)

Before Use

Rear

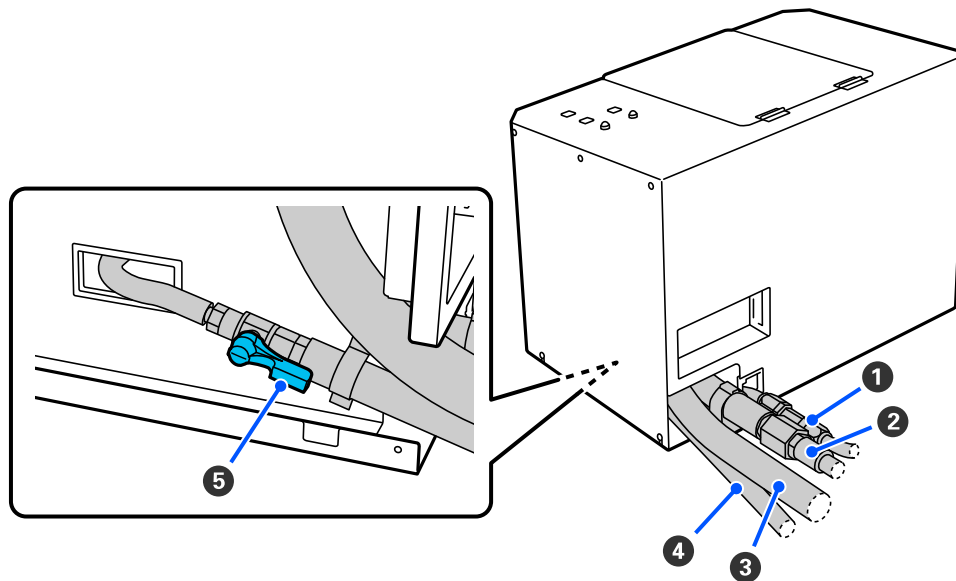

1 Water supply hose

Supplies clean water to the product.

2 Drainage hose

Releases cleaning water discharged from the product.

3 Belt cleaning tank drainage hose

Releases cleaning water from the printer's belt cleaning tank to this product.

4 Belt cleaning tank water supply hose

Supplies cleaning water from the product to the printer's belt cleaning tank.

5 Manual valve

Allows you to open and close the supply path from the product to the printer's belt cleaning tank. Use this if there is an issue with the product.

To operate this, you need to remove the cover screwed on to the right side of the product.

Basic Operations

Basic Operations

This chapter explains the workflow from starting the product to the end of work.

Workflow before starting work	1. Pre-work inspection of the printer
	2. Check the status of the product
	3. Clean the Lint trap



Workflow at the end of work	1. Check the status of the product
	2. End-of-day inspection of the printer

Note:

For information on how to operate the printer, see the manual supplied with the printer.

Workflow Before Starting Work

Pre-work Inspection of the Printer

Conduct a pre-work inspection of the printer, exhaust equipment, and so on, and turn on the printer.

This product is automatically turned on when the printer is turned on.

If water is leaking from the product, contact your dealer or Epson Support.



Important:

When performing maintenance involving draining the printer's cleaning tank or reapplying glue, press the Pause/Restart button on the product to pause it before starting work. After completing work, press and hold the product's Reset button for at least three seconds to restart operation.

Check the Status of the Product

Look through the maintenance cover to confirm that cleaning water is flowing from the printer's belt cleaning tank to the product.

Basic Operations

If you cannot confirm that liquid is flowing after five minutes of turning on the printer, a malfunction may have occurred. Contact your dealer or Epson Support.

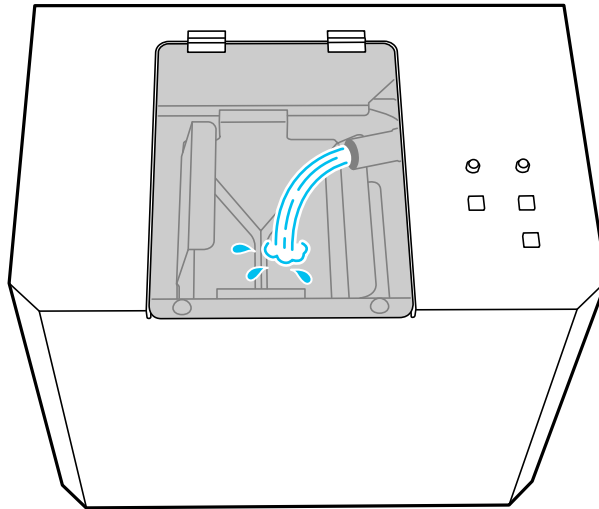

The product regularly checks the ink density in the cleaning water. When the ink density in the cleaning water is too high, clean water is supplied to the product until the ink density decreases.

Cleaning the Lint Trap

Clean the lint trap.

Personal protective equipment	Protective gloves and clothing, eye protection
-------------------------------	--

1

Press the Pause/Restart button.

Wait until the flow of cleaning water into the product has slowed down.

Basic Operations

- 2** Open the maintenance cover.

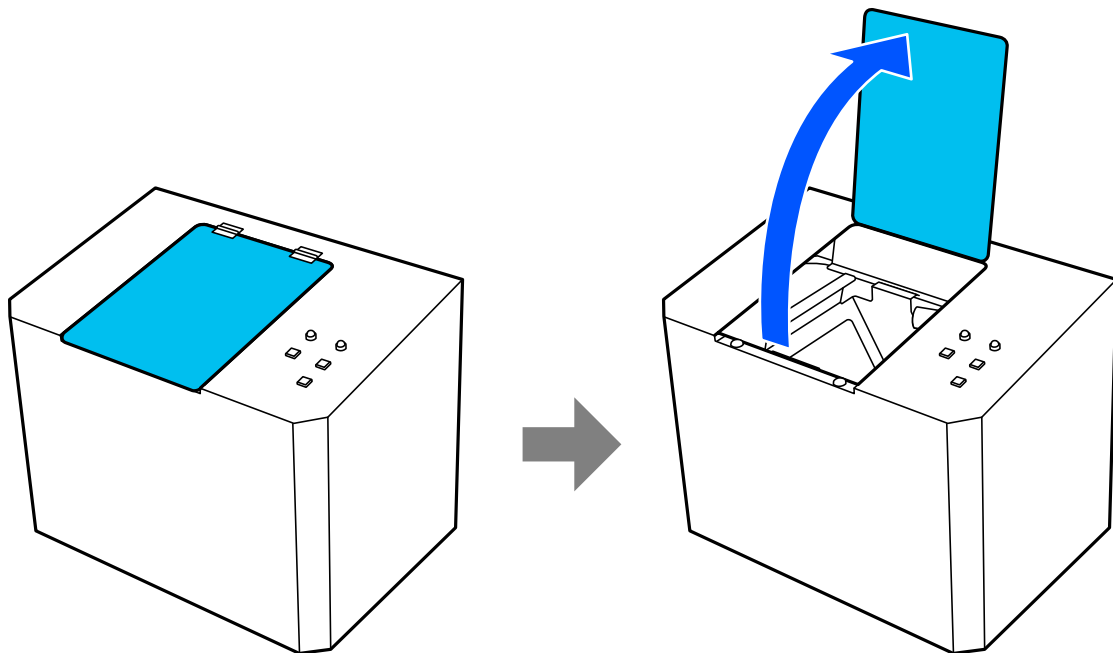

- 3** Remove the lint trap.

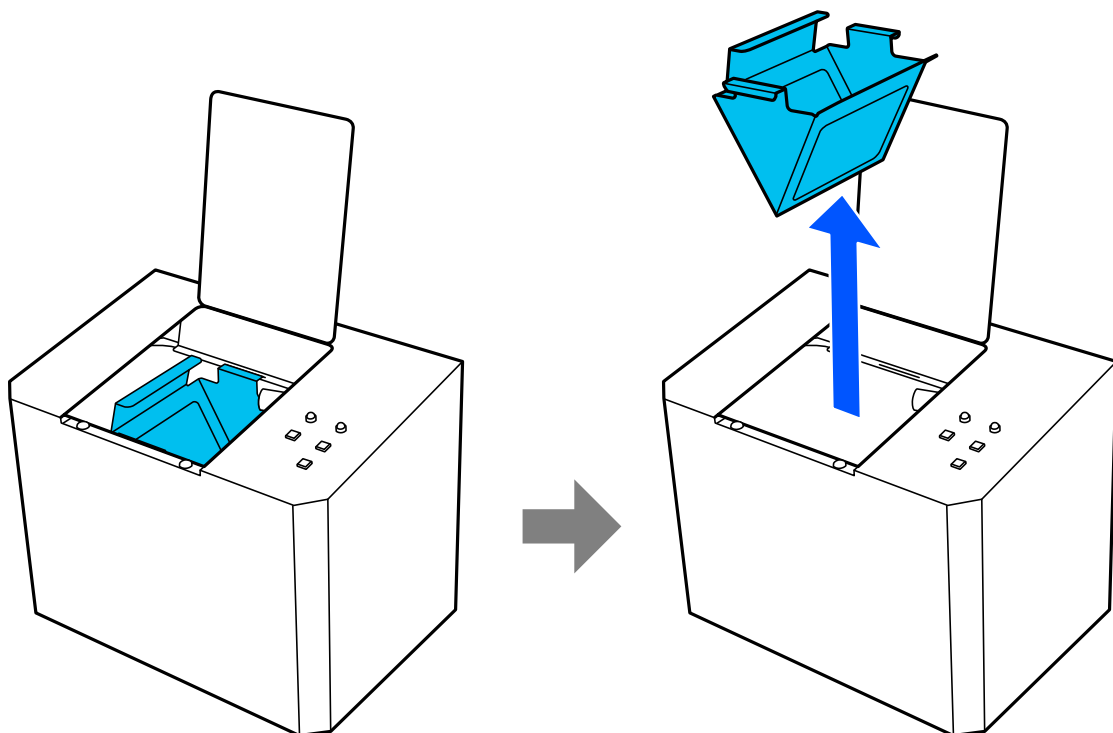

- 4** Use a brush, wipe cloth, or similar item to remove lint and other debris from the lint trap.
If it is very dirty, soak it in a container filled with tap water to remove the dirt.

Basic Operations

Used brushes, wipe cloths, and dirty water are considered industrial waste. Dispose of them in the proper manner for industrial waste.

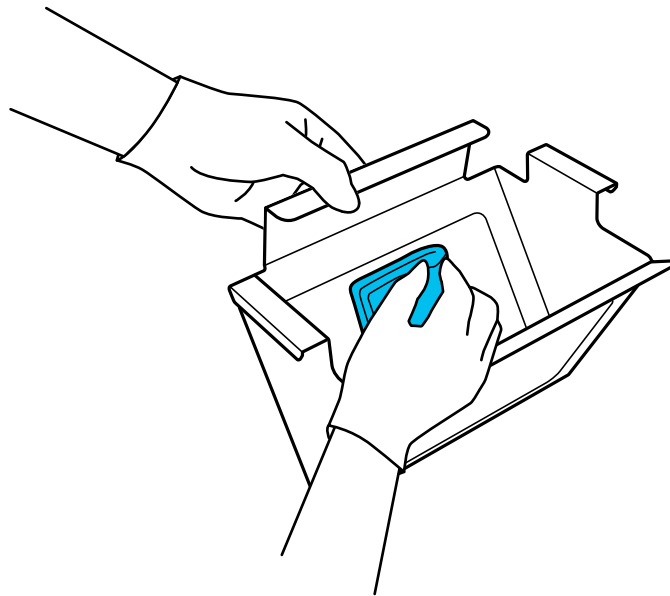

- 5** Return the lint trap to its original position.

Place the hooks of the lint trap over the edges of the product, with the short side at the back and the long side at the front.

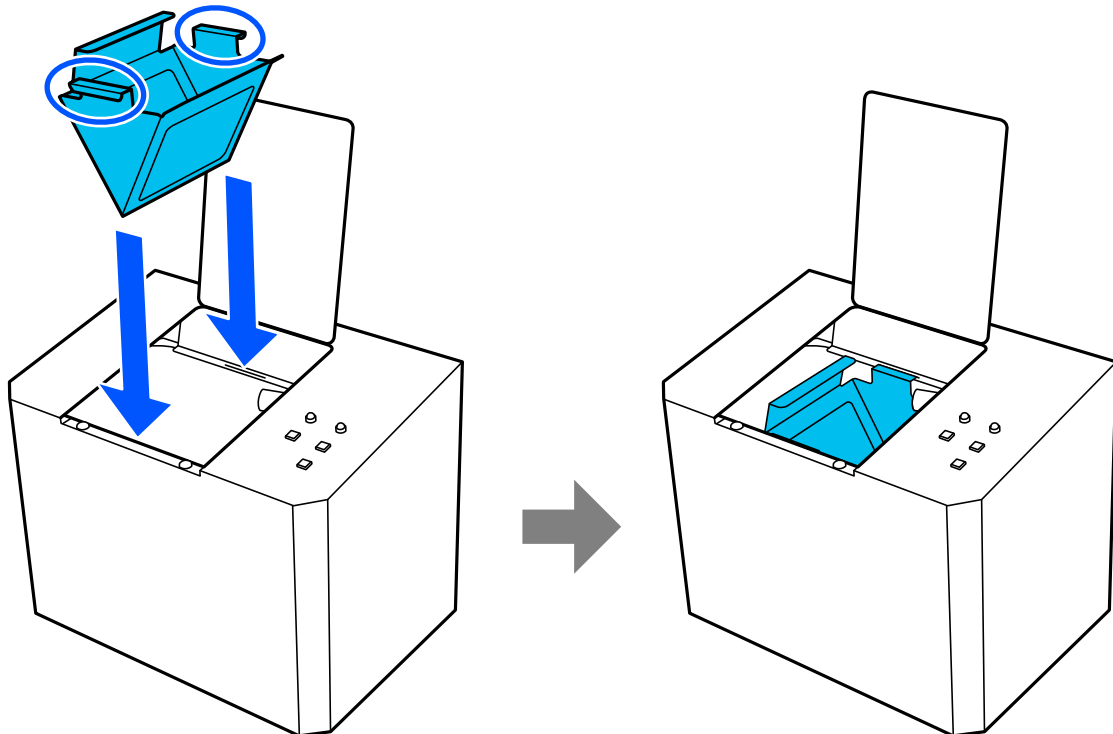

Basic Operations

- 6** Close the maintenance cover.

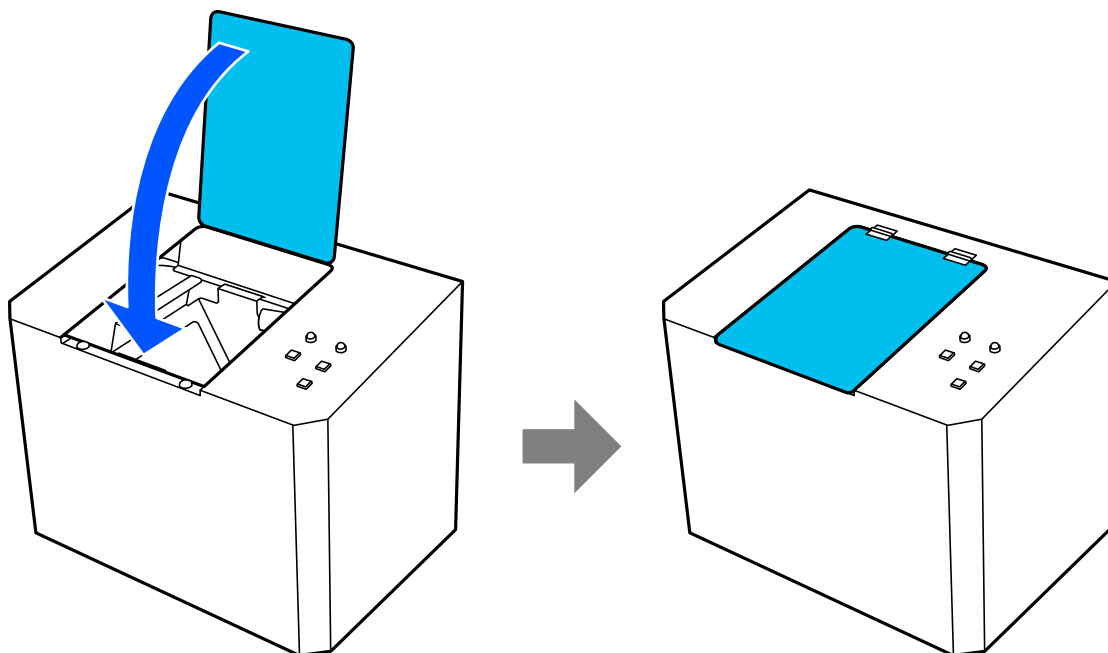

- 7** Press the Pause/Restart button.

The product starts operating again, and the cleaning water flows into it.

Workflow at the End of Work

Check the Status of the Product

Look through the maintenance cover to confirm that cleaning water is flowing from the printer's belt cleaning tank to the product.

Clean the lint trap when too much lint has accumulated.

 [“Cleaning the Lint Trap” on page 13](#)

If the liquid has stopped flowing, check the status lights and take action to solve the error.

 [“Understanding the status lights” on page 8](#)

If water is leaking from the product, contact your dealer or Epson Support.

End-of-day Inspection of the Printer

Conduct an end-of-work inspection, including printer maintenance, and turn off the printer.

This product is automatically turned off when the printer is turned off.

Basic Operations



Important:

When performing maintenance involving draining the printer's cleaning tank or reapplying glue, press the Pause/Restart button on the product to pause it before starting work. After completing work, press and hold the product's Reset button for at least three seconds to restart operation.

Maintenance

Maintenance

This chapter explains the procedures for performing appropriate maintenance.

Note:

For information on how to operate the printer, see the manual supplied with the printer.

When to Perform Various Maintenance Operations

Item	Frequency	Timing
Cleaning the Lint Trap	Everyday	Before starting work
Clean inside the tank	Once every three months	Before starting work

Cleaning the Lint Trap

See the following for details.

 [“Cleaning the Lint Trap” on page 13](#)

Cleaning Inside the Tank

Personal protective equipment	Protective gloves and clothing, eye protection
-------------------------------	--

- 1** Open the drain valve on the printer.
- 2** Press the Drain button on the product.
The Power light flashes quickly, and the cleaning water drains from the tank. When draining is complete, the product will pause.
- 3** Open the maintenance cover and make sure the water level in the tank has dropped to the min. water level sensor.
- 4** Turns off the printer.
The product turns off automatically.

Maintenance

- 5** Remove the lint trap.

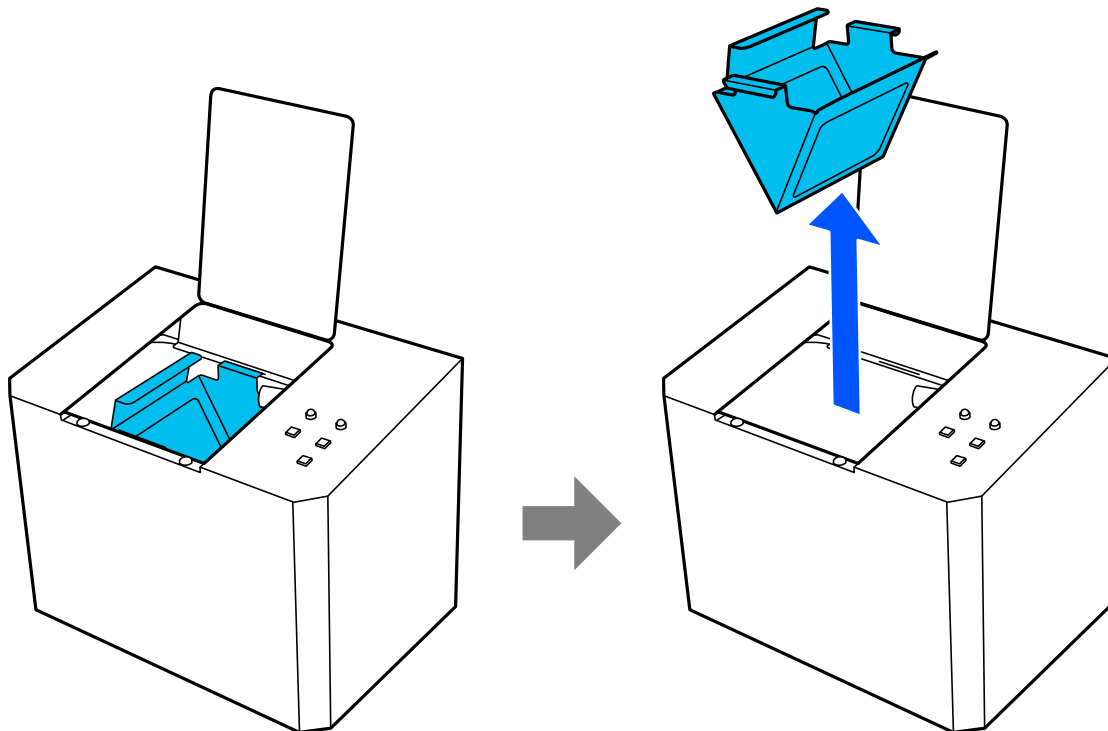

- 6** Use a brush, wipe cloth, or similar item to remove lint and other debris from the lint trap.

If it is very dirty, soak it in a container filled with tap water to remove the dirt.

Used brushes, wipe cloths, and dirty water are considered industrial waste. Dispose of them in the proper manner for industrial waste.

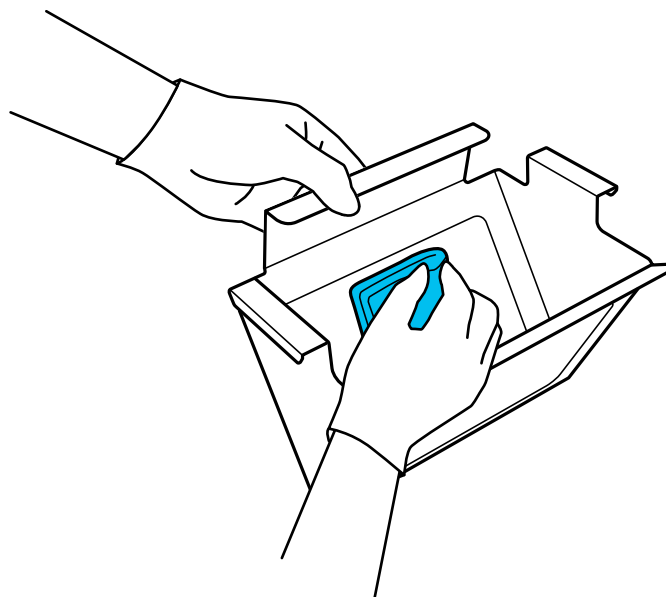

- 7** Remove lint and other debris from the lint filter and from inside the tank.

Remove any dirt with a brush, wipe cloth, or similar item.

Maintenance

Used brushes and wipe cloths are considered industrial waste. Dispose of them in the proper manner for industrial waste.

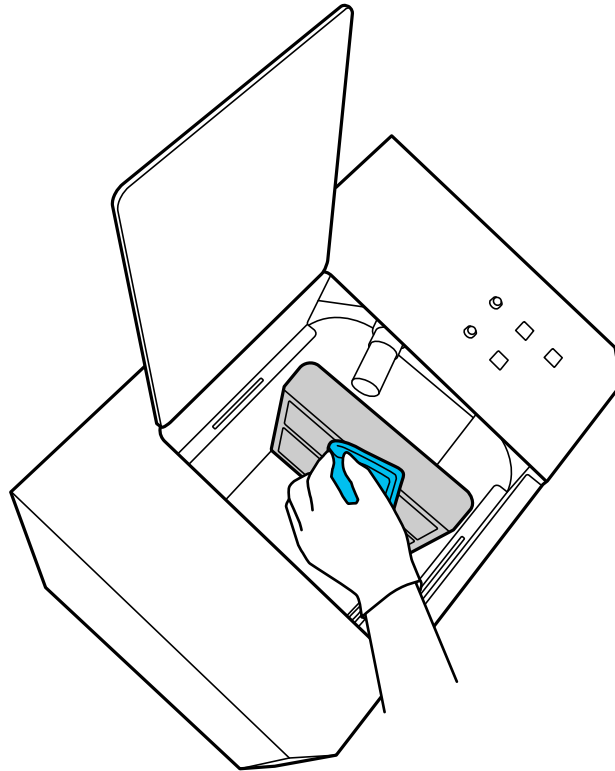

8

Remove any lint or debris from the Min. water level sensor and the Max. water level sensor.

Maintenance

- 9** Return the lint trap to its original position.

Place the hooks of the lint trap over the edges of the product, with the short side at the back and the long side at the front.

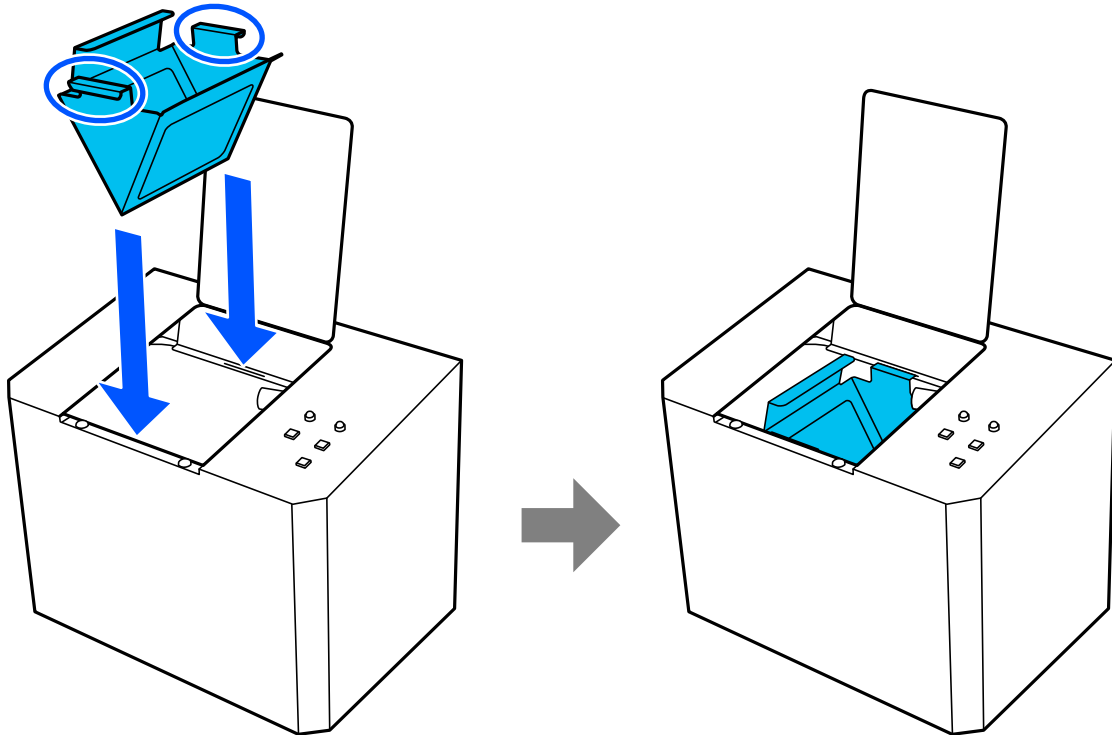

- 10** Close the maintenance cover.

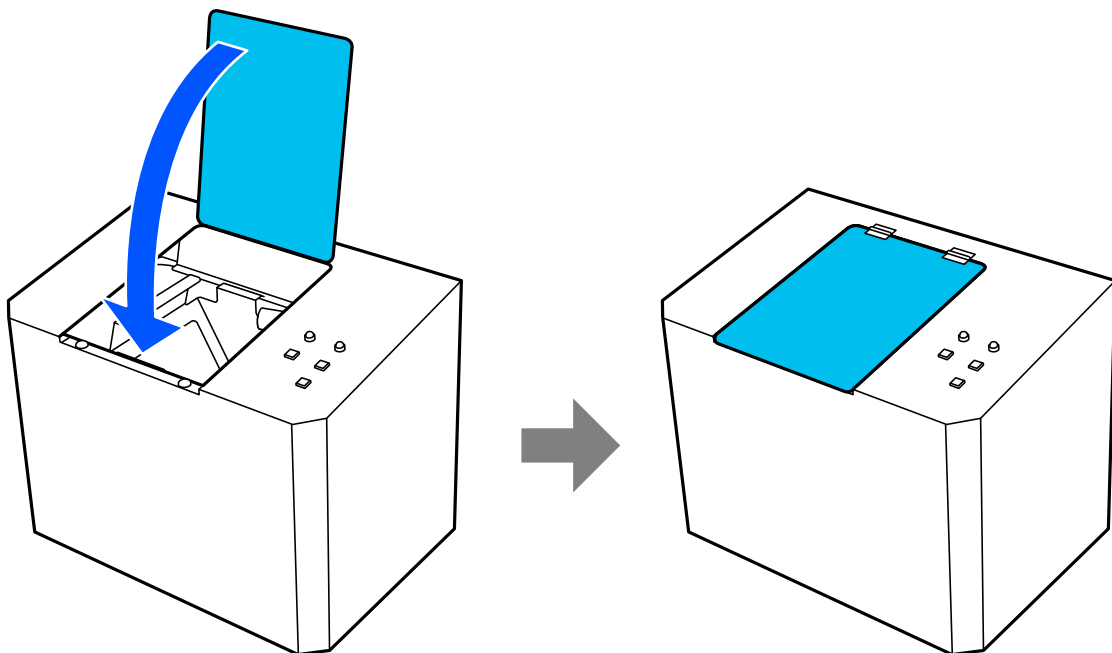

- 11** Close the drain valve on the printer.

Maintenance

12 Turn on the printer.

The product turns on automatically.

13 Make sure cleaning water flows into to the product for at least five seconds.

Clean water is supplied if the product starts with only a small amount of cleaning water in the tank.

Disposal of Used Consumables

Used consumables with ink or cleaning water on them, such as brushes and wipe cloths used for maintenance, are considered industrial waste.

Dispose of items according to local laws and regulations. For example, contract an industrial waste disposal company for disposal. In such cases, submit the "Safety Data Sheet" to the industrial waste disposal company. The Safety Data Sheet can be downloaded from the Epson website.

Problem Solver

Check the status lights if the product does not operate correctly or if any other issues occur.

 [“Understanding the status lights” on page 8](#)

If the issue continues after trying the troubleshooting solutions or if water is leaking from the product, contact your dealer or Epson Support.

Follow the steps below if you want to continue using the printer without this product.

- 1** Remove the top three screws on the right side of the product, and loosen the bottom two screws.

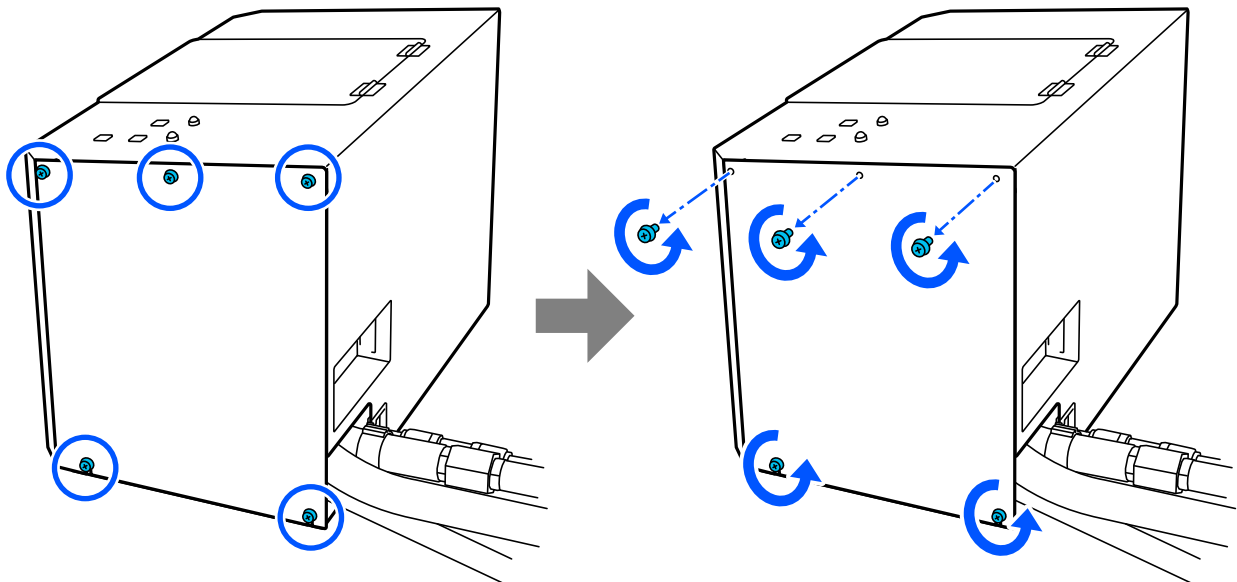

Problem Solver

- 2 Slide the cover up to remove it.

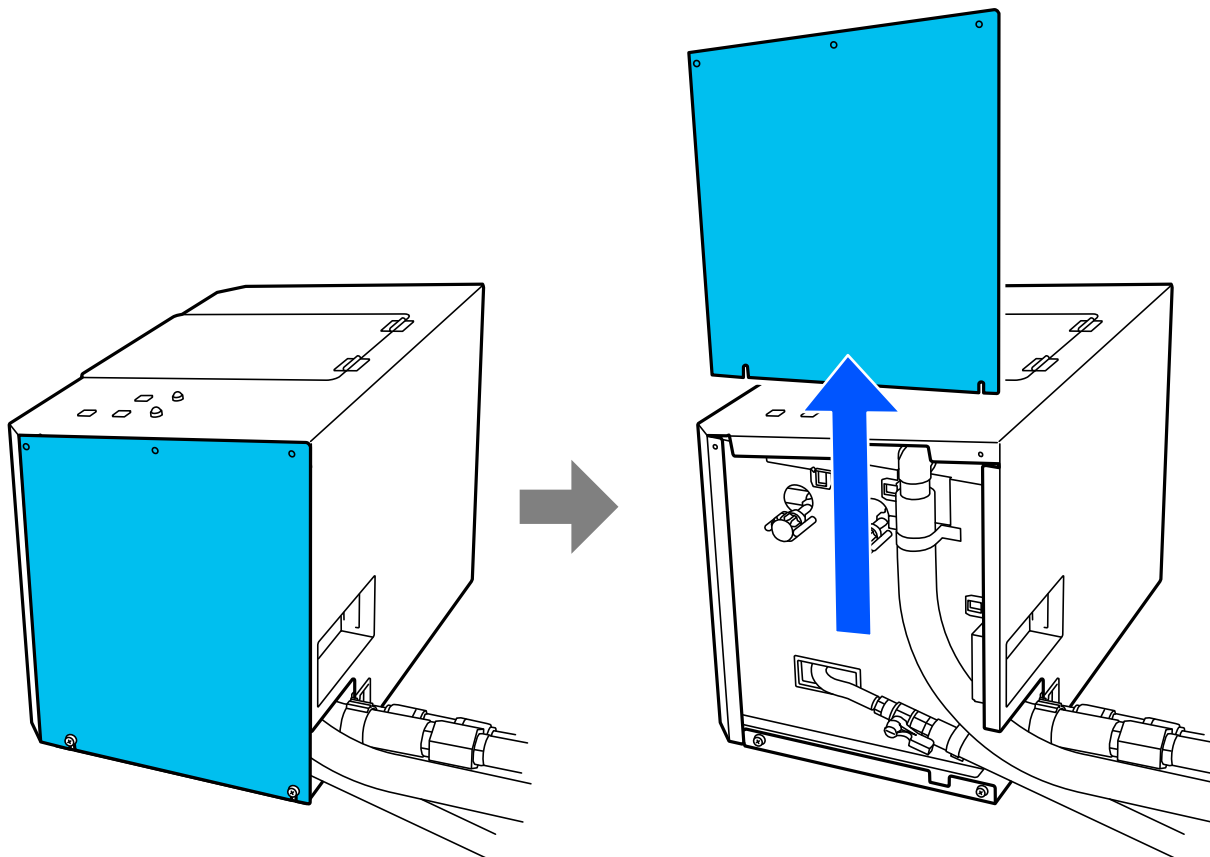

- 3 Close the manual valve.

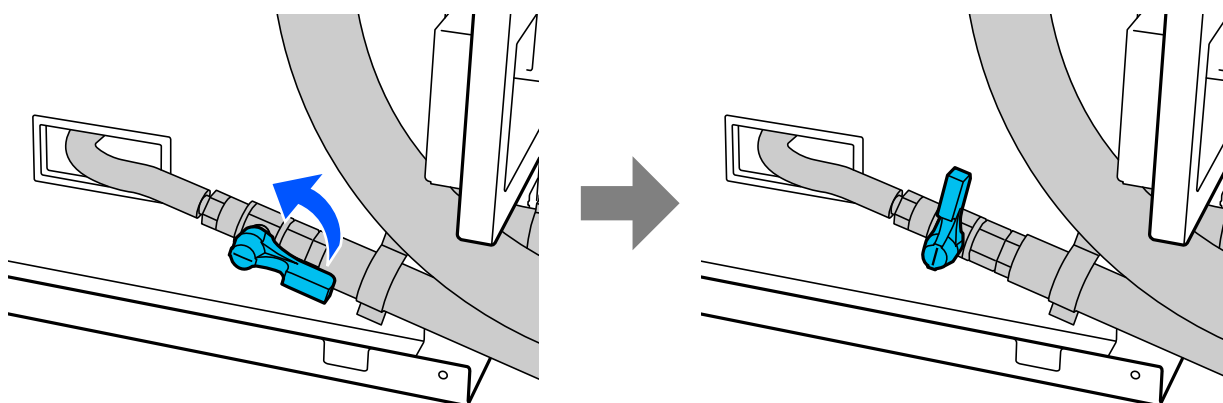

- 4 Open the valve supplying clean water to the printer's belt cleaning tank by aligning the flow rate adjustment markings.

Note:

The markings in the illustration may differ from the actual markings.

Problem Solver

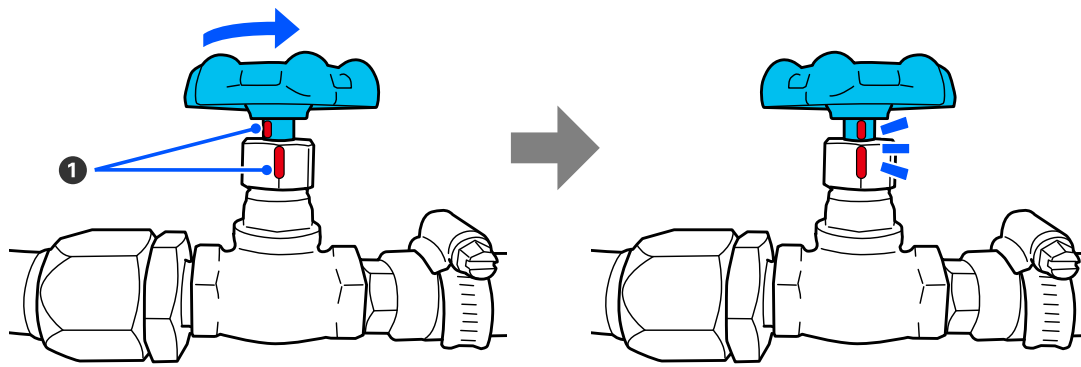

① Flow rate adjustment markings

5 Supply water to the printer's belt cleaning tank and make sure water is flowing into the cleaning tank.

Touch **Cleaning the Cleaning Tank** or **Belt Cleaning Unit Cleaning** from the **Maintenance** menu on the printer's control panel.

Check the message on the screen, and then touch the **Start** button. Water is supplied to the cleaning tank.

Once you have confirmed the water supply, touch the **Done** button to stop supplying water.

6 Attach the cover by aligning the notches on the cover with the two screws at the bottom on the right side of the product.

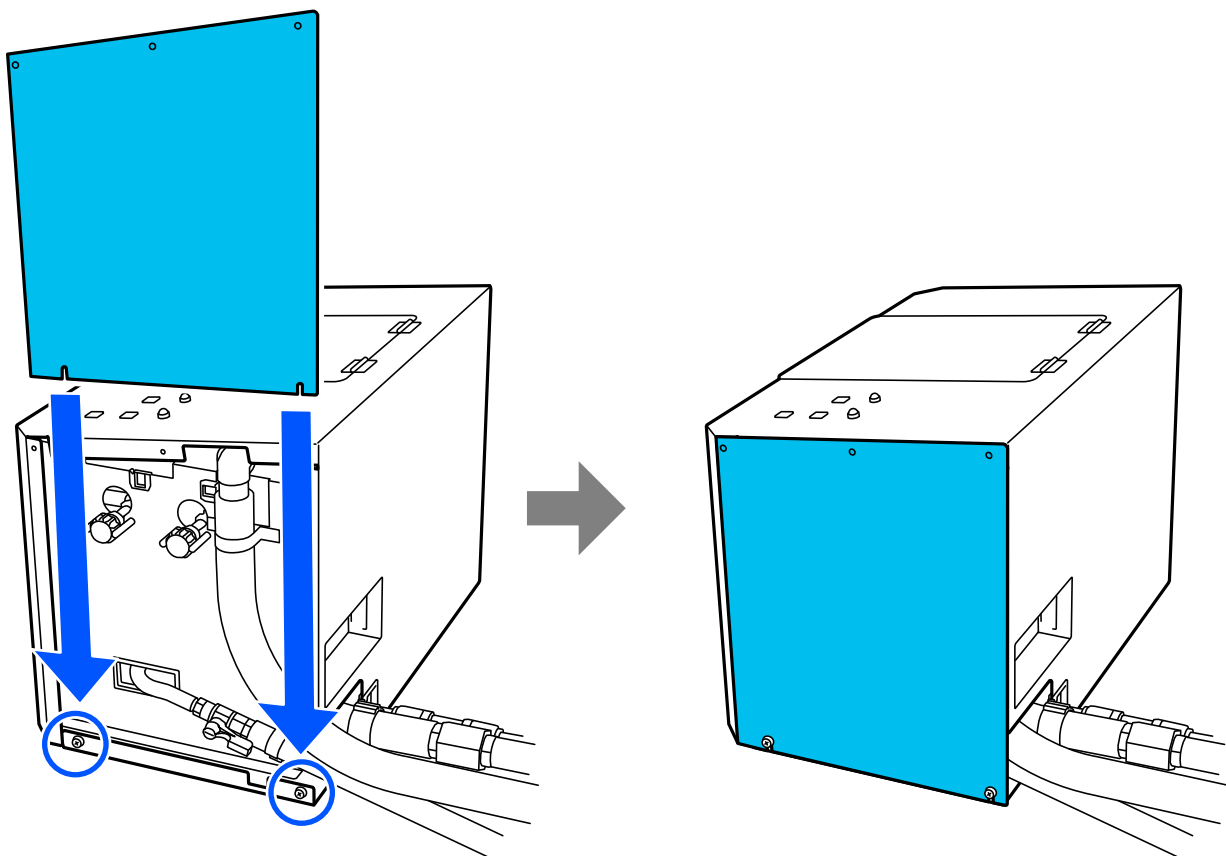

Problem Solver

- 7 Tighten the top three screws, and then tighten the bottom two screws.

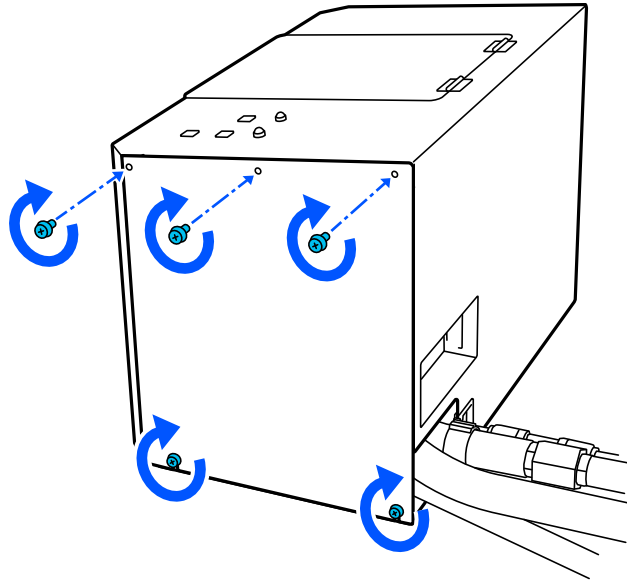

Appendix

Appendix

Specifications

Printer Specifications		
Temperature and humidity (without condensation)	When operating (during printer and product operation)	20 to 30°C (68 to 86°F), 40 to 60% rh
	When the power is on (during maintenance)	10 to 35°C (50 to 95°F), 35 to 80% rh
	When transporting	-20 to 60°C (-4 to 140°F), without condensation
Noise (when operating)		60 dB or less
Dimension		458 mm (W) x 300 mm (D) x 367 mm (H) (18.03 [W] x 11.81 [D] x 14.45 [H] inches)
Work space		Install the product within the work space specified for the printer being connected.
Weight (when the tank is empty)		13 kg (28.66 lb)

Factory facilities		
Water	Water supply hose	15 mm inner diameter
	Flow rate	65 to 150 L/h
	Water temperature	20 to 25°C (68 to 77°F)
Wastewater	Drainage hose	25 mm inner diameter